

The right choice for the ultimate yield!

LS ELECTRIC strives to maximize your profits in gratitude for choosing us as your partner.

Human Machine Interface

XGT PANEL

iXP Series

User Manual

**iXP50-TTA
iXP70-TTA
iXP80-TTA
iXP90-TTA**



Safety Instructions

- Read this manual carefully before installing, wiring, operating, servicing or inspecting this equipment.
- Keep this manual within easy reach for quick reference.

LS ELECTRIC

Before using the product...

To use the product safely and effectively, please read this instruction manual thoroughly before use.

- ▶ Please keep to the safety precaution, for it is to prevent accidents and potential danger from occurring.
- ▶ Safety precaution is classified into 'Warning' and 'Caution' and their meanings are as follows.

 **Warning** Violating the instruction may result in serious personal injury or death.

 **Caution** Violating the instruction may result in slight personal injury or product damage.

- ▶ The indicated illustrations on the product and in the manual have the following meanings.

 Be cautious, for danger may be present.

 Be cautious, for there is a possibility of an electric shock.

- ▶ After reading the instruction manual, keep it handy for quick reference.

Design Precautions



Warning

- ▶ **Install a safety circuit external to the HMI to protect the whole control system in case of external power supply trouble.**

Serious trouble may occur to the entire system due to erroneous output/operation of the HMI.

Design Precautions



Caution

- ▶ **In/output signal or communication cable should be at least 100mm apart from High-voltage/power wires.**

Otherwise, it may cause erroneous output/operation.

Installation Precautions



Caution

- ▶ **Use the HMI in an environment that meets the general specification contained in this manual or datasheet.**

Otherwise, it could result in electric shock, fire, erroneous operation or deterioration.

- ▶ **In case of much vibration in the installed environment, be sure to insulate the HMI from direct vibration.**

Otherwise, it could result in electric shock, fire or erroneous operation.

- ▶ **Be sure not to let foreign substances such as conductive debris inside the product.**

Otherwise, it could result in electric shock, fire or erroneous operation.

Wiring Precautions



Warning

- ▶ **Be sure to turn off the HMI and external power before wiring.**

Otherwise, it may result in an electric shock or damage to the product.



Caution

- ▶ **Wire correctly by checking each of the product's rated voltage and terminal layout.**

Otherwise, it may result in fire, electric shock or erroneous operation.

- ▶ **Tighten terminal screws with specified torque when wiring.**

If terminal screws are loose, it may result in short circuits, fire or erroneous operation.

- ▶ **Use the exclusive HMI 3-type grounding for the FG terminal.**

If not grounded, it may result in erroneous operation.

- ▶ **Be sure not to let any foreign substances such as wiring debris inside the module.**

Such debris may cause fire, damage or erroneous operation.

Startup and Maintenance Precautions

Warning

- ▶ **Do not touch the terminals while power is on.**
Otherwise, it may cause electric shock or erroneous operation.
- ▶ **Turn off the HMI and external power when cleaning or tightening the terminal.**
Otherwise, it may cause electric shock or erroneous operation.
- ▶ **Do not charge, disassemble, heat, short circuit, solder, etc. the battery.**
Mishandling the battery may cause overheating, crack, fire and may result in injury or fire.

Caution

- ▶ **Do not disassemble PCB from the product case or modify the product.**
Otherwise, it may result in fire, electric shock or erroneous operation.
- ▶ **Use cellular phone or walky-talky at least 30cm away from the HMI.**
Otherwise, it may result in erroneous operation.

Disposal Precaution

Caution

- ▶ **When disposing of this product or battery, treat it as industrial waste.**
Otherwise, it may cause poisonous pollution or explosion.

Revision History

Version	Date	Contents	Revised location
V1.0	'13.11	1. First Edition	-
V 1.1	'15. 01	1. Add iXP50-TTA/DC 2. iXP70/80/90 CF Card function is removed 3. Multimedia function is removed	2, 3, Appendix 2 1.2, 2, 3.2, 4.4, 5, 7, 9, Appendix 1 1, 2, 4
V 1.2	'20. 04	Revision due to the change of company name (LSIS → LS ELECTRIC)	
V 1.3	'20. 09	1. Change storage device function name	7. Storage function
V 1.4	'20. 12	1. RGB output function added	1.2, 2.1, 3.1

※ The number of User's manual is indicated the right side of the back cover.

© LS ELECTRIC Co., Ltd 2013

All Rights Reserved.

Chapter. 1 General Introduction..... 1-1~1-8

1.1 How to use the Instruction Manual 1-1
 1.2 Feature 1-3
 1.3 Terminology..... 1-8

Chapter. 2 System Configuration 2-1~2-11

2.1 Part Names 2-1
 2.2 System Configuration 2-6

Chapter. 3 Standard Specification 3-1~3-5

3.1 General Standards..... 3-1
 3.2 Function Standards..... 3-2

Chapter. 4 System Configuration 4-1~4-14

4.1 Touch Calibration 4-2
 4.2 Backlight Setting 4-3
 4.2.1 PIR sensor..... 4-4
 4.3 Date Time Setting 4-5
 4.4 Ethernet Setting 4-6
 4.5 Environment Setting 4-7
 4.6 Sound Setting 4-12
 4.7 XP-Remote Setting..... 4-13
 4.8 Buzzer Setting..... 4-14

Chapter. 5 Diagnostics..... 5-1~5-9

5.1 Screen Diagnosis 5-2
 5.2 Touch Diagnosis 5-3
 5.3 Backup Memory Diagnosis 5-4
 5.4 Flash Memory Diagnosis Function 5-5
 5.5 Serial Communication Diagnosis..... 5-6
 5.6 SD Card Diagnosis..... 5-8
 5.7 USB Memory Diagnosis..... 5-9

Chapter. 6 Viewing Information of PLC Connection Status 6-1~6-8

6.1 PLC Communication Configuration Settings 6-2
 6.2 Connection Information 6-3
 6.3 PLC Information..... 6-4
 6.4 History of PLC Error 6-4
 6.5 History of PLC Mode Conversion 6-5
 6.6 History of PLC Power 6-5
 6.7 History of PLC System 6-6
 6.8 N:1 Settings 6-7
 6.9 Program Monitor 6-8

Chapter. 7 Storage Function..... 7-1~7-9

7.1 General Introduction 7-1
 7.2 Project Download [Project (USB/SD -> HMI)]..... 7-2
 7.3 Project Upload [Project (HMI -> USB/SD)] 7-3
 7.4 Project Upload Project File(.XPD) (HMI -> USB/SD) 7.4
 7.5 Updating the device using a storage device 7-5
 7.6 Storage device selection function [Select USB] 7-6
 7.7 Storage device selection function during monitoring..... 7-7

Chapter. 8 XGT Panel S/W Update..... 8-1

8.1 General Introduction 8-1

Chapter. 9 File Backup through External Storage Equipment 9-1~9-8

9.1 Path Structure in case of File Backup..... 9-1
 9.2 Operation setting when there is no space for backup..... 9-4
 9.3 Structure of path of video file and video capture files 9-4
 9.4 Monitoring Connection Status of External Storage Equipment 9-6
 9.5 Safety Removal Switch 9-7

Chapter. 10 Installation and Wiring..... 10-1~10-8

10.1 Installation 10-1
 10.1.1 Installation environment 10-1
 10.1.2 Notice in handling..... 10-2
 10.1.3 Notice in installing the panel 10-2

10.2 Wiring 10-5
 10.2.1 Power wiring 10-5
 10.2.2 Ground wiring 10-8

Chapter. 11 Maintenance 11-1~11-3

11.1 Maintenance 11-1
 11.2 Daily Maintenance 11-1
 11.3 Periodical Maintenance 11-2

Chapter. 12 EMC Standard Certification 12-1~12-2

12.1 Requirement for EMC Standard Certification 12-1
 12.1.1 CE standard certification 12-1
 12.1.2 MIC standard certification 12-2
 12.2 Requirement for Low Voltage Command Suitability 12-2
 12.2.1 Standard certification for XGT Panel 12-2
 12.2.2 Selection of XGT Panel 12-2

Appendix 1. Troubleshooting Appendix 1-1~Appendix 1-8

1. Type of Problem Appendix 1-1
 2. Problem when Starting Appendix 1-2
 3. Reaction Problem when Touching Appendix 1-3
 4. Display Problem of Figure and Object Appendix 1-4
 5. Communication Problem Appendix 1-7
 6. SD/USB Removal of Memory Card Appendix 1-8

Appendix 2. Dimension Appendix 2-1~ Appendix 2-3

Chapter 1. General Introduction

1.1 How to use the Instruction Manual

This instruction manual provides information such as specification, how to use, etc. of the product needed to operate iXP series of XGT Panel.

iXP series is characterized as follow;

Item	symbol	Contents	Remarks
(A) LCD Size	50	21cm (8.4")	
	70	26cm (10.4")	-
	80	31cm (12.1")	-
	90	38cm (15")	-
(B) LCD Type	B	STN Mono	Not available
	T	TFT Color	-
(C) Touch Type	T	Touch	-
(D) iXP Type	A	Advance	-
	M	Multimedia	Available later
(E) Power type	AC	AC 100-240V	-
	DC	DC 12/24V	iXP50 DC24V Only

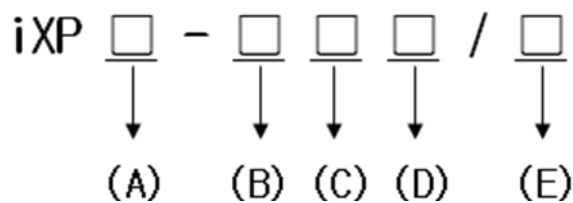

The user manual's configuration is as follows.

Sequence	Category	Contents
Chapter 1	General Introduction	It describes this manual's configuration, product's feature and term.
Chapter 2	System Configuration	It describes feature and system configuration of each XGT Panel.
Chapter 3	Standard Specification	It describes XGT Panel's general and function specification.
Chapter 4	System Configuration	It describes XGT Panel's system configuration.
Chapter 5	Diagnostics	It describes XGT Panel's self-diagnosis.
Chapter 6	Viewing information of PLC Connection Status	It describes the way on connection status information of PLC which is connected with XGT Panel.
Chapter 7	Transmission of Project from USB Storage Device	It describes the way to execute the project by using USB/SD storage device.
Chapter 8	XGT Panel SW Update	It describes the way to update engine at XGT Panel.
Chapter 9	Backup files by using Storage Devices	It describes the way to backup recipe, logging and etc. files by using storage devices.
Chapter 10	Installation and Wiring	It describes an installation, wiring and caution for reliability of PLC system.
Chapter 11	Maintenance	It describes inspection category and method for long normal operation of PLC system.
Chapter 12	EMC Standard	It describes system configuration for EMC standard.
Appendix 1	Troubleshooting	It describes a variety of error contents and measure.
Appendix 2	Dimension	It describes the dimension of XGT Panel.
Appendix 3	Warranty and Environment Policy	-

Remark

This manual doesn't describe connection with XP-Builder and PLC. For their own function, Please refer to the related manuals.

1.2 Feature

iXP series has the following features.

(1) Various types of external interface

(a) Supporting various storage media of USB and SD card, it maximizes the customer's usability. Multimedia type provides interfaces of video input, audio input, video output, and audio output so as to add the functions needed to exert high performance. Extended interface designed to stack maximum three layers allows mounting a variety of communication cards on it. In addition, the right part of extended interface is designed so as to mount VM module that allows inputting 4-channel video.

● iXP50

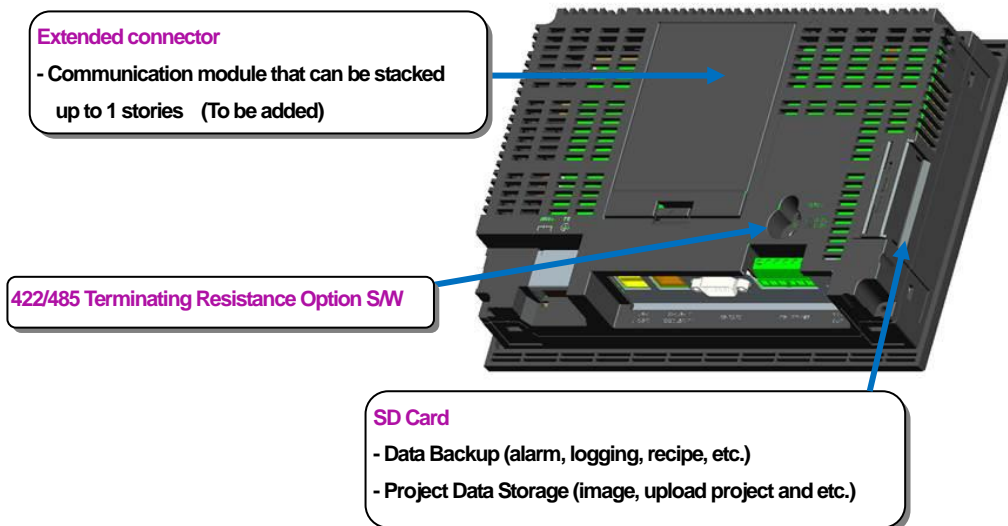

● iXP70/80/90

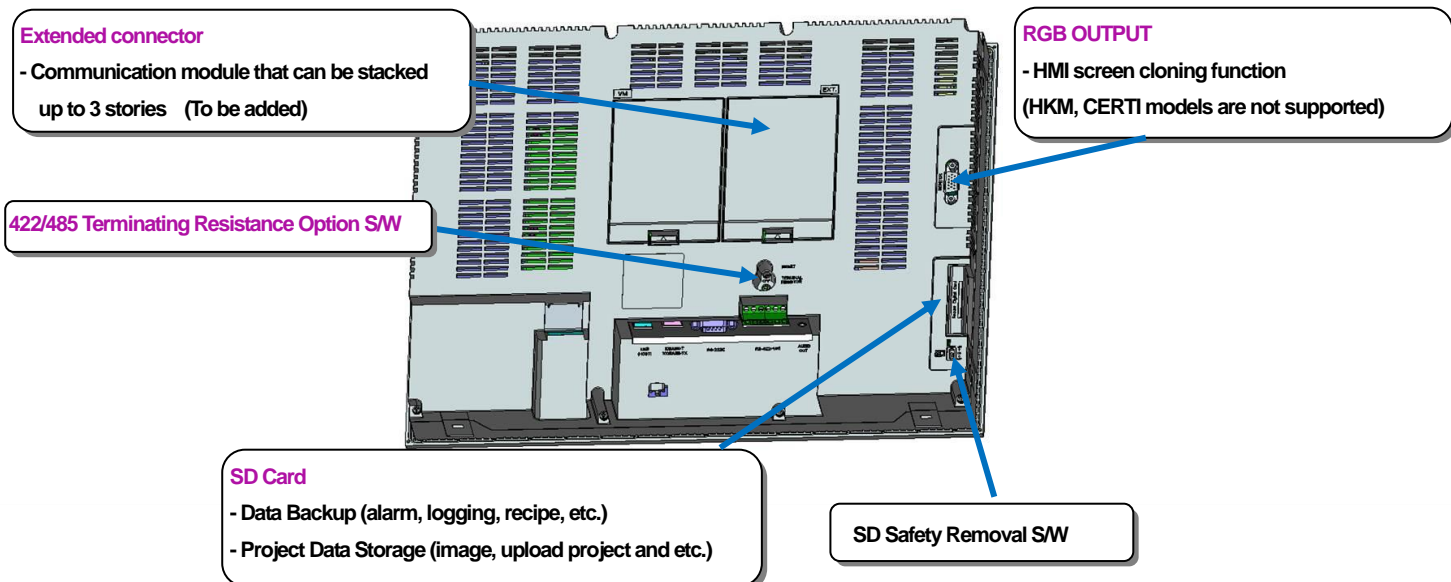

(b) Presence sensor is placed at the front upper side so as to control backlight power source as it detects the presence. This enables the user to turn on/off backlight either by touch or as it detects a movement of human body or not, and thereby contribute to energy saving. In addition, one each channel of USB Host and Device is placed at the front side so that the user can access with ease. That is, USB device is provided in such a method of basic communication connection with PC so that the user can easily download the project through XP-Builder. Furthermore USB HOST 1 Channel located at the front side allows the user to insert and remove the storage media with ease.

● iXP50

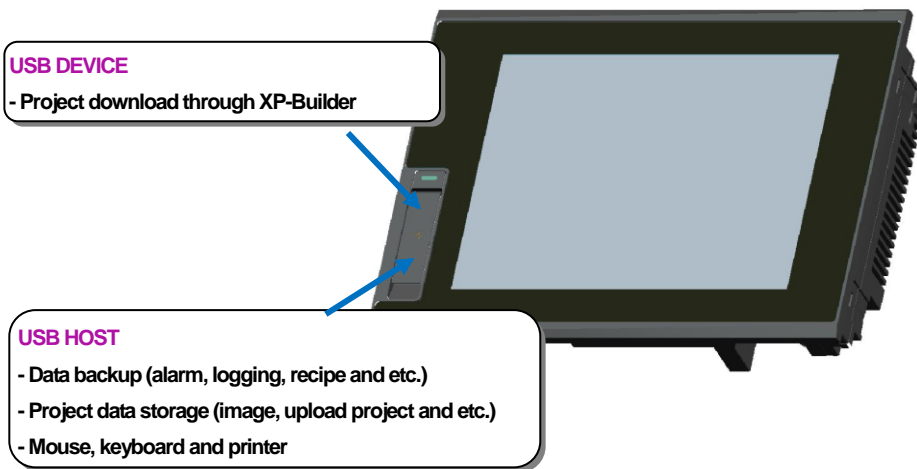

● iXP70/80/90

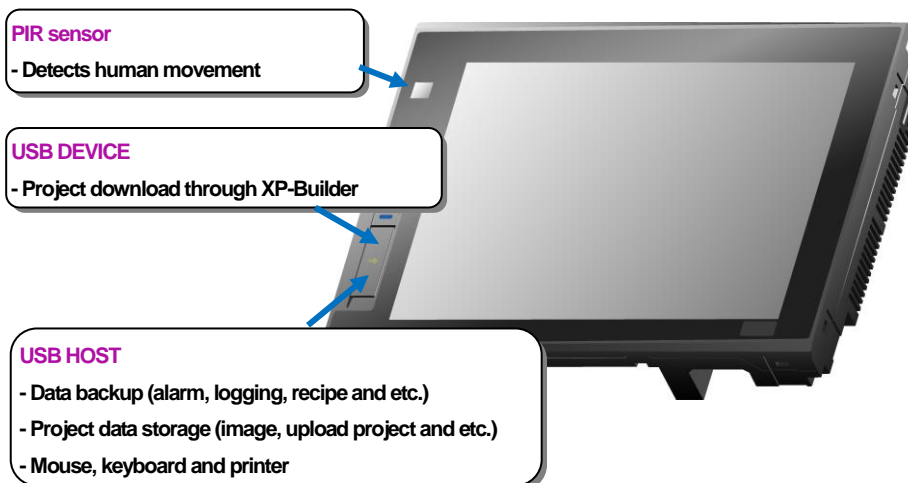

- (c) Various communication connectors are placed at the lower side so that it can be connected in a variety of types with the control device such as PLC, inverter, etc. With two channels of USB HOST attached, it provides total 3 USB Hosts including one channel at front side. This enables the user to diversely connect USB-based peripheral device that uses mouse, key board, printer, etc. as well as for the purpose of backup.
- Through RS-232C, RS-422/485, Ethernet (10Base-T /100Base-TX) communication, it can be connected with control device.

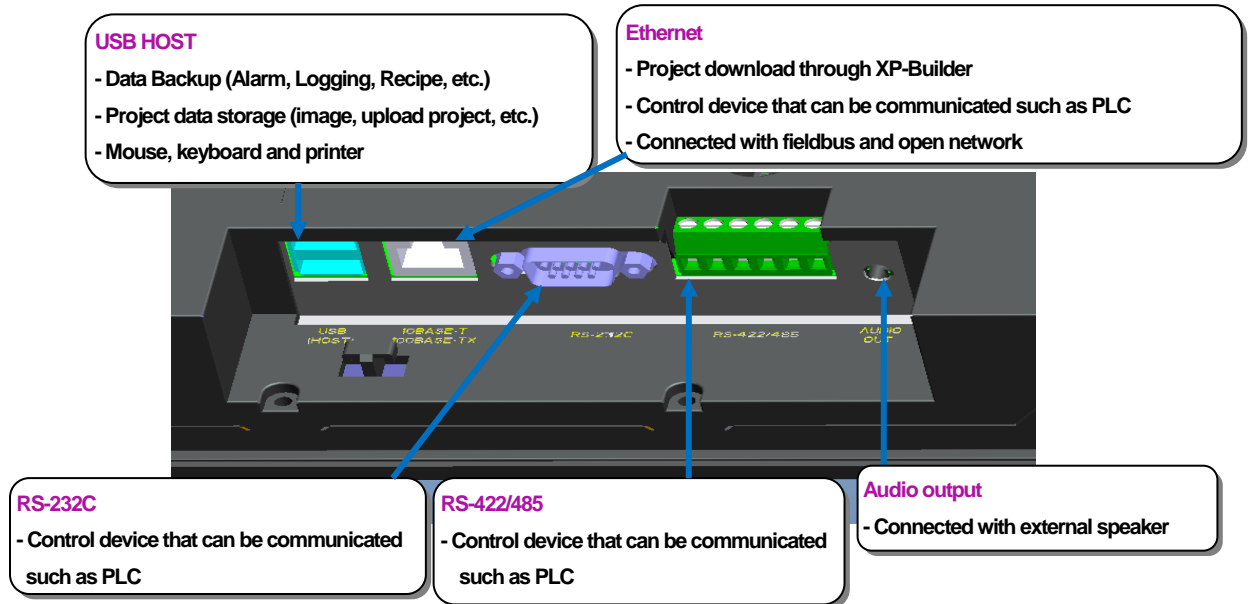

(2) Based on Windows CE

(a) Adoption of Microsoft Company's Windows CE

- Windows CE 6.0

(b) Advantage

- It provides stable software capacity by using Microsoft Company's platform.
- It can process diverse function simultaneously.
- It provides diverse interface including Ethernet, USB and SD card.
- The user interface including mouse and keyboard can be connected.
- It has high flexibility like computer software.
- Fast reaction is available when adding new equipment.
- Wide data sharing and management with upper system is available. (Later)

(3) Improvement of project transmission time

- (a) It provides Ethernet which is faster than RS-232C.

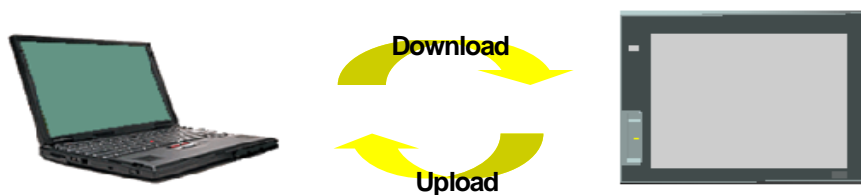

(b) It provides the transmission function from USB storage device.

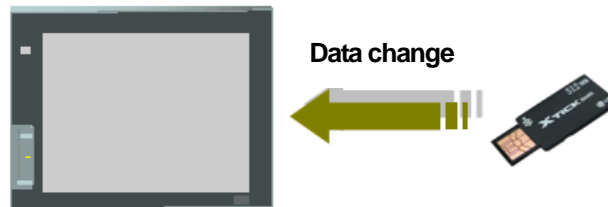

(4) High quality screen

(a) It provides the high quality screen and clearness by high quality LCD.

- It adopts TFT LCD which supports the 24-bit Color.

(b) It provides diverse graphic type.

- It is available to express precisely and actually.
- It provides the simple moving function with GIF support.

(5) Analog touch Panel

(a) It adopts analog (resistor film method) Touch Panel.

- Visibility is improved without the grids.

(b) It provides high touch resolution.

- It can control Touch Panel precisely.

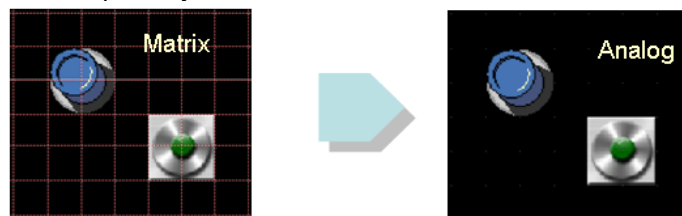

(6) Multilingual and diverse font

(a) It supports the multilingual function.

- It transmits the Windows/User font used in computer to XGT Panel.
- Additional language development is not necessary.
- Multilingual language is an advantage of Windows CE.

(b) It can express four kinds of language simultaneously.

- It can express 8 kinds of language simultaneously.
- Language switching is available by using special switch during operation.

(c) It can provide the various fonts.

- Various expressions are available by using the Windows/User font.
- Font size and type can be adjusted freely.

(7) Advanced function

(a) Alarm function

- The History alarm can be classified alarm group and alarm list and selected alarm can be expressed by alarm search.
- The Flow alarm indicates current or the latest alarm at the bottom of screen.
- The System alarm indicates the important problems from operation.
- It provides 256Kbyte areas for backup.

(b) Logging function

- It provides conditional logging according to device condition and continuous periodic logging which operates periodically according to time and device status.
- It provides 512Kbyte areas for backup.
- Backup into SD card or USB storage device is available.
- Backup data's type is stored in Excel, it is easy to use.

(c) Recipe function

- It provides READ/WRITE function.
- It provides 128Kbyte areas for backups. [General recipe: 255 (255 blocks and set up to 10,000 double word for each one of them), File recipe: 5000]
- Backup into the SD card or USB storage device is available.
- Backup data's type is stored in Excel, it is easy to use.

(d) Scheduler function

- It can be set up to Max. 32.

(e) Print function

- It provides a Screen/Alarm print function.
- It can be printed by USB printer.

(f) Script function

- It provides more flexible function by user Script.
- It can be diversely applied to such as including Global/Object/Screen indication and so on.

(g) Providing sound output function

- It basically provides audio output function in all the types.
- It allows connecting with amp built-in external speaker. With the sound function set, it enables to output a variety of WAV files.

(h) Providing video input function (Multimedia type only)

- Analog camera allowing input of signals such as NTSC, PAL, SECAM, etc. can be connected using coaxial cable.
- It provides preview function that allows watching video input data, and record/play functions as well.
- It provides the function that stores video input data for maximum 120 seconds and then play it using a specific trigger.

(i) Providing sound input function. (Multimedia type only)

- Sound source can be input through MIC/Line-IN, which can be selected by S/W.
- Sound input data is stored together when recording the video.
- It provides an optional function of outputting the sound input data to the speaker.

(j) Providing video output function. (Multimedia type only)

- It provides the function of outputting HMI screen to PC in HMI resolution by connecting it to the PC using RGB cable.

(8) Stable product suitable for international standards

- (a) CE, KC standard acquisition
- (b) UL(cUL) standard acquisition

1.3 Terminology

It describes terms used in this manual.

Term	Definition	Remarks
Module	A standard element that has a specified function which configures the system. Devices such as I/O board, which inserted onto the mother board or base unit.	Ex.) CPU module Power module, I/O module
Unit	A single module or group of modules that perform an independent operation as a part of PLC system.	Ex.) Basic unit, Extension unit
PLC system	System consisted of PLC and peripheral device which can be controlled by user program.	-
XP-Builder	Software used to write and edit the project.	-
XP-Manager	It is the software for edition, download, monitoring to realize data communication between XGT Panels through XP Link with online control function.	
XP-Remote	Software used to remote monitor and control the XGT Panel	
Cnet module	Computer Link	-
FEnet module	Fast Ethernet Network	-
RTC	Abbreviation of 'Real Time Clock'. It is used to call general IC that contains clock function.	-

Chapter 2 System Configuration

Characteristic of each iXP series and its system configuration are as follow;

2.1 Part Names

2.1.1. iXP50 -TTA/DC

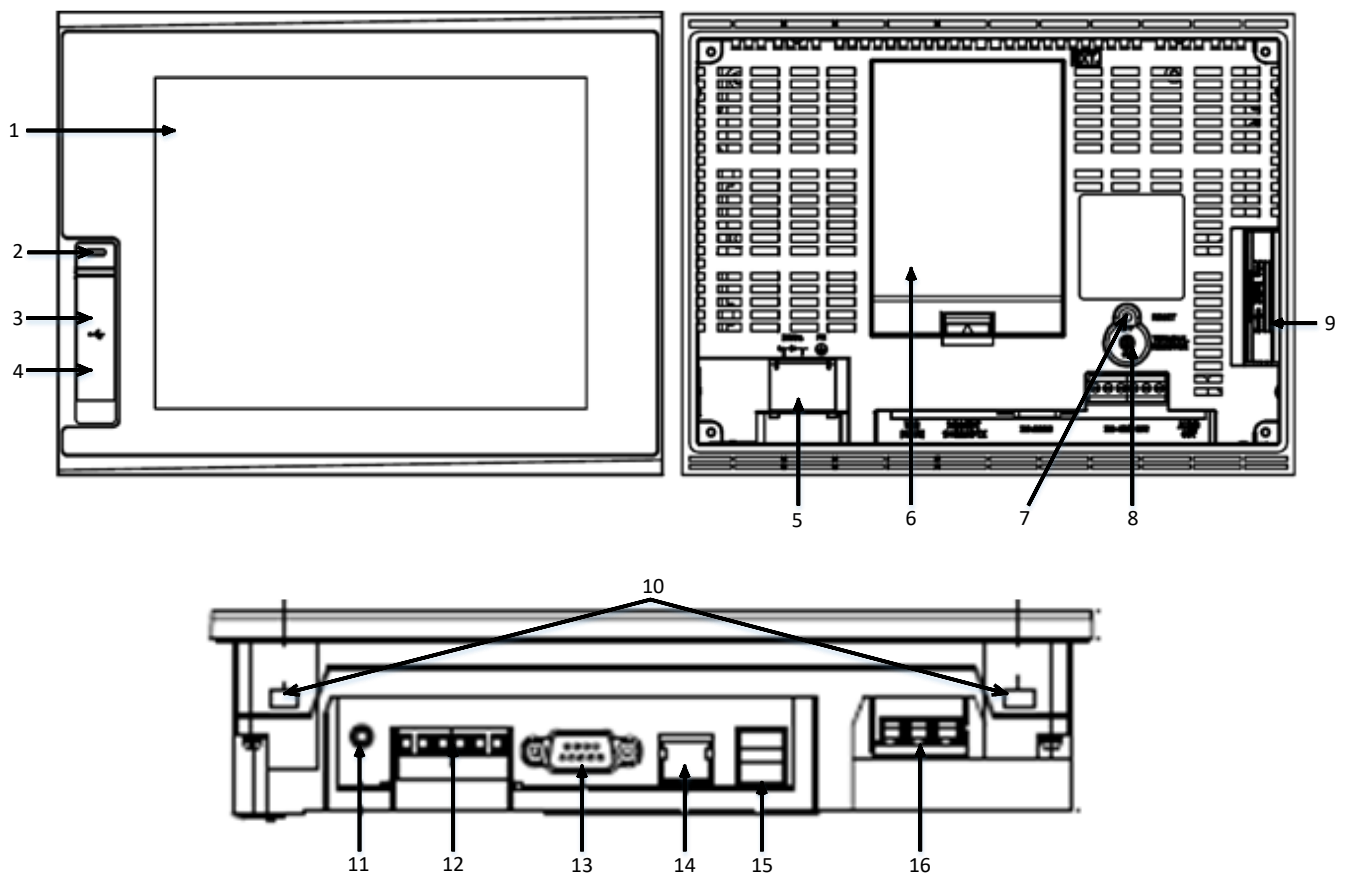

No	Name	Description
1	Front Part	1) Analog Touch Panel: Input by user's touch 2) LCD: Screen indication
2	Power status LED	Indicating the state of device (On: Green)
3	USB Device	1) Logging/Recipe/Screen Data Backup 2) Send project data and XP-Run time 3) Receive back data and project file

No	Name	Description
4	USB Interface	Composed of three ports (Front side 1 port, Lower end 2 ports) 1) USB Memory Connection: Backup of data such as alarm/logging/recipe and storage of screen data
15		2) USB Memory Connection: Send/Receive project data, Send XP-Runtime 3) User's Interface Connection: Using mouse/keyboard 4) Printer connection: Printing function
5	Power Terminal Cover	Prevention from electric shock
6	Extended Interface	Communication, I/O Option Module 3 Units Mounted → Optional board to be developed later
7	Reset Switch	Hardware Reset Switch
8	RS-422/485 Terminating Resistance Switch	RS-422/485 Terminating Resistance On/Off → See Communication Instruction Manual 2.5.1 Switch
9	SD Card Interface	1) Backup of data such as alarm/logging/recipe and storage of screen data 2) Send/Receive project data, Send XP-Runtime 3) Window CE OS Update Function (Can be used with DIP SW set)
10	Panel Mounting Part	Fixing XGT Panel on the panel using bracket
11	Audio Output	1 channel Audio Output
12	RS-422/485 Connector	RS-422/485: PLC or Control Device Communication
13	RS-232C Connector	RS-232C: PLC or Control Device Communication
14	Ethernet Terminal	Ethernet: 10Base-T / 100Base-TX 1) Send Project Data 2) Receive backup data and project file 3) Send XP-Runtime 4) PLC/Control Device Communication
16	Power Terminal	Composed of Power Input and FG Terminal

Chapter 2 System Configuration

2.1.2. iXP70 (80/90)-TTA/AC (DC)

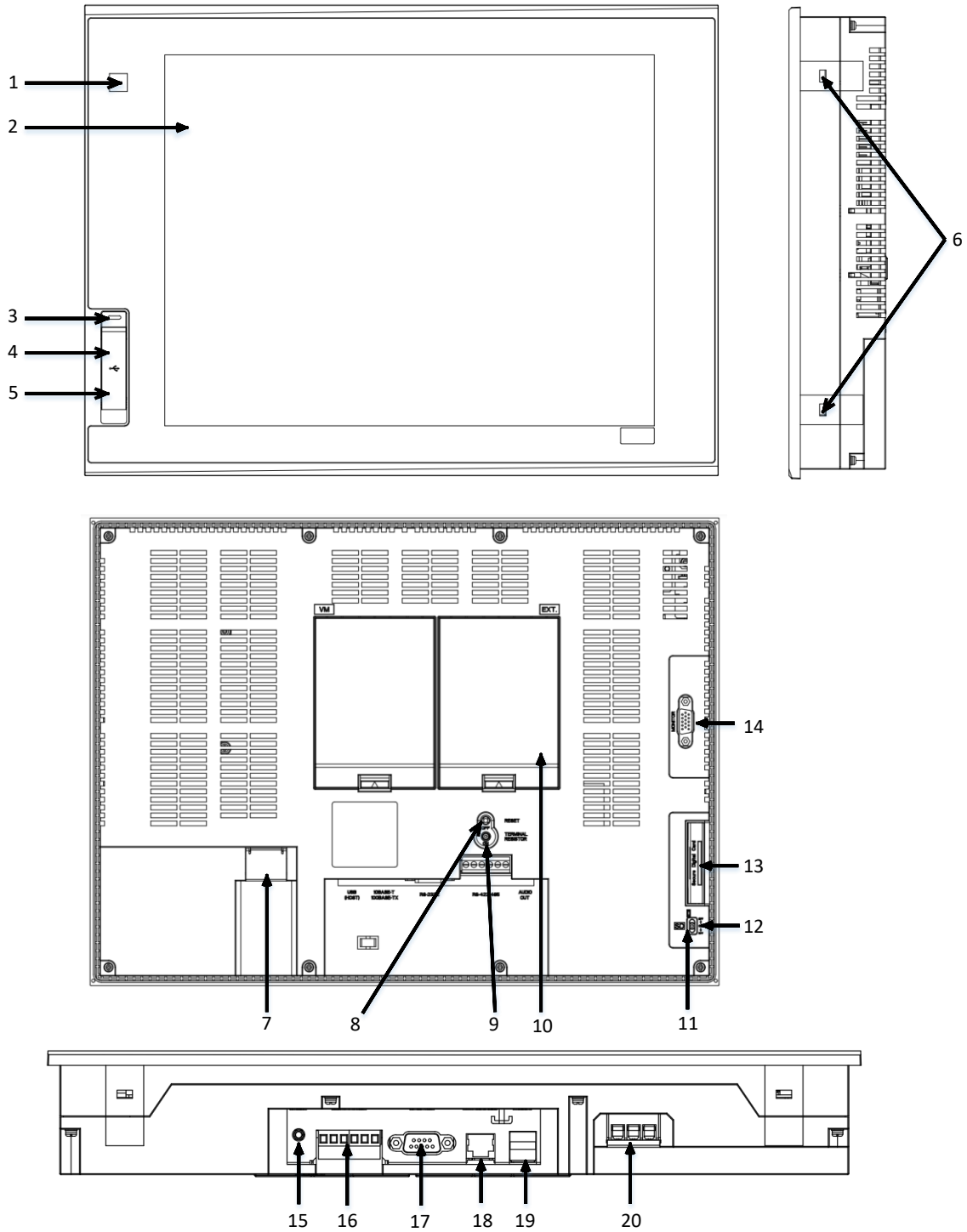

No	Name	Description
1	PIR sensor	Sensor that detects human movement

No	Name	Description
2	Front Part	1) Analog Touch Panel: Input by user's touch 2) LCD: Screen indication
3	Power status LED	Indicating the state of device (On: Green)
4	USB Device	1) Logging/Recipe/Screen Data Backup 2) Send project data and XP-Run time 3) Receive back data and project file
5	USB Interface	Composed of three ports (Front side 1 port, Lower end 2 ports) 1) USB Memory Connection: Backup of data such as alarm/logging/recipe and storage of screen data 2) USB Memory Connection: Send/Receive project data, Send XP- Runtime 3) User's Interface Connection: Using mouse/keyboard 4) Printer connection: Printing function
19		
6	Panel Mounting Part	Fixing XGT Panel on the panel using bracket
7	Power Terminal Cover	Prevention from electric shock
8	Reset Switch	Hardware Reset Switch
9	RS-422/485 Terminating Resistance Switch	RS-422/485 Terminating Resistance On/Off → See Communication Instruction Manual 2.5.1 Switch
10	Extended Interface	Communication, I/O Option Module 3 Units Mounted → Optional board to be developed later
11	SD Card LED	SD card installation check
12	SD HOT SWAP switch	SD Card Safety Removal Switch
13	SD Card Interface	1) Backup of data such as alarm/logging/recipe and storage of screen data 2) Send/Receive project data, Send XP- Runtime 3) Window CE OS Update Function (Can be used with DIP SW set)
14	RGB OUTPUT	Clone mode screen output
15	Audio Output	1 channel Audio Output
16	RS-422/485 Connector	RS-422/485: PLC or Control Device Communication
17	RS-232C Connector	RS-232C: PLC or Control Device Communication
18	Ethernet Terminal	Ethernet: 10Base-T / 100Base-TX 1) Send Project Data 2) Receive backup data and project file 3) Send XP- Runtime 4) PLC/Control Device Communication
20	Power Terminal	Composed of Power Input and FG Terminal

Note

- (1) For further details on connection of communication, please refer to Communication Instruction Manual.
- (2) For further details on installation, please refer to the Chapter 10.
- (3) The extended interface feature will not be supported starting September 2017.

When you unpack the produce box to use XGT Panel, you can find prevention switch mounting on the device setting switch that prevents battery discharge. Device setting switch consists of 6 switches. Of them, 3rd switch has battery discharge preventing function. With this prevention switch upward to A, it starts operating backup function.

(1) iXP50-TTA



No.3 Switch (BACK UP BATTERY On) to be located toward A

(2) iXP70/80/90-TTA



No.3 Switch (BACK UP BATTERY On) to be located toward A

Device setting switch is made up of followings;

Pin Number	Configuration	Function
No.1	Reserved	
No.2	A Config.	NAND FLASH is used for booting (default)
	B Config.	NAND FLASH is not used for booting
No.3	A Config.	BACK UP BATTERY On
	B Config.	BACK UP BATTERY Off (default)
No.4	A Config.	Watchdog function On (default)
	B Config.	Watchdog function Off
No.5	A Config.	SD Card is used for booting
	B Config.	SD Card is not used for booting (default)
No.6	A Config.	USB, UART is used for booting
	B Config.	USB, UART is not used for booting (default)

Be sure not to flip switches Nos. 2, 5, and 6 toward A at the same time. Normally it is recommended to set switch No.2 toward A. If you boot it with switches Nos. 2, 5, and 6 to A at the same time, it may cause malfunction of booting sequence resulting in white screen and abnormal booting.

2.2 System Configuration

(1) PC and its Construction

In order to use XGT Panel, it is necessary for XP-Builder to prepare project data and transmit it to XGT Panel. Normally you can connect with XGT Panel using USB 2.0 Device. Maximum Communication speed is 480Mbps.

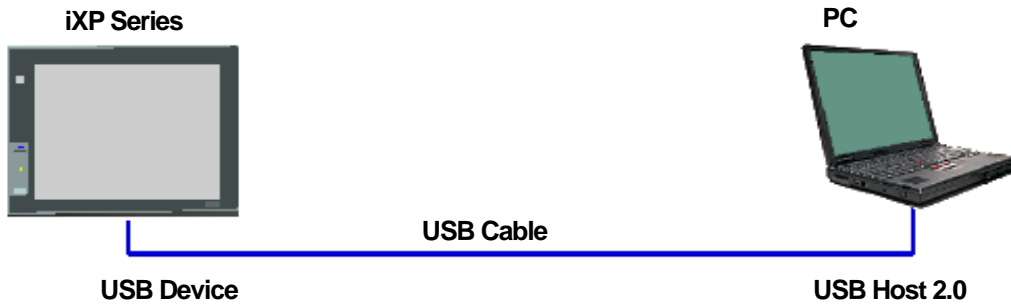

With Ethernet in use, you can transfer project data more quickly.
 With LAN environment built in the following configuration, you may use it more easily and effectively.

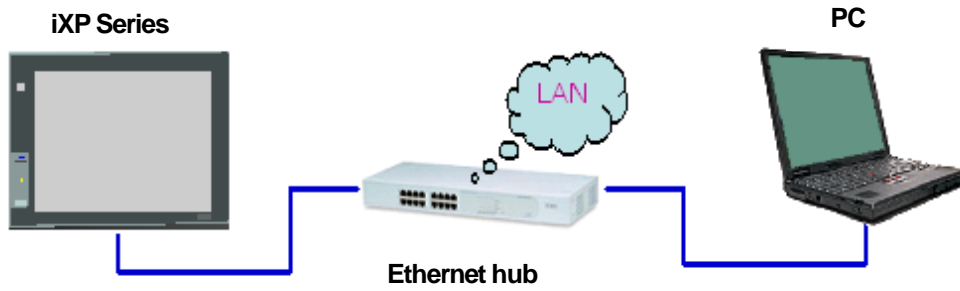

1:1 connection will be supported just in case LAN environment is not built.

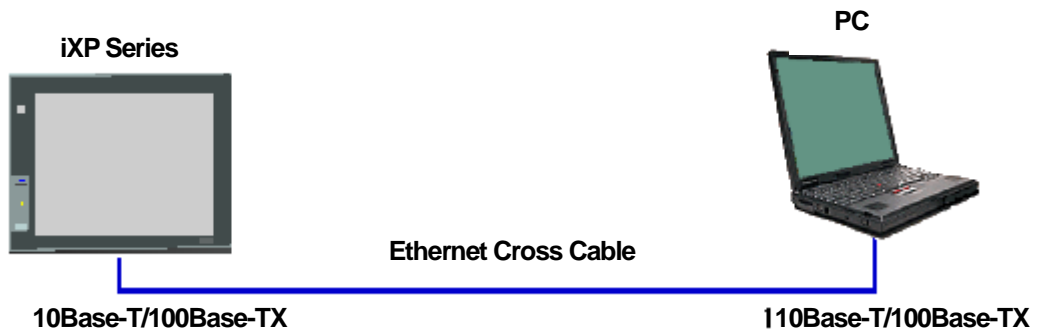

If it is impossible to transfer project data using Communication, you can use USB storage device and SD memory Card. For more information, please look at the Chapter 7 and XP-Builder User's Manual.

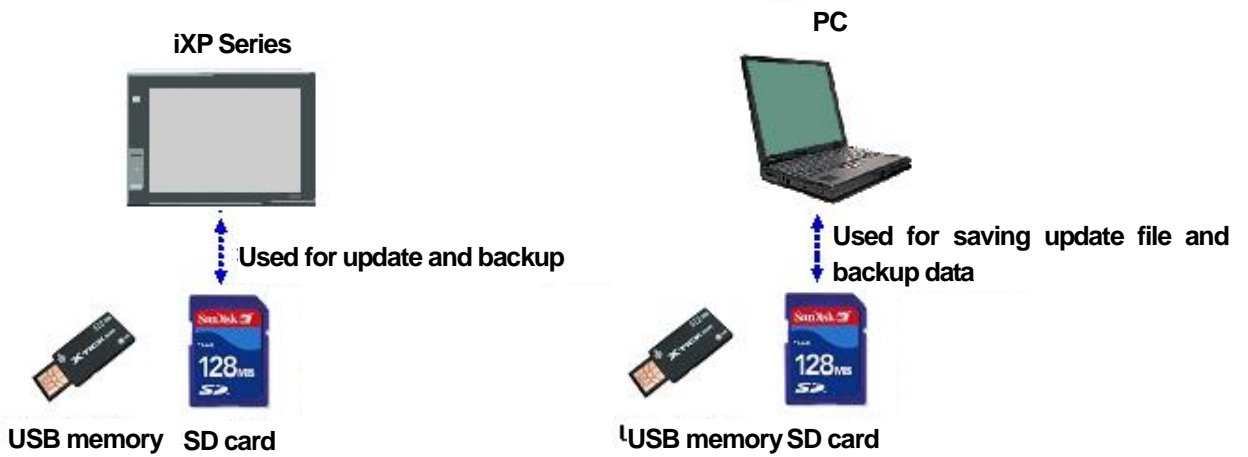

(2) PLC and its Construction

With RS-232C cable in use, you can connect it up to 15m in a direction 1:1 connection.

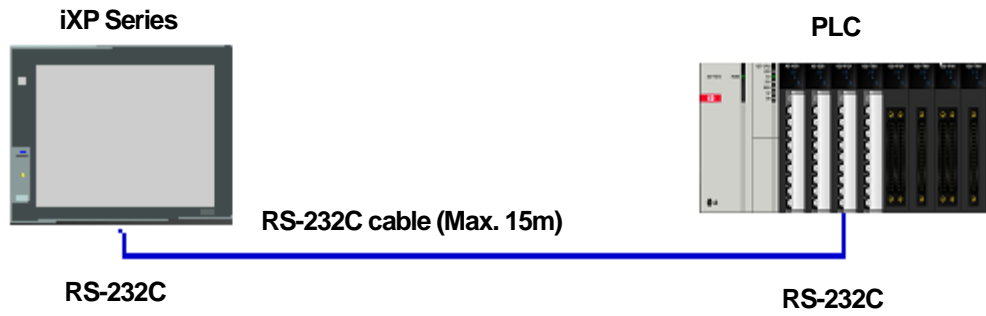

With RS-232C to RS-422/485 Converter in use, you can connect it in extended length. But, it doesn't support 1: N connection.

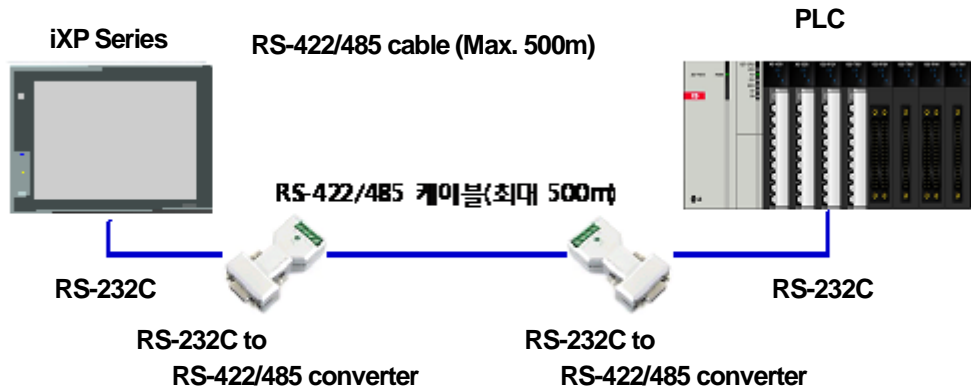

With RS-232C wireless converter in use, it enables communication between XGT Panel and control device

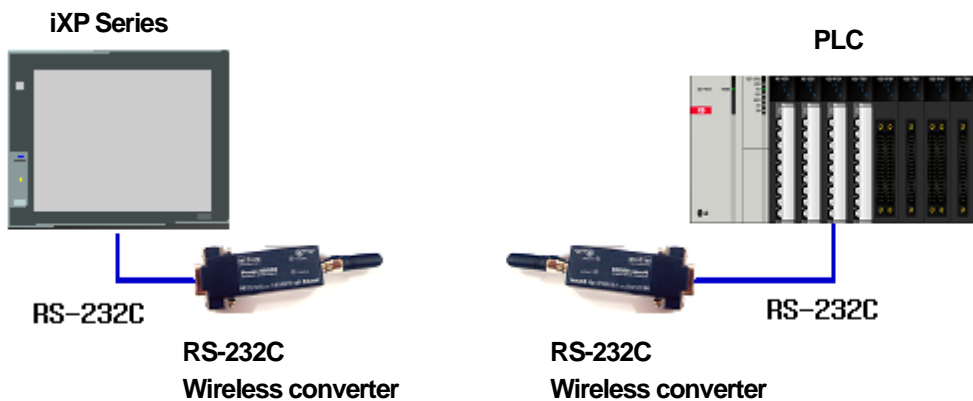

With RS-422/485 cable in use, it enables connections such as 1:1, 1: N, N: 1 and N: M up to 500m.

Chapter 2 System Configuration

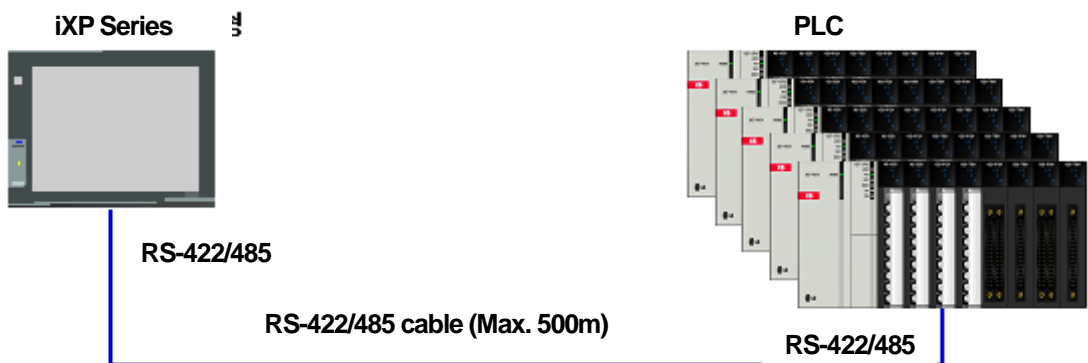
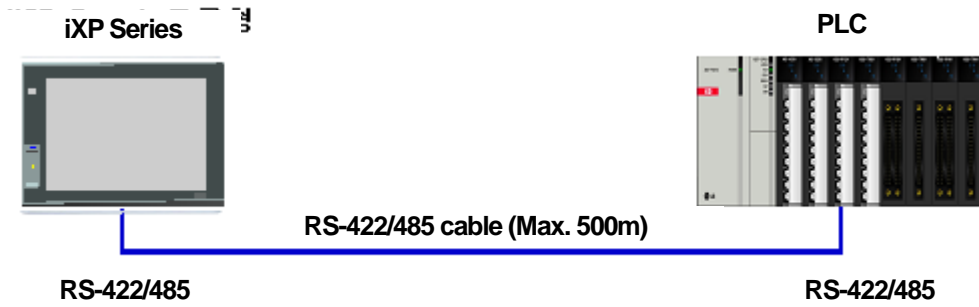

With N: 1 and N: M in connection, it enables connection in a RS-485 method.

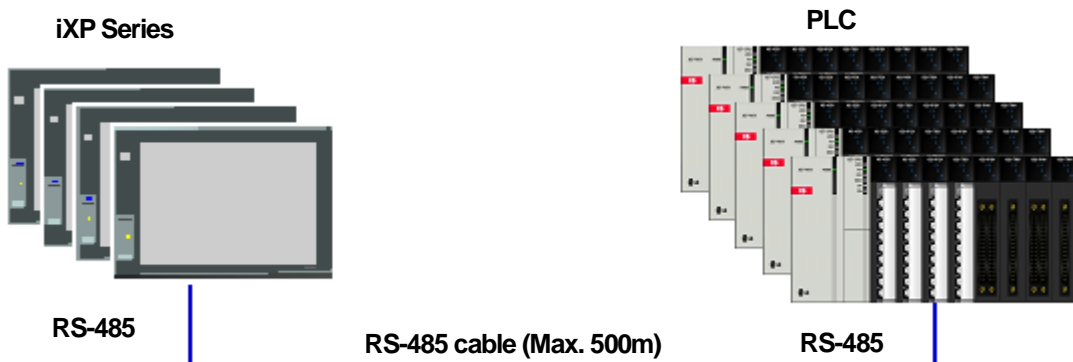
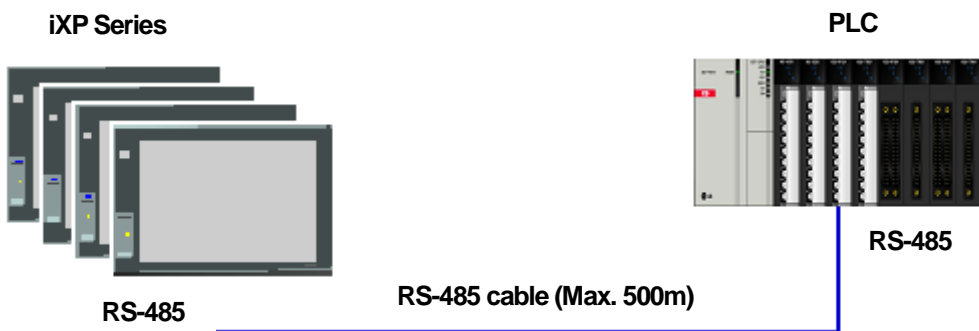

It enables communication configuration using LAN through Ethernet switch hub and communication configuration using a direct cable.

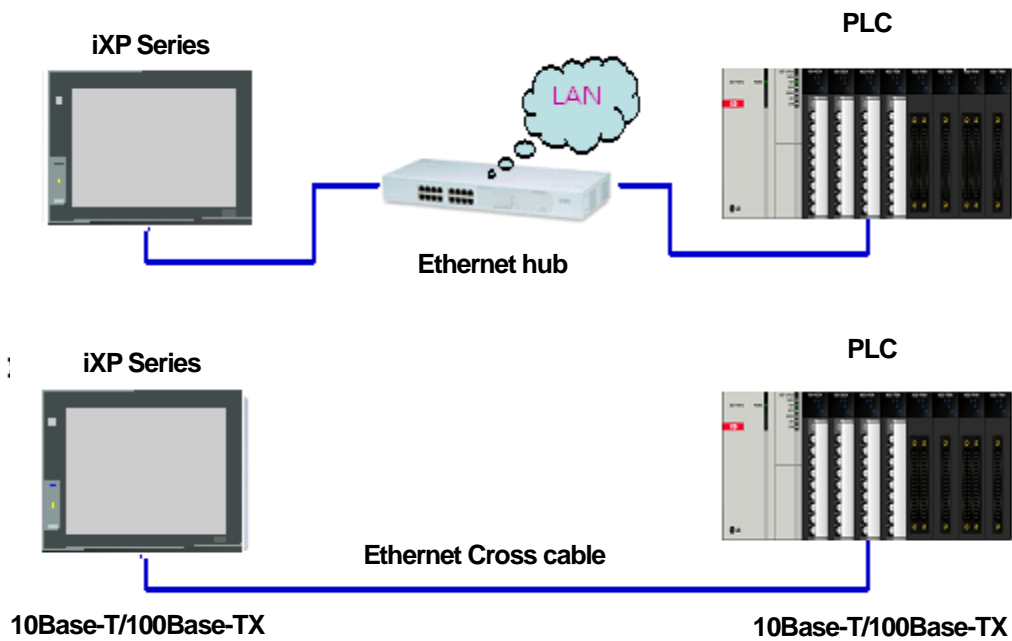

With LAN in use, it enables to connect multiple numbers of XGT Panels with the control device. It also enables remote control from PC and operation through a data server.

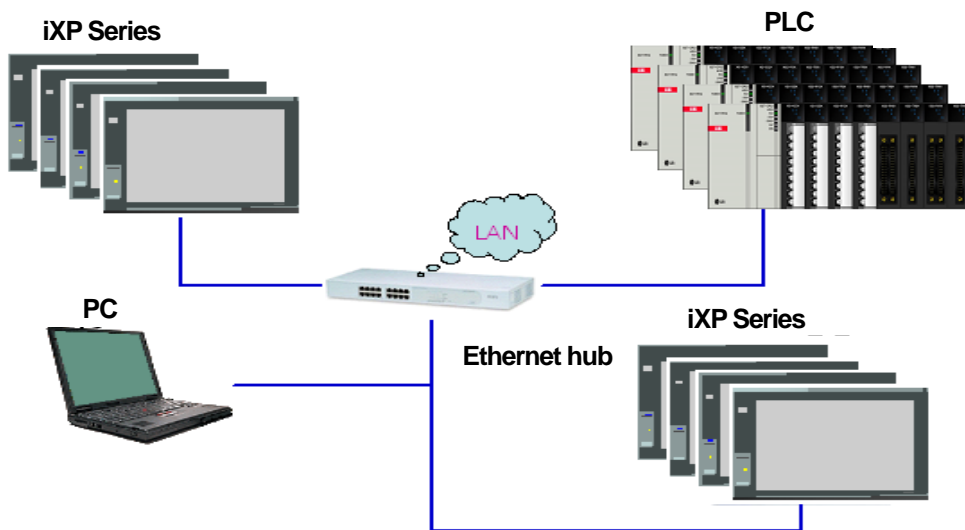

Note

- (1) For how to make Ethernet cable, please see the Communication User's Manual.
- (2) For how to transfer project, please see XP-Builder User's Manual.

Chapter 3. Standard Specification

3.1 General Standards

IXP Series general standard is as follows.

No.	Category	Standard			Related standard	
1	Ambient operating temperature	0°C ~ +50°C			-	
2	Storage temperature	-20°C ~ +60°C			-	
3	Operating humidity	10 ~ 85%RH, non-condensing.			-	
4	Storage humidity	10 ~ 85%RH, non-condensing.			-	
5	Vibration resistance	Occasional vibration			count 10 times each in X, Y and Z direction	IEC 61131-2
		Frequency	Acceleration	Amplitude		
		5 ≤ f < 9 Hz	-	3.5 mm		
		9 ≤ f ≤ 150 Hz	9.8 m/s ²	-		
		Continuous vibration				
		Frequency	Acceleration	Amplitude		
		5 ≤ f < 9 Hz	-	1.75 mm		
9 ≤ f ≤ 150 Hz	4.9 m/s ²	-				
6	Shock endurance	* Maximum shock acceleration: 147 m/s ² (15G) * Duration time: 11 ms * Pulse wave: half sine pulse (3 times each in X, Y and Z directions)			IEC 61131-2	
7	Noise Immunity	Square wave Impulse noise	AC: ±1,500V DC: ±1,000V		LS ELECTRIC Standard	
		Electrostatic discharge Immunity	±6 kV (Discharge by contact) ±8kV (Air discharge)		IEC 61131-2 IEC 61000-4-2	
		Radiated electromagnetic field noise	80 ~ 1000 MHz, 10 V/m		IEC 61131-2 IEC 61000-4-3	
		Fast transient & Burst noise	Category	Power module	Communication interface	IEC 61131-2 IEC 61000-4-4
Voltage	2 kV		1 kV			
8	Environment	Free from corrosive gases and excessive dust			-	
9	Operating height	Up to 2,000m (6,562 ft)			-	
10	Pollution degree	2 or less			-	
11	Cooling method	Self-cooling			-	

Remark

- (1) IEC(International Electro technical Commission)
: International private group facilitating international cooperation of electric/electronic standardization, issuing international standards and operating the compliance evaluation systems.
- (2) Pollution degree
: As an index representing the pollution degree of an environment to determine the insulation of a device, pollution degree 2 generally means the status generating non-conductive contamination. However, it also contains the status generating temporarily conduction due to condensation.

3.2 Function Standards

iXP Series function standard is as follows.

(1) DC type

Item	iXP50-TTA(B)/DC	iXP70-TTA(B)/DC	iXP80-TTA(B)/DC	iXP90-TTA(B)/DC
Display type	TFT LCD			
Screen size	21.3cm (8.4")	26.4cm (10.4")	30.7cm (12.1")	38.1cm (15")
Display Resolution	800 x 600 pixel (SVGA)	800 x 600 pixel (SVGA)	800 x 600 pixel (SVGA)	1,024 x 768 pixel (XGA)
Color indication	16-bit and 24-bit Color (default: 16-bit Color)			
Indication degree	Left/Right: 80 deg. Upper: 80 deg. Lower: 60 deg.	Left/Right: 80 deg. Upper: 60 deg. Lower: 80 deg.	Left/Right: 80 deg. Upper: 60 deg. Lower: 80 deg.	Left/Right: 80 deg. Upper: 60 deg. Lower: 80 deg.
Backlight	LED Type			
Backlight duration	70,000 hours	60,000 hours		
Brightness	500cd/m ²	700cd/m ²	550cd/m ²	800cd/m ²
Touch panel	4 – Line type, analog			
Sound Output	Magnetic buzzer (Max.85dB)			
Video Out	1 x RGB			
Audio Output	1 channel, stereo audio output			
Process	ARM Cortex-A8 Core (32bit RISC), 1GHz			
Memory	Flash	512MB(display 128MB)	1GB(display 128MB)	
	Operating RAM	256MB	512MB	
	Backup RAM	1MB		
Backup data	Date/Hour data, Logging/Alarm/Recipe data and nonvolatile device			
Battery duration	Approx. 3 years (Operating ambient temperature of 25°C)			
Ethernet	1 channel, IEEE802.1a, 10Base-T/100Base-TX			
USB Host	3 channels, USB 2.0 host (mouse, keyboard, printer and USB memory driver is available) 1 channel, USB 2.0 slave (for download and upload project file)			
RS-232C	1 channel			

Chapter 3. Standard Specification

Item	iXP50-TTA(B)/DC	iXP70-TTA(B)/DC	iXP80-TTA(B)/DC	iXP90-TTA(B)/DC
RS-422/485	1 channel,RS-422/485 mode			
SD Card	1 Slot (SDHC)			
Human sensor	-	Detection range: side 1-1.5m, front 40-50cm Angle: high/low 100°, left/right 140° (detecting 5-20 micron infrared light)		
Audio output	LINE-OUT 1 channel			
Expansion module	For communication and I/O option module (available later)			
VM module	-	4 channels video input (available later)		
Multi-language	Up to 8 language simultaneously			
Animation	GIF format is available			
Recipe	available			
Data logging	available			
Script executor	available			
Certifications	CE, UL(cUL), KC			
Protection standard	IP65, (IEC 60079-0 6 th , IEC 60079-15, 4 th , and IEC 60079-31, 2 nd TTB Model Only)			
Dimension (mm)	240.5 x 180.0 x 54.4	270.5 x 212.5 x 60.0	313.0 x 239.0 x 56.0	395.0 x 294.0 x 60.0
Panel cut (mm)	228.5 x 158.5	259.0 x 201.0	301.5 x 227.5	383.5 x 282.5
Rated voltage	DC24V	DC12/24V		
Power consumption (W)	36	42	42	42
Weight(Kg)	1.9	2.2	2.4	3.9

Note

- (1) Caution in power connection
: With DC power applied to AC power device, it may cause product damage or fire.
Please pay a special attention to connection.
- (2) FG Connection
: For the device FG, please use ⑤ FG terminal in the Chapter 2.1, which is FG terminal for extended FG card.
- (3) Battery discharge-preventing tape and DIP switch
: Tape is attached to prevent battery discharge. To use backup function, please remove the tape and turn on DIP switch No. 3.
- (4) Battery Operation and Life
: Battery is used for backup data maintenance and RTC (date/time) when the power of device is off. It is used only when power is Off. Battery is not consumed with power applied. If battery is discharged, Super-Cap is used for 8 days for backup data maintenance and RTC (date/time) with power off
- (5) LCD Backlight Replacement
: Please replace LCD if you want to replace LCD backlight.
- (6) Caution in Audio Output
: Unamplified speaker without the volume adjustment function such as earphone, headset, etc. may make a small sound output through LINE-OUT.
- (7) Protection Standard
: Protection Standard of XGT Panel is designed to suit for IP65 condition under the IEC60529(Degrees of protection provided by enclosures).
Although the front of XGT Panel that is installed on the panel suits for Protection Standard, it does not guarantee about all circumstances of installation. Please refer to Chapter 10. Installation and Wiring about installation.

(8) USB memory file system standard

: USB memory has to format as FAT or FAT32.

(9) The following special conditions need to be listed (TTB Model Only)

: The equipment presents a potential electrostatic hazard. Clean only with a damp cloth

The device shall be installed in an enclosure that maintains an ingress protection rating of at least IP54 and meets the enclosure requirements of IEC 60079-0 and IEC 60079-15.

Must be installed in accordance with EN 60079-14

Do not connect or separate plugs and sockets while an explosive atmosphere is present.

Keep out of direct sunlight.

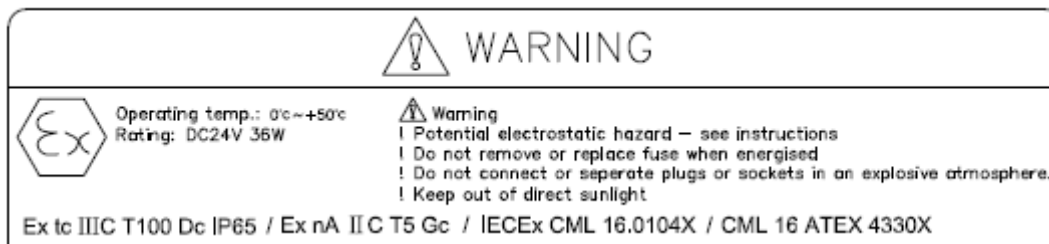

Chapter 3. Standard Specification

(2) AC type

Item	iXP70-TTA/AC	iXP80-TTA/AC	iXP90-TTA/AC
Display type	TFT LCD		
Screen size	26.4cm (10.4")	30.7cm (12.1")	38.1cm (15")
Display Resolution	800 x 600 pixel (SVGA)	800 x 600 pixel (SVGA)	1,024 x 768 pixel (XGA)
Color indication	16-bit and 24-bit Color (default: 16-bit Color)		
Indication degree	Left/Right: 80 deg. Upper: 60 deg. Lower: 80 deg.	Left/Right: 80 deg. Upper: 60 deg. Lower: 80 deg.	Left/Right: 80 deg. Upper: 60 deg. Lower: 80 deg.
Backlight	LED Type (replaceable)		
Backlight duration	60,000 hours		
Brightness	700cd/m ²	550cd/m ²	800cd/m ²
Touch panel	4 – Line type, analog		
Sound Output	Magnetic buzzer (Max.85dB)		
Video Out	1 x RGB		
Audio Output	1 channel, stereo audio output		
Process	ARM Cortex-A8 Core (32bit RISC), 1GHz		
Memory	Flash	1GB(display 128MB)	
	Operating RAM	512MB	
	Backup RAM	1MB	
Backup data	Date/Hour data, Logging/Alarm/Recipe data and nonvolatile device		
Battery duration	Approx. 3 years (Operating ambient temperature of 25°C)		
Ethernet	1 channel, IEEE802.1a, 10Base-T/100Base-TX		
USB Host	3 channels, USB 2.0 host (mouse, keyboard, printer and USB memory driver is available) 1 channel, USB 2.0 slave (for download and upload project file)		
RS-232C	1 channel		
RS-422/485	1 channel,RS-422/485 mode		
SD Card	1 Slot (SDHC)		
Human sensor	Detection range: side 1-1.5m, front 40-50cm Angle: high/low 100°, left/right 140° (detecting 5-20 micron infrared light)		
Audio output	LINE-OUT 1 channel		
Expansion module	For communication and I/O option module (available later)		
VM module	4 channels video input (available later)		
Multi-language	Up to 8 language simultaneously		
Animation	GIF format is available		
Recipe	available		
Data logging	available		
Script executor	available		
Certifications	CE, UL(cUL), KC		

Item	iXP70-TTA/AC	iXP80-TTA/AC	iXP90-TTA/AC
Protection standard	IP65		
Dimension (mm)	270.5 x 212.5 x 60.0	313.0 x 239.0 x 56.0	395.0 x 294.0 x 60.0
Panel cut (mm)	259.0 x 201.0	301.5 x 227.5	383.5 x 282.5
Rated voltage	AC 100-240V		
Power consumption (W)	42	42	42
Weight(Kg)	2.2	2.4	3.9

Note

- (1) Caution in power connection
: With AC power applied to DC power device, it may cause product damage or fire.
Please pay a special attention to connection.
- (2) FG Connection
: For the device FG, please use ⑤ FG terminal in the Chapter 2.1, which is FG terminal for extended FG card.
- (3) Battery discharge-preventing tape and DIP switch
: Tape is attached to prevent battery discharge. To use backup function, please remove the tape and turn on DIP switch No. 3.
- (4) Battery Operation and Life
: Battery is used for backup data maintenance and RTC (date/time) when the power of device is off. It is used only when power is Off. Battery is not consumed with power applied. If battery is discharged, Super-Cap is used for 8 days for backup data maintenance and RTC (date/time) with power off
- (5) LCD Backlight Replacement
: Please replace LCD if you want to replace LCD backlight.
- (6) Caution in Audio Output
: Unamplified speaker without the volume adjustment function such as earphone, headset, etc. may make a small sound output through LINE-OUT.
- (7) Protection Standard
: Protection Standard of XGT Panel is designed to suit for IP65 condition under the IEC60529(Degrees of protection provided by enclosures).
Although the front of XGT Panel that is installed on the panel suits for Protection Standard, it does not guarantee about all circumstances of installation. Please refer to Chapter 10. Installation and Wiring about installation.
- (8) USB memory file system standard
: USB memory has to format as FAT or FAT32.

Chapter 4. System Configuration

It describes the system configuration including XGT Panel's time setting, Ethernet connection setting, and connection with PC and backlight.

If you press [Settings] button in XGT Panel's basic screen, you can set XGT Panel's environment as follows.

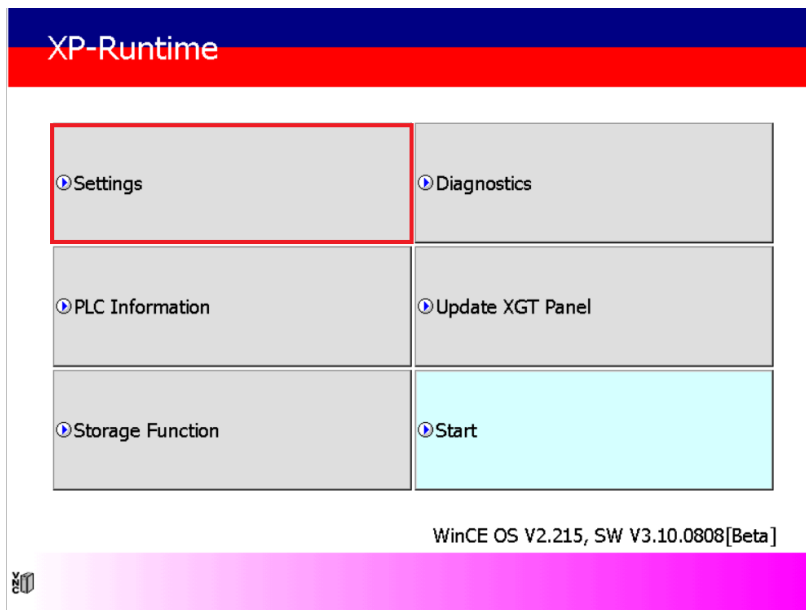

[Main screen]

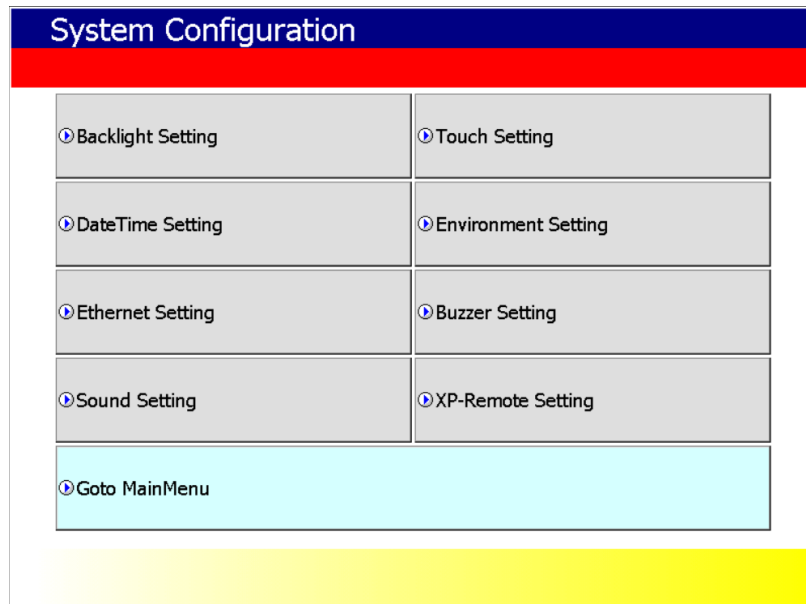

[System Configuration screen]

4.1 Backlight Setting

If you press [Backlight Setting] button in [System Configuration] screen as follows, setting screen shows up.

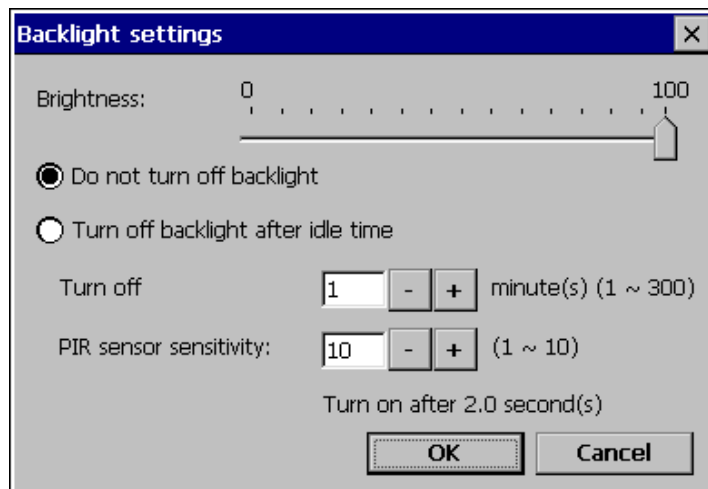
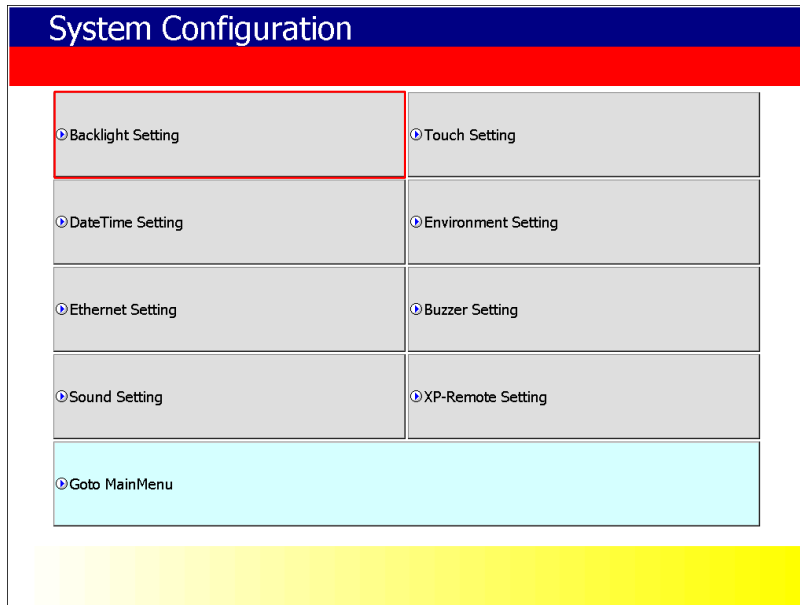

[Dialog box explanation]

Name	Explanation
Brightness	It may adjust brightness of backlight.
Do not turn off backlight	It doesn't turn off backlight power.
Turn off backlight after idle time	It automatically turns off backlight if not in touch for a certain period of time.
Turn off ~ minutes	It turns off backlight after a designated time (unit of minute).
PIR sensor sensitivity	Set the sensitivity level for the PIR (Passive Infrared) sensor. The lower the value, the quicker the backlight will turn on. When set to the lowest value, the backlight will turn on immediately when the screen is touched.

4.2 Touch Calibration

When the location 5 is not recognized in XGT Panel, Touch's scale can be adjusted in XGT Panel. If you press [Touch Calibration] button in System Configuration, the setting screen shows up. If you press five '+' marks, XGT Panel's touch location adjustment is completed.

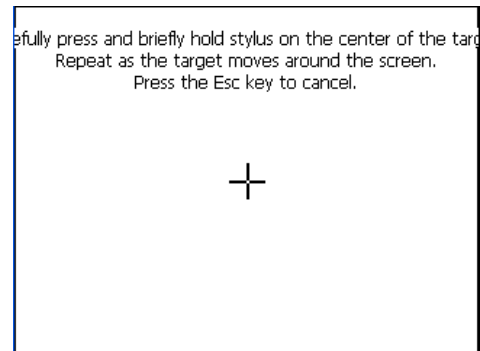
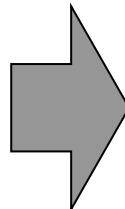
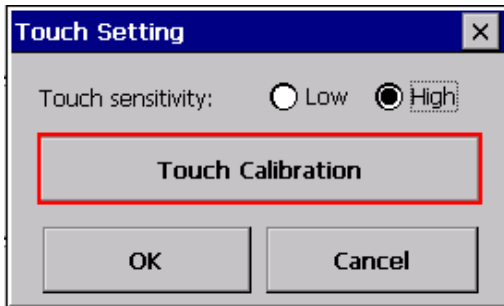
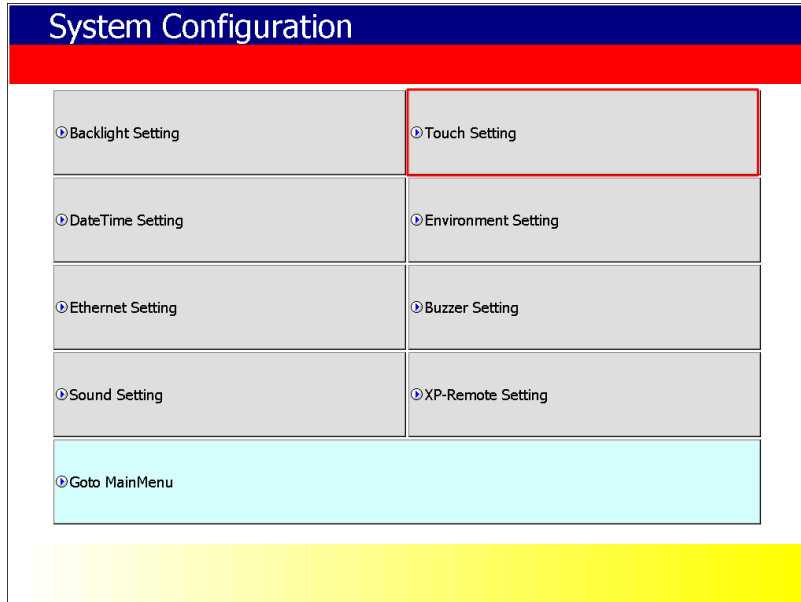

It is possible to change the option of [Touch Sensitivity] Low or High. The high option is more sensitive than Low. But if you choose more than two points, it will cause the equipment malfunction.

Remark

- (1) XGT Panel's Touch Calibration setting is basically set. If Touch location is way off, adjusting menu with touch can be hard through touch. In that case, You can select the Touch Calibration setting menu by USB mouse or simply touch 5 times at the empty space on the main screen.
- (2) When touch location changes in using, redo touch setting.
- (3) If you don't allow Multi-touch, sensitivity is lower than when allowing Multi-touch.

4.2.1 PIR sensor

The XGT Panel's backlight is activated by detecting movement around the XGT Panel. If you approach the XGT Panel when the display is off, movement around the XGT Panel from the left, right or front, is detected and turns on the backlight.

- (1) The XGT Panel has a detection range of 1-1.5m from both sides.



- (2) The XGT Panel has a detection range of 40-50cm from the front.



Remark

The detection distance may vary depending on temperature and location.

4.3 Date Time Setting

If you press [Date Time Setting] button in [System Configuration] as follows, you can set XGT Panel's data and time.

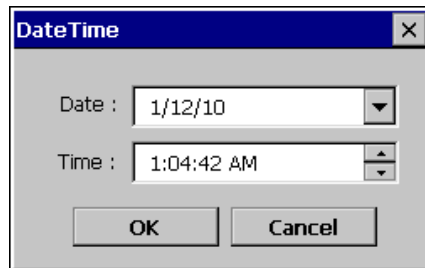
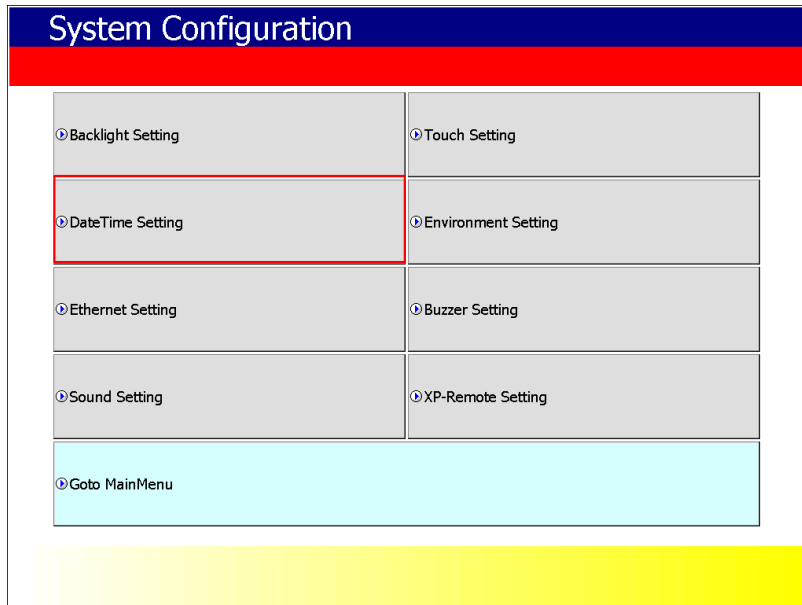

Remark

You can set data/time at device information of communication dialog at the XP-Builder.
For details, please refer to the XP-Builder's manual.

4.4 Environment Setting

If you press [Environment Setting] button in [System Configuration] screen as follows, you can set 'Auto Goto Screen' and 'Buzzer On/Off'.

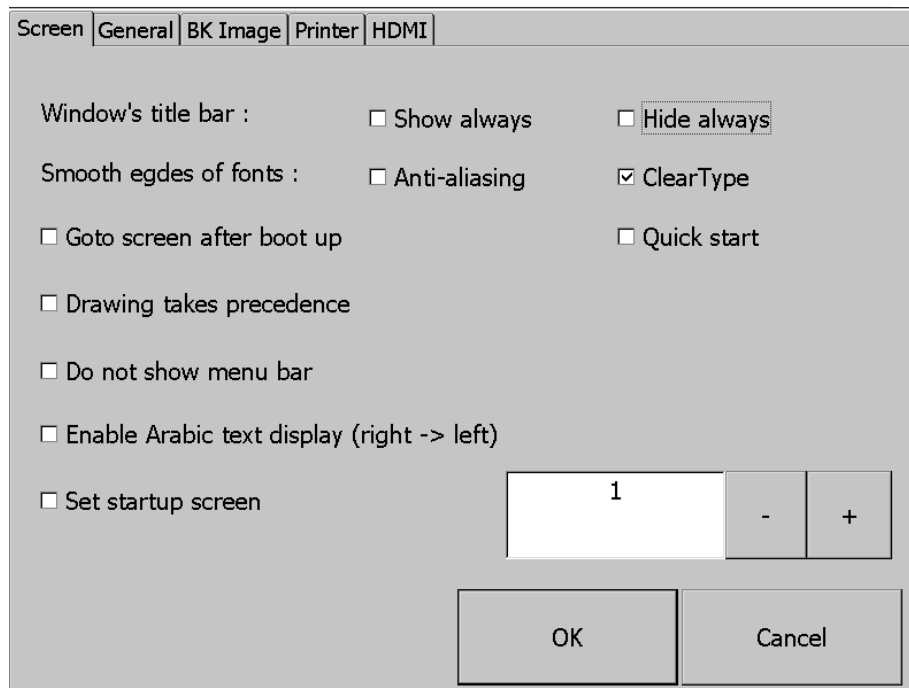
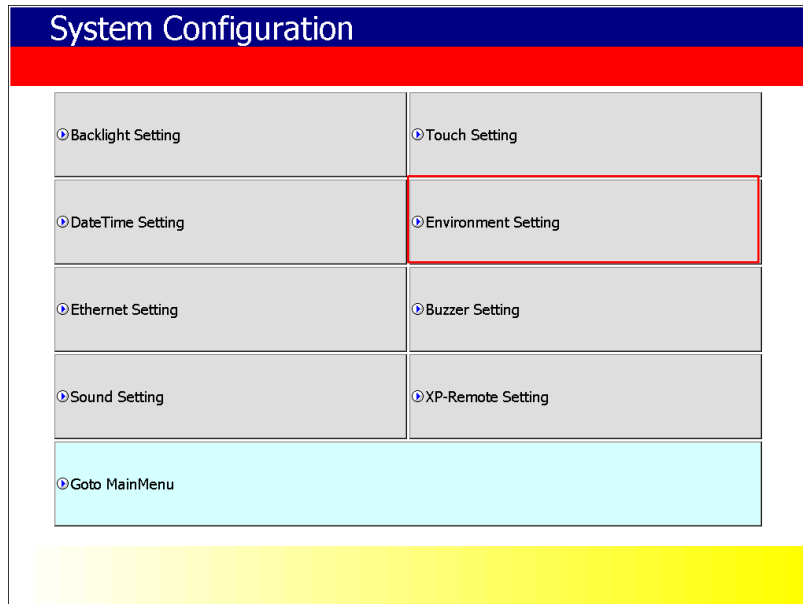

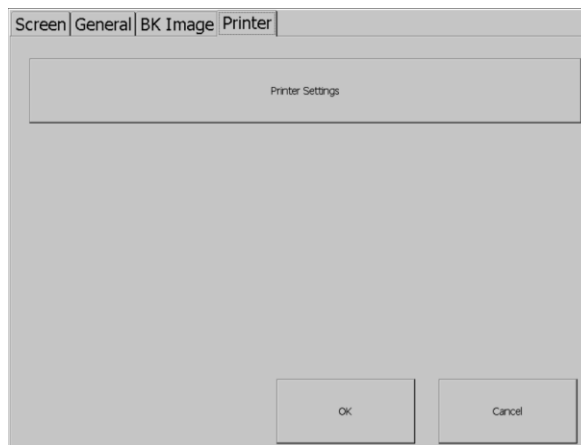
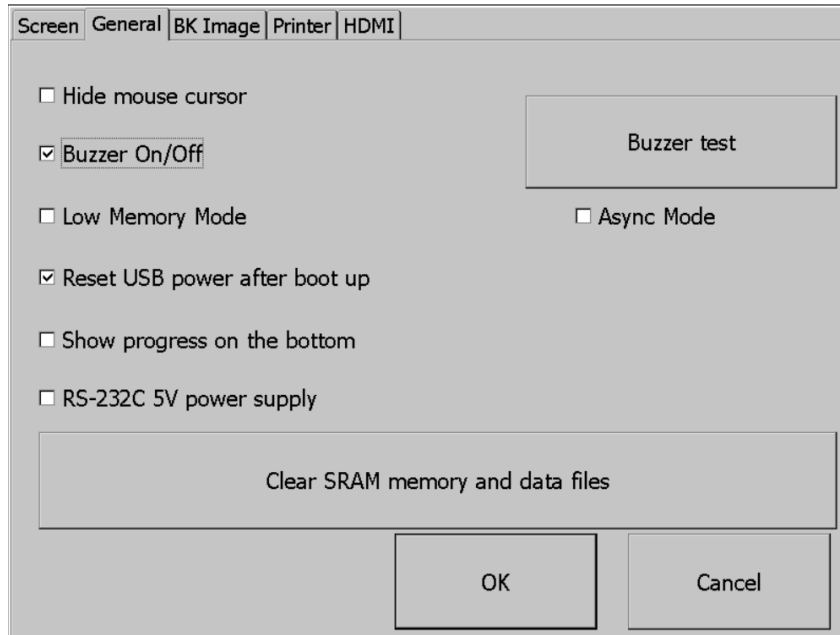

Name	Explanation
Window's title bar : Show always /Hide always	<p>If you select [Show always], the title bar displays when a pop-up window is displayed on the screen. You can select and move the title bar of the pop-up window. If you select [Hide always] the title bar will not be displayed when a pop-up window is displayed on the screen, and you will not see it when you click the window screen blank.</p> <p>If you uncheck [Show always], [Hide always], the title bar will not be displayed when the pop-up window is displayed on the screen, and the title bar will appear when you click the window screen blank.</p>
Smooth edges of fonts : Anti-aliasing/ ClearType	<p>Smoothly handle the edge of each stroke when the letter is displayed. To do this, you can choose between Anti-aliasing and ClearType. Generally, applying ClearType is more poetic, but Anti-aliasing may be better, depending on the font type and font size. Smooth font display by selecting one of the two increases the load on the system, especially as the font size increases, it may have a performance impact on functions such as flow alarms.</p> <p>This feature is available on iXP, iXP2 and later models</p>
Goto screen after boot up	<p>When setting [Auto Goto Screen], XGT Panel is rebooted. Or when downloading the edit data is completed, the screen automatically shows up. If you cancel this setting, the user should press 'Start' button in order to move to the screen.</p>
Quick Start	<p>When starting screen, screen shows promptly without showing progress bar because it doesn't caching the image in advance. However, if you select this option, first screen shows slowly. Especially, if there are many animation objects in screen, it may take several seconds based on image. But fast screen switching is available since second screen switching.</p>
Drawing takes precedence	<p>If you choose [Drawing takes precedence], the screen that you have already entered when switching the screen will display the image/value based on the data that was last displayed at that time. Then read the actual device value and display the image/value again. If the screen is entering for the first time, it will behave the same as when [Drawing takes precedence] is deselected.</p> <p>If you deselect [Drawing takes precedence] when switching the screen, read the actual device value and display the image/value. This may take some time to switch screens depending on the network situation or PLC response rate.</p>
Do not show menu bar	<p>In order to exit to the standby screen during screen monitoring, The window (menu bar) does not appear. If this is the case, You need to configure and use a special switch to exit the screen.</p>
Enable Arabic text Display (right-> left)	<p>Enables the right-to-left language.</p>
Set startup screen	<p>The screen corresponding to the number entered at the start of monitoring is displayed.</p>
Hide Mouse Cursor	<p>Mouse cursor doesn't show after screen switching</p>
Buzzer On/Off	<p>You can set whether you use buzzer through [Buzzer On/Off] button.</p>
Buzzer Test	<p>It may test the buzzer.</p>

Name	Explanation
Low Memory Mode	<p>XGT Panel starts monitoring the images used on the screen to speed up the screen operation.</p> <p>It will be loaded into memory before use. By the way,</p> <p>If a positive image is used, due to memory space constraints, all</p> <p>The image will not load. In this case, if the screen is not yet loaded</p> <p>Images are loaded, and there is not enough space, so unused images are retrieved from memory</p> <p>The operation to delete may be repeated, and the screen switching operation may be slowed down. In this situation</p> <p>Low Memory Mode "is recommended. In Low Memory Mode, you do not load the image before monitoring, but use only the original source of the image used in the project, which results in less memory usage and less load to load and delete images into memory.</p>
Async mode	<p>Ensures the order of operation when entering values by bit switch, word switch, multi-switch, etc. when [Async mode] is deselected. In other words, when 1, 2, 3 actions are performed by multiple switches or overlapped switches, 2 is performed when 1 action is completed, and 3 is performed only when 2 is completed. Therefore, if there is no response from the target controller in Operation 1, the actions 2 and 3 are also delayed even if the controller is different.</p> <p>When [Async mode] is selected, the value is entered by bit switch, word switch, multi-switch, etc. without ensuring order. In other words, when 1, 2, 3 actions are performed by multiple switches or overlaid switches, each action can be completed in the order of 2, 1 and 3 depending on the network situation or controller response speed. Although the order is not followed, it has the advantage of operating quickly for the rest of the controllers even if some of them do not respond.</p>
Reset USB power after boot up	<p>When XGT Panel starts, USB power state is converted from Off to On initializing the connected device.</p>
Show progress on the bottom	<p>It indicates title bar on pop up window. With title bar of pop up window selected, it may move the location.</p>
RS-232C 5V Power Supply	<p>When the monitor starts with XGT Panel button [Start] pushed, it outputs 5V power using No. 9 pin of RS-232C Port. When turning off XGT Panel monitor and returning to menu screen again, it stops power output.</p>
Clear SRAM memory and data files	<p>All files downloaded by the user are deleted. If connection password is set, you have to input the password. This password is connection password needed for project download, etc. You can set that password in [Communication] → [XGT Panel Information] → [Password] tap. The deleted files are user project file, web server, VNC start module, option card driver, RAPIEnet communication setting data, XP-manager setting data and etc. Setting through Environment Setting menu of device is not initialized.</p>

Name	Explanation
Set Background Image	<p>If you select the image through [Set Background Image], background image of waiting screen is set as the selected image. If you want to cancel, press [Delete Background Image]</p> <div data-bbox="632 454 1283 891" style="border: 1px solid black; padding: 5px; margin: 10px auto; width: fit-content;"> <p>Select Folder</p> <p>Select Source <input checked="" type="radio"/> USB <input type="radio"/> SD</p> <p>\USB Storage\ BKIMAGE.BMP</p> <p><input type="checkbox"/> Use boot image OK Cancel</p> </div> <p style="text-align: center;">[Background Image Selection Screen]</p> <p>[Use boot image] With an option selected, you cannot use it unless it is the image of different resolution from that of XGT Panel or 32-bit image.</p>
Delete background image	<p>When you select an image, the XGT Panel is powered on and the standby screen and desktop are selected.</p> <p>Set to image. To turn off background settings, click the Clear Background button. Just press it.</p> <p>If you select the Use boot image option, you cannot use it unless it is an image with a resolution different from the XGT Panel or a 24bit BMP image.</p>

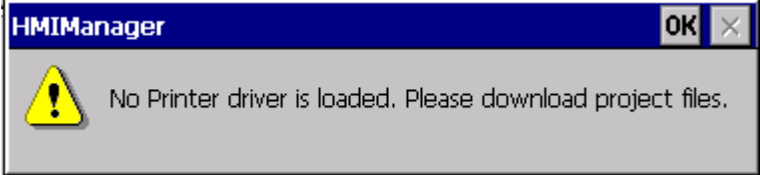
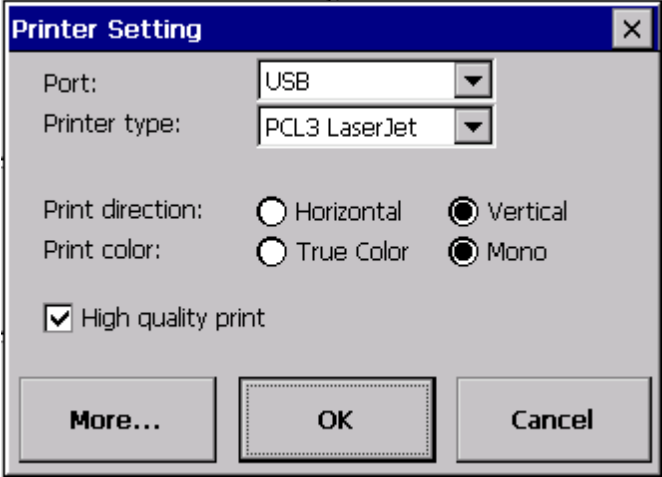
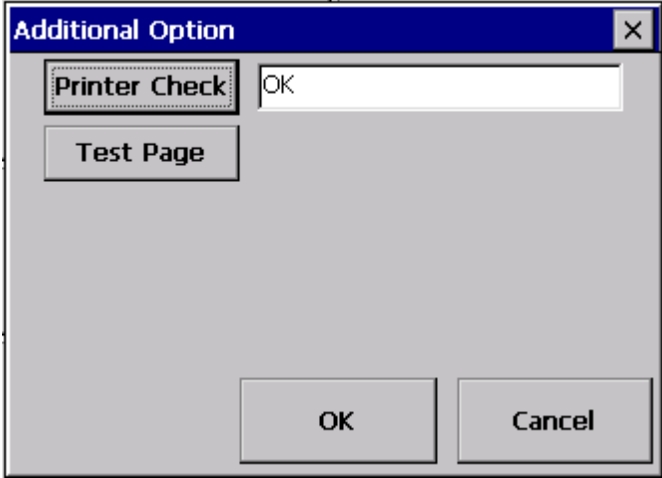
Name	Explanation
Printer Settings	<p>If there are no information of printer, the pop-up will be shown. If the pop-up is shown, you need to set up the printer to use XP-Builder</p>  <p><No printer drivers and information → Need to download ></p>   <p><Printer drivers and information available ></p>

Name	Explanation	
Printer Settings	Name	Explanation
	Port	Set up the printer port.
	Printer type	Set up the printer type.
	Print direction	Set up the print direction - width or height
	Print color	Set up the print color - color or mono
	High quality print	Set up the printer quality
	More...	Show additional properties
	OK	Save the set-up information
	Cancel	Cancel the set-up information
	Printer Check	Diagnose the connection status: This function only applies to those printers as LK-P30, LK-P41, LK-P43 *Message* 1. OK 2. No Printer 3. Cover Open 4. Paper Empty
	Test Page	Print test page. ***** Test page ***** Date Time: 2014-02-04 10:00:00 XP-Runtime version: 1320 Printer driver version: 1.00 Printer name: PCL3 LaserJet Port: USB *****

Note
 Buzzer can make settings in information on device tab of communication dialog box in the XP-Builder.
 Please refer to the XP-Builder's manual.

4.5 Ethernet Setting

If you press [Ethernet Setting] button in [System Configuration] screen as follows, you can change IP to use Ethernet.

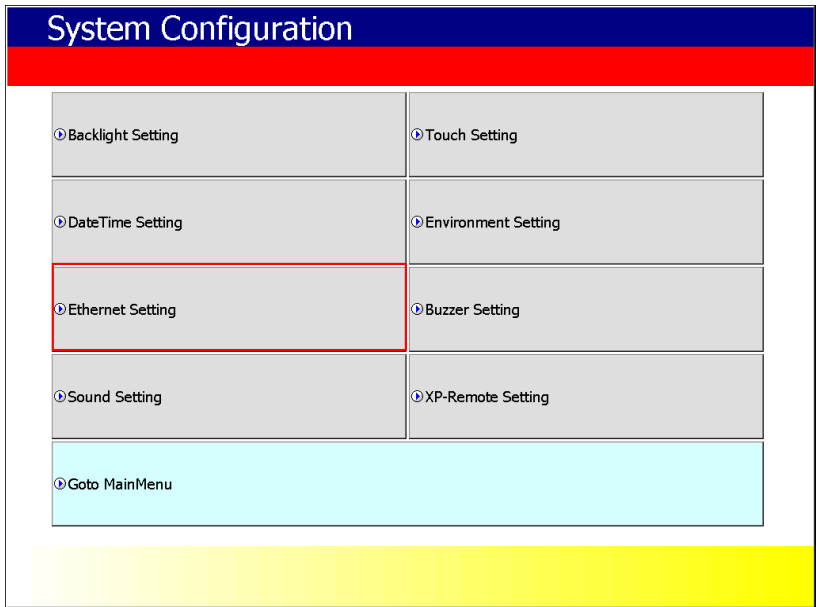

You can change IP address by pressing [Set] button of each IP address, Subnet Mask and Gateway. By pressing OK button, changed IP information is reserved.

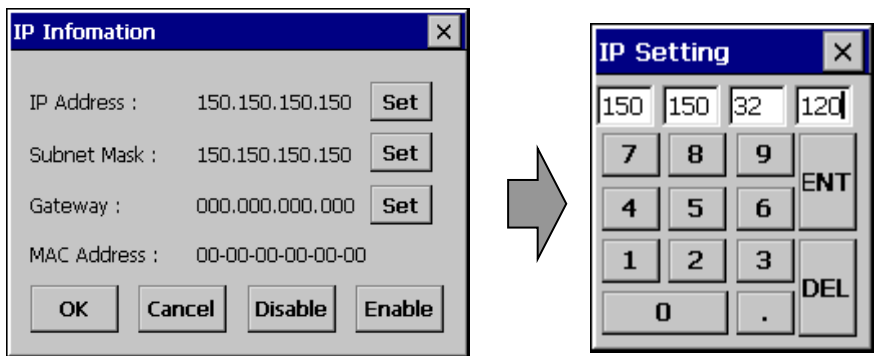

Remark

We recommend the following method, when connecting with PC solely.

- | | |
|--|---|
| <p>1) XGT Panel setting</p> <ul style="list-style-type: none"> - IP Address : 192.168.0.10 - Subnet Mask: 255.255.255.0 - Gateway : 192.168.0.1 | <p>2) PC setting</p> <ul style="list-style-type: none"> - IP Address : 192.168.0.11 - Subnet Mask: 255.255.255.0 - Gateway : 192.168.0.1 |
|--|---|

If you reboot after pressing [Disable] button, the device will not use Ethernet. In this case, booting speed gets faster. If you use Ethernet again, reboot after pressing [Enable].

4.6 Buzzer Setting

It may adjust volume and height of XGT Panel Buzzer.

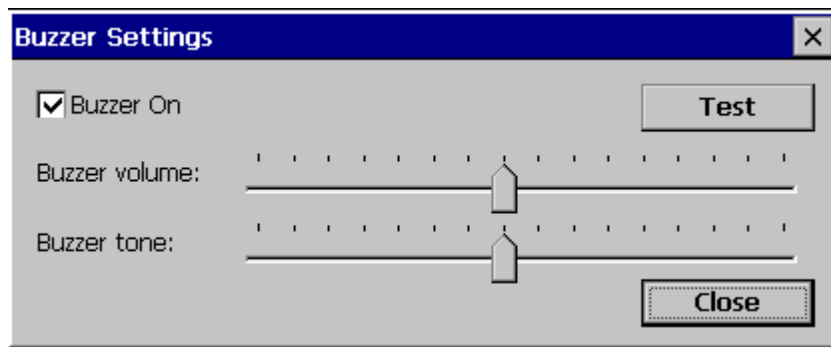
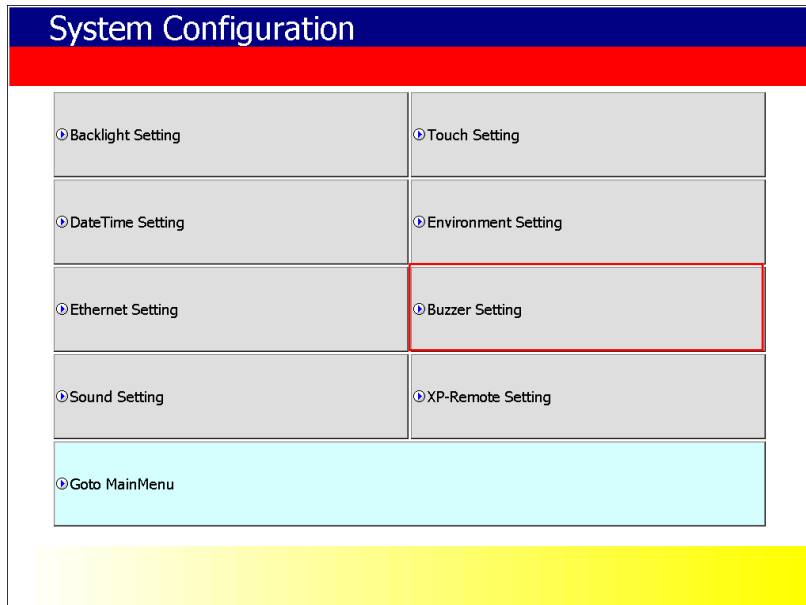

[Buzzer Settings Screen]

[Explanation of dialog box]

Name	Explanation
Buzzer On/Off	It may turn on or off the buzzer that occurs when in touch mode
Buzzer volume	It may adjust the volume of Buzzer
Buzzer tone	It may adjust the height of Buzzer.

4.7 Sound Setting

It may adjust XGT Panel sound volume.

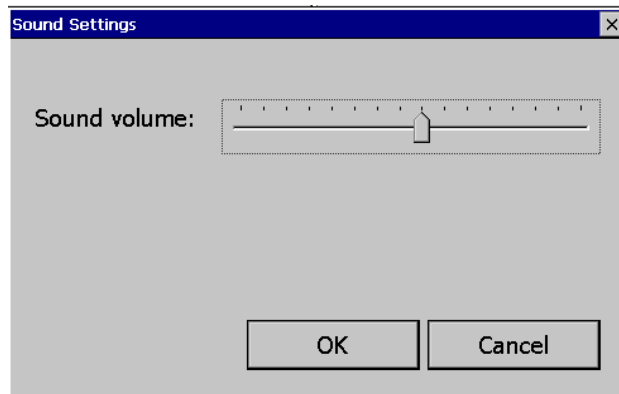
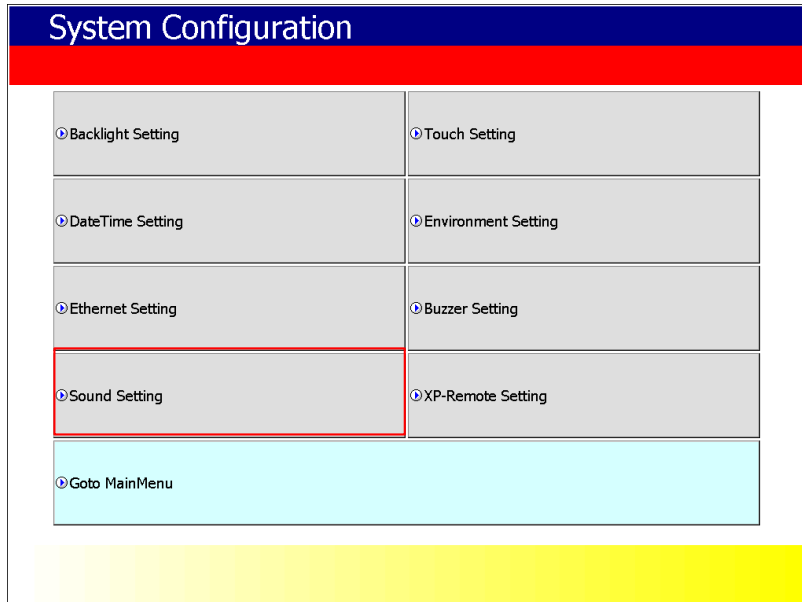

[Sound Setting Screen]

[Dialog box Explanation]

Name	Explanation
Sound volume	It may adjust sound output volume.

Note

In case of microphone with power not applied like ear microphone, it has no sound input function.
 Unamplified speaker without volume adjustment function such as earphone, headset, etc. may make a small sound output through LINE-OUT

4.8 XP-Remote Setting

Settings of XP-Remote that can remotely adjust XGT Panel can be changed.

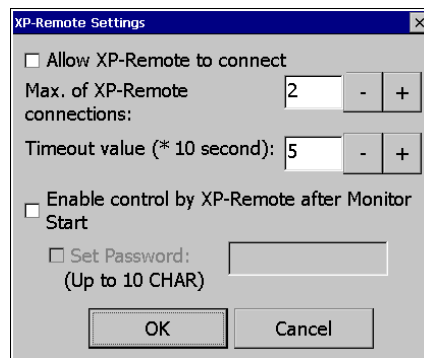
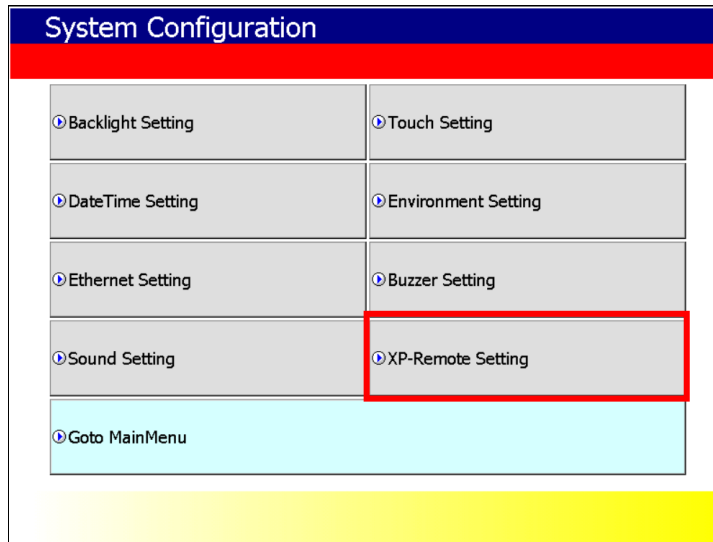

[XP-Remote Setting Screen]

[Explanation of dialog box]

Name	Explanation
Allow XP-Remote to connect	It allows connecting remote XP-Remote.
Max. of XP-Remote connections	It designates the maximum number of XP-Remote connected with XGT Panel.
Timeout value	It stops communication when there is no request of communication from XP-Remote within the designated time. In case XP-Remote is entitled to manipulation, it withdraws the right to manipulation (10 seconds ~ 300 seconds)
Enable control by XP-Remote after monitor start	The XGT Panel will automatically be in the Operation Permit state after the monitor
Set Password	You can set it to enter a password when you request a connection from XP-Remote. If a password is set here, remote monitoring will only begin if the UI enters the password when connecting to XP-Remote.

Note

For the function of XP-Remote in detail, please refer to XP-Remote user's manual.

Chapter 5. Diagnostics

It describes the diagnosis function for XGT Panel's communication terminal, screen and touch function. If you press [Diagnostics] button on the XGT Panel's basic screen, the menu for diagnosis shows up.

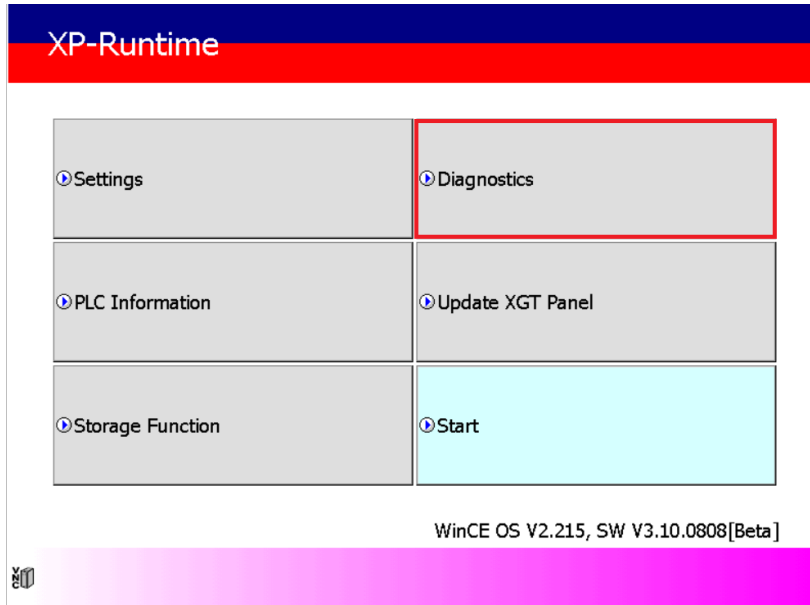

[Main Screen]

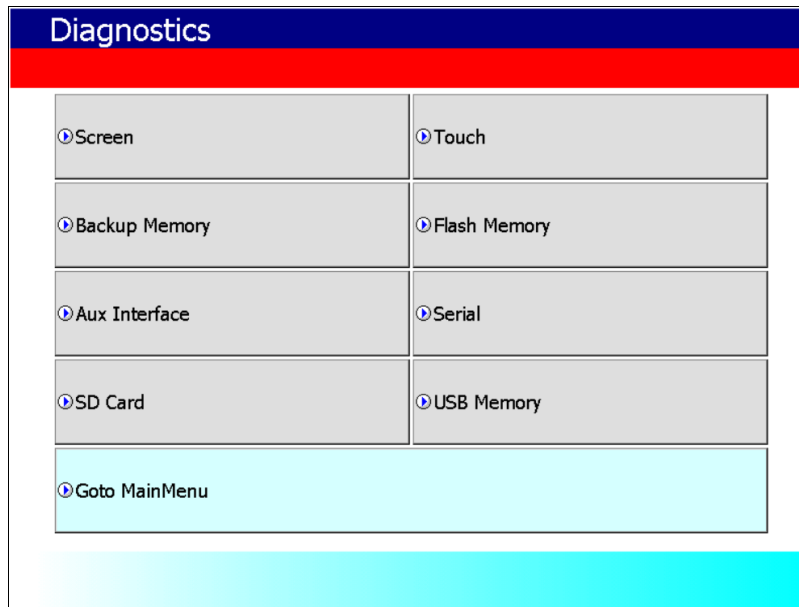

[Environment setting screen]

5.1 Screen Diagnosis

If you press [Screen] button, screens continuously change into diverse color with buzzer. For XP30-BTA/DC product, screen changes into 8 steps' light. After all screen for diagnosis pass. Then, Close button shows up with white ground. If you press Close button, the initial screen shows up.

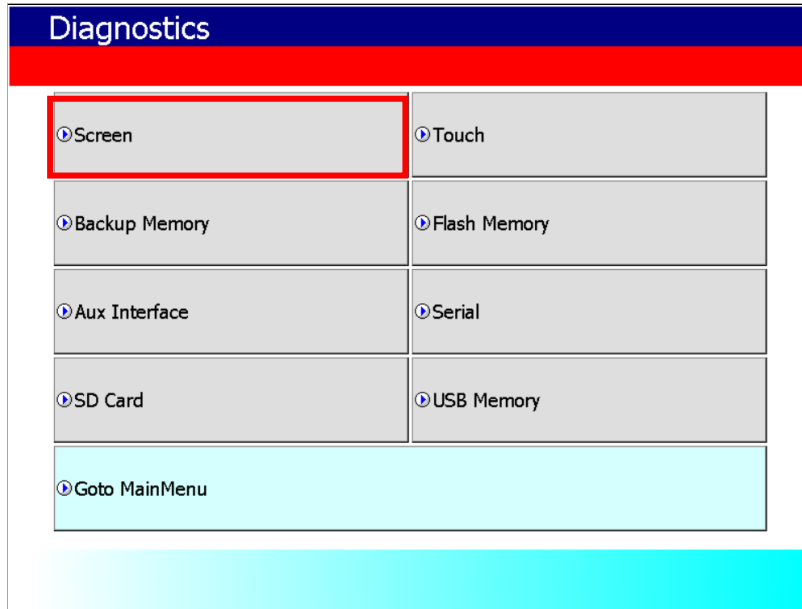

[Diagnosis screen]



[Screen diagnosis]

Display Sequence	RED > GREEN > BLUE > BLACK > WHITE>GRAPH
-------------------------	--

5.2 Touch Diagnosis

If you touch the screen, the touched location is displayed as follows. If pressing the [OK] button, you can quit the screen.

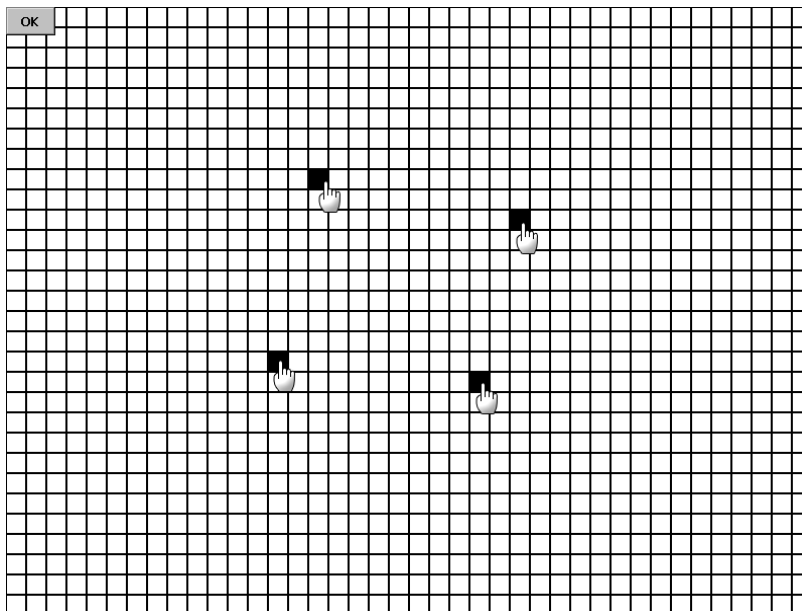
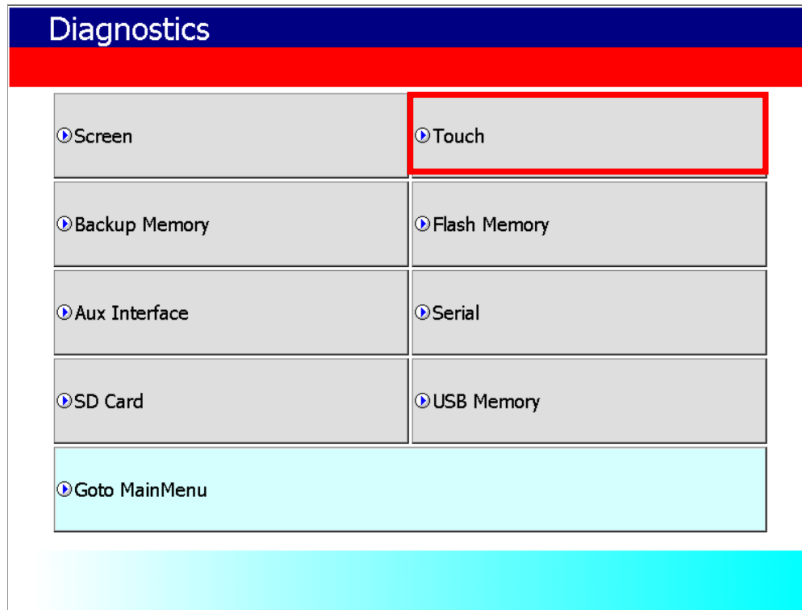

[Touch diagnosis]

If the touched location is not correct, reset the Touch setting. For detailed information, please refer to the Chapter 4. System Configuration.

5.3 Backup Memory Diagnosis

If you press [Backup Memory] button, you can see the result of diagnosis in the result windows.

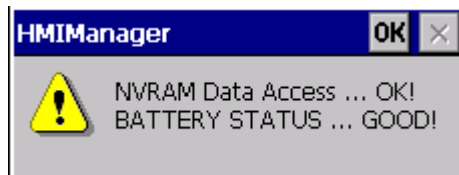
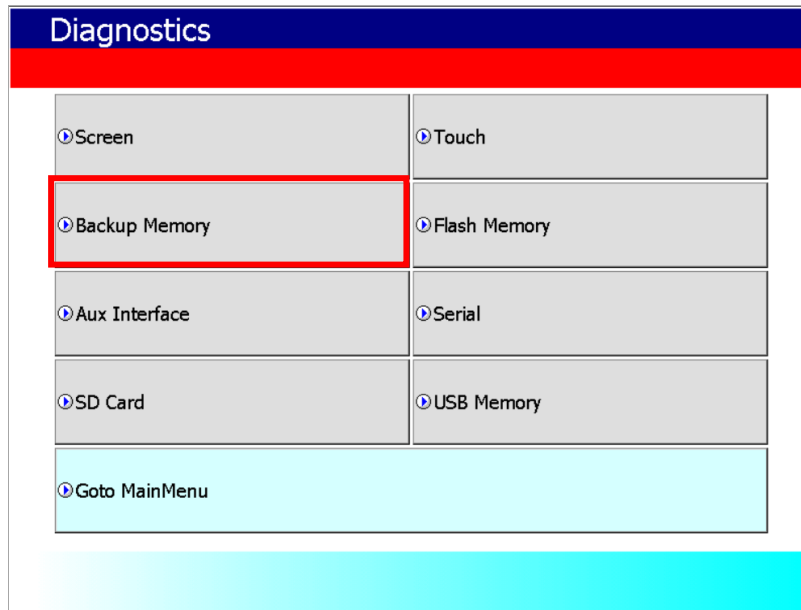

Completion of Backup Memory diagnosis

Remark

- (1) If 'NVRAM Data Access ... Fail' error is occurred, please contact with customer service center.
- (2) If 'BATTERY STATUS ... BAD' error is occurred, battery should be changed. Please contact with Customer service center.

5.4 Flash Memory Diagnosis Function

If you press [NOR Flash] button, you can see the result of diagnosis in the result widows.

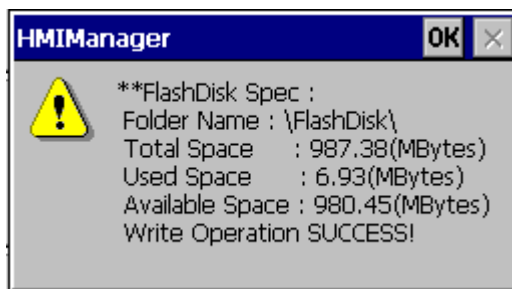
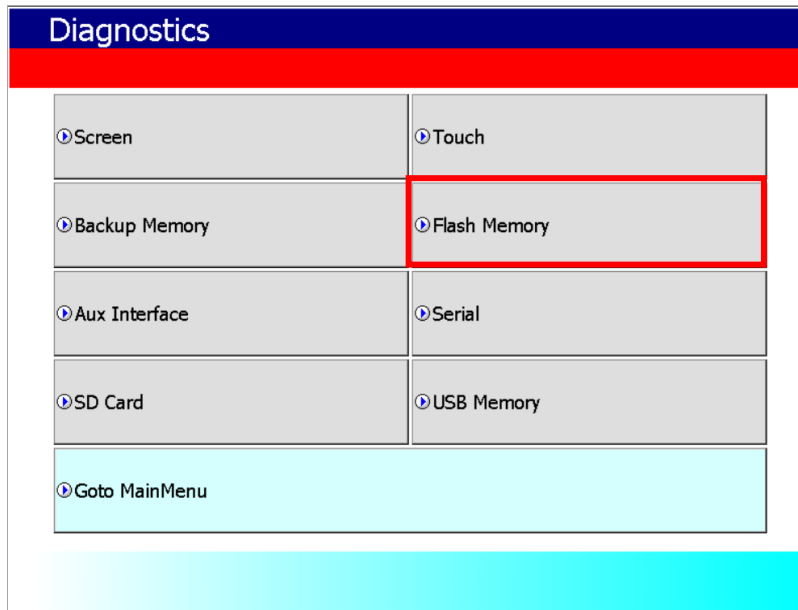

Remark

If 'Read Disk Information Error!' occurs, please contact with Customer service center.

5.5 Serial Communication Diagnosis

If you press [Serial] button, you can diagnose Serial ports which is equipped at XGT Panel.
(In case of diagnosis purpose, you have to connect the loop-back terminal at each port.)

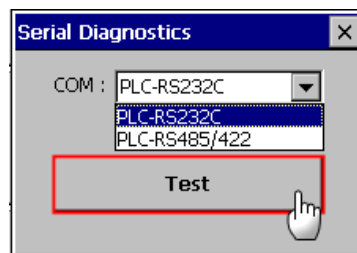
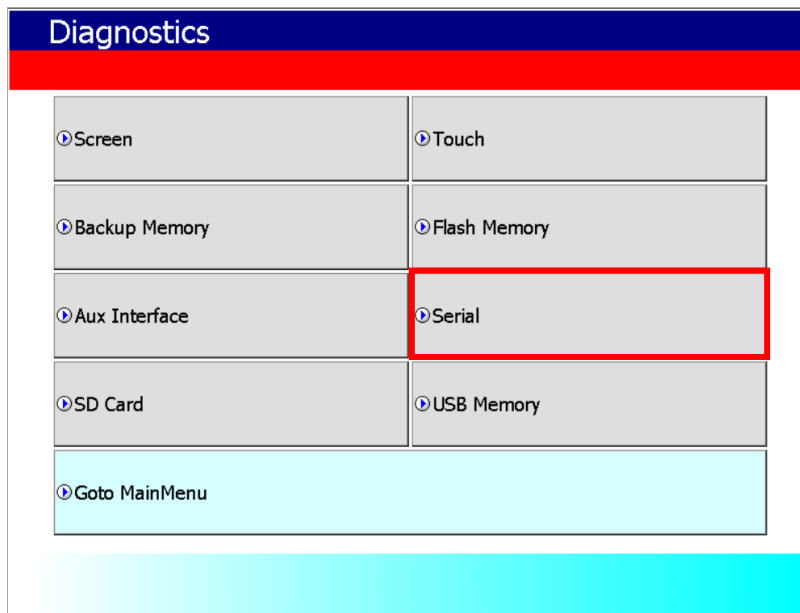

Serial port selection

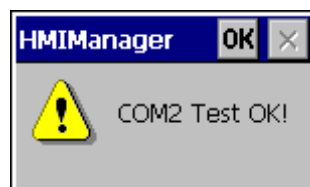

Completion of serial port diagnosis

Ch.6 Viewing Information of PLC Connection Status

The RS-232C port terminal should be made as follows

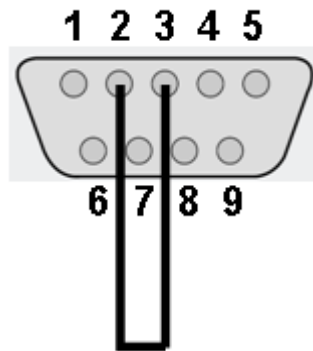

(Connect the No.2 and 3 pin)

The RS-422/485 port terminal should be made as follows.

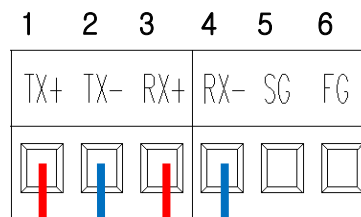

(Connect the TX+ with RX+ and TX- with RX-)

Pin	Name	Function
1	TX+	Transferring data
2	TX-	Transferring data
3	RX+	Receiving data
4	RX-	Receiving data
5	SG	Signal Ground
6	FG	Frame Ground

5.6 SD Card Diagnosis

If you press [SD Card] button, the result of diagnosis shows up in the result windows.

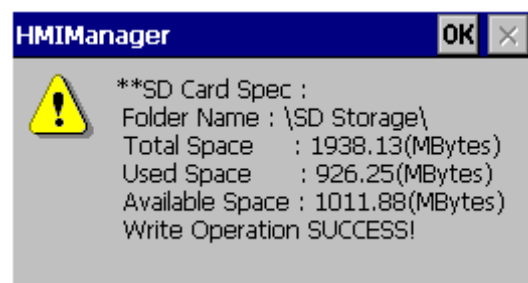
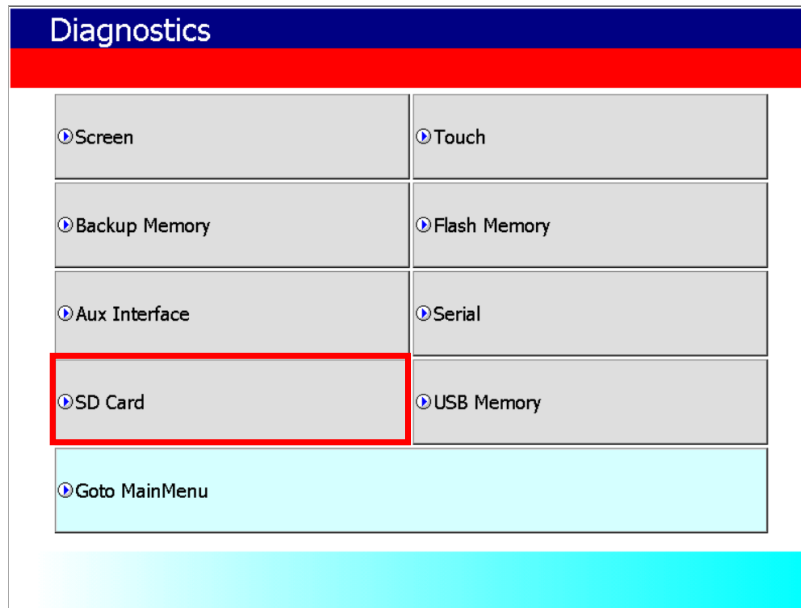

Completion of SD Card diagnosis

Remark

If 'Read Disk Information Error!' occurs, please contact with Customer service center.

5.7 USB Memory Diagnosis

If you press [USB Memory] button, the result of diagnosis shows up in the result windows.

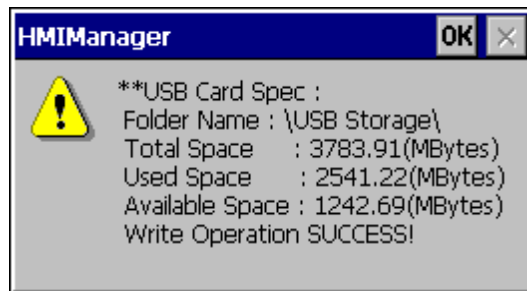
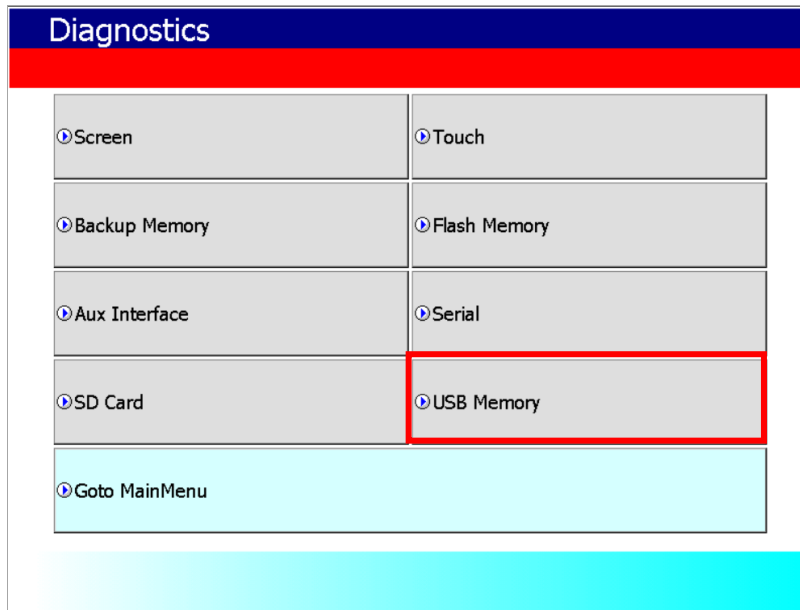

Completion of USB Memory diagnosis

Remark

If 'Read Disk Information Error!' occurs, please contact with Customer service center.

Chapter 6 Viewing Information of PLC Connection Status

PLC Information, it shows XGT Panel configuration, PLC CPU status and various records.

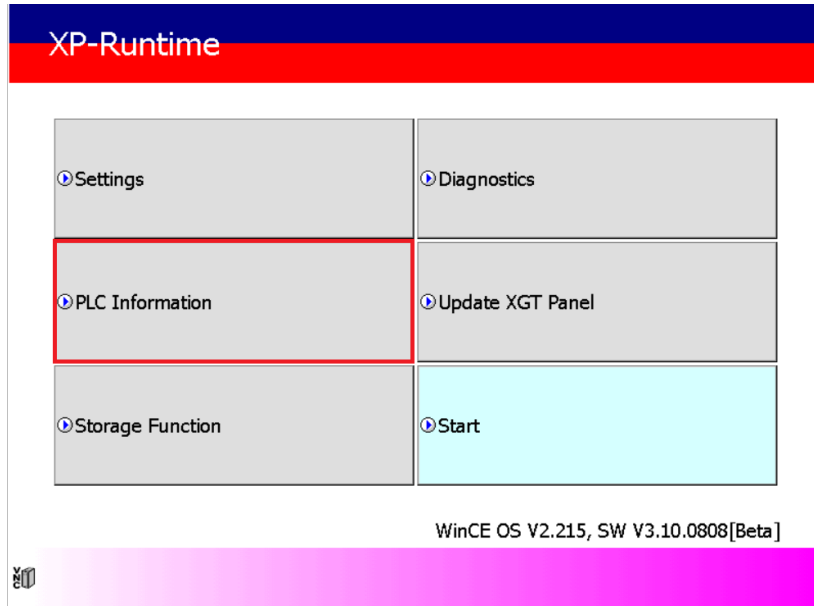

Remark

You can check the status of PLC connection after project data is transmitted into XGT Panel.

6.1 PLC Communication Configuration Settings

You can select [Settings] button to change PLC communication settings

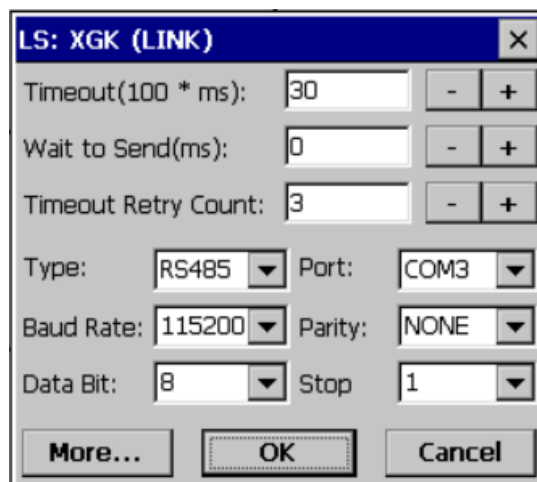
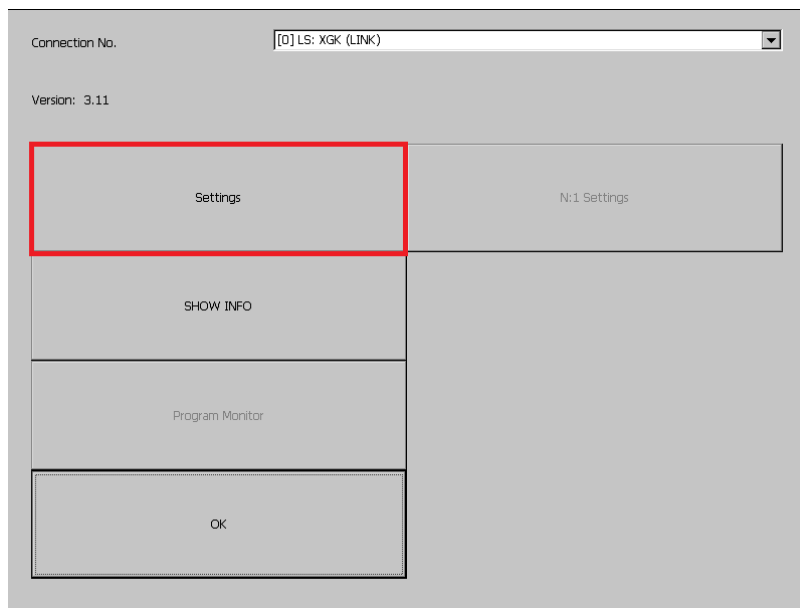

[PLC Communication Configuration setting]

Remark

- PLC Communication Configuration setting dialog box may look different.
- For further information about the settings, please refer to the PLC user manual.

6.2 Connection Information

You can check the setting items for the connection with PLC such as vender of PLC, target device, connection type, ip address, connection information and timeout value in the XP-Builder.

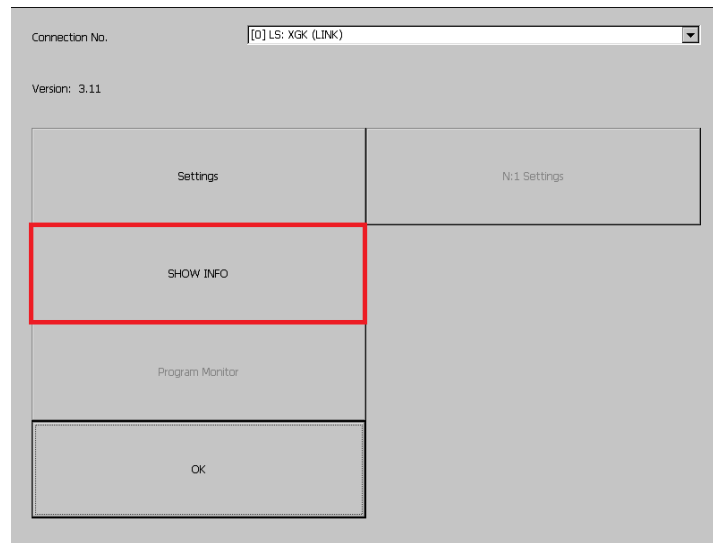

Information	
Item	Contents
Connection No.	0
Vendor	LS
Target device	LS: XGK (LINK)
Connection type	RS485
Timeout value	3000msec
Send wait value	0msec
Retry value	3

Remark

Connection No. → 0 to 15 connections can be made.

6.3 PLC Information

You can check CPU type of PLC, operation mode, state, version, and scan time.

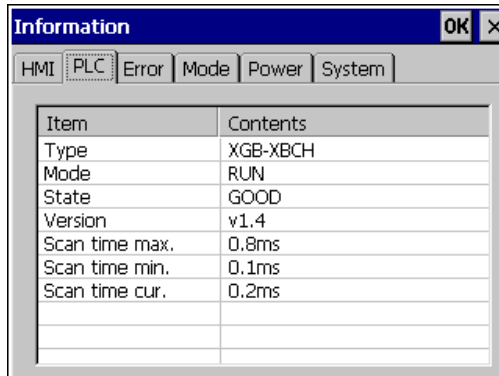

Remark

The following PLC is available for view of PLC information.

- MASTER-K CPU, FEnet, Cnet
- GLOFA-GM CPU, FEnet, Cnet
- XGK/XGB/XGI/XGR CPU, FEnet, Cnet

6.4 History of PLC Error

You can check the PLC Error History.

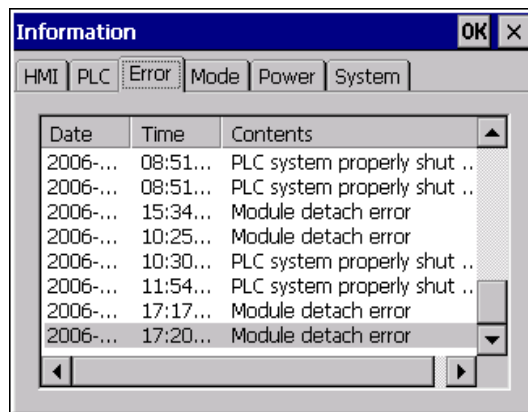

Remark

The following PLC is available for viewing Error History.

- MASTER-K CPU doesn't have the Error History.
- GLOFA-GM CPU, FEnet, Cnet
- XGK/XGB/XGI/XGR CPU, FEnet, Cnet

6.5 History of PLC Mode Conversion

You can check the history about our PLC's RUN/STOP operation mode.

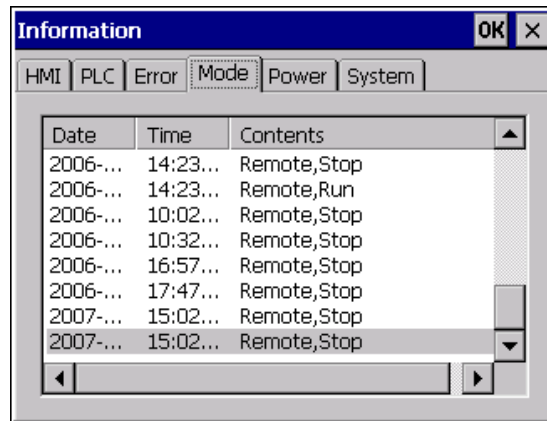

Remark

The following PLC is available for viewing PLC operation mode conversion history.

- MASTER-K CPU doesn't have the history about operation mode conversion.
- GLOFA-GM CPU, FEnet, Cnet
- XGK/XGB/XGI/XGR CPU, FEnet, Cnet

6.6 History of PLC Power

You can check the history about when PLC was turned on and off

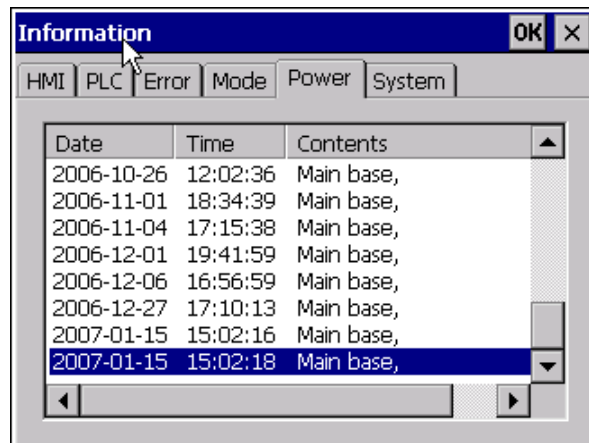

Remark

- The following PLC is available for viewing the history of when our PLC was turned off and on.
- MASTER-K CPU doesn't have the history about when our PLC was turned on and off.
 - GLOFA-GM CPU, FEnet, Cnet
 - XGK/XGB/XGI/XGR CPU, FEnet, Cnet

6.7 History of PLC System

You can check history about PLC system.

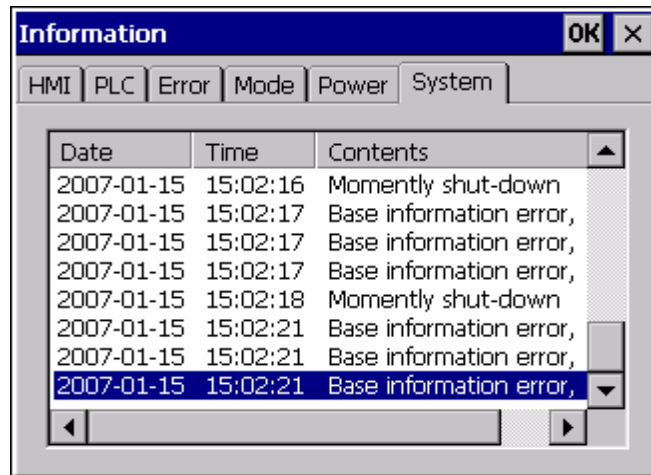

Remark

The following PLC is available for viewing history about system.

- MASTER-K CPU doesn't have the history about system.
- Only GLOFA-GM CPU (GM4C) has the history about system. Other CPUs don't have the history about system.
- XGK/XGB/XGI/XGR CPU, FEnet, Cnet

6.8 N:1 Settings

Using N:1 communication, it means communicate number of XGT Panel with single PLC.

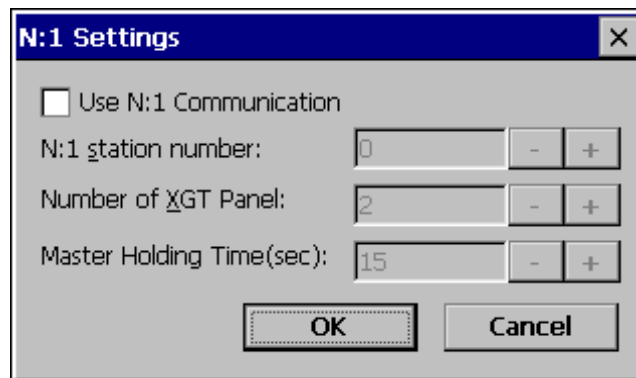
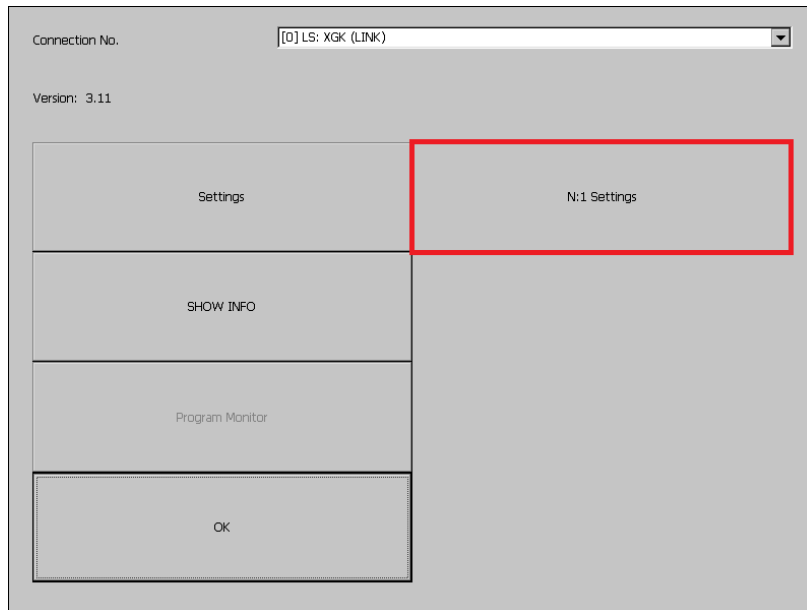

[N:1 settings dialog box]

[Explanation of dialog box]

Name	Explanation
Use N:1 Communication	N:1 Specifies whether to communicate.
N:1 station number	Enter the station number of N: 1 communication.
Number of XGT Panel	N: 1 Enter the number of XGT panels on communication.
Master Holding Time	Enter the master execution time of N: 1 communication.

Remark

For detail information about the N:1 communication, please refer to the XP-Builder manual.

6.9 Program Monitor

The programs that adopt LD language of XGK and XGB series can be monitored.



Remark

- Program Monitor driver can be downloaded from XP-Manager
- Only support for XGK/XGB CPU, Cnet, Enet communication
- To enable the [Program Monitor] button, program monitor should be checked in which locates in the XP-Builder project property menu.

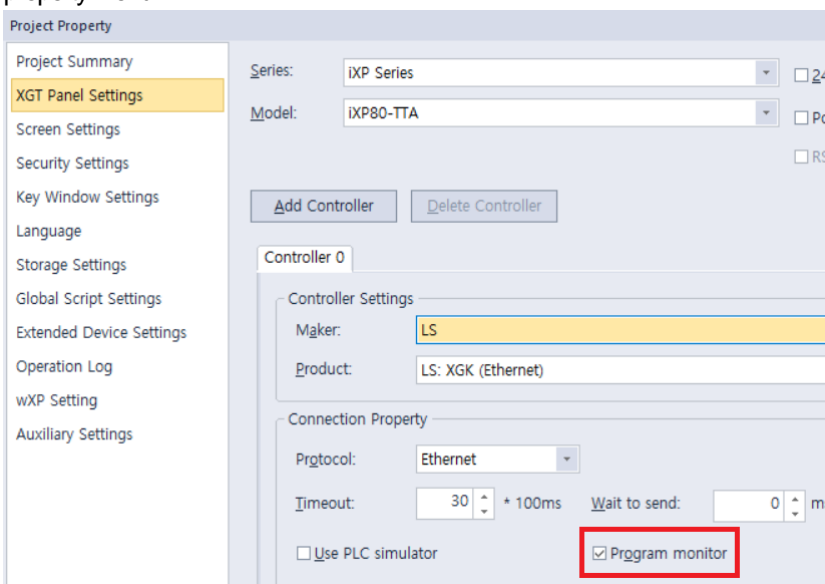

Chapter 7 Storage Function

7.1 General Introduction

Downloading the user project made in XP-Builder from PC, uploading the project stored in the device to PC, updating the device and etc are available through connection with XGT Panel with Serial cable or Ethernet cable generally. However, when those connections are not available, you can use SD card and USB storage equipment

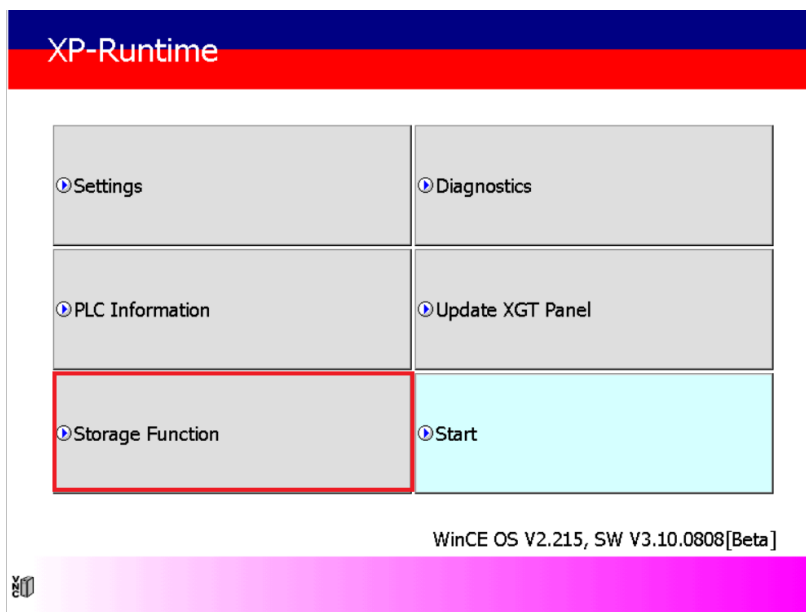

1. If you touch [Storage Function] on the menu, the following dialog box is displayed.

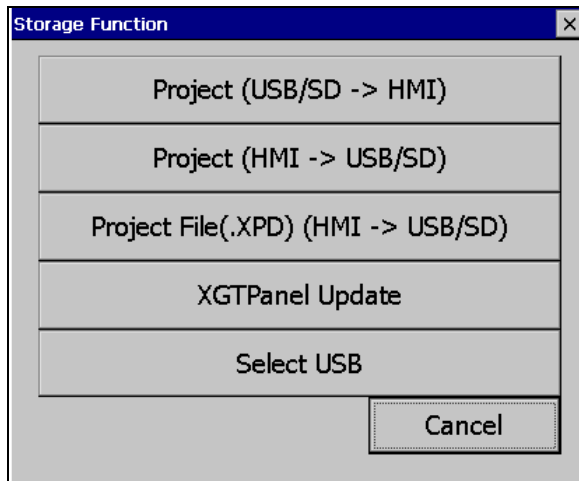

Menu	Description
Project (USB/SD -> HMI)	To download a project from an external storage device to the XGT Panel
Project (HMI -> USB/SD)	Save project from device to external storage device
Project File(.XPD) (HMI -> USB/SD)	To transfer project data backed up to an external storage device from XGT Panel
XGTPanel Update	To update the XGT Panel Software from an external storage device
Select USB	When two or more USBs are connected to the device, select the USB to save

7.2 Project Download [Project (USB/SD → HMI)]

1. If you touch [Project Download], the following dialog shows.

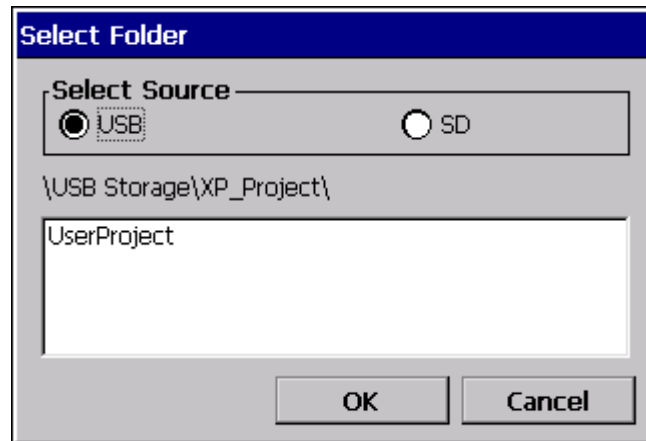

2. Project storage path of USB memory, SD card is displayed as below..

- USB: \USB Storage\XP_Project\
- SD: \SD Storage\XP_Project\

If you want to download a project using a storage device, it must be stored in the directory in the above path.

3. Select one among directory lists and touch [OK].

4. Touch [OK] button, then download will start.

7.3 Project Download [Project (HMI → USB/SD)]

1. When you touch [Project (HMI → USB/SD)] in the storage function menu, the following dialog box is displayed.

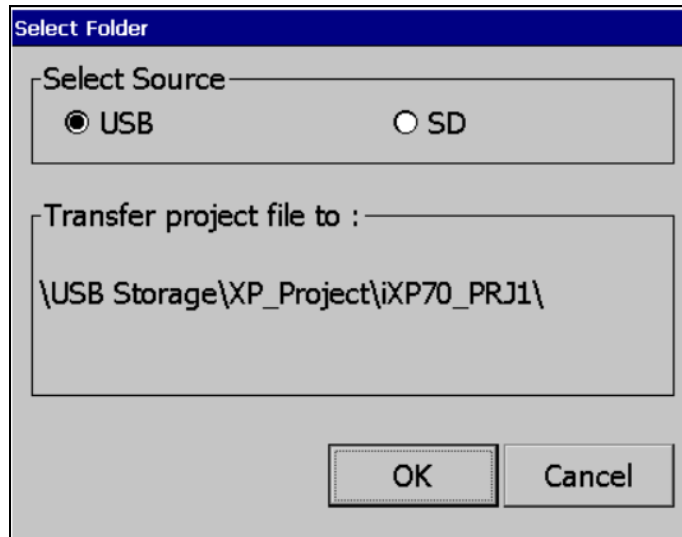

2. Project storage path of USB memory, SD card is displayed as below..

※ The folder name under USB or SD StorageXP_Project\ is automatically set to PRJ1 after the device type name.

(The project to be saved afterwards automatically increases by 1 in the order of PRJ2, PRJ3.)

EX)

- \\USB Storage\XP_Project\iXP70-PRJ1\

- \\SD Storage\XP_Project\iXP70-PRJ1\

3. Touch the [OK] button to transfer the project backup file in the machine to the path of the selected storage device.

4. It is possible to transfer directly between the same devices by using the project saved in the storage device.

(This function is applied only to the same model and is not downloaded to a different model than the uploaded project.)

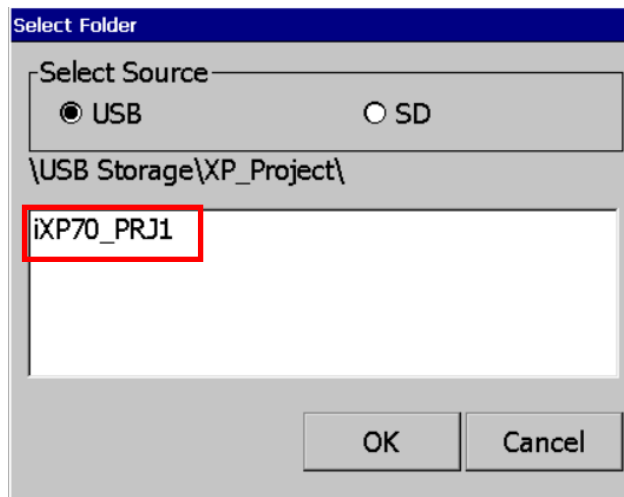

7.4 Project Upload Project File(.XPD) (HMI -> USB/SD)

1. If you touch [Project File (.XPD) (HMI -> USB/SD)] in the storage function menu, the following dialog box is displayed..

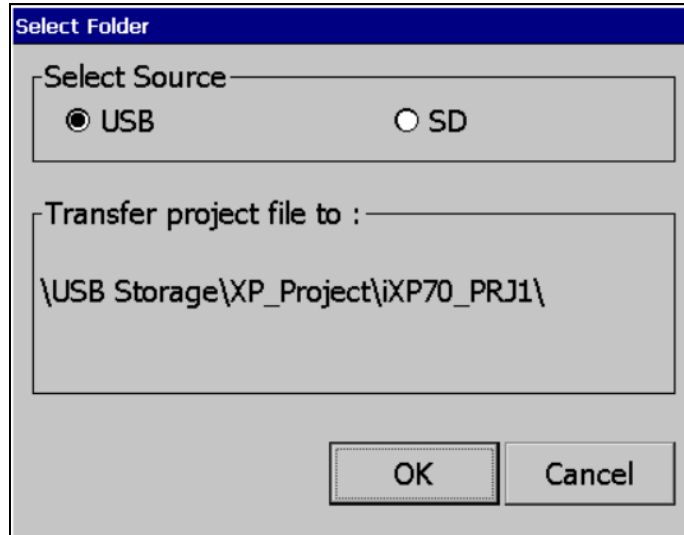

2. The upload path of USB memory and SD card is displayed as below

- USB: \\USB Storage\\XP_Backup\\
- SD: \\SD Storage\\XP_Backup\\

3. Touch the [OK] button to transfer the project backup file in the machine to the path of the selected storage device.

4. The project backup file must be downloaded to download the project backup file when downloading the project.

If not selected, the project backup file is not stored in the device and therefore cannot be transferred to the storage device.

7.5 Updating the device using a storage device

1. If you touch [Project Upload], the following dialog shows.

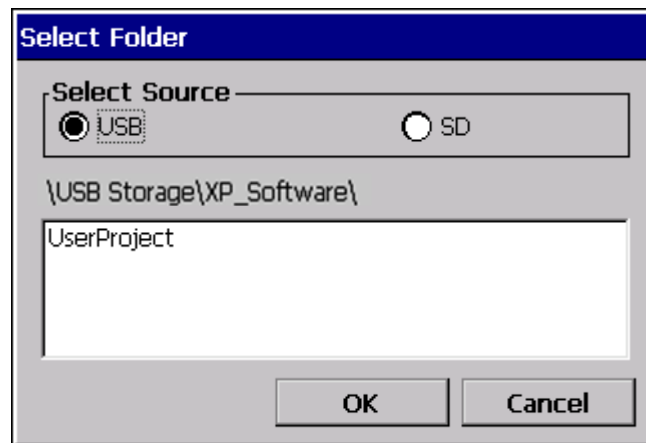

2. Please select the targeted external memory in "Select Source". Following path is indicated depending on the selected external memory
- USB: \USB Storage\XP_Software\
 - SD: \SD Storage\XP_Software\

In case of updating the device by using storage equipment, the XGT Panel Software project should be saved in the one lower directory between those two directories.

3. If you touch [OK] button, the device is updated with XGT Panel Software in the designated path.

7.6 Storage device selection function [Select USB]

1. When multiple USB devices are connected to the XGT Panel, you must select a device for uploading, downloading, or backing up projects. You can change your selection at any point during a project.

To select a USB storage device:

In the XGT Panel main menu, touch[Storage Function], then Touch [Select USB]

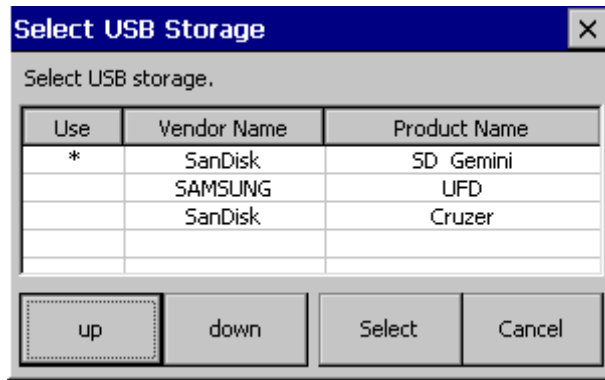

2. Select device from the list of connected devices

- Use: The selected device is indicated with an asterisk(*).
- Vendor Name: The device manufacturer
- Product Name: The device name
- Up/down: Move to the next or previous item
- Select: Save your selection
- Cancel: Exit without saving changes

7.7 Select USB Storage Device while Monitoring a Project

1. To select a storage device while monitoring a project, on the XGT Panel, touch [Start] to open the Select USB Storage window. Select a USB device and touch [Select].

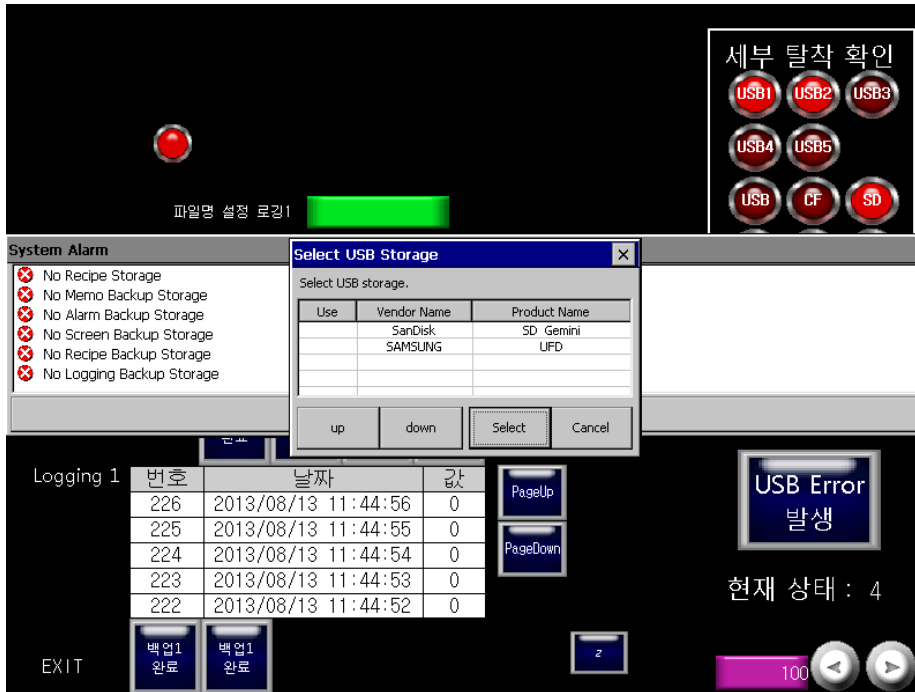

2. To select a storage device from the status bar, touch [USB].



3. If the selected device is disconnected or if another device is connected, the Select USB Storage window appears again.

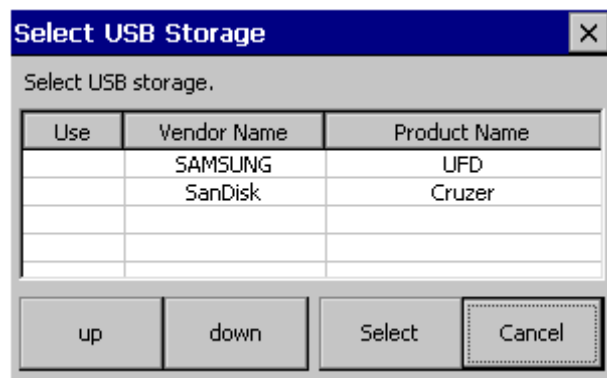

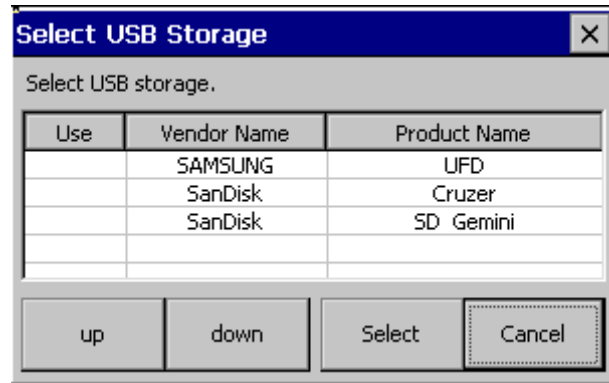

Remark

- (1) Do not remove or turn off the selected USB device while running a project. Project data may be corrupted and cause the project to malfunction.
- (2) Do not erase or move the directory or folders on the USB device. Doing so may cause data to be corrupted or the project to malfunction.
- (3) When removing an SD Care memory, turn on the safe removal switch on the back of the panel and remove the device only after the switch lamp turns off. Failure to do so may cause the device to be unrecognized when you reconnect it.
- (4) When you reconnect a device, allow at least three (3) seconds to establish the connection. Failure to do so may cause the device to be unrecognized when you reconnect it.
- (5) When one USB device is connected, turning on the power to the panel will set the USB device as the main storage device automatically.
- (6) When connecting multiple devices, the first device connected is set at the main storage device automatically. However, removing devices does not change the selected storage device automatically. You must reselect the main storage device.

Chapter 8 XGT Panel S/W Update

8.1 General Introduction

It describes the function for updating the XGT Panel software.

Basically you can optimize XGT Panel when you download the project file in XP-Builder. Please use this function only in case of updating XGT Panel specially.

New function is added to XGT software, you need to update a version of XGT Panel
Please refer to the following.

[Method]

Select [Upgrade -> Update XGT Panel] on the XGT Panel's main screen. Then XGT Panel becomes update mode. In order to return to the main screen, touch a screen for 3 seconds.

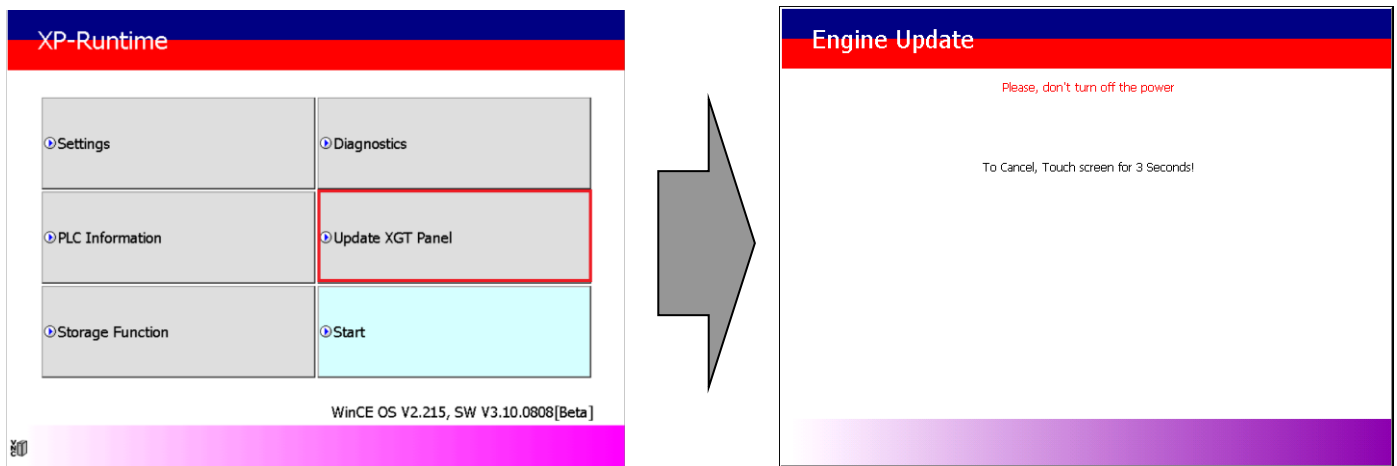

After downloading XGT Panel software from LS ELECTRIC website, make a temporary folder and save it.

Designate the folder where the software will be saved in the XP-Builder's [XGT Panel Update] windows and update XGT Panel by [Send] menu. For more detailed information about XP-Builder, please refer to the XP-Builder user manual.

Remark

Do not remove communication cable or turn off the device during updating. It may cause the abnormal operation.

Chapter 9 File Backup through External Storage Equipment

Describes on management function about external storage equipment saving backup data of logging, recipe, and screen image
(1) XGT Panel can back up the logging, recipe, and screen image data at SD card or USB storage equipment according to setting in XP-Builder.

(2) In case there is no space for backup in the designated storage equipment, it continues backup deleting previous data or stops backup according to setting in XP-Builder

(3) Monitors attachment status of backup equipment at XP-Builder.

(4) In case the applicable storage device is not in use with safety removal switch of SD card in operation, LED will be turned off right away. If the applicable storage device is in use, however, LED will be turn off as its use is over. Data backup will be done regularly only when LED is turned off and the device is removed.

9.1 Path Structure in case of File Backup

Backup path structure of logging, recipe, and screen image is as follows.

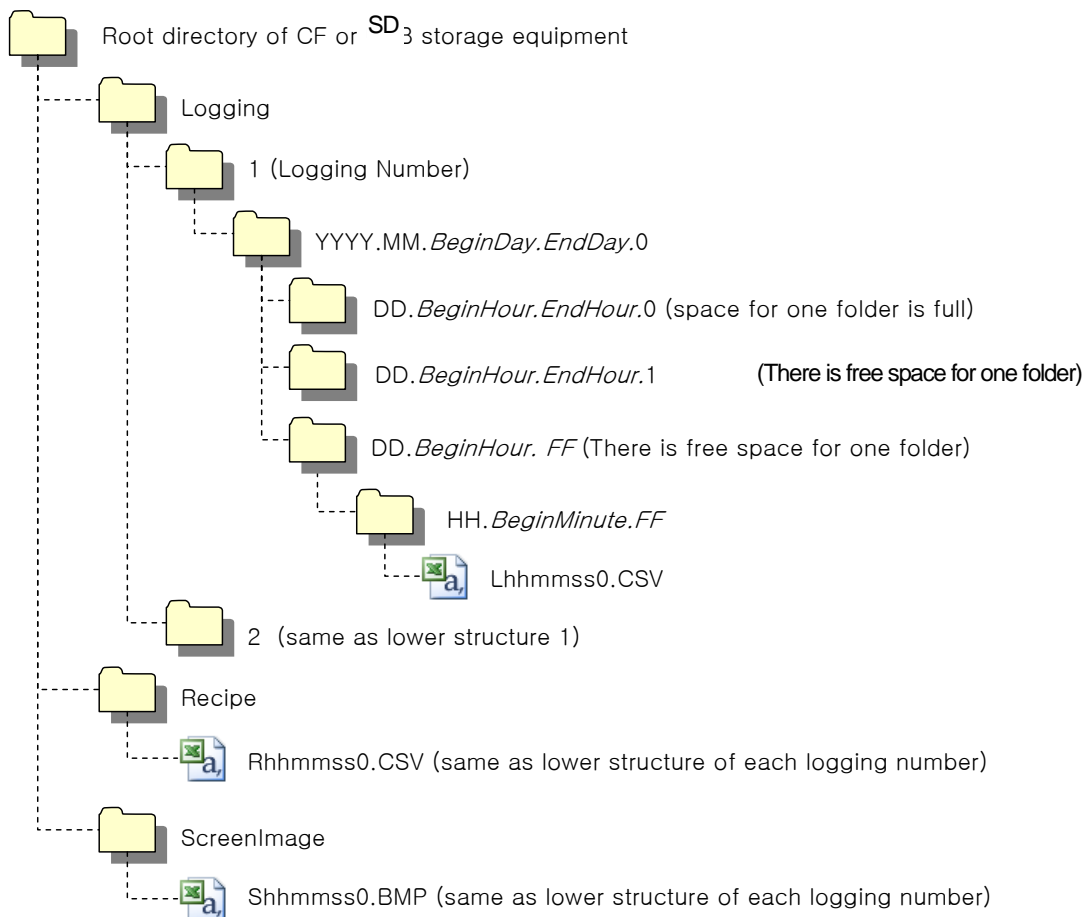

1. Path structure in case of logging backup

(1) Directory named 'Logging' is created under the root directory of USB memory.

(2) The directory whose name is logging number is created under Logging directory.

(3) The directory whose name is year, month is created under Logging number directory.

- (a) Includes day directory under
- (b) Up to 500 day directories can be created.
- (c) Name of year, month directory includes the firstly created day information under its directory

Ex) In case directory is created in 2010, October and includes directory since 15th under, directory's name is
: 2010.10.15.FF

FF at end means the directory can save more data created in 2010, October (currently, the number of lower directory is 500 or less)

(d) In case month is changed, changes directory name to day information of last created day directory.

Ex) In case month becomes November from October and directory from 15th directory to 30th have been created in 2010, October directory.

: 2010.10.15.30.0

(e) Though month is not changed, in case the number of day directory under year, month directory is 500 or above, directory name is changed into name including day information of last created day directory.

Ex) In case the number of directory from first to 15th is 500 or above in the directory created in 2010, October.

: 2010.10.01.15.0

(f) In case there is the year, month directory having same start day and end day when changing directory's name due to over 500 day directories or change of month, last digit index number increases.

Ex) In case there are three year, month directories that are having over 500 day directories created in October first and 2010 year October directory

: 2010.10.01.01.0

: 2010.10.01.01.1

: 2010.10.01.01.2

(4) Day directory is created under year, month directory

(a) Hour directory is created under day directory

(b) Day directory can have up to 500 hour directory

(c) Name of day directory includes not day information but also hour information of first created hour directory

(d) Relation between day directory and hour directory is same as relation between year month directory and day directory.

(5) Directory whose name includes hour information is created under day directory.

(a) Hour directory includes backup file under

(b) Hour directory can include up to 500 backup file

(c) Name of time directory include not only hour information but also minute information of first created file under

(d) Relation between hour directory and backup file is same as relation between year, month directory and day directory.

(6) Name of logging backup file includes the created hour, minute, second information.

(a) Backup file is created in CSV format.

(b) File name start with 'L' meaning logging and includes hour, minute, second, index information

(c) In case backup file is created at the same time in terms of second, index information at the end of file name increases.

2. Path structure in case of recipe backup

(1) Directory named 'Recipe' is created under USB/SD storage equipment root directory.

(2) Year, month directory is created under Recipe directory

(3) The lower directory structure is same as that of logging backup path structure.

(4) Name of recipe backup file includes the created hour, minute, second information.

(a) Backup file is created in CSV format.

(b) File name start with 'R' indicating recipe and includes hour, minute, second, index information.

(c) In case backup file is created at the same time in terms of second, index information at the end of file name increases.

3. Path structure in case of screen backup

(1) Directory named 'Screen Image' is created under USB/SD storage equipment root directory.

(2) Directory whose name is year; month is created under Screen Image directory.

(3) The lower directory structure is same as that of logging.

(4) Name of screen image backup file includes hour, minute, second information.

(a) Backup file is created in bitmap format.

(b) File name starts with 'S' and includes hour, minute, second, index information.

(c) In case backup file is created at the same time in terms of second, index information at the end of file name increases.

4. Structure of path at memo backup

(1) 'Memo' directory will be formed at the sub route directory of USB/SD storage device.

(2) Directory in the name of Year and Month will be formed below the Memo Directory.

- (3) Structure of directory thereafter is same as that of logging backup route.
- (4) Memo backup file has the name made of hour/minute/second when it was created.
 - (a) Backup file is created in the type of bitmap.
 - (b) File name starts with 'M' that represents the screen image, which includes the index information of hour, minute, and second thereafter.
 - (c) In case backup file is created at the same time up to second, it increases the far end index information.
5. Structure of path at live image recording
 - (1) 'Movie' directory will be formed at the sub route directory of USB/SD storage device
 - (2) Recorded live image is stored below the Movie Directory.
 - (3) Live image file has the name made of year/month/date/hour/minute/second information when it was created.
 - (a) Backup file will be created in AVI type. H.264 and Mp3 were used for Video CODEC and Audio CODEC respectively.
 - (b) File name starts with 'MOV' that represents screen image, which includes data and hour information thereafter.
 - (c) Live image can be stored up to the number 1,000 files. This number can be designated at the special device settings of XP-Builder.
6. Structure of path when Blue Screen of camera image and live image is created
 - (1) 'MovieStill' directory will be formed at the sub route directory of USB/SD storage device.
 - (2) Recorded live image will be stored below MovieStill directory.
 - (3) Blue screen image file has the name made of year/month/date/hour/minute/second information when it was created.
 - (a) Backup file will be created in JPG type.
 - (b) File name starts with 'STL' that represents screen image, which includes data and hour information thereafter.
 - (c) Live image can be stored up to 1,000 files. This number can be designated at the special device settings of XP-Builder.

Remark

- (1) When changing device time, in case of changing current time into after time, we guarantee the normal operation. But in case of changing current time into early time, we don't guarantee the normal operation. In this case, you have to delete directory including the changed hour and its lower directory for normal operation. For example, if you change time from December 10th to December 5th, you have to delete year, month directory created in December 10th and restart the device
- (2) Sorting by project is not supported for each logging, recipe, screen image. For example, there are no.1, 2, and 3 logging groups in the project A. And in case each logging group backups the file, 1, 2, 3 directories are created and each data is saved under each directory. Then, in case file backup occurs in the project B having no.1, 2 logging group, backup file is created in same directory of project A. In this case, you have to sort the backup files of project A and B based on the created time.

9.2 Operation setting when there is no space for backup

You can designate in the XP-Builder whether to cancel the backup or delete the oldest backup file and execute backup when there is no space in the storage equipment.

[Project Property Setting -> Storage Settings -> Backup Storage -> Delete old file if disk full]

1. In case of backup, deleting the oldest data
 - (1) In case there is no space for backup, searches the oldest year, month directory under Logging, Recipe, Screen Image. (But in case of Logging, finds under Logging number directory. That is, when executing backup about Logging number 2, in case there is no backup data in Logging number 2 directory and there is data only in logging number 1, data of logging number 1 is not searched/deleted.)
 - (2) Searches the oldest day directory under the oldest year, month directory.
 - (3) Searches the oldest hour directory under the oldest day directory.
 - (4) Deletes the oldest backup file under the oldest hour directory
 - (5) Checks the space and if more space is necessary, the above steps of (1) ~ (4) are repeated and checks the space.
 - (6) When deleting file, in case all data in time directory are deleted, relevant hour directory is deleted.
 - (7) When deleting hour directory, in case all hour directories in day directory are deleted, relevant hour directory is deleted.
 - (8) When deleting day directory, in case all day directories in year, month directory are deleted, relevant year, month directory is deleted.

Remark

- (1) In unknown directory or file (user file or directory), searches the oldest thing among normal backup files except unknown directory or file.
- (2) In case there is nothing except user data in now searched directory, backup operation fails. XGT Panel can't delete user data, at this point, operation stops.

9.3 Structure of path of video file and video capture files

1. Movement when file is added

(1) When the name of created file is MOV_120220_121212.avi, the directory will be created as follow;

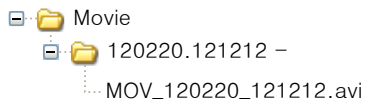

(2) When MOV_120220_200101.avi file is created again thereafter, the applicable directory is added by subdirectories as follow until it fills 500 files.

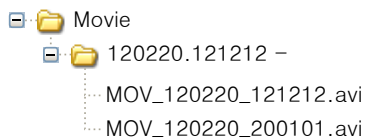

(3) When 500 files are filled with MOV_120330_110101.avi as its last one, the name of directory will be change as follow;

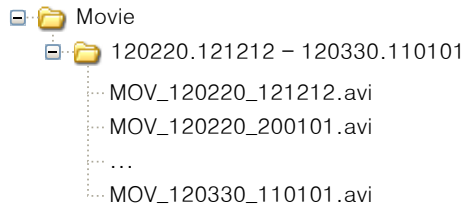

(4) When the 501st file (MOV_120330_110230.avi) is created, a new directory will be created as follow;



2. Movement when the domain is short or it exceeds the designated limit

- (1) In case of designating the property related with storage device for the XP-Builder project – At the time of setting video file and video capture, if you check at [Delete Old File when Domain is full], it operates by deleting the oldest file when the space is short or it exceeds the limited number of directories. When you release such check, it stops operation together with error code when the space is short.
- (2) When the number of directories filled with 500 files becomes 100;
 - It deletes the oldest file in the oldest directory. When the directory gets empty, that directory is also deleted.
- (3) When there is no available space in the storage device;
 - It deletes the oldest file in the oldest directory. It requires minimum 10MB to save the live image and minimum 1MB to save video capture file. It deletes out the oldest file one by one until such space is secured. When the directory gets empty, that directory is also deleted.

3. ActiveSync –related movement

- (1) When in connection with ActiveSync

When in connection with ActiveSync, it doesn't make any specific operation. In case you deletes and move the file in the storage device with ActiveSync in connection, the applicable mode is not reflected in the motion of device. That is, deletion of file doesn't cause update of the device of the number of video files or the value of video capture file device.

- (2) When out of connection with ActiveSync

When out of connection with ActiveSync, it renews the list of stored video file and video capture file in the storage device again. During this time, it is impossible to start recording or replaying. Through the status device, you can confirm when the motion of file list preparation will be stopped.

4. Motion when dismounting the storage device

- (1) When mounting the storage device

Please scan the entire video file and video capture file, prepare the list, and find out the total number. During this time, it is impossible to start recording or replaying. Through the status device, you can confirm when the motion of file list preparation will be stopped.

9.4 Monitoring Connection Status of External Storage Equipment

XGT Panels monitors connection status about external storage equipment designated when setting backup path in XP-Builder. The following figure is backup path specified in XP-Builder.

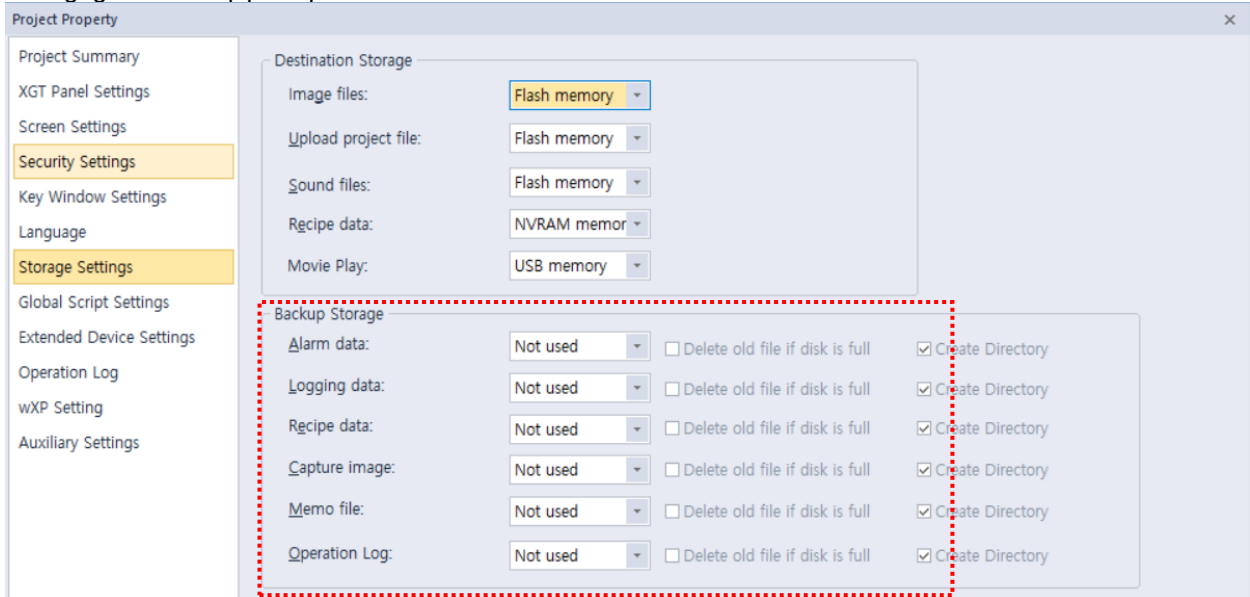

In order to use this monitoring function, you have to set about system alarm window

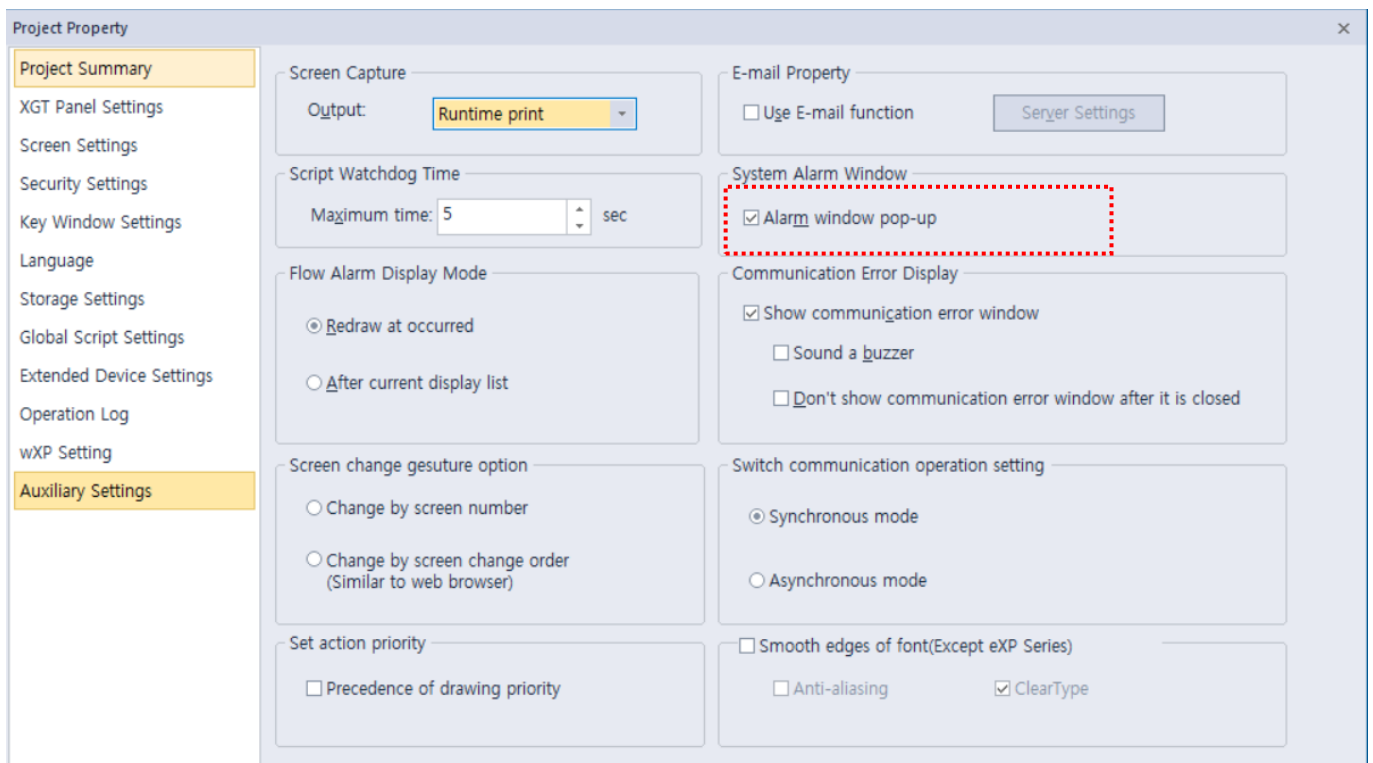

Chapter 9. File Backup through External Storage Equipment

In case USB storage equipment is removed during operation after setting the path for saving Logging backup file as USB storage equipment and downloading the project into device, the designated system alarm (HS951.0) is set. In case storage equipment is equipped again, alarm is reset.

In case USB storage equipment is removed during operation after setting the path for saving Recipe backup file as USB storage equipment and downloading the project into device, the designated system alarm (HS951.1) is set. In case storage equipment is equipped again, alarm is reset.

In case USB storage equipment is removed during operation after setting the path for saving Screen Image backup file as USB storage equipment and downloading the project into device, the designated system alarm (HS951.2) is set. In case storage equipment is equipped again, alarm is reset.

Internal address of the designated system alarm can be checked in XP-Builder as follows.

	Device	Data Type	Description
1	HS950.0	BIT	NVRAM Low Battery Warning
2	HS950.1	BIT	NVRAM Invalid Data Warning
3	HS951.0	BIT	No Logging Backup Storage
4	HS951.1	BIT	No Recipe Backup Storage
5	HS951.2	BIT	No Screen Backup Storage
6	HS951.4	BIT	No Printer
7	HS950.8	BIT	USB Over Current Warning
8	HS951.3	BIT	No Alarm Backup Storage

9.5 Safety Removal Switch

In order to remove the storage device, you can use safety removal switch to guarantee that data was backed up with safety

LED is turned off if you remove the storage device right away without any motion of safety removal switch. If you operate safety removal switch, LED will be turned off right away if there is no backup function with storage device in current use. In that case, LED will be turned off when such work is all over, and will internally turn off the connection with the storage device. That is, when LED is turned off, you cannot backup anything in the storage device, and may not use data in the storage device such as file recipe, etc. Therefore, you need to remove and then mount the storage device again in order to operate safety removal switch and then use it again after LED is turned off. When you operate safety removal switch and re-mount the storage device, you are required to re-mount it at least after 5 seconds.

With the following function in operation, LED will not be turned off even with safety removal switch in operation. LED will be turned off with the applicable mode completed. It will not be turned off during the creation of backup data or during the Read mode in the XP-Builder. It will not be turned off during the Load mode as the image stored in XP-User Image in the storage device is used as part image. It will not be turned off during the file recipe Write or Read mode. It will not be turned off during Backup Data Read mode in XP-Server using the XP-Link communication. It will not be turned off during the Inquiry mode of the list of backup files to be uploaded from the XP-Builder. It will not be turned off during the Load mode of sound file or image included in the Project. It will not be turned off during the Read mode of Project Backup Data with the storage device or from the XP-Builder. It will not be turned off when it downloads the project in the device using XP-Builder or storage device. It will not be turned off when it is changing the start menu image. It will not be turned off with the ladder monitor program stored in the storage device in operation.

Function	Sub-classification	Movement
Data Backup	Alarm	Write
	Logging	Write
	Recipe	Write
	Screen	Write
	Memo	Write
	Video	Write
	Still Shot	Write
Data Upload	Alarm	Read
	Logging	Read
	Recipe	Read
	Screen	Read
	Memo	Read
	Video	Read
	Still Shot	Read
Function-wise Data	Part Image	Read
	File Recipe Edit	Read/Write
	File Recipe Transfer	Read/Write
Web Server	Webpage Create	Write
XP Link File Transfer		Read
File List Inquiry		Read
Project Upload	Project Backup – Communication	Read
	Project Backup - Storage Device	Write
Project Download	Image	Write
	Sound	Write
	Project Backup	Write
Ladder Monitor	Download	Write
	Execute	Read
Changing default Image		Read
Storage Device Download	Project Data	Read

Chapter 10 Installation and Wiring

10.1 Installation

10.1.1 Installation environment

This machine has high reliability regardless environment. But for reliability and stability, be careful the followings

(1) Environment condition

- (a) Install at the panel which can protect this machine from water and dust.
XGT Panel is designed by IP65 Standard in front parts and IP20 Standard in rear parts.
- (b) Install at the place where impact and vibration is not continuously applied.
XGT Panel is designed to meet IEC standard (IEC 61131-2).
- (c) Do not expose this machine to direct light.
- (d) Do not install at the place where rapid temperature change can occur.
Moisture by rapid temperature change can cause malfunction and damage.
- (e) This machine should be installed within 0 ~ 50°C, otherwise the screen may be changed or cause malfunction
- (f) This machine should be installed within 10~85% relative-humidity.
Moisture by rapid temperature change can cause malfunction and damage.
- (g) Avoid corrosive gas and burnable gas.

(2) Installation construction

- (a) When doing screw's processing or wiring construction, be careful that the remains do not enter the XGT Panel inside.
- (b) Install at the place where you can easily control.
- (c) Do not install with high voltage machine within same Panel.
- (d) Keep distance of more than 100mm from duct for wiring and peripheral machine.
- (e) Ground at the place where few noises develop.

(3) Anti-heat design of control panel

- (a) In case of installing XGT Panel in the airtight panel, consider the heat by other machine as well as own heat. In case that the air circulates through a ventilating opening or a general pan, XGT Panel system can be influenced by in-draft of dust or gas.
- (b) We recommend you to install a filter or to use an airtight heat exchanger.

Remark

(1) Protection standard

- 1) Ingress Protection (IP) is based on the IEC 60529 Standard for degrees of protection provided by enclosures. It includes the degree of protection against solid objects and of protection against water ingress.
- 2) IP65 rating guarantees the enclosure is dust proof (6) and protected against jets of water (5).
- 3) IP20 rating guarantees protection from solid foreign objects of 12mm diameter and greater (2), but it does not guarantee protection from water ingress.

Element	Numerals or letters	Meaning for the protection of equipment	Meaning for the protection of persons
Code letters	IP		
First characteristic numeral	0 1 2 3 4 5 6	Against ingress of solid foreign objects (non-protected) ≥ 50 mm diameter ≥ 12.5 mm diameter ≥ 2.5 mm diameter ≥ 1.0 mm diameter Dust-protected Dust-tight	Against access to hazardous parts with (non-protected) Back of hand Finger Tool Wire Wire Wire
Second characteristic numeral	0 1 2 3 4 5 6 7 8	Against ingress of water with harmful effects (non-protected) Vertically dripping Dripping (15° tilted) Spraying Splashing Jetting Powerful jetting Temporary immersion Continuous immersion	
Additional letter (optional)	A B C D		Against access to hazardous parts with back of hand Finger Tool Wire
Supplementary letter (optional)	H M S W	Supplementary information specific to: High-voltage apparatus Motion during water test Stationary during water test Weather conditions	

<Source: IEC60529>

(2) Caution

- 1) The XGT Panel is designed to mount on the panel, so that the front side meets the standard. However, it does not guarantee the installation environment.
- 2) The product may malfunction or break down if the installation environment is not suitable for the protection rating.
- 3) The standard is only for protection from dust and water. Use care to protect against oil, corrosives, or metal particles.
- 4) If the gasket breaks down due to exposure to chemicals or continuous vibration, the protection from dust and water may be weakened.
- 5) When you install or mount the XGT Panel, be careful not to damage the product.

10.1.2 Notice in handling

It describes the notice from opening to installation.

- Do not drop or cause heavy impact.
- Do not disassemble voluntarily. When doing this, we are not responsible for the product.
- When wiring, be careful that the remains do not enter into XGT Panel.

10.1.3 Notice in installing the panel

Here describes how to install XGT Panel in panel and notice.

(1) Panel cut

- Before installing the XGT Panel in panel, panel should be made with the following dimension.

Unit: [mm]

Classification	X (Wide)		Y (Height)		Z (Thickness)
iXP50-TTA	228.5	+1	158.5	+1	1.6-9.5
		-0			
iXP70-TTA	259.0	+1	201.0	+1	
		-0			
iXP80-TTA	301.5	+1	227.5	+1	
		-0			
iXP90-TTA	383.5	+1	282.5	+1	
		-0			

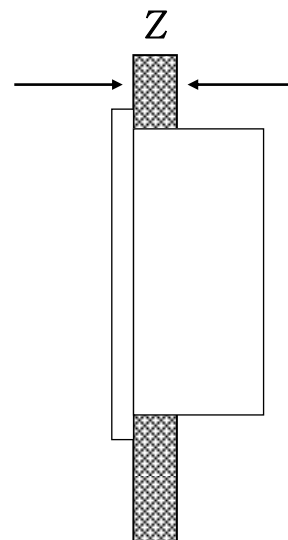
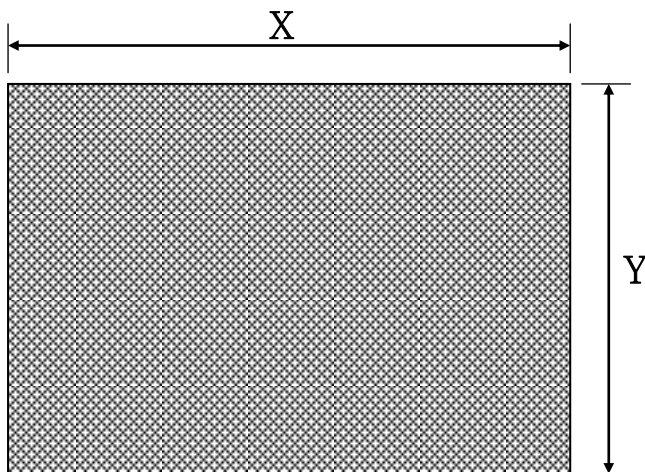

(2) XGT Panel installation

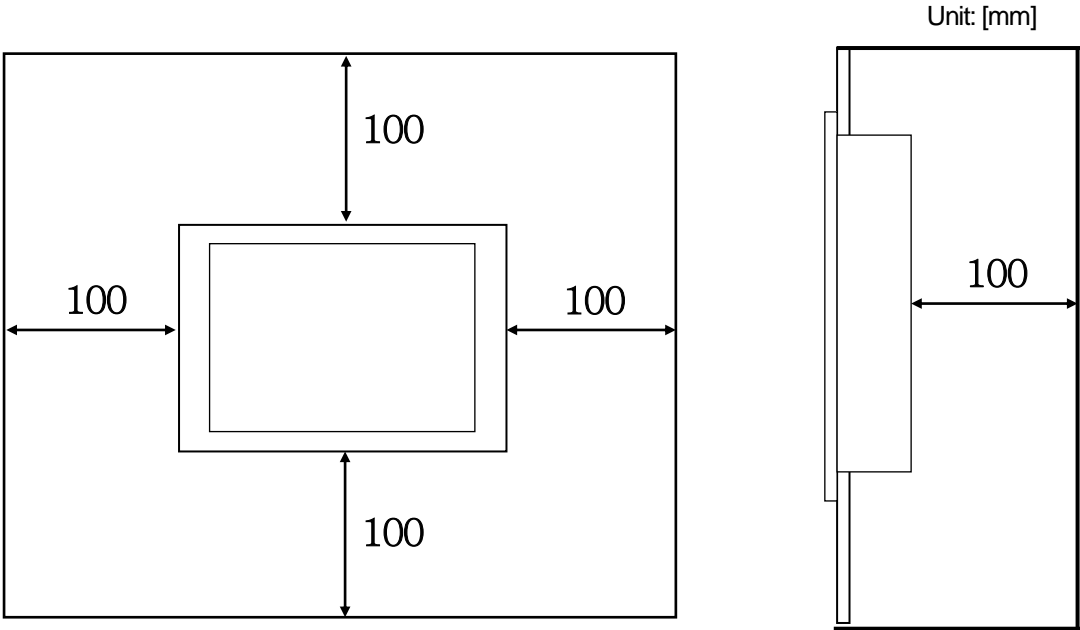

- Keep the distance of 100 mm between XGT Panel and panel per each direction.

Remark

- (1) To be affected at a minimum by the electromagnetic waves (radial noise) or heat from other controllers, it needs to keep its distance as the above explanation.
- (2) When installing, consider the power and communication cable wiring.
- (3) If the size of the panel cutout dimensions are beyond the error range (0-1mm), the contact surface between the gasket and the panel may be reduced. This may weaken the protection from water and dust ingress.

- When mounting the XGT Panel inside a panel, ensure that you use the gasket to protect against dust or water ingress.

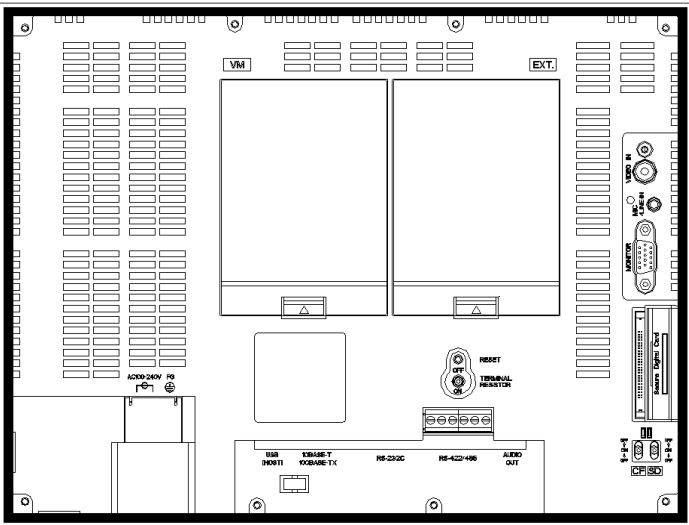

Dustproof / Waterproof gasket



Remark

(1) Use the gasket to prevent dust or other contaminant ingress.

(2) When you mount the XGT Panel on the panel, if the surface of panel is uneven, water or dust can enter the product through the gaps. This can be caused by the quality of the material (iron, aluminum, or acrylic) or the thickness, so check the installation environment carefully. Moreover, be sure to adhere the gasket and panel.

(3) If the gasket is damaged when you install the product or is deteriorated after a long period of use, it may weaken the protection from water and dust ingress. If you need to replace it, contact the agency or a service center.

(3) Installation location

- When installing the XGT Panel, consider screen and use of touch.
- When you don't see within the following angle, you may not see clearly. When installing, consider angle.

Item	Left and Right	Upper	Lower
iXP50-TTA	80 deg.	80 deg.	60 deg.
iXP70-TTA	80 deg.	60 deg.	80 deg.
iXP80-TTA	80 deg.	60 deg.	80 deg.
iXP90-TTA	80 deg.	60 deg.	80 deg.

(4) Fixation

- Fix XGT Panel to the panel using the supplied brackets provided in the OEM packaging.

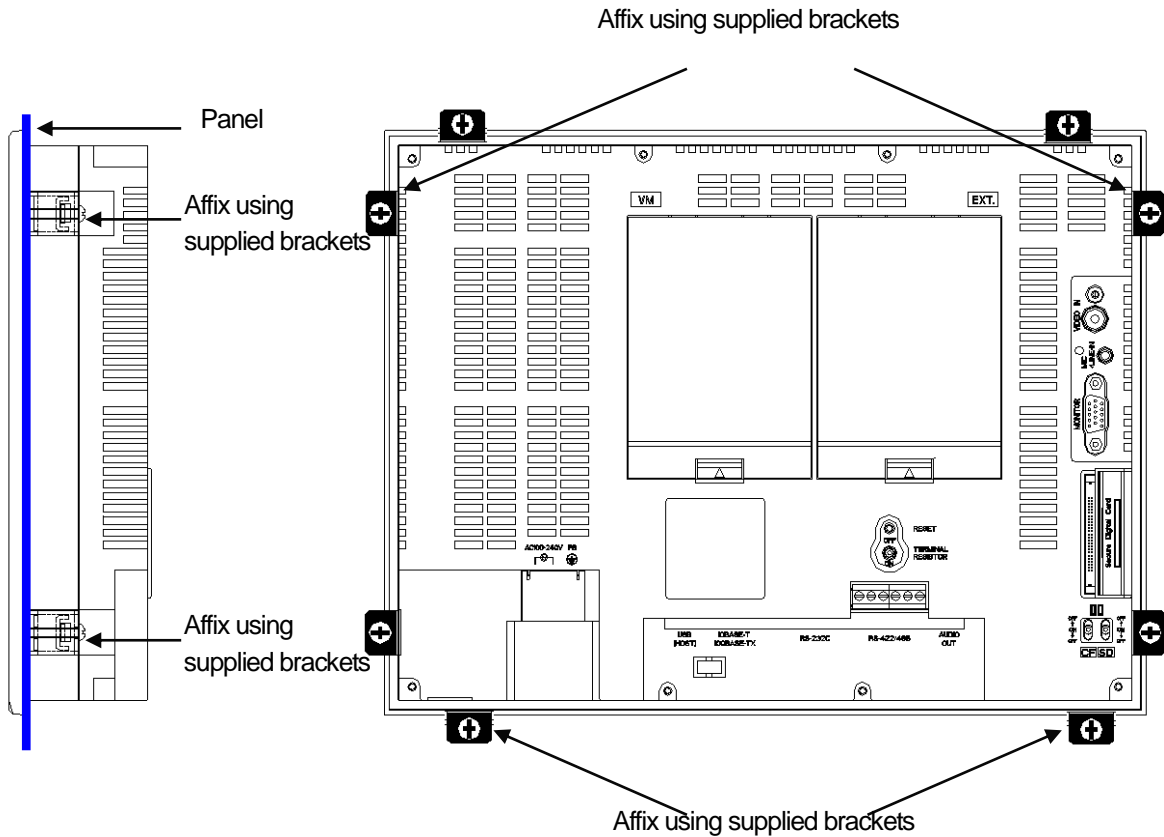

Remark

- (1) Affix the brackets on four sides of the product to prevent ingress by water and dust.
- (2) Affix the brackets top to bottom and right to left to prevent gaps.
- (3) Align the brackets vertically with the panel. The screw torque of the brackets is 6.42kgf/cm. The screw torque may vary by the quality of the panel, but it should follow the standard screw torque value for a bolt. If you apply excessive force when affixing the brackets, the XGT Panel can be damaged. This may result in touch screen errors or weaken the protection against water and dust ingress.
- (4) After mounting the XGT Panel on the panel, remove the screen protection film. Touch screen errors may result if the film is not removed. To protect the screen, use the exclusive protection sheet. To purchase a protection sheet, contact the agency or a sales office.

10.2 Wiring

It describes the wiring that you should know when installing the XGT Panel.

10.2.1 Power wiring

XGT Panel is divided into the DC product and the AC product.

Power	Name
DC 24V	iXP50-TT/DC
DC 12/24V	iXP70-TT/DC
	iXP80-TT/DC
	iXP90-TT/DC
AC 100-240V	iXP70-TT/AC
	iXP80-TT/AC
	iXP90-TT/AC



Warning

- ▶ If AC power is applied into the product for DC power, It may cause damage or fire. Be careful of connection.
- ▶ 'DC' is the product which use DC 12/24V, and 'AC' is the product which use AC 100-240V. When using the product, Please check the label in the back of the product.

The power terminal should have the following specification.

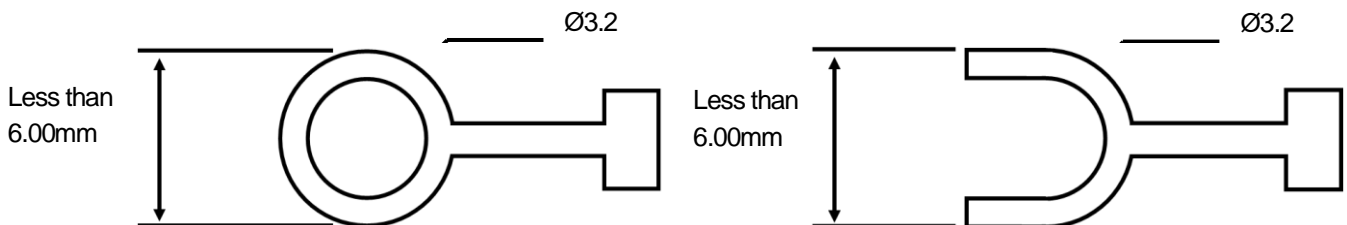

The power cable should have the following specification.

Type	Cable specification (Unit: mm ²)
Power and protection ground	1.5 (AWG16) ~ 2.5 (AWG12)

Remark

- (1) For installations where there is voltage drop, it is recommended to use stranded wire with a cross sectional area 1.5~2.5 mm².
- (2) It is recommended that cable connections are twisted and secure. Short cable runs are also recommended Between the point of supply and the XGT panel.
- (3) For safety reasons it is recommended that you use color coded outer sheaths on the conductors to aid safe terminations.
Follow local regulations when making electrical connections.

Wiring of power is as follows.

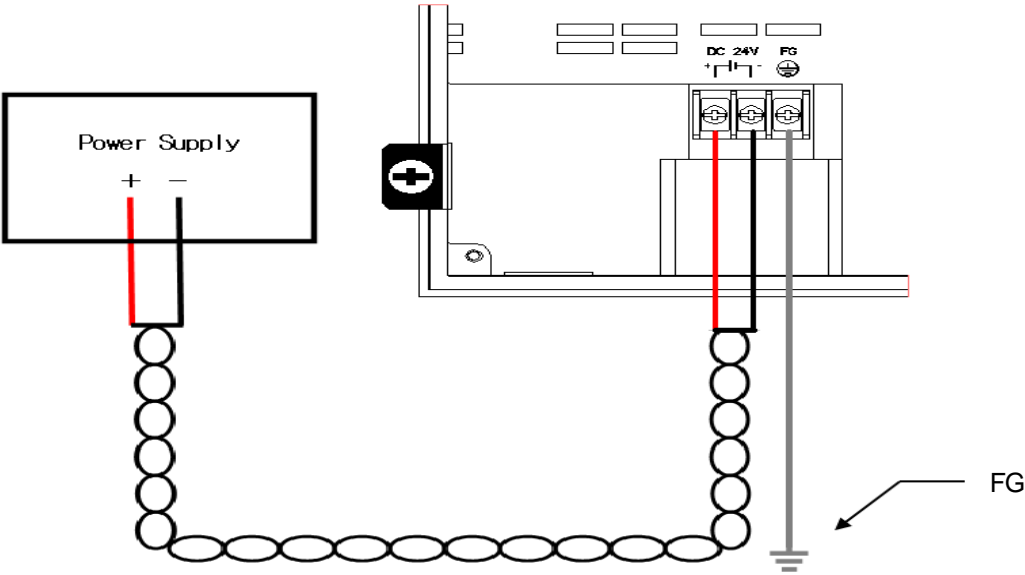

DC Power connection

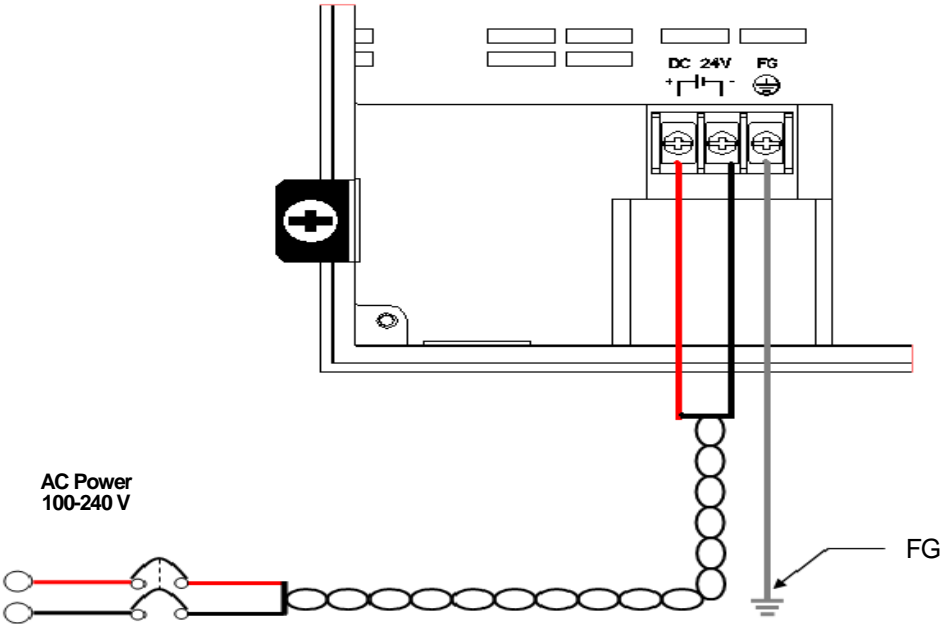

AC power connection

Remark

- (1) Use a regulated power supply transformer when the power fluctuation is bigger than the standard.
- (2) If electromagnetic interference is experienced or expected use an insulation transformer to protect the XGT panel from interference.

Separate the XGT Panel power from the I/O device and main circuit device.

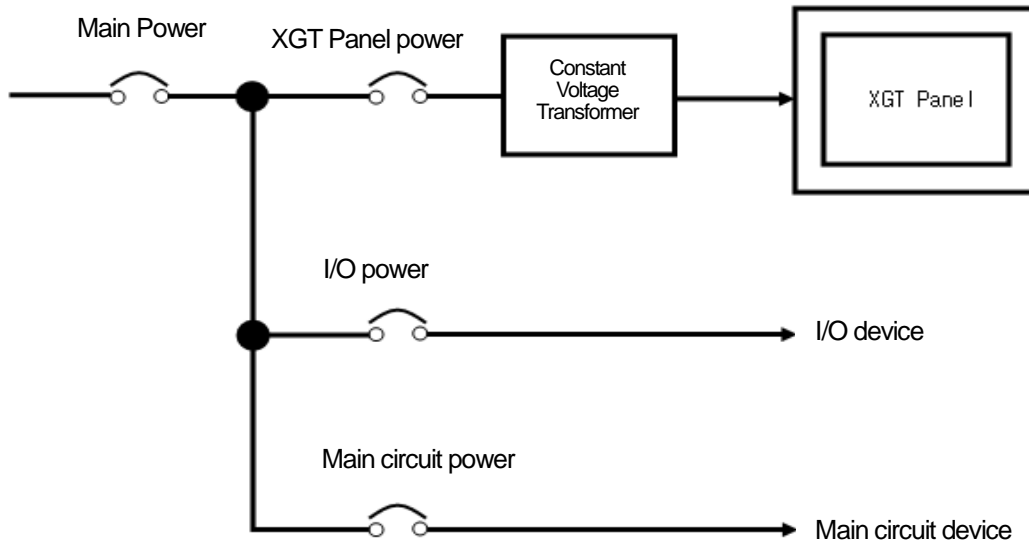

Remark

- (1) Separate the XGT Panel power supply cable from the main circuit cable (high voltage and current) and input/output cable. Maintain a minimum separation of 100mm between cables.

Use a lightning surge protector to prevent damage from lightning strikes.

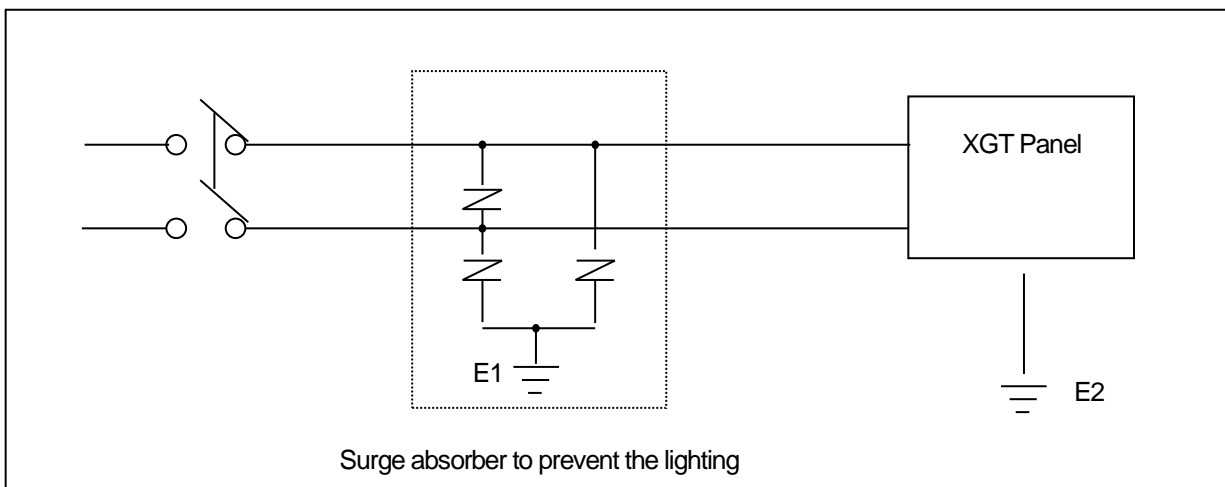

Remark

- (1) Separate E1, the ground connection for lightning surge protector, and E2, the ground connection for XGT Panel.
- (2) Set lightning surge protector to below the allowable surge voltage to provide protection if the voltage increases to its maximum.

Use an insulation shielding transformer or noise filter when the electromagnetic interference occurs. Keep the stripped ends of the terminated cables twisted and as short as possible. When running the wiring avoid running the cables for the insulation shielding transformer or noise filter pass through the cable duct.

When you use the magnetic lighting contactor (MC) for AC/DC, it is recommended to use a ferrite core close to the power terminals as shown below:

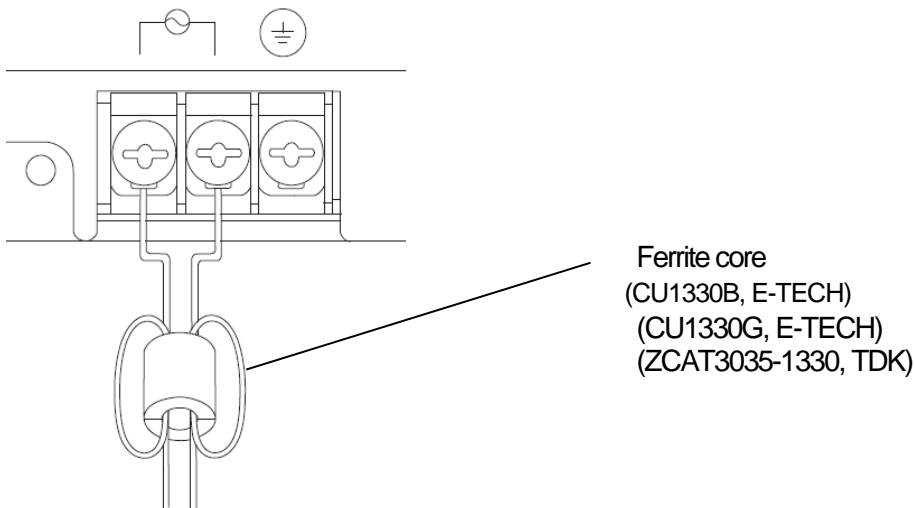

10.2.2 Ground wiring

- (1) Our XGT Panel has enough anti-noise measure, so except that there are many noises specially, the ground is not needed. When you use the ground connection, refer to the following information.
- (2) Use the exclusive ground connection. When you install the ground connection, use the third grounding resistance (less than $100\ \Omega$).
- (3) If you cannot use the exclusive ground connection, use the common ground connection like below.

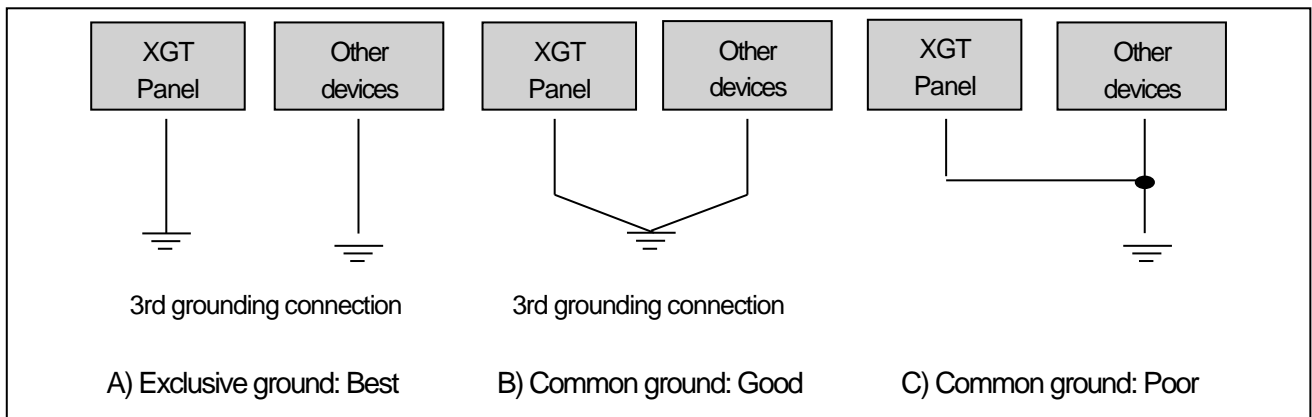

- (4) Use cables for grounding/earth connections by using cable with a cross sectional area greater than $2.0\ \text{mm}^2$. Install the ground connection as close as possible to the XGT Panel.

Remark

- (1) Check and test the grounding connection. If the connection is bad or in case of (B) above, the XGT Panel may malfunction or the communication signals may fail.

Chapter 11 Maintenance

To keep the XGT Panel best, examine the XGT Panel.

11.1 Maintenance

Because an error may be developed by environment, the periodic maintenance is needed. You should check the following categories once or twice every 6 months.

Maintenance category		Criterion	Action
Power		Within the power change range (Within -15% / +10%)	Modify the source of electric power in order to be in the fluctuation range of a permissible voltage.
Environment	Operating temperature	0 ~ +50°C	Modify the operating temperature and humidity to be proper.
	Operating humidity	10 ~ 85%RH	
	Vibration	No vibration	Use the anti-vibration rubber and make a count measure.
Getting loose of power terminal		There is no unwinding	Screw the unwound terminal.
Getting loose of communication connector		There is no unwinding	Screw the unwound terminal.
Reserved part		Amount of reserved part and reservation Check the status	Refill the insufficiency and improve the reservation.
Gasket installation status		No gap between the gasket and panel.	Replace gasket or affix brackets firmly
Gasket status		No damage or deterioration	Replace gasket

11.2 Daily Maintenance

Check the followings daily.

Maintenance category	Maintenance contents	Criterion	Action
Mounting status	Check the brackets	Should be mounted firmly	Retighten screws
Power terminal status	Loose terminal screws	Not loose	Retighten screws
	Reduce the distance between compressed terminals.	Keep the proper distance.	Correction
Communication connector status	Unwinding of fixed screw	Not loose	Retighten screws

Indication LED	Check the lighting	Green LED should be turned on	Refer to the appendix 1.
----------------	--------------------	-------------------------------	--------------------------

11.3 Periodical Maintenance

Check the followings once or twice every six months and take measure.

Maintenance category		Maintenance method	Criterion	Action
Environment	Surrounding temperature	Measure through temperature/Hygrometer Measure of corrosive gas	0 ~ 50 °C	Modify it to meet the general standard. (environment standard in the panel)
	Surrounding humidity		10 ~ 85%RH	
	Surrounding pollution degree		No corrosive gas.	
XGT Panel Status	Unwinding, swing	Move XGT Panel	Fixed firmly	Retighten screws
	Dust, foreign matter adhesion	Visual check	Not loose	-
Connection status	Looseness	Retighten screw with Screwdriver	Not loose	Retighten screws
	Reduce the distance between compressed terminals.	Visual check	Keep the proper distance.	Correction
	Loose connectors	Visual check	Not loose	Wind the fixed screw of connector
	Loose brackets	Retighten screw with Screwdriver	Not loose	Retighten screws
Power voltage maintenance		Check the power voltage of input terminal of power by test	AC: 100~240V DC: 12V-24V	Supply power modification
Battery		Check when battery is exchanged and voltage drop is indicated (It is expressed by system alarm)	<ul style="list-style-type: none"> • Check the total of power stoppage time and guarantee duration • There is no battery voltage drop indication 	If guarantee duration is exceeded even though there is no battery voltage drop indication, change the battery.
LCD Backlight maintenance		Visual check	Check the guarantee duration	When error occurs, change the backlight.
Touch status	Touch location error	Check at the Diagnostics of XGT Panel	Appropriate touch location	Reset at the setting of XGT Panel.
	Damage or deterioration of protection sheet	Visual check	There is no damage or deterioration	When error occurs, change protection sheet

Remark

- (1) Battery exchange time is expressed by alarm. System alarm is expressed when system alarm category is set at the XP-Builder as follows.

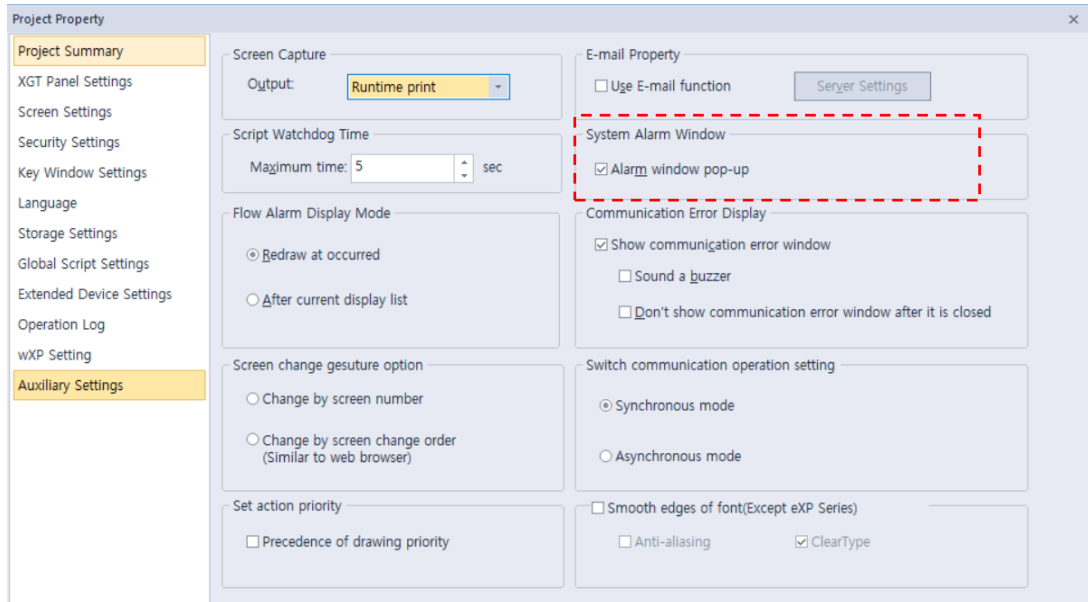

- (2) iXP model LCD backlight is not replaceable. Therefore when backlight has some problem or it is no longer of any use, LCD has to be replaced.

Chapter 12 EMC Standard Certification

12.1 Requirement for EMC Standard Certification

EMC command is regulated on “It doesn’t produce the Strong electromagnetic waves: Emission” and “It is not affected by electromagnetic wave from external: Immunity”. The following is describing the contents to meet the EMC command when configuring the system by using the XGT Panel. This is a summary document for the request and standard which our company has obtained from EMC but we don't assure that all devices manufactured according to these contents are not suitable for the below standards. The final manufacturer needs to finally judge about the fitness method or fitness judgment of EMC command.

12.1.1 CE standard certification

Applied Standards		Results
1. Emission		
Conducted Disturbance	EN61000-6-4:2007	C
Radiated Disturbance	EN61000-6-4:2007	C
Harmonic Current Emission	EN61000-3-2:2006 / A2 : 2009	NA ^{re2)} NT ^{re3)}
Voltage Change, Fluctuations and Flicker	EN61000-3-3:2008	NA ^{re2)} NT ^{re3)}
2. Immunity		
Electrostatic Discharge	EN61000-6-2:2005	C
	EN61000-4-2:2009	
Radio-Frequency Electromagnetic Field	EN61000-6-2:2005	C
	EN61000-4-3:2006 / A1 : 2008	
Fast Transient	EN61000-6-2:2005	C
	EN61000-4-4:2004	
Radio-Frequency Continuous Conducted	EN61000-6-2:2005	C
	EN61000-4-6:2009	
Power-Frequency Magnetic Fields	EN61000-6-2:2005	C
	EN61000-4-8:1993 / A1 : 2001	
Surges	EN61000-6-2:2005	C
	EN61000-4-5:2006	
Voltage Dips and Interruptions	EN61000-6-2:2005	NA ^{re2)} C ^{re3)}
	EN61000-4-11:2004	
RE1) C=Conform NC=Not Conform NT=Not Tested NA=Not Applicable RE2) Applicable to the only iXP50-TTA/DC, iXP70-TTA/DC, iXP80-TTA/DC, iXP90-TTA/DC RE3) Applicable to the only iXP70-TTA/AC, iXP80-TTA/AC, iXP90-TTA/AC		

Directive:

Electromagnetic Compatibility Directive 89/336/EEC amended by the Directive 93/68/EEC



12.1.2 KC standard certification

The XGT Panel acquire the electromagnetic fitness registration (KC specification) certified by wave laboratory under information-communication part.

A grade device

This device acquires KC for industrial use.

If device is not purchased properly, exchange it to device for home use.



12.2 Requirement for Low Voltage Command Suitability

It is required to get the needed Stability for the device operated at AC50~1000V, DC75~1500V's power. The following describes attention about installation and wiring for the suitability when using the XGT Panel. Though the following data is made by requirement of regulation and standard, we don't guarantee that all devices are suitable for the above command. The method to be suitable for the EMC command and judgment of suitability should be finally made by device manufacturer himself.

12.2.1 Standard certification for XGT Panel

XGT Panel is according to the EN61131-2:2007 (stability of device used in the measure, control laboratory). XGT Panel, iXP70-TTA /AC, iXP80-TTA /AC and iXP90-TTA /AC, is made to meet the above standard.

12.2.2 Selection of XGT Panel

(1) iXP70-TTA/AC, iXP80-TTA/AC, iXP90-TTA/AC

Because the Power module whose rated input voltage is AC100-240V has danger voltage (voltage of more than 42.4V), the product which is suitable for CE mark is having the improved insulation between internal 1 and 2.

(2) iXP50-TTA/DC, iXP70-TTA/DC, iXP80-TTA/DC, iXP90-TTA/DC

The I/O module under DC12V exceeds the range of low voltage command target.

Appendix 1 Troubleshooting

1.1 Type of Problem

It classifies problems from XGT Panel including an indicated figure, indication of the object, and problems appeared when downloading. Refer to the following chart.

Classification of problem	Description
Problem when starting	Malfunction when starting. ☞ Please refer to the 2. Problem when starting.
Problem when touching	In case that there is no reaction when touching. ☞ Please refer to the 3. Reaction problem when touching.
Display problem of figure and object.	In case that the figure or object is different from when editing. ☞ Please refer to the 4. Indication problem of figure and object.
Communication problem	In case that communication is not executed properly. ☞ Please refer to the 5. Communication problem.
Error message when executing program	In case that an error message occurs when operating the XGT Panel. ☞ Please refer to the 6. Error message when executing program.

1.2 Problem when Starting

Question	Why does black screen show up when turning on the device?
Phenomenon	When turning on the device, black screen shows up and the booting is impossible.

< Cause >

- (1) Because the device is not set as a booting mode.
- (2) Black screen may appear because of malfunction of backlight.

<Solution>

- (1) because the device is not set as a booting mode, the above problem can occur. Check whether the number 2 switch at DIP switch in the back of the device is in A direction or not.

When is the color of LED changed?
Please check the followings.

Display color	Contents
GREEN	Power is supplied to XGT Panel

1.3 Reaction Problem when Touching

Question	When touching the screen it reacts in a different area or it may not react at all?
Phenomenon	When touching the screen it reacts in a different area or it may not react at all.

< Cause >

- (1) Touch's Calibration setting is not proper.
- (2) Touch panel may be a break down.

<Solution>

- (1) Redo Calibration setting about touch. Refer to the [Device manual Ch.4.1 Touch Calibration].
- (2) If you can't go to setting menu, connect mouse to USB port and use mouse.

Question	Buzzer does not sound
Phenomenon	Phenomenon: When pressing buzzer, buzzer does not sound.

< Cause >

- (1) When that the switch operates but the buzzer doesn't sound, the buzzer is set as no sound.
- (2) If the switch doesn't work too, it seems that some error occurs in the touch function.

<Solution>

- (1) Redo environment setting for buzzer to sound. Refer to the [device manual Ch.4.7 Environment Setting].
- (2) After setting to use buzzer, check whether the buzzer sounds or not in the 1)'s setting windows.

1.4 Display Problem of Figure and Object

Question	The shape of object is not shown or the number or character value which has to be shown is not shown
Phenomenon	The shape of object is not shown or the number or character value which has to be shown is not shown.

<Cause>

(1) The connection with PLC connected with each project is disconnected or NAK occurs.

<Solution>

- (1) When the communication is executed at first, Check the cable connected with PLC is OK or not.
- (2) If object where the offset is set is not shown, check whether address range is exceeded or not.
- (3) In case that communication is not OK, when communication is abnormal, the following message shows up in the XGT Panel.

Object type	Phenomenon
Bit Switch	The switch is expressed but it doesn't work.
Word Switch	The switch is expressed but it doesn't work.
Change Screen Switch	The switch is expressed but it doesn't work.
Special Switch	The switch is expressed but it doesn't work.
Multi Switch	The switch is expressed but it doesn't work.
Bit Lamp	Image is not shown.
Word Lamp	Image is not shown.
N-State Lamp	Image is not shown.
Clock	Present time is shown.
Bit Message	Message is not shown. When designating the background image, image is shown as it is.
Word Message	Message is not shown. When designating the background image, image is shown as it is.
Numeric Display	The value is not shown. When designating the background image, image is shown as it is.
Numeric input	The value is not shown. When designating the background image, image is shown as it is.
Text Display	Character string is not shown. When designating the background image, image is shown as it is.
Text Input	Character string is not shown. When designating the background image, image is shown as it is.
Bit Window	The window screen set in the object is not shown. But if communication is set with other object in the same window screen, it can be shown by that object.
Word Window	The window screen set in the object is not shown. But if communication is set with other object in the same window screen, it can be shown by that object.
Bit Part	The part screen set in the object is not shown. But if communication is set with other object in the same part screen, it can be shown by that object.
Word Part	The part screen set in the object is not shown. But if communication is set with other object in the same part screen, it can be shown by that object.
Animation	Animation is not shown.
Bar Graph	Graph is not shown. When designating the background image, image is shown as it is.

Appendix 1. Troubleshooting

Object type	Phenomenon
Pie Graph	Graph is not shown. When designating the background image, image is shown as it is.
Meter Graph	Graph is not shown. When designating the background image, image is shown as it is.
Closed Graph	Graph is not shown. When designating the background image, image is shown as it is.
Trend Graph	X, Y axis is shown normally but trend axis is not normally shown. When designating the background image, image is shown as it is.
History Alarm Viewer	Change doesn't occur. When communication is abnormal, alarm occurs because it can't know the status of alarm target device. But previous alarm data shows up as it is.
Data list	Value is not shown. Lattice of viewing data list of object is shown as it is.
Logging Viewer	Change doesn't occur. When communication is normal, the recorded log data is shown normally. But, log data is shown as # when communication is abnormal.
Navigator	Change doesn't occur. Because it shows the group of alarm already developed, though communication is abnormal, if it has alarm data already developed, it shows the name of group where each alarm is included.

Question	The number indication object value is shown as # or ~
Phenomenon	The number indication object value is shown as # or ~. (Same phenomenon occurs at the number input device, viewing data list, and viewing logging)

<Cause>

- (1) This happens when digit is not correct or type is not BCD.

<Solution>

- (1) When the number to be expressed exceeds the number set in the object, # is expressed. In case of this, set the digit largely and after download again, execute program again.
- (2) When the numeric display object is expressed as BCD type, the data whose type is not BCD is expressed as ~. In case of this, adjust device value as BCD type.
- (3) This phenomenon occurs at the data list object, numeric input, numeric display device, and logging viewer.

Question	After switching the screen, the previous screen remains for a few minute
Phenomenon	After switching the screen, when there is no background or image in the part or number indication device, the previous screen remains for a few minute because of change of part

< Cause >

- (1) After switching the screen, when connection is set up multiply or communication time-out occurs, the screen of previous part remains in some object.

<Solution>

- (1) It is normal status. In case that multiple connection or communication is not good, when switching the screen, the remains of previous screen can occur during the time-out hour.

Question	The folded object doesn't sequentially show up
Phenomenon	The number under the data list shows up above data list

< Cause >

(1) The device value is expressed at the top of object screen.

<Solution>

(1) It is normal status. The folded window or part object is not included in screen, regardless of sequence of drawing, the object changed recently is expressed at top of screen. So if possible, do not fold the object in screen.

Question	The object always shows up above the figure
Phenomenon	I downloaded the figure above the object in XP-Builder, but the object always shows up above the figure

< Cause >

(1) In XGT Panel, The object always shows up above the figure.

<Solution>

(1) It is normal status. The object always shows up above figure in the XGT Panel.

Question	Pop up window doesn't show camera screen
Phenomenon	In the XP-Builder, the user deployed live image player on the pop up window (Nominating as global window or window object), but it doesn't show camera screen

<Cause>

(1) Camera object is displayed only through a single object on the whole screen. That is, if the image started to be displayed on window screen, the live image player on the other screen such as basic screen doesn't display any more. Live image play is also displayed through an object only. Likewise, if the image is being played, the other live image player object doesn't play.

<Solution>

(1) Please touch the special switch for pause among those connected with the object of live image player now under play, and then start playing by pushing the special switch for start placed on the desired screen.

1.5 Communication Problem

Question	It seems that communication does not work
Phenomenon	On the screen where the object is not many, communication works but when you move the screen where the object is many, timeout occurs

< Cause >

- (1) In the device setting, the communication time-out is set to be too short.

<Solution>

- (1) It occurs because timeout is set much smaller than sum of request time of communication data and response time from PLC. In the device setting at the XP-Builder, after setting communication time out to be big, download program and execute again.

Question	It seems that communication doesn't work
Phenomenon	Communication doesn't work

< Cause >

- (1) Communication setting or cable may be not normal.

<Solution>

- (1) In case of RS-232C, check whether connection setting is normal or not in XP-Builder.
- (2) In case of RS-422/485, check whether station and communication connection setting is normal or not.
- (3) If 1), 2) is normal, do diagnosis about PLC-RS232C, PLC-RS485/422 at the Serial diagnosis screen of device menu. Refer to the [Device manual ch.5.6 Serial Communication Diagnosis]
- (4) If 3) is normal, check whether connection cable has error or not.
- (5) In case of Ethernet, check the port and IP setting about relative PLC.



Caution

- ▶ Before trial operation of the product, be sure to check if a normal communication is available between XGT Panel and the subject device of control

1.6 SD/USB Removal of Memory Card

Question	When removing the SD/USB memory card, device is stopped for some times
Phenomenon	This happens when doing data backup including logging, recipe

< Cause >

(1) This happens because memory card is removed when doing data backup.

<Solution>

- (1) If possible, when monitoring XGT Panel, do not remove the memory card and after going out to the waiting screen, execute the removing.
- (2) Inescapably you have to remove it during the operation, remove when backup does not occur. If the above phenomenon occurs, it works normally after about 10 seconds.
- (3) In case of USB memory, please remove it when the LED of USB external memory is not flickering.
- (4) In case of SD memory cards, please remove it if LED is Off after the safety removal switch is turned On.

Question	When removing the SD memory card from XGT Panel(iXP), It is not pulled out normally.
Phenomenon	This happens when removing SD card from XGT Panel(iXP)

< Cause >

(1) The SD card connector in XGT Panel has one way spring(not both way)

<Solution>

(1) If SD card is not normally pulled out from XGT Panel, push the bottom of SD card strongly.(Spring side)

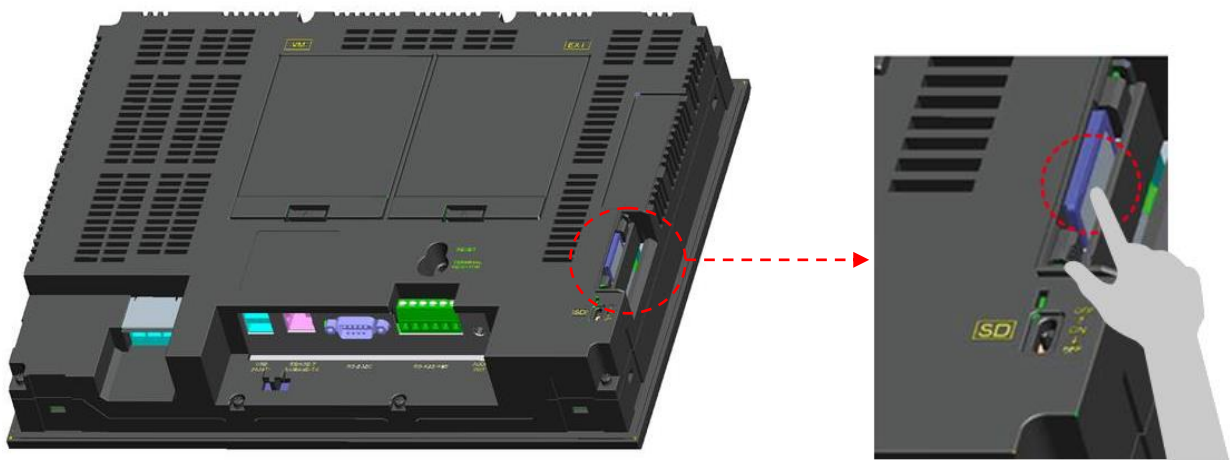

(2) If (1) does not work, remove it to use home on SD card.

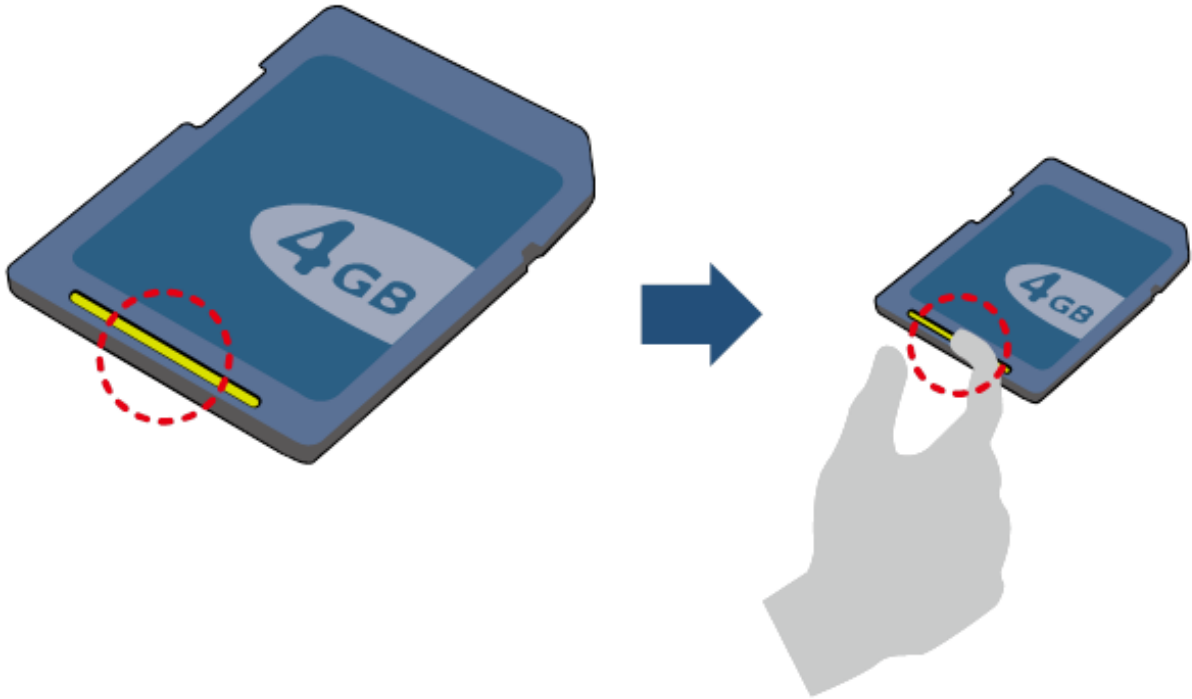

Caution

- ▶ If you force to remove the data during the storage of data in the external memory, file may not be stored in a normal condition or external memory may suffer from damage.

Appendix 2. Dimension (Unit: mm)

(1) iXP50-TT/DC

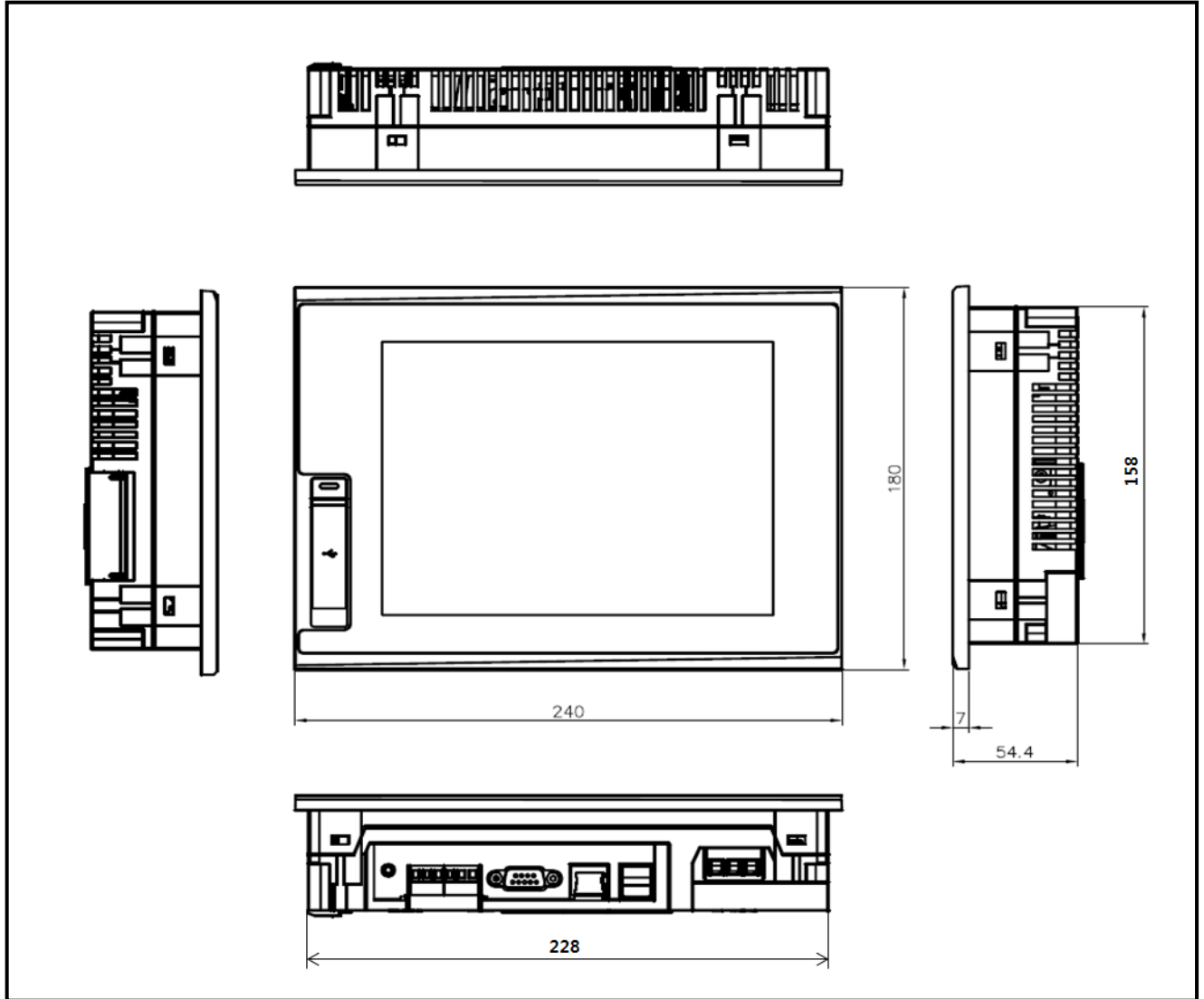

(2) iXP70-TTA/AC (DC)

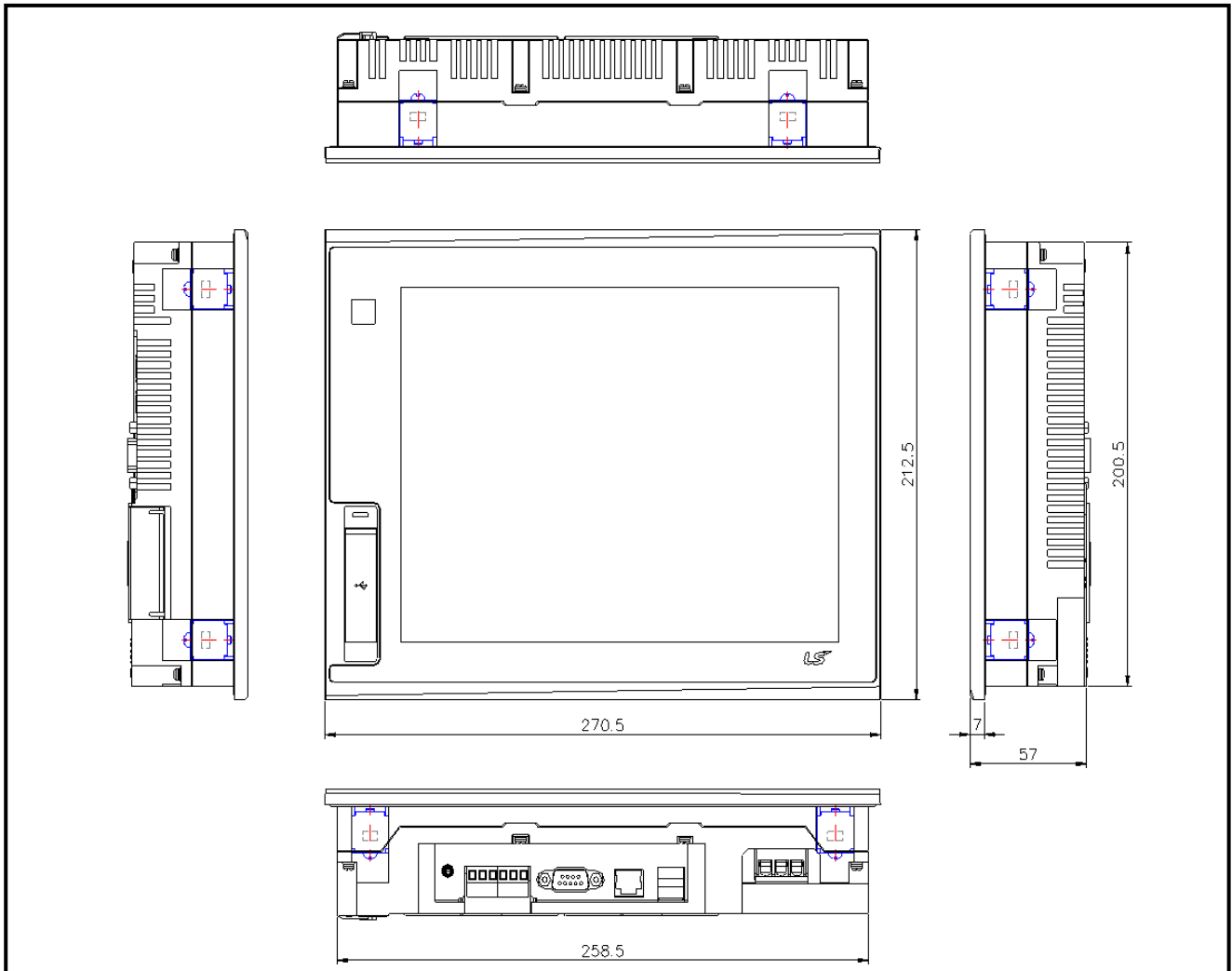

Appendix 2. Dimension

(3) iXP80-TTA/AC (DC)

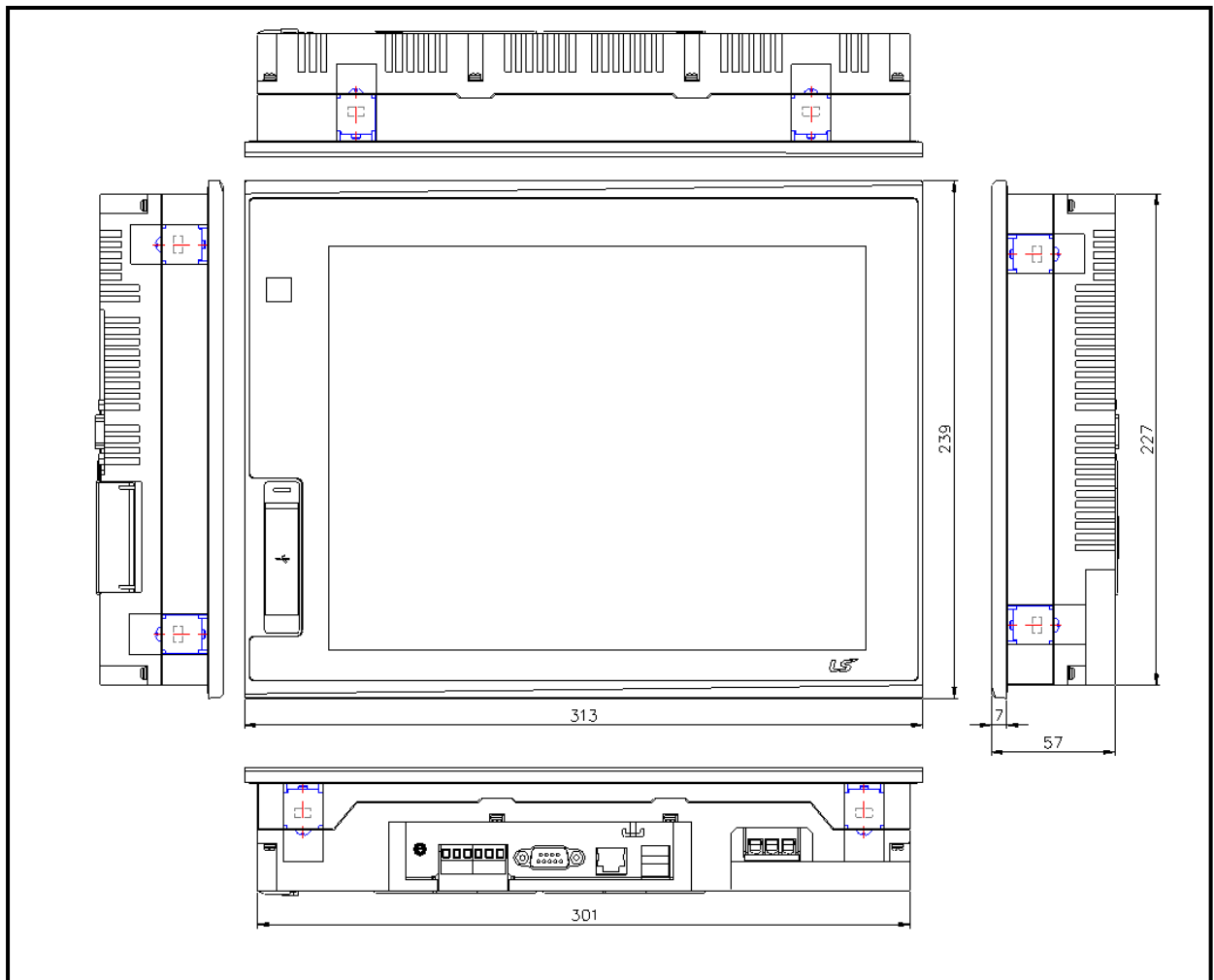

(4) iXP90-TTA/AC (DC)

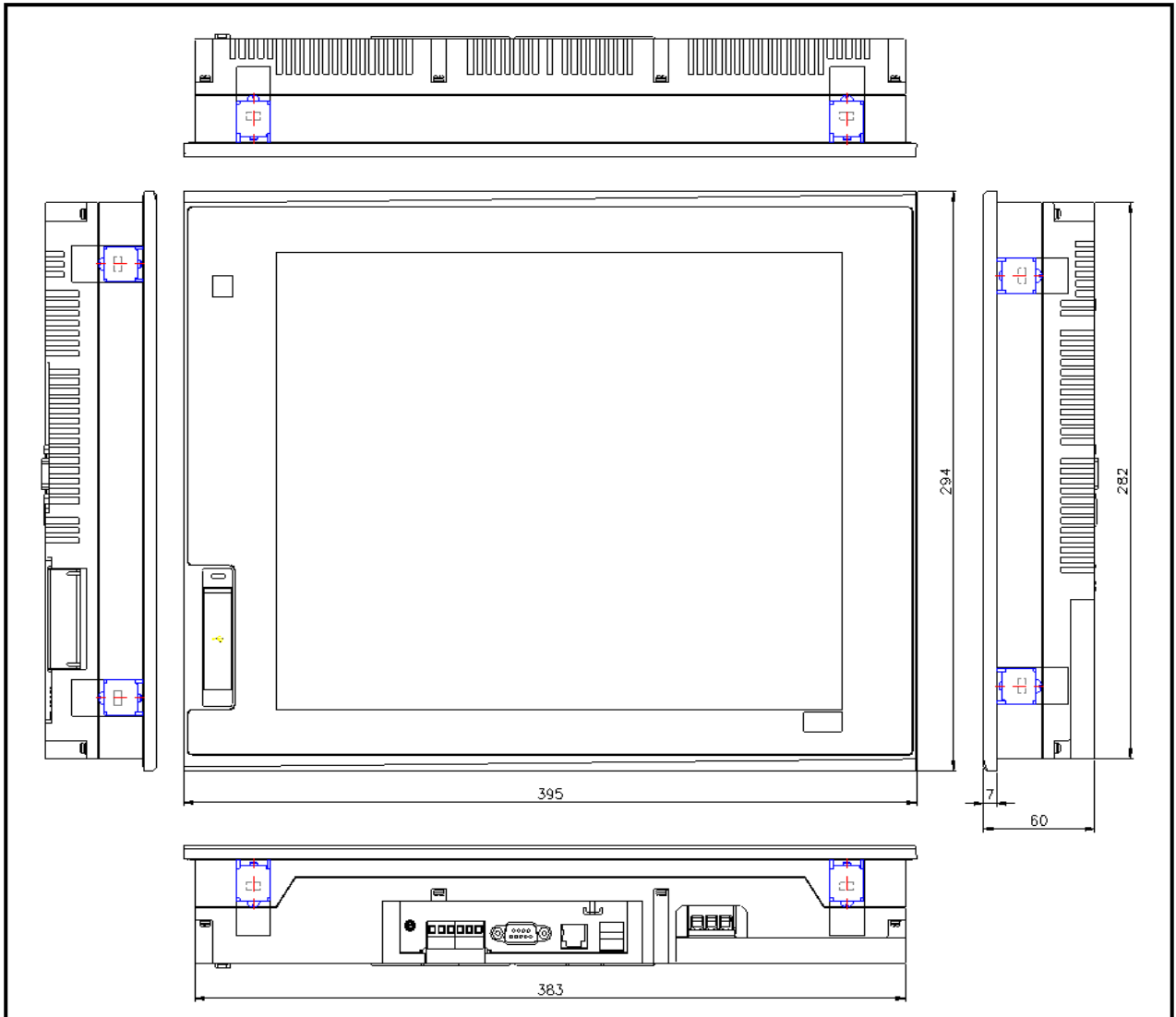

Warranty

1. Warranty Period

The product you purchased will be guaranteed for 18 months from the date of manufacturing.

2. Scope of Warranty

Any trouble or defect occurring for the above-mentioned period will be partially replaced or repaired. However, please note the following cases will be excluded from the scope of warranty.

Any trouble attributable to unreasonable condition, environment or handling otherwise specified in the manual,

Any trouble attributable to others' products,

If the product is modified or repaired in any other place not designated by the company,

Due to unintended purposes

Owing to the reasons unexpected at the level of the contemporary science and technology when delivered.

Not attributable to the company; for instance, natural disasters or fire

3. Since the above warranty is limited to HMI unit only, make sure to use the product considering the safety for system configuration or applications.

Environmental Policy

LS ELECTRIC Co., Ltd supports and observes the environmental policy as below.

Environmental Management

LS ELECTRIC considers the environmental preservation as the preferential management subject and every staff of LS ELECTRIC use the reasonable endeavors for the pleasurable environmental preservation of the earth.

About Disposal

LS ELECTRIC PLC unit is designed to protect the environment. For the disposal, separate aluminum, iron and synthetic resin (cover) from the product as they are reusable.



www.lselectric.co.kr

LS ELECTRIC Co., Ltd.

■ Headquarter

LS-ro 127(Hogye-dong) Dongan-gu, Anyang-si, Gyeonggi-Do, 14119, Korea

■ Seoul Office

LS Yongsan Tower, 92, Hangang-daero, Yongsan-gu, Seoul, 04386, Korea
Tel: 82-2-2034-4033, 4888, 4703 Fax: 82-2-2034-4588
E-mail: automation@lselectric.co.kr

■ Factory

56, Samseong 4-gil, Mokcheon-eup, Dongnam-gu, Cheonan-si, Chungcheongnam-do, 31226, Korea

■ Overseas Subsidiaries

- **LS ELECTRIC Japan Co., Ltd. (Tokyo, Japan)**
Tel: 81-3-6268-8241 E-Mail: jschuna@lselectric.biz
- **LS ELECTRIC (Dalian) Co., Ltd. (Dalian, China)**
Tel: 86-411-8730-6495 E-Mail: jiheo@lselectric.com.cn
- **LS ELECTRIC (Wuxi) Co., Ltd. (Wuxi, China)**
Tel: 86-510-6851-6666 E-Mail: sblee@lselectric.co.kr
- **LS ELECTRIC Shanghai Office (China)**
Tel: 86-21-5237-9977 E-Mail: tsjun@lselectric.com.cn
- **LS ELECTRIC Vietnam Co., Ltd.**
Tel: 84-93-631-4099 E-Mail: jhchoi4@lselectric.biz (Hanoi)
Tel: 84-28-3823-7890 E-Mail: sjbaik@lselectric.biz (Hochiminh)
- **LS ELECTRIC Middle East FZE (Dubai, U.A.E.)**
Tel: 971-4-886-5360 E-Mail: salesme@lselectric.biz
- **LS ELECTRIC Europe B.V. (Hoofddorf, Netherlands)**
Tel: 31-20-654-1424 E-Mail: europartner@lselectric.biz
- **LS ELECTRIC America Inc. (Chicago, USA)**
Tel: 1-800-891-2941 E-Mail: sales.us@lselectricamerica.com

LS ELECTRIC



Technical Question or After-sales Service
Customer Center - Quick Responsive Service, Excellent technical support
TEL. 82-1644-5481 | www.lselectric.co.kr

Specifications in this instruction manual are subject to change without notice due to continuous products development and improvement.