

The right choice for the ultimate yield!

LS ELECTRIC strives to maximize your profits in gratitude for choosing us as your partner.

Programmable Logic Control

XGB Main unit (XEC-U Type)

XGT Series

User Manual

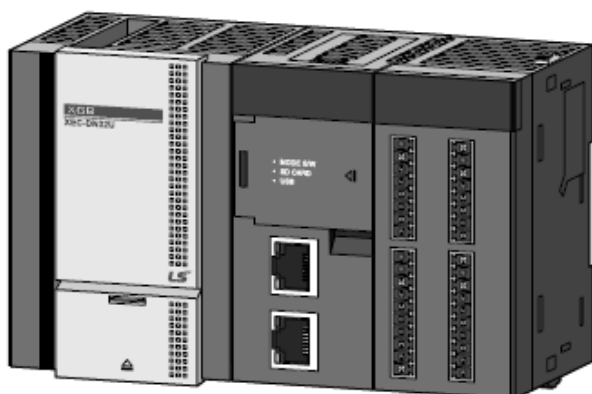

XEC-DN32U(/DC)
XEC-DN32UP(/DC)
XEC-DN32UA(/DC)
XEC-DP32U(/DC)
XEC-DP32UP(/DC)
XEC-DP32UA(/DC)
XEC-DR28U(/DC)
XEC-DR28UP(/DC)
XEC-DR28UA(/DC)

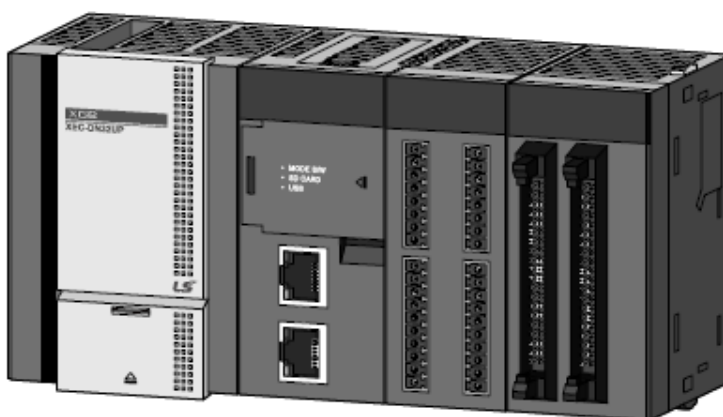

Safety Instructions

- Read this manual carefully before installing, wiring, operating, servicing or inspecting this equipment.
- Keep this manual within easy reach for quick reference.

LSELECTRIC

Before using the product ...

For your safety and effective operation, please read the safety instructions thoroughly before using the product.



- ▶ Safety Instructions should always be observed in order to prevent accident or risk with the safe and proper use the product.
- ▶ Instructions are separated into “Warning” and “Caution”, and the meaning of the terms is as follows;



Indicates a potentially hazardous situation which, if not avoided, could result in death or serious injury



Indicates a potentially hazardous situation which, if not avoided, may result in minor or moderate injury. It may also be used to alert against unsafe practices

- ▶ The marks displayed on the product and in the user’s manual have the following meanings.
 -  Be careful! Danger may be expected.
 -  Be careful! Electric shock may occur.
- ▶ The user’s manual even after read shall be kept available and accessible to any user of the product.

Safety Instructions when designing

Warning

- ▶ **Please, install protection circuit on the exterior of PLC to protect the whole control system from any error in external power or PLC module.** Any abnormal output or operation may cause serious problem in safety of the whole system.
 - Install applicable protection unit on the exterior of PLC to protect the system from physical damage such as emergent stop switch, protection circuit, the upper/lowest limit switch, forward/reverse operation interlock circuit, etc.
 - If any system error (watch-dog timer error, module installation error, etc.) is detected during CPU operation in PLC, the whole output is designed to be turned off and stopped for system safety. However, in case CPU error if caused on output device itself such as relay or TR can not be detected, the output may be kept on, which may cause serious problems. Thus, you are recommended to install an addition circuit to monitor the output status.

- ▶ **Never connect the overload than rated to the output module nor allow the output circuit to have a short circuit,** which may cause a fire.

- ▶ **Never let the external power of the output circuit be designed to be On earlier than PLC power,** which may cause abnormal output or operation.

- ▶ **In case of data exchange between computer or other external equipment and PLC through communication or any operation of PLC (e.g. operation mode change), please install interlock in the sequence program to protect the system from any error.** If not, it may cause abnormal output or operation.

Safety Instructions when designing

Caution

- ▶ **I/O signal or communication line shall be wired at least 100mm away from a high-voltage cable or power line.** If not, it may cause abnormal output or operation.

Safety Instructions when designing

Caution

- ▶ **Use PLC only in the environment specified in PLC manual or general standard of data sheet.** If not, electric shock, fire, abnormal operation of the product or flames may be caused.
- ▶ **Before installing the module, be sure PLC power is off.** If not, electric shock or damage on the product may be caused.
- ▶ **Be sure that each module of PLC is correctly secured.** If the product is installed loosely or incorrectly, abnormal operation, error or dropping may be caused.
- ▶ **Be sure that I/O or extension connector is correctly secured.** If not, electric shock, fire or abnormal operation may be caused.
- ▶ **If lots of vibration is expected in the installation environment, don't let PLC directly vibrated.** Electric shock, fire or abnormal operation may be caused.
- ▶ **Don't let any metallic foreign materials inside the product,** which may cause electric shock, fire or abnormal operation..

Safety Instructions when wiring

Warning

- ▶ **Prior to wiring, be sure that power of PLC and external power is turned off.** If not, electric shock or damage on the product may be caused.
- ▶ **Before PLC system is powered on, be sure that all the covers of the terminal are securely closed.** If not, electric shock may be caused

Caution

- ▶ **Let the wiring installed correctly after checking the voltage rated of each product and the arrangement of terminals.** If not, fire, electric shock or abnormal operation may be caused.
- ▶ **Secure the screws of terminals tightly with specified torque when wiring.** If the screws of terminals get loose, short circuit, fire or abnormal operation may be caused.
- *
 - ▶ **Surely use the ground wire of Class 3 for FG terminals, which is exclusively used for PLC.** If the terminals not grounded correctly, abnormal operation may be caused.
 - ▶ **Don't let any foreign materials such as wiring waste inside the module while wiring,** which may cause fire, damage on the product or abnormal operation.

Safety Instructions for test-operation or repair

Warning

- ▶ **Don't touch the terminal when powered.** Electric shock or abnormal operation may occur.
- ▶ **Prior to cleaning or tightening the terminal screws, let all the external power off including PLC power.** If not, electric shock or abnormal operation may occur.
- ▶ **Don't let the battery recharged, disassembled, heated, short or soldered.** Heat, explosion or ignition may cause injuries or fire.

Caution

- ▶ **Don't remove PCB from the module case nor remodel the module.** Fire, electric shock or abnormal operation may occur.
- ▶ **Prior to installing or disassembling the module, let all the external power off including PLC power.** If not, electric shock or abnormal operation may occur.
- ▶ **Keep any wireless installations or cell phone at least 30cm away from PLC.** If not, abnormal operation may be caused.

Safety Instructions for waste disposal

Caution

- ▶ **Product or battery waste shall be processed as industrial waste.** The waste may discharge toxic materials or explode itself.

Revision History

Version	Date	Remark	Part	Page
V 1.0	2015.5	1. First Edition	-	-
		1.source output PLC added(XEC-DPxxU(A)(P))	0	Front
			2	2-1~4,3-6
		2.DC power PLC added(/DC)	0	Front
			1	3-5
		3.PID bumpless added		-
		- _PID_MV_BMPL flag comment modified	2	6-20
		4.Web server download modified		-
V1.1	2015.7	-2) communication setup	5	3-20~21
		-3.5 Improvement of the web server's speed	5	3-69~71
		5.Internal Input/output circuit & TB modified	2	3-5~7
		6.deviac&flag modified		
		(1) web server flag added	5	3-11
		(2) Timer flag added	App	App 1-2
		(3) N Device Notice modified(cannot write)	App	App 1-10
		1. user CAM modified	3	8-125
		- When the User CAM is operating, changing User CAM is available in continuous operation		
		2. Module added	2	2-1,3
		- XBE-DN32A		
V1.2	2017.7	3. PWM output err added(2ms)	2	6-12
		4. High speed counter clear function added	2	4-21
		5. Add OS update function using SD card	App	App 5-1
		6. Built-in FENet 16 channel function added	5	1-3~4, 15
		7. Added auto assignment function	1	3-10
		8. Add smart server function	5	1-36
		9. Add PLC uptime flag	App	App 1-5

Revision History

		10. Add PID differential calculation source parameter	2	6-19
V1.3	2020.6	1. Company name changed	-	-
V1.4	2021.9	1. Modify partner port range	5	1-49
V1.5	2022.6	1. Instructions for System Configuration changed	1	2-8
V1.6	2022.9	1. Change domain (lselectric.co.kr -> ls-electric.com)		
V1.7	2022.10	Minimum distance specification between nodes added	5	1-3

About User's Manual

Congratulations on purchasing PLC of LS ELECTRIC Co.,Ltd.

Before use, make sure to carefully read and understand the User's Manual about the functions, performances, installation and programming of the product you purchased in order for correct use and importantly, let the end user and maintenance administrator to be provided with the User's Manual.

The User's Manual describes the product. If necessary, you may refer to the following description and order accordingly. In addition, you may connect our website(<http://www.ls-electric.com/>) and download the information as a PDF file.

Relevant User's Manual

Title	Description	No. of User Manual
XG5000 User's Manual	It describes how to use XG5000 software especially about online functions such as programming, printing, monitoring and debugging by using XGT series products.	10310000512
XGK/XGB Series Instruction & Programming	It describes how to use the instructions for programming using XGK/XGB series.	10310000510
XBC Ultimate Performance XGB Unit	It describes how to use XGB main unit, system configuration, mechanism, program function, input/output function, Built-in High-speed Counter, Datalog, PID Control, Built-in Communication function, Built-in Position, Built-in Analog input/output..	10310001374
XGB Analog User's Manual	It describes how to use the specification of analog input/analog output/temperature input module, system configuration and built-in PID control for XGB main unit.	10310000920
XGB Position User's Manual	It describes how to use built-in Position function for XGB main unit.	10310000927
XGB Cnet I/F User's Manual	It describes how to use built-in communication function for XGB main unit and external Cnet I/F module.	10310000816
XGB Fast Ethernet I/F User's Manual	It describes how to use XGB FENet I/F module.	10310000873
CANopen Communication Module	It describes how to use XGB CANopen Communication Module	0310001245
EtherNet/IP Communication Module	It describes how to use XGB EtherNet/IP Communication module	10310001159

About User's Manual

XGB Profibus-DP I/F (Master) User's Manual	It describes how to use XGB Profibus-DP I/F (Master) Communication Module	10310001310
XGB Profibus-DP I/F (Slave) User's Manual	It describes how to use XGB Profibus-DP I/F (Slave) Communication Module	10310001410
XGB DeviceNet I/F (Slave) User's Manual	It describes how to use XGB DeviceNet I/F (Slave) Communication Module	10310001414
XGB High speed counter module User's Manual	It describes how to use High speed counter(XBF-HO02A, XBF-HD02A)	10310001240

© Contents ©

Part1. System

Chapter 1 Introduction	1-1~1-18
1.1 Guide to Use This Manual.....	1-1
1.2 Features	1-3
1.3 Terminology.....	1-5
 Chapter 2 System configuration	 2-1~2-12
2.1 Table of Products Configuration	2-1
2.2 Classification and Type of Product Name	2-3
2.3 High performance XGB's System Configuration.....	2-7
 Chapter 3 Specifications.....	 3-1~3-14
3.1 Names and Functions of Each Part	3-1
3.2 General Specifications	3-4
3.3 Power Specifications	3-5
3.4 Battery	3-7
3.5 Performance specifications	3-10
 Chapter 4 Installation and wiring	 4-1~4-18
4.1 Parameter & Operation data	4-1
4.2 Attachment/Detachment of Modules	4-7
4.3 Wire	4-12
 Chapter 5 Maintenance	 5-1~5-2
5.1 Maintenance and Inspection	5-1
5.2 Daily Inspection	5-2
5.3 Periodic Inspection.....	5-2
 Chapter 6 Trouble Shooting	 6-1~6-14
6.1 Basic Procedure of Troubleshooting	6-1
6.2 Troubleshooting.....	6-1
6.3 Troubleshooting Questionnaire	6-7

6.4 Troubleshooting Examples.....	6-8
6.5 Error Code List	6-12
Chapter 7 EMC Standard	7-1~7-4
7.1 Requirements for Conformance to EMC Directive.....	7-1
7.2 Requirement to Conform to the Low-voltage Directive	7-4

Part2. Basic Functions

Chapter 1 Program Configuration and Operation Method	1-1~1-30
1.1 Programming Basics	1-1
1.2 Operation mode.....	1-24
1.3 Memory	1-27
Chapter 2 CPU Function	2-1~2-30
2.1 Type Setting	2-1
2.2 Parameter Setting	2-2
2.3 Self-Diagnosis Function	2-5
2.4 RTC Function	2-12
2.5 Remote Functions	2-14
2.6 I/O forced On/Off Functions	2-15
2.7 Direct I/O Operation Function	2-16
2.8 Function saving the operation history	2-18
2.9 How to allocate I/O No.	2-19
2.10 Program Modification during operation (Modification during RUN)	2-20
2.11 Read I/O information.	2-23
2.12 Monitoring Functions.....	2-24
2.13 Function to delete all of the PLC	2-29
Chapter 3 Input/Output Specifications.....	3-1~3-30
3.1 Introduction.....	3-1
3.2 Main Unit Digital Input Specifications	3-8
3.3 Main Unit Digital Output Specifications	3-9
3.4 Digital Input Specifications	3-12
3.5 Digital Output Specifications	3-15

3.6 Combined Digital I/O module Input Specification	3-24
3.7 Combined Digital I/O module Output Specification	3-25
3.8 I/O modules' Functions.....	3-26
Chapter 4 Built-in High-speed Counter Function	4-1~4-30
4.1 High-speed Counter Specifications	4-1
4.2 Installation and Wiring	4-22
4.3 Internal Memory	4-23
4.4 Example of Using High-speed Counter.....	4-27
Chapter 5 Data Log Function	5-1~5-98
5.1 Overview	5-1
5.2 Performance Specifications.....	5-6
5.3 Specific Functions	5-7
5.4 Regular Save.....	5-27
5.5 Trigger Save	5-33
5.6 Event Save	5-54
5.7 Additional Functions	5-76
5.8 CSV File Structure.....	5-82
5.9 SD Memory Card.....	5-84
5.10 Flag List.....	5-90
5.11 Data Processing Time	5-94
Chapter 6 Built-in PID Function	6-1~6-50
6.1 Features of Built-in PID Function	6-1
6.2 Basic Theory of PID Control.....	6-2
6.3 Functional Specifications of PID Control	6-9
6.4 Usage of PID Control Functions.....	6-10
6.5 PID Instructions	6-26
6.6 PID Auto-tuning	6-28
6.7 Example Programs.....	6-37
6.8 Error / Warning Codes.....	6-48

Part3. Embedded Positioning

Chapter 1 Overview.....	1-1~1-12
-------------------------	----------

Table of Content

1.1 Characteristics.....	1-1
1.2 Purpose of Positioning Control.....	1-3
1.3 Signal Flow of Embedded Positioning	1-4
1.4 Function overview of embedded positioning.....	1-5
Chapter 2 Specifications.....	2-1~2-8
2.1 Characteristics.....	2-1
2.2 External Interface I/O Specifications	2-3
2.3 The Name of Each Part.....	2-8
Chapter 3 Operation Order and Installation	3-1~3-20
3.1 Operation Order.....	3-1
3.2 Installation	3-2
3.3 Notices in Wiring	3-3
Chapter 4 Positioning Parameter & Operation Data	4-1~4-34
4.1 Parameter & Operation data	4-1
4.2 Basic Parameter.....	4-2
4.3 Extended Parameter	4-7
4.4 Manual Operation Parameter.....	4-19
4.5 Homing Parameter	4-20
4.6 I/O Signal Parameter.....	4-24
4.7 Common Parameter.....	4-25
4.8 Operation Data	4-29
Chapter 5 Internal Memory and I/O Signal.....	5-1~5-12
5.1 Internal Memory.....	5-1
5.2 I/O Signal.....	5-9
Chapter 6 Function block	6-1~6-60
6.1 Common items of function blocks	6-1
6.2 Positioning module function block.....	6-3
6.3 Function blocks related to reading module information	6-5
6.4 Function blocks related to parameters/changing operating data	6-9
6.5 Function blocks related to Start-up and Stop	6-25

6.6 Function blocks related to manual operation	6-34
6.7 Function blocks related to synchronous operation.....	6-37
6.8 Function blocks related to changes.....	6-42
6.9 Function blocks related to errors	6-54
6.10 Function blocks related to errors	6-56
6.11 Function blocks related to Servo Drive.....	6-58
 Chapter 7 Program	 7-1~7-50
7.1 Example of Programming	7-1
 Chapter 8 Functions	 8-1~8-160
8.1 Homing	8-1
8.2 Positioning Control.....	8-11
8.3 Manual Operation Control.....	8-99
8.4 Synchronous Control.....	8-106
8.5 Modification Function of Control	8-125
8.6 Auxiliary Function of Control.....	8-143
8.7 Data Modification Function.....	8-149
 Chapter 9 Positioning Error Information & Solutions.....	 9-1~9-16
9.1 Positioning Error Information & Solutions	9-1
 Chapter 10 Internal Memory Address of “Read/Write Variable Data” command	 10-1~10-92
10.1 Parameter memory address	10-1
10.2 Axis 1 operation data memory address.....	10-5
10.3 Axis 2 operation data memory address.....	10-14
10.4 Axis 3 operation data memory address.....	10-23
10.5 Axis 4 operation data memory address.....	10-32
10.6 CAM data memory address.....	10-41
10.7 User CAM data memory address.....	10-91

Part4. Embedded Analog

Chapter 1. Embedded Analog Function	1-1~1-58
1.1 Setting Sequence before Operation	1-1

1.2 Name of Each Part and Functions	1-4
1.3 Characteristic of I/O Conversion	1-5
1.4 Accuracy	1-11
1.5 Embedded Functions	1-13
1.6 Wiring	1-24
1.7 Operation Parameter Setting	1-28
1.8 Special Module Monitoring Functions.....	1-31
1.9 Register U Devices	1-36
1.10 Configuration and Function of Internal Memory.....	1-41
1.11 Example Program	1-54
1.12 Troubleshooting.....	1-56

Part 5 Built-in communication functions

Chapter.1 Built-in FEnet communication	1-1~1-124
1.1 Outline	1-1
1.2 Specifications	1-3
1.3 Specifications of installation and a trial run	1-9
1.4 Configuration of FEnet communication system	1-13
1.5 Protocols for each service	1-15
1.6 Dedicated services	1-32
1.7 P2P service.....	1-39
1.8 High speed link.....	1-68
1.9 Remote communication.....	1-80
1.10 File Transfer Protocol (FTP)	1-84
1.11 E-mail Transfer(SMTP)	1-101
1.12 Time synchronization(SNTP).....	1-116
1.13 Troubleshooting	1-122
Chapter 2 Built-in Cnet Communication	2-1~2-128
2.1 General.....	2-1
2.2 Specification	2-2
2.3 Cnet Communication System Configuration	2-10
2.4 Basic Setting for Communication	2-18
2.5 Server Function and P2P service.....	2-25
2.6 XGT Dedicated Protocol	2-49

2.7 LS Bus Protocol.....	2-69
2.8 Modbus Protocol.....	2-75
2.9 Diagnosis Function	2-89
2.10 Example Program	2-98
2.11 Error Code.....	2-123
 Chapter 3 Web Server.....	 3-1~3-78
3.1 Outline of the Web Server	3-1
3.2 Specification	3-4
3.3 How to use the web server.....	3-7
3.4 Functions of the web server	3-14
3.5 Improvement of the web server's speed	3-74
3.6 Directions for use of the web server.....	3-77

Part 6 Appendix

Appendix 1 Flag list	App1-1~10
Appendix 1.1 Special Relay (F) List	App 1-1
Appendix 1.2 Communication Relay (L) List.....	App 1-2
 Appendix 2 Dimension (Unit : mm).....	 App2-1~6
 Appendix 3 Instruction List	 App3-1~16
Appendix 3.1 Basic Function.....	App 3-1
Appendix 3.2 MK(MASTER-K) Function	App 3-11
Appendix 3.3 Array Operation Function	App 3-11
Appendix 3.4 Basic Function Block.....	App 3-12
Appendix 3.5 Expanded Function	App 3-15
 Appendix 4 How to make the user page	 App4-1~58
Appendix 4.1 Device monitoring parameter	App 4-1
Appendix 4.2 Individual exercise related to the user page	App 4-7
Appendix 4.3 Integrated exercise for the user page : Temperature control system..	App 4-45
 Appendix 5 Appendix 5 PLC update using SD.....	 App5-1~8
Appendix 5.1 Overview	App 5-1

Table of Content

Appendix 5.2 Specifications App 5-3
Appendix 5.3 Appendix 5.3 Operating Specifications App 5-4

Part 1. System

Chapter 1 Introduction

1.1 Guide to this Manual

This manual includes specifications, functions and handling instructions for XGB series PLC. This manual is divided up into chapters as follows

	No.	Title	Contents
1.system	Chapter 1	Introduction	Describes configuration of this manual, unit's features and terminology.
	Chapter 2	System Configurations	Describes available units and system configuration in the XGB series.
	Chapter 3	Specifications	Describes general specifications of units used in the XGB series.
	Chapter 4	CPU Specifications	Describes performances, specifications and operations.
	Chapter 5	Maintenance	Describes the check items and method for long-term normal operation of the PLC system.
	Chapter 6	Troubleshooting	Describes various operation errors and corrective actions.
	Chapter 7	EMC Specifications	Describes system configuration following EMC specification.
2.Main	Chapter 1	Program Configuration and Operation Method	Describes performances, specifications and operations.
	Chapter 2	CPU Specifications	
	Chapter 3	Input/Output Specifications	Describes operation of basic and input/output.
	Chapter 4	Built-in High-speed Counter Function	Describes built-in high-speed counter functions.
	Chapter 5	Datalog Function	Describes Datalog Function

	Chapter 6	Built-in PID Function	Describes Built-in PID Function
3.Positioning	Chapter 1	Overview	Describes the specification, method to use each positioning function, programming and the wiring with external equipment of embedded positioning function.
	Chapter 2	Specifications	Describes general specifications of Positioning function.
	Chapter 3	Operation Order and Installation	Describes the Operation order in case of positioning operation by embedded positioning.
	Chapter 4	Positioning Parameter & Operation Data	Describes parameter and operation data to be set by software package with embedded positioning.
	Chapter 5	Internal Memory and IO Signal	Describes the internal memory used for positioning module if XGB Main unit
4.Analog	Chapter 1	Embedded Analog	Describes the Built-in Analog Function used in XGB PLC.
5.Communication	Chapter 1	Built-in FNet Communication	Describes the Built-in FNet Communication used in XGB PLC.
	Chapter 2	Built-in Cnet Communication	Describes the Built-in Cnet Communication used in XGB PLC.
6.Appendix	Appendix 1	Flag List	Describes the types and contents of various flags.
	Appendix 2	Dimension	Shows dimensions of the main units and expansion modules.
	Appendix 3	Instruction List	Describes the special relay and instruction list.

1.2 Features

The high performance XGB basic unit has the following characteristics.

1.2.1 Advanced Performances

(1) Rapid Processing Speed

The processing speed has been improved up to more than 30% compared to the existing XGB PLC.

Items	XBC 'SU' Type	XBC 'H' Type	XBC 'U' Type	Remarks
Sequence command	94 ns	84 ns	60 ns	Based on MLOAD command
Data command	2.1 μ s	1.54 μ s	1.58 μ s	Based on MOV command
Real	4.99 μ s	4.85 μ s	3.8 μ s	RADD command
	4.5 μ s	4.64 μ s	3.8 μ s	RMUL command
Long Real	8.5 μ s	8.18 μ s	5.9 μ s	LADD command
	8.0 μ s	9.62 μ s	6.0 μ s	LMUL command

(2) Advanced embedded functions

Various and special communication functions that the existing XGB could not provide are embedded.

- Embedded Data logging function through the SD memory
- Embedded Fast Ethernet supporting the switching function
- Embedded 4-axis positioning function supporting CAM operation, multi-axis interpolation(XEC-DN32UP/DR28UP)
- Embedded analog I/O 8 channels with 14bit resolution (XEC-DN32UA/DR28UA)

1.2.2 Flexibility of System Configuration

(1) The small and medium-sized system can be established, which controls up to 352 points I/O through 10-stage expansion.

(2) Compact size

Compared to the existing XGB basic unit, this product has various embedded functions to enhance functionality and has a reduced size so you can install it even in a small space. (Unit : mm)

Type	Model	Size (W * H * D)	Remarks
Basic unit	XEC-DN32U/ DP32U/DR28U	150 * 90 * 64	Same size as to DC power PLC
	XEC-DN32UP/DP32UP/DR28UP	185 * 90 * 64	
	XEC-DN32UA/DP32UA/DR28UA	185 * 90 * 64	
Expansion module	XBE-,XBF-,XBL-	20 * 90 * 60	Based on the minimum size

(3) Securing compatibility of the existing expansion/special/communication module

All types of the existing XGB expansion/special/communication modules are available.

(4) Expanding the applications through various expansion modules

- It provides 8 points, 16 points, 32 points module I/O expansion module (In the case of relay output, 8/16 points module) with single input, single output, mixed I/O module.
- It supports various special modules such as positioning, high-speed counter, analog I/O, temperature input, temperature control.
- It provides various communication I/F modules such as Cnet, FEnet, RAPIEnet, CANOpen, Profibus-DP, DeviceNet.

1.2.3 Powerful Embedded Functions

- (1) Embedded high-speed counter function
 - The high-speed counter with up to 100kpps 8 channels(based on 1 phase 1 input 1 multiplication) is embedded.
 - Various additional functions such as comparative readout, comparative task, frequency measurement, revolutions per hour, etc. are provided.
 - Parameter setting using XG5000, various monitoring and diagnosis functions are provided.
 - You can conduct a trial run through XG5000's monitoring without the program so you can easily check of abnormalities of external wirings and data setting.
- (2) Embedded data log function
 - The data log function that can use the SD memory card of up to 6GB is embedded.
 - You can save various device data of the PLC for a long time with only parameter setting using XG5000.
 - You can save the desired data depending on different conditions such as trigger collection, event collection, etc.
 - It supports the remote data access through FTP communication.
- (3) Embedded communication function
 - It has embedded Cnet 2 channels and Enet 1 channel at the same time.
 - It can communicate with other devices very easily without the special communication I/F module by using the embedded communication function.
 - It enhances convenience by providing various protocols such as dedicated communication, customization, etc.
 - You can check the communication state very easily thanks to the diagnosis function and transmitting-receiving frame monitoring function.
 - The 2 ports switch function embedded in Ethernet makes the configuration of line topology easier.
- (4) Embedded PID function
 - It supports the embedded PID control function up to 16 loops.
 - It provides parameter setting using XG5000, convenient loop state monitoring through trend monitor.
 - You can get the control constant easily by the improved automatic synchronization function.
 - You can improve control accuracy by using various additional functions such as PWM output, ΔMV , ΔPV , SV Ramp, etc.
 - It provides various control modes such as forward/reverse mixed operation, 2-stage SV PID control, cascade control, etc.
 - You can secure stability through various alarm functions such as PV MAX, PV change warning, etc.
- (5) Embedded position control function(Available for XBC-DN32UP/DP32UP/DR28UP type only)
 - The line drive output positioning function with up to 2Mpps 4-axis is embedded.
 - It provides parameter setting using XG-PM that is the exclusive setting tool, operation data edition, diverse monitoring and diagnosis functions.
 - You can conduct a trial run through XG-PM's monitoring without the program so you can easily check the external wirings and operation data.
- (6) Embedded analog I/O function(Available for XEC-DN32UA/DP32UA/DR28UA type only)
 - The analog input 4 channels(voltage/current), analog output 4channels(voltage 2 channels, current 2 channels) are embedded.
 - It can measure the analog value more accurately thanks to the high resolution of 14bit.
 - You can conduct a trial run through XG5000's monitoring without the program so you can easily check the external wirings and operation data.

1.3 Terminology

1.2.1 General term

The following table gives definition of terms used in this manual.

Terms	Definition	Remark
Module	A standard element that has a specified function which configures the system. Devices such as I/O board, which inserted onto the mother board.	Example) Expansion module, Specialmodule, Communication module
Unit	A single module or group of modules that perform an independent operation as a part of PLC systems.	Example) Main unit, Expansion unit
PLC System	A system which consists of the PLC and peripheral devices. A user program can control the system.	-
XG5000	A program and debugging tool for the MASTER-K series. It executes program creation, edit, compile and debugging. (PADT: Programming Added Debugging Tool)	-
XG - PD	Software to execute description, edition of basic parameter, high speed link, P2P parameter, and function of communication diagnosis	-
I/O image area	Internal memory area of the CPU module which used to hold I/O status.	
Cnet	Computer Network	-
FEnet	Fast Ethernet Network	-
RAPInet	RAPInet Network	-
CANopen	Controller Area Network	-
Pnet	Profibus-DP Network	-
Dnet	DeviceNet Network	-
RTC	Abbreviation of 'Real Time Clock'. It is used to call general IC that contains clock function.	-
Watchdog Timer	Supervisors the pre-set execution times of programs and warns if a program is not completed within the pre-set time.	-

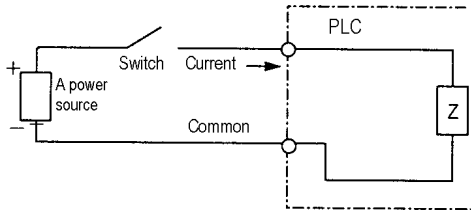
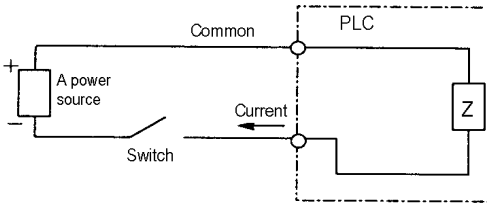
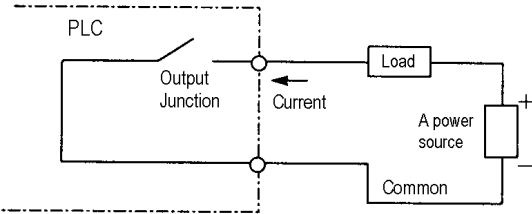
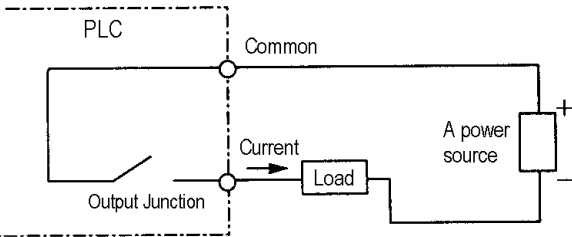
Terms	Definition	Remark
Sink Input	<p>Current flows from the switch to the PLC input terminal if a input signal turns on.</p> 	Z: Input impedance
Source Input	<p>Current flows from the PLC input terminal to the switch after a input signal turns on.</p> 	Z: Input impedance
Sink Output	<p>Current flows from the load to the output terminal and the PLC output turn on.</p> 	-
Source Output	<p>Current flows from the output terminal to the load and the PLC output turn on.</p> 	-

Chapter 1 Introduction

1.2.2 Serial communication term

(1) Communication type

(a) Simplex

This is the communication type that data is transferred in a constant direction. Information can not be transferred in the reverse direction.

(b) Half-Duplex

Data is transferred in two ways with one cable if time interval provided, though it can't be transferred simultaneously.

(c) Full-Duplex

Data is simultaneously transferred and received in two ways with two cables.

(2) Transmission type

(a) Serial transmission

This type transmits bit by bit via 1 cable. The speed of transmission is slow, but the cost of installation is low and the software is simplified.

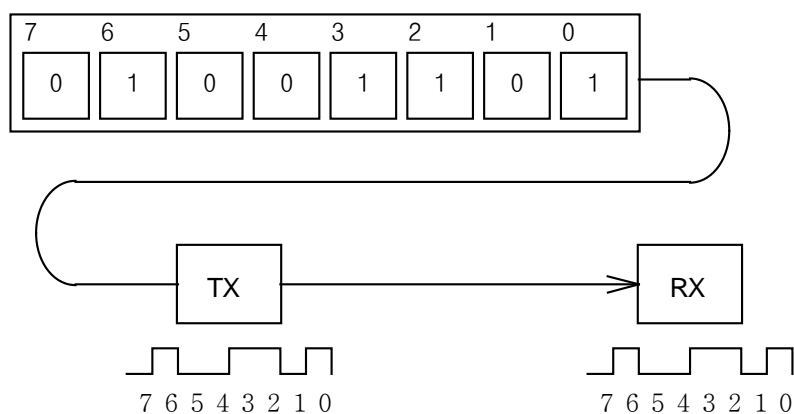

RS-232C, RS-422 and RS-485 are the examples

(b) Parallel transmission

This type is used in printer, etc., which transmits data in unit of 1 byte, so the speed is high and the accuracy of data is reliable. However, the longer the transmission distance is, the higher the cost of installation is geometrically.

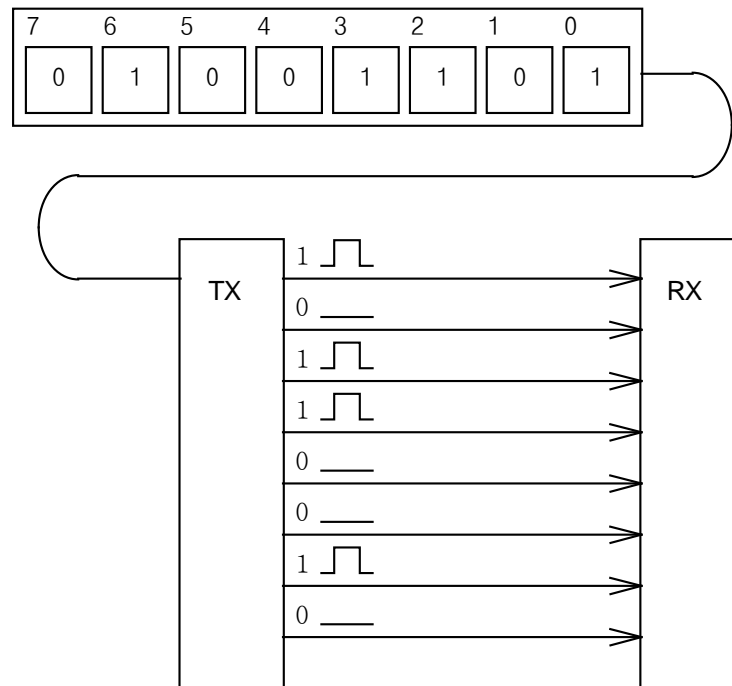

(3) Asynchronous Communication

This communication type transmits characters one by one synchronously in serial transmission. At this time, synchronous signal (Clock, etc.) is not transmitted. Character code is transmitted with a start bit attached to the head of 1 character, and it is finished with a stop bit attached to the tail.

※ For transmitting KOREA

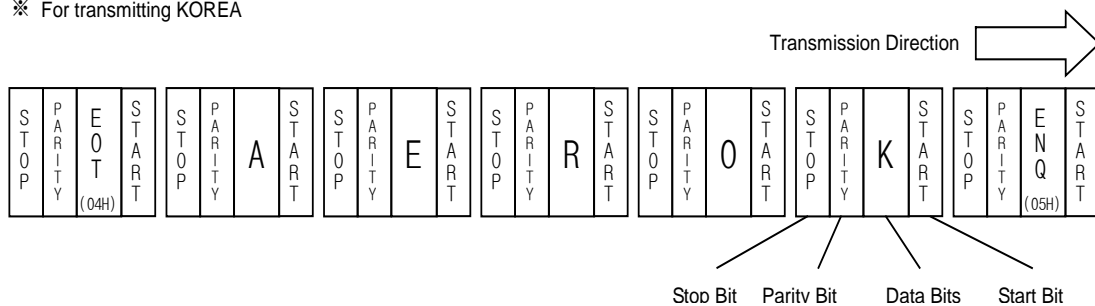

Chapter 1 Introduction

(4) Protocol

This is communication rule established in relation between the transmission side and the receiving side of information in order to send and accept information between two computers/terminals or more without error, effectively, and reliably. In general, this specifies call establishment, connection, structure of message exchange form, re-transmission of error message, procedure of line inversion, and character synchronization between terminals, etc.

(5) BPS(Bits Per Second)와 CPS(Characters Per Second)

BPS is a unit of transfer rate that represents how many bits are transferred per second. CPS is the number of the characters transferred for a second. Generally, one character is 1Byte (8Bits), so CPS is the number of bytes which can be transferred per second.

(6) Node

Node is a term that means the connected nodes of the data in the network tree structure, generally network is composed of a great number of nodes, and is also expressed as the station number.

(7) Packet

Packet, a compound term of package and bucket used for packet exchange type to send information as divided in a unit of packet, separates transferred data into the defined length to add a header that presents the correspondent addresses (station No., etc.) thereto.

(8) Port

Port is meant to be the part of the data process device which sends or receives the data from a remote control terminal in data communications, but in Cnet serial communication is meant to be the RS-232C or RS-422 port.

(9) RS-232C

RS-232C is the interface to link a modem with a terminal and to link a modem with a computer, and is also the serial communications specification established by EIA according to the recommendations of the CCITT. This is also used to link the null modem directly as well as the modem linkage. The disadvantage is that the transfer length is short and that only 1 : 1 communication is available, and the specifications which have overcome this disadvantage are RS-422 and RS-485.

(10) RS-422/RS-485

As one of the serial transmission specifications, its transferring length is long with 1 : N connection available compared to RS-232C. The difference of these two specifications is that RS-422 uses 4 signals of TX(+), TX(-), RX(+) and RX(-), while RS-485 has 2 signals of (+) & (-), where data is sent and received through the same signal line. Accordingly, RS-422 executes the full-duplex type of communication and RS-485 executes the half-duplex type of communication.

(11) Half Duplex Communication

Two-way communication is available, however simultaneous communication of transmission & receiving isn't available. This communication type is applied to RS-485 for instance. It is used a lot for multi-drop communication type which communicates via one signal line by several stations. Half Duplex Communication results from the transmission characteristic performed by stations one by one not allowing simultaneous transmission by multi stations due to the data damage of data impact caused by the simultaneous multi-transmission of the stations. The figure below shows an example of structure based on Half Duplex Communication. Each station in communication with the terminal as linked with each other can send or receive data via one line so to execute communication with all stations, where multi-sever is advantageously available.

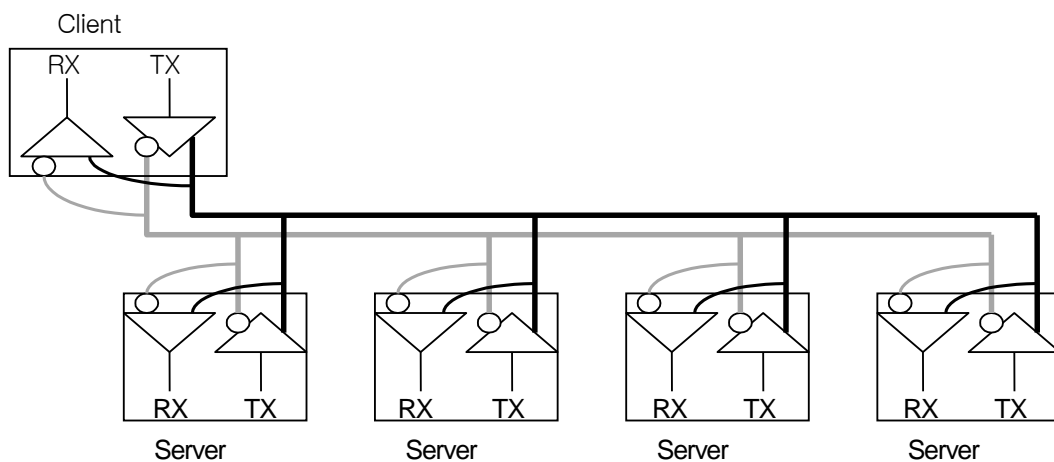

(12) Full Duplex Communication

Two way-communications of simultaneous transmission & receiving is available. This communication type is applied to RS-232C & RS-422. Since the transmission line is separated from the receiving line, simultaneous transmission & receiving is available without data impact, so called as Full Duplex Communication. The figure shows an example of structure based on RS-422 of Full Duplex Communication. Since transmission terminal of the client station and receiving terminals of the sever stations are connected to one line, and transmission terminals of the sever stations are linked with receiving terminal of the client station, the communication between sever stations is unavailable with the restricted function of multi-sever.

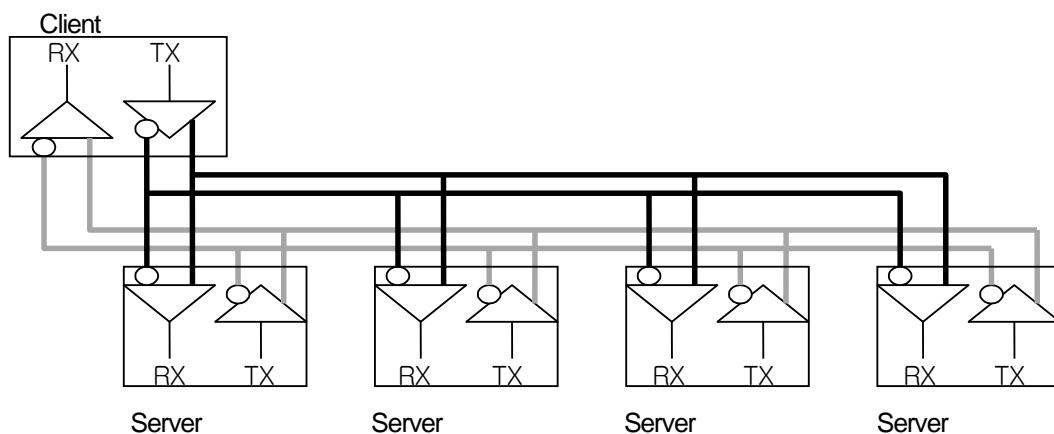

Chapter 1 Introduction

(13) BCC (Block Check Character)

As serial transmission may have signals distorted due to undesirable noise in transmission line, BCC is used as data to help receiving side to check the signals if normal or distorted and to detect errors in signals as compared with the received BCC after calculating BCC by receiving side itself using the data input to the front terminal of BCC.

(14) XG5000 service

This is the function to remotely perform programming, reading/writing user's program, debugging, and monitoring, etc. without moving the physical connection of XG5000 in the network system where PLC is connected to Cnet I/F module. Especially, it is convenient to control a remote PLC via modem.

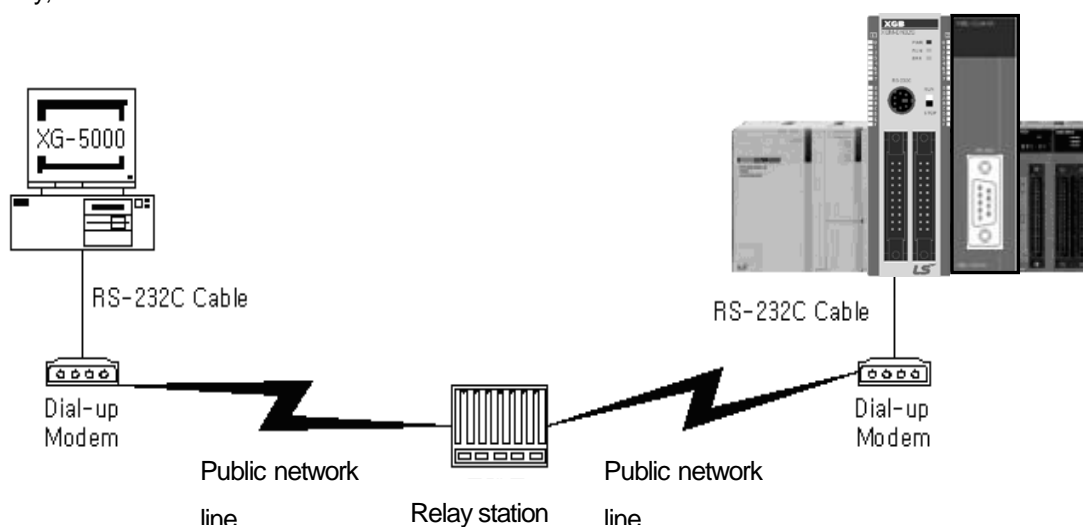

* XG5000 : Programming software of XGT PLC for Windows

(15) Frame

Frame is composed of transmitted and received data as in a specified form in data communication including additional information of segments [station No., command, parameter by command], control characters [ENQ, ACK, EOT, ETX] for synchronization, parity for detecting error, and BCC. The structure of frame used for serial communication of Cnet is as follows.

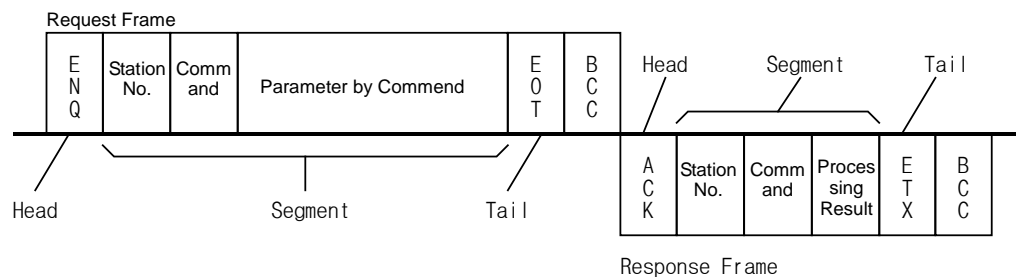

[Structure of general Tx/Rx frame]

- Head: ASCII value indicating frame start.
- Tail: ASCII value indicating frame end.
- BCC (Block Check Character)
 - ◆ Check data for Tx/Rx frame
 - ◆ Used to inspect reliability of data with such various methods as ADD, OR, Exclusive OR, MULTPLY, etc

(16) Reset

This function is used to initialize the communication module with errors.

Use XG-PD to select [On-Line] → [Reset] so to execute Reset, which will restart PLC.

1.2.3 Ethernet term

This chapter describes about the general terminology of FEnet I/F module. For more detail, refer to professional book on the Ethernet

(1) IEEE 802.3

IEEE 802.3 specifies standards for CSMA/CD based Ethernet. Exactly it is a LAN based on CSMA/CD (Carrier Sense Multiple Access with Collision Detection) Ethernet designed by IEEE 802.3 group, which is classified into detailed projects as specified below;

- A) IEEE P802.3 - 10G Base T study Group
- B) IEEE P802.3ah - Ethernet in the First Mile Task Force
- C) IEEE P802.3ak - 10G Base-CX4 Task Force

※ Ethernet and IEEE 802.3 are standardized at RFC894 and RFC1042 so each should process another frame.

(2) ARP (Address Resolution Protocol)

Protocol to search for MAC address by means of correspondent IP address on the Ethernet LAN

(3) Bridge

A device used to connect two networks so to be operated as one network. Bridge is used not only to connect two different types of networks but also to divide one big network into two small networks in order to increase the performance

(4) Client

A user of the network service, or a computer or program (mainly the one requesting services) using other computer's resource.

(5) CSMA/CD(Carrier Sense Multiple Access with Collision Detection)

Each client checks if there is any sign prior to transmission of data to the network (Carrier Sense) and then sends its data when the network is empty. At this time, all the clients have the equal right to send (Multiple Access). If two or more clients send data, collision may occur. The client who detects the collision tries to send again in a specific time.

(6) DNS (Domain Name System)

A method used to convert alphabetic Domain Name on the Internet to its identical Internet number (namely, IP address)

(7) Dot Address

Shows IP address of '100.100.100.100', where each figure is displayed in decimal with 1 byte occupied respectively for 4 bytes in total.

(8) E-mail Address

The address of the user with login account for the specific machine connected via the Internet. Usually user's ID @ domain name (machine name) is assigned. In other words, it will be like hjjee@microsoft.com, where @ is called as 'at' displayed with shift+2 pressed on the keyboard. The letters at the back of @ are for the domain name of specific company (school, institute,..) connected with the Internet, and the letters in front of @ are for the user ID registered in the machine. The last letters of the domain name are for the highest level. USA generally uses the following abbreviation as specified below, and Korea uses .kr to stand for Korea. .com : usually for companies) / .edu : usually for educational organizations such as universities. / .ac(academy) is mostly used in Korea / .gov : for governmental organizations. For example, nasa.gov is for NASA (government) / .mil : military related sites. For example, af.mil is for USA air force (military)/ .org : private organizations / .au : Australia / .uk : the United Kingdom / .ca : Canada / .kr : Korea / .jp : Japan / .fr : France / .tw : Taiwan, etc.

(9) Ethernet

A representative LAN connection system (IEEE 802.3) developed by Xerox, Intel and DEC of America which can send about 10Mbps and use the packet of 1.5kB. Since Ethernet can allow various types of computers to be connected as one via the network, it has been called a pronoun of LAN as a universal standard with various products available, not limited to some specific companies.

(10) FTP (File Transfer Protocol)

An application program used to transfer files between computers among application programs providing TCP/IP protocol. If an account is allowed to the computer to log in, fast log in the computer is available wherever the computer is so to copy files.

(11) Gateway

Software/Hardware used to translate for two different protocols to work together, which is equivalent to the gateway necessary to exchange information with the different system.

(12) Header

Part of the packet including self station number, correspondent station number and error checking area.

(13) HTML

Hypertext Markup Language, standard language of WWW. In other words, it is a language system to prepare Hypertext documents. The document made of HTML can be viewed through the web browser

(14) HTTP

Hypertext Transfer Protocol, standard protocol of WWW. It is a protocol supporting the hypermedia system.

(15) ICMP (Internet Control Message Protocol)

An extended protocol of IP address used to create error messages and test packets to control the Internet.

(16) IP (Internet Protocol)

Protocol of network layers for the Internet

(17) IP Address

Address of respective computers on the Internet made of figures binary of 32 bits (4 bytes) to distinguish the applicable machine on the Internet. Classified into 2 sections, network distinguishing address and host distinguishing address. The network address and the host address is respectively divided into class A, B and C based on the bits allotted. IP address since it shall be unique all over the world, shall be decided not optionally but as assigned by NIC(Network Information Center) of the applicable district when joining the Internet. In Korea, KRNIC(Korea Network Information Center) is in charge of this work. Ex.) 165.244.149.190

(18) ISO (International Organization for Standardization)

A subsidiary organization of UN establishing and managing the international standards

(19) LAN (Local Area Network)

Called also as local area communication network or district information communication network, which allows lots of computers to exchange data with each other as connected though communication cable within a limited area such as in an office or a building

(20) MAC (Medium Access Control)

A method used to decide which device should use the network during given time on the broadcast network

(21) Node

Each computer connected with the network is called Node

(22) Packet

A package of data which is the basic unit used to send through the network. Usually the package is made of several tens or hundreds of bytes with the header attached in front to which its destination and other necessary information are added

(23) PORT number

Used to classify the applications on TCP/UDP.

Ex.) 21/tcp : Telet

(24) PPP (Point-to-Point Protocol)

Phone communication protocol which allows packet transmission in connecting with the Internet. In other words, normal phone cable and modem can be used for the computer to connect through TCP/IP with this most general Internet protocol.

Similar to SLIP, however with modern communication protocol factors such as error detection and data compression, it demonstrates more excellent performance than SLIP.

(25) Protocol

Contains regulations related with mutual information transmission method between computers connected with each other through the network. The protocol may specify detailed interface between machines in Low level (for

example, which bit/byte should go out through the line) or high level of message exchange regulations as files are transferred through the Internet.

(26) Router

A device used to transfer the data packet between the networks. It sends the data packet to its final destination, waits if the network is congested, or decides which LAN is good to connect to at the LAN junction. Namely, it is a special computer/software used to control the two or more networks connected.

(27) Server

The side which passively responds to the client's request and shares its resources.

(28) TCP (Transmission Control Protocol)

A transport layer protocol for the Internet

- Data Tx/Rx through connection
- Multiplexing
- Transmission reliable
- Emergent data transmission supported

(29) TCP/IP (Transmission Control Protocol/Internet Protocol)

Transmission protocol used for communication among different kinds of computers, which makes the communication available between general PC and medium host, IBM PC and MAC, and medium or large-sized different types of computer. It is also used as a general term for information transmission protocol between computer networks including FTP, Telnet, SMTP, etc. TCP divides data into packets to send through IP and the packets sent will be united back together through TCP.

(30) Telnet

It means remote login via Internet. To login to remote host via TELNET, account of that host is necessary. But for some hosts providing public service, you can connect without account

Chapter 1 Introduction

(31) Token Ring

As short-distance network using Token to connect to network having physical ring structure, one of the Node connection methods at network. If node sending data gets Token, then node gets right to send message packet. Realistically structured examples are IEEE 802.5, ProNet-1080 and FDDI. Terms called Token is used as IEEE 802.5

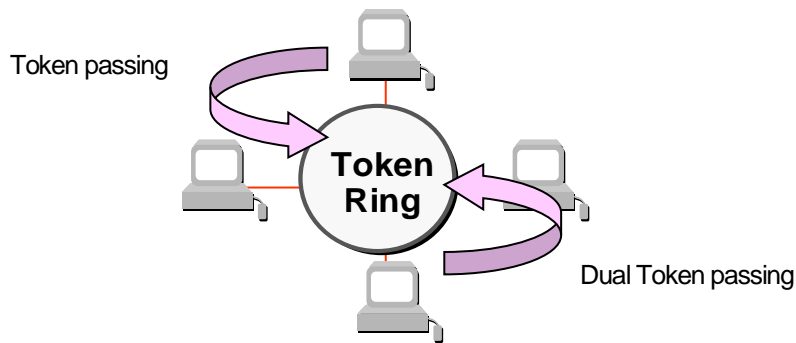

(32) UDP(User Datagram Protocol)

A transport layer protocol for the Internet

- High speed communication because of communication without connection
- Multiplexing
- Lower reliability than TCP in transmission (Tough data doesn't arrive, it doesn't send data again)

(33) Auto-Negotiation FDDI(Fiber Distributed Data Interface)

Based on optical cable, provides 100Mbps, Shared Media Network as Dual Ring method, Token Passing is done in two-way.

Max 200Km distance for entire network, Max 2Km between Nodes, Max 500 nodes. Generally, this used as Backbone Network.

(35) Reset

This is function used when you want to initialize the communication module to clear the error

Select [Online] → [Rest] in the XG-PD

If you execute this function, PLC will restart.

Chapter 2 System Configuration

You can configure various systems by using the XGB 'U' Type basic unit and expansion special communication I/F modules. This chapter describes how to configure the system through the the XGB 'U' Type basic unit

2.1 Table of Products Configuration

The available configurations of for the high performance small-sized PLC system are as below table.

Types	Model	Description	Remark
Main Unit	XEC-DN32U	AC100-220V power supply, DC24V input 16 point, Transistor output 16 point(sink)	Basic type
	XEC-DN32U	AC100-220V power supply, DC24V input 16 point, Transistor output 16 point(source)	
	XEC-DR28U	AC100-220V power supply, DC24V input 16 point, Relay output 12 point	
	XEC-DN32U/DC	DC24V power supply, DC24V input 16 point, Transistor output 16 point(sink)	
	XEC-DN32U/DC	DC24V power supply, DC24V input 16 point, Transistor output 16 point(source)	
	XEC-DR28U/DC	DC24V power supply, DC24V input 16 point, Relay output 12 point	
	XEC-DN32UP	AC100-220V power supply, DC24V input 16 point, Transistor output 16 point(sink) Positioning 4axis	Positioning type
	XEC-DN32UP	AC100-220V power supply, DC24V input 16 point, Transistor output 16 point(source) Positioning 4axis	
	XEC-DR28UP	AC100-220V power supply, DC24V input 16 point, Relay output 12 point Positioning 4axis	
	XEC-DN32UP/DC	DC24V power supply, DC24V input 16 point, Transistor output 16 point(sink) Positioning 4axis	
	XEC-DN32UP/DC	DC24V power supply, DC24V input 16 point, Transistor output 16 point(source) Positioning 4axis	
	XEC-DR28UP/DC	DC24V power supply, DC24V input 16 point, Relay output 12 point Positioning 4axis	
	XEC-DN32UA	AC100-220V power supply, DC24V input 16 point, Transistor output 16 point (sink) Analog 8 Channel	Analog type
	XEC-DN32UA	AC100-220V power supply, DC24V input 16 point, Transistor output 16 point(source) Analog 8 Channel	
	XEC-DR28UA	AC100-220V power supply, DC24V input 16 point, Relay output 12 point Analog 8 Channel	
	XEC-DN32UA/DC	DC24V power supply, DC24V input 16 point, Transistor output 16 point (sink) Analog 8 Channel	
	XEC-DN32UA/DC	DC24V power supply, DC24V input 16 point, Transistor output 16 point(source) Analog 8 Channel	
	XEC-DR28UA/DC	DC24V power supply, DC24V input 16 point, Relay output 12 point Analog 8 Channel	
Expansion Unit	XBE-DC08A	DC24V Input 8 point	Input
	XBE-DC16A/B	DC24V Input 16 point	
	XBE-DC32A	DC24V Input 32 point	
	XBE-AC08A	AC 110V Input 8 point	Output
	XBE-RY08A	Relay output 8 point	
	XBE-RY08B	Relay output 8 point(isolated output)	
	XBE-RY16A	Relay output 16 point	
	XBE-TN08A	Transistor output 8 point (sink type)	
	XBE-TN16A	Transistor output 16 point (sink type)	
	XBE-TN32A	Transistor output 32 point (sink type)	

Types	Model	Description	Remark
	XBE-TP08A	Transistor output 8 point (source type)	In/Output
	XBE-TP16A	Transistor output 16 point (source type)	
	XBE-TP32A	Transistor output 32 point (source type)	
	XBE-DR16A	DC24V Input 8 point, Relay output 8 point	
	XBE-DN32A	DC24V Input 16 point, Transistor output 16 point (sink type)	
Special Module	XBF-AD04A	Current/Voltage input 4 channel, 1/4000 resolution	Analog In/Out
	XBF-AD04C	Current/Voltage input 4 channel, 1/16000 resolution	
	XBF-AD08A	Current/Voltage input 8 channel, 1/4000 resolution	
	XBF-DC04A	Current output 4 channel, 1/4000 resolution	
	XBF-DC04C	Current output 4 channel, High resolution, 1/16000 resolution	
	XBF-DV04A	Voltage output 4 channel, 1/4000 resolution	
	XBF-DV04C	Voltage output 4 channel, 1/16000 resolution	
	XBF-AH04A	Current/Voltage input 2 channel, Current/Voltage output 2 channel, 1/4000 resolution	
Special Module	XBF-AH04A	Current/Voltage input 2 channel, Current/Voltage output 2 channel, 1/4000 resolution	Temperature
	XBF-RD04A	RTD (Resistance Temperature Detector) input 4 channel, Pt100, Jpt100	
	XBF-RD01A	RTD (Resistance Temperature Detector) input 1 channel, Pt100, Jpt100	
	XBF-TC04S	TC (Thermocouple) input 4 channel	Positioning
	XBF-PD02A	Position 2Axis, Line Drive type, Max 2Mpps	
	XBF-HD02A	High Speed Counter 2 channel, Line Drive Type	Counter
	XBF-HO02A	High Speed Counter 2 channel, Open Collector Type	
	XBF-TC04RT	Temperature controller module (RTD input, 4 roof)	-
	XBF-TC04TT	Temperature controller module (TC input, 4 roof)	-
	XBF-PN08B	Network position (Open type Ethercat) 8 Axis	-
	XBF-LD02S	Loadcell input, insulation type	
Communication Module	XBL-C21A	Cnet (RS-232C/Modem) I/F	-
	XBL-C41A	Cnet (RS-422/485) I/F	-
	XBL-EMTA	Enet I/F	-
	XBL-EIMT/F/H	RAPIDnet I/F 2 UTP cable	-
	XBL-EIPT	EtherNet I/P Module	-
	XBL-CMEA	CANopen Master I/F	-
	XBL-CSEA	CANopen Slave I/F	-
	XBL-PMEC	Profibus-DP, Master	-
	XBL-PSEA	Profibus-DP, Slave	
	XBL-DSEA	DeviceNet, Slave	
	USB-301A	Connection cable (PC to PLC), USB	--

Chapter 2 System Configuration

Notice

- (1) LS ELECTRIC CO., LTD. has consistently developed and launched new products. For new products that are not included to this manual, please contact a nearby exclusive agency.
- (2) Use USB cable within 3m length and use shield cable like USB-301A.
- (3) Because some PCs are weak to noise, we recommend using a USB hub.

2.2 Classification and Type of Product Name

2.2.1 Classification and type of basic unit

Name of basic unit is classified as follows.

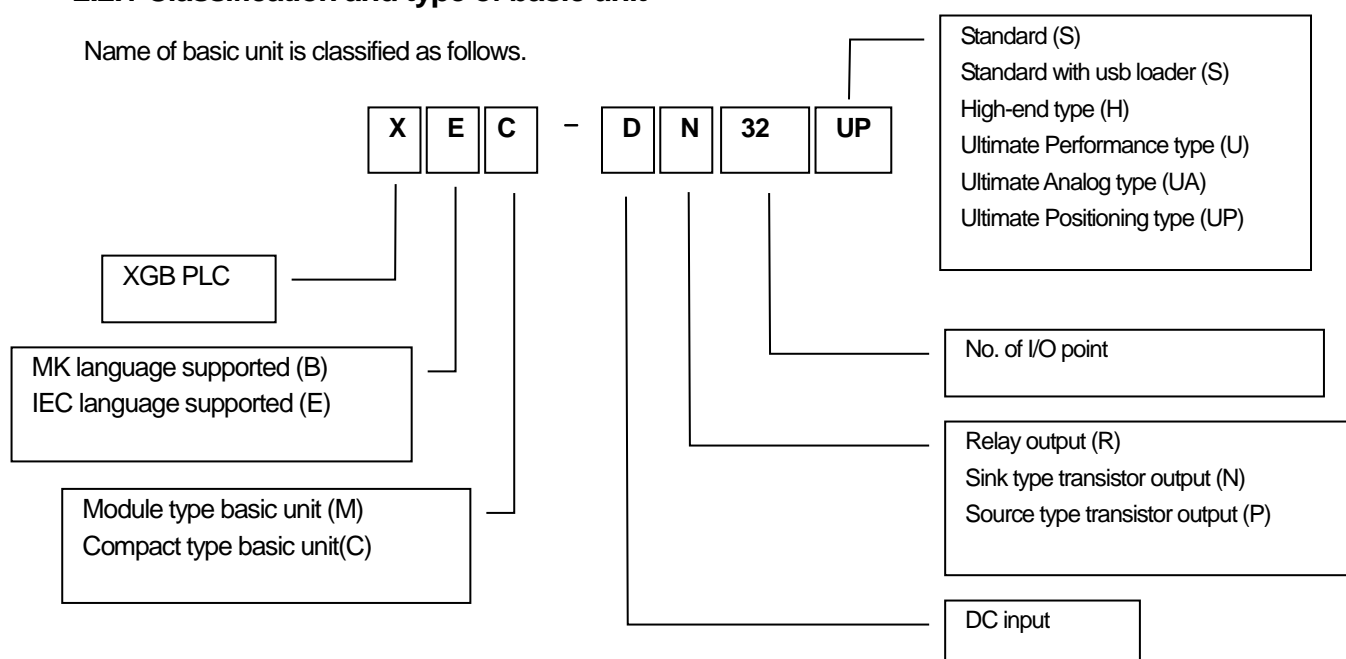

Classification	Name	DC input	Relay output	Transistor output	Power
Compact type basic unit	XEC-DN32U	16 point	None	16 point	AC110V-220V
	XEC-DP32U	16 point	None	16 point	
	XEC-DR28U	16 point	12 point	None	
	XEC-DN32UP	16 point	None	16 point	
	XEC-DP32UP	16 point	None	16 point	
	XEC-DR28UP	16 point	12 point	None	
	XEC-DN32UA	16 point	None	16 point	
	XEC-DP32UA	16 point	None	16 point	
	XEC-DR28UA	16 point	12 point	None	
	XEC-DN32U/DC	16 point	None	16 point	DC24V
	XEC-DP32U/DC	16 point	None	16 point	
	XEC-DR28U/DC	16 point	12 point	None	
	XEC-DN32UP/DC	16 point	None	16 point	
	XEC-DP32UP/DC	16 point	None	16 point	
	XEC-DR28UP/DC	16 point	12 point	None	
	XEC-DN32UA/DC	16 point	None	16 point	
	XEC-DP32UA/DC	16 point	None	16 point	
	XEC-DR28UA/DC	16 point	12 point	None	

2.2.2 Classification and type of expansion module

Name of expansion module is classified as follows.

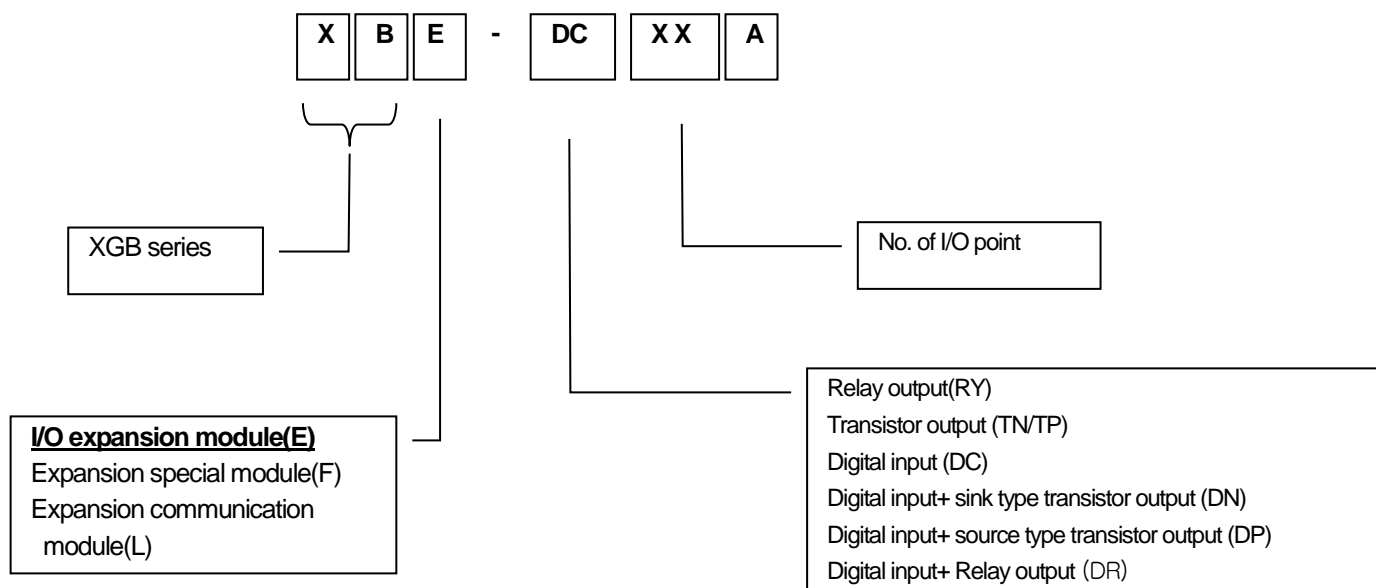

Name	DC input	Relay output	Transistor output	Reference
XBE-DC08A	8 point	None	None	Input
XBE-DC16A/B	16 point	None	None	
XBE-DC32A	32 point	None	None	
XBE-AC08A	8 point (AC)	None	None	Relay Output
XBE-RY08A/B	None	8 point	None	
XBE-RY16A	None	16 point	None	Sink type Output
XBE-TN08A	None	None	8 point (sink type)	
XBE-TN16A	None	None	16 point (sink type)	
XBE-TN32A	None	None	32 point (sink type)	Source type Output
XBE-TP08A	None	None	8 point (source type)	
XBE-TP16A	None	None	16 point (source type)	
XBE-TP32A	None	None	32 point (source type)	In/Output
XBE-DR16A	8 point	8 point	None	
XBE-DN32A	16 point	None	16 point (sink type)	

Chapter 2 System Configuration

2.2.3 Classification and type of special module

Special module is classified as follows.

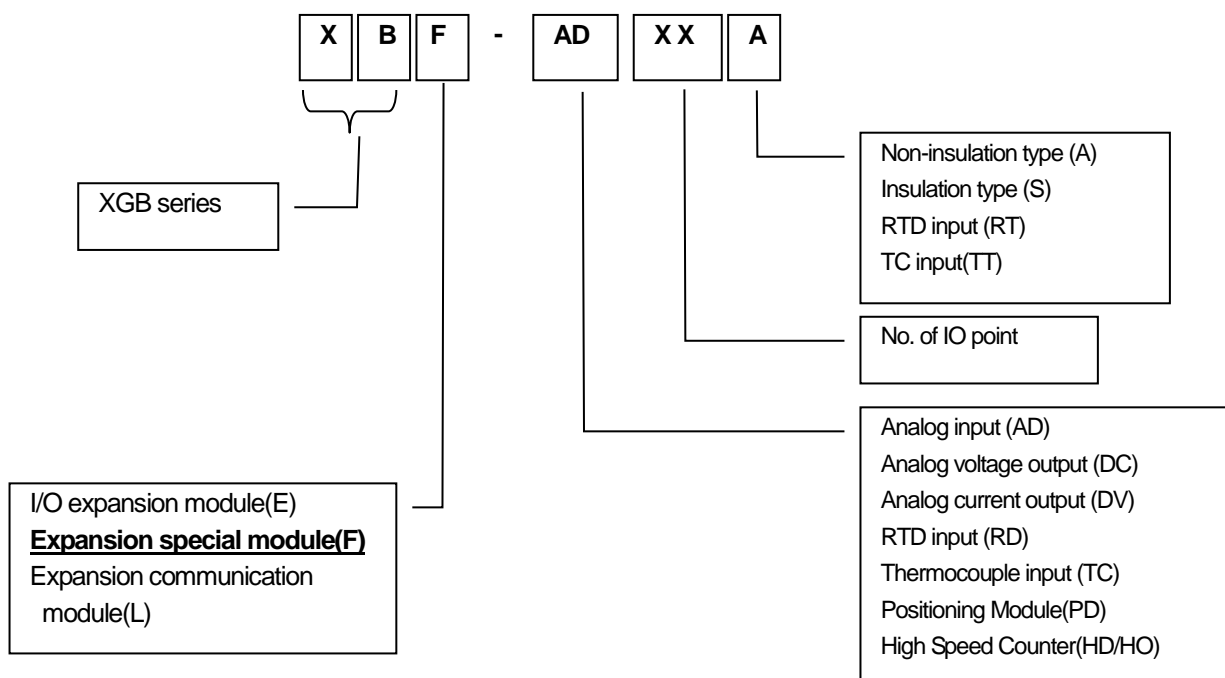

Classification	Name	No. of input ch.	Input type	No. of output ch.	Output type
Analog input	XBF-AD04A/C	4	Voltage/Current	None	-
	XBF-AD08A	8	Voltage/Current	None	-
Analog output	XBF-DC04A/C	None	-	4	Current
	XBF-DV04A/C	None	-	4	Voltage
RTD input	XBF-RD04A	4	PT100/JPT100	None	-
	XBF-RD01A	1	PT100/JPT100	None	-
TC input	XBF-TC04S	4	K, J, T, R	None	-
	XBF-TC04RT	4	PT100/JPT100	4	Transister
	XBF-TC04TT	4	K, J, T, R	4	Transister
Positioning	XBF-PD02A	-	Line Driver	2	Voltage
	XBF-PN08B	-	Line Driver	8	EtherCAT
High Speed Counter	XBF-HD02A	2	Line Driver	-	Voltage
	XBF-HO02A	2	Open Collector	-	Voltage
Loadcell	XBF-LD02S	2	Voltage		

2.2.4 Classification and type of communication module

Name of communication module is classified as follows.

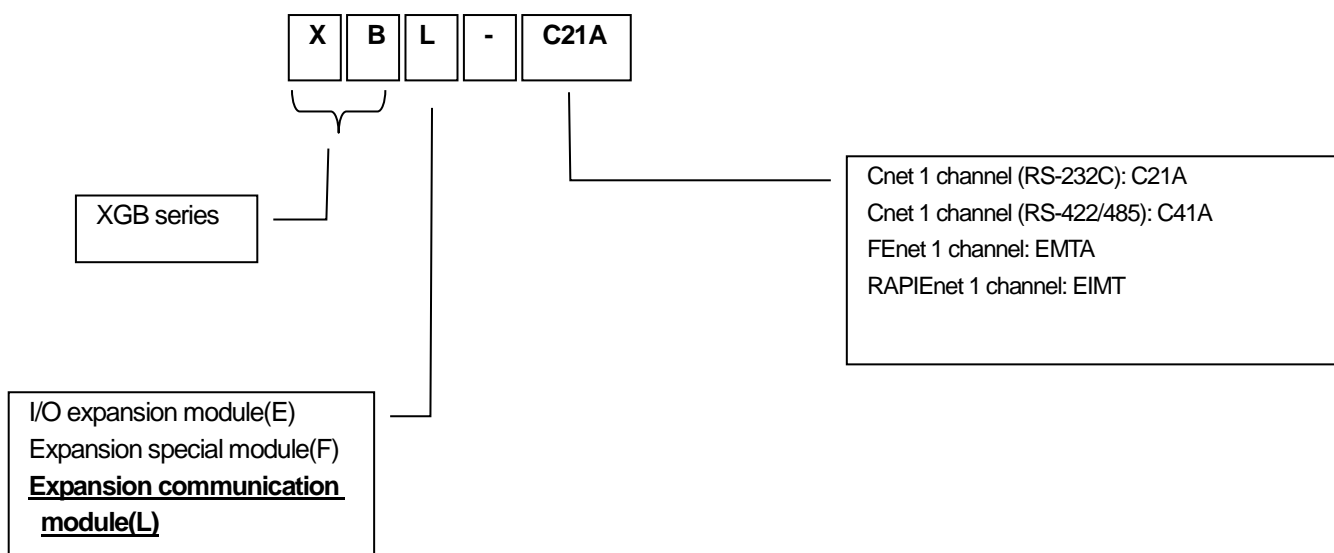

Classification	Name	Type
Cnet Comm. Module	XBL-C21A	RS-232C, 1 channel
	XBL-C41A	RS-422/485, 1 channel
FEnet Comm. Module	XBL-EMTA	Electricity, open type Ethernet
RAPIEnet Comm. Module	XBL-EIMT/EIMF/EIMH	Comm. Module between PLCs, electric media, 100 Mbps industrial Ethernet supported
EtherNet Comm. Module	XBL-EIPT	Open EtherNet I/P
CANopen Comm. Module	XBL-CMEA	CANopen Master
	XBL-CSEA	CANopen Slave
Pnet Comm. Module	XBL-PMEC	Profibus-DP Master
	XBL-PSEA	Profibus-DP Slave
DeviceNet Comm. Module	XBL-DSEA	DeviceNet Slave

Chapter 2 System Configuration

2.3 XGB 'U' Type's System Configuration

2.3.1 How to configure the System

You can configure the system by using the high performance XGB PLC as below.

You can connect to the expansion modules up to 10EA.

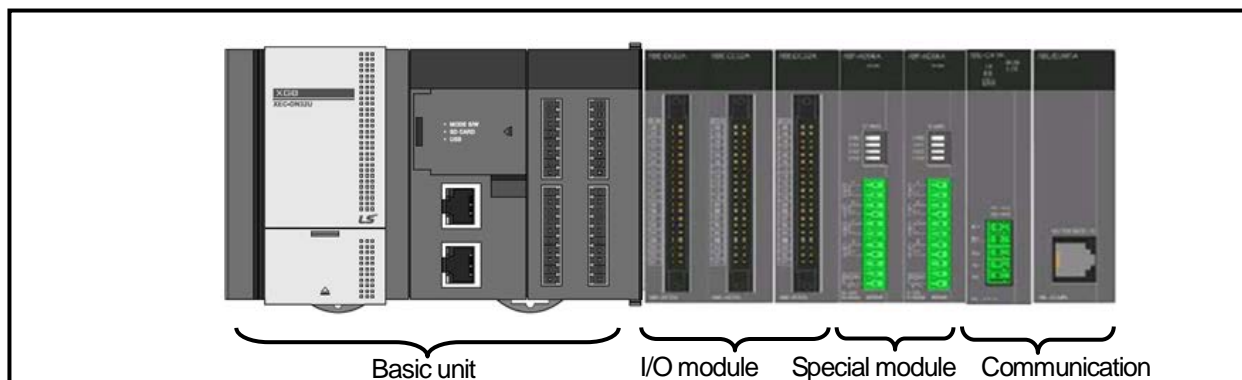

Items		Description				
Number of I/O configuration points		<ul style="list-style-type: none"> • XEC-DN32U/(DC), XEC-DN32UP/(DC), XEC-DN32UA/(DC) :32 points ~ 352 points • XEC-DP32U/(DC), XEC-DP32UP/(DC), XEC-DP32UA/(DC) :32 points ~ 352 points • XEC-DR28U/(DC), XEC- DR28UP/(DC), XEC- DR28UA/(DC) :28 points ~ 348 points 				
Number of accessible expansion modules	Digital I/O module	• Up to 10 EA				
	Special module	• Up to 10 EA				
	Communication module	• Up to 2 EA				
	High speed expansion module	• Up to 2 EA (Can be expanded for 2 slots just behind the basic unit)				
	Option module	• Cannot be installed.				
Configuration of products	Unit	Basic	Basic type	• XEC-DN32U/(DC)	• XEC-DP32U/(DC)	• XEC-DR28U/(DC)
		Positioning type	• XEC-DN32UP/(DC)	• XEC-DP32UP/(DC)	• XEC-DR28UP/(DC)	
		Analog type	• XEC-DN32UA/(DC)	• XEC-DP32UA/(DC)	• XEC-DR28UA/(DC)	
	Expansion module	Digital I/O module	• XBE-DC08/16/32A	• XBE-TN08/16/32A	• XBE-RY08/16A	
			• XBE-DC16B	• XBE-TP08/16/32A	• XBE-RY08B	
			• XBE-AC08A	• XBE-DR16A		
		Special module	• XBF-AD04A	• XBF-DC04A	• XBF-HO02A	
	• XBF-AD04C		• XBF-DC04C	• XBF-HD02A		
	• XBF-AD08A		• XBF-DV04A	• XBF-TC04RT		
	• XBF-AH04A		• XBF-DV04C	• XBF-TC04TT		
• XBF-RD04A	• XBF-TC04S		• XBF-LD02S			
• XBF-RD01A	• XBF-PD02A					
Communication module	• XBL-C41A	• XBL-C21A	• XBL-PSEA			
	• XBL-EMTA	• XBL-EIMT/F/H	• XBL-CMEA/CSEA			
	• XBL-PMEC	• XBL-EIPT	• XBL-DSEA			
High speed I/F module	• XBF-PN08B	• XBF-PN04B				

2.3.2 Instructions for System Configuration

(1) High speed expansion module

XGB 'U' type PLC supports high-speed expansion I/F to speed up expansion module processing.

This section explains the precautions when configuring the system using the high-speed expansion module and the general expansion module.

- There are two types of high-speed expansion modules using high-speed expansion I/F: XBF-PN04B and XBF-PN08B.
- XGB 'U' type can use both general and high-speed expansion modules.
- The high-speed expansion module can be installed only in the 2nd or 3rd slot.
- If the high-speed expansion module is installed in the 3rd slot, the high-speed expansion module must be present in the 2nd slot as well.
- High-speed expansion module cannot be installed behind general expansion module. Therefore, the high-speed expansion module and the general expansion module In case of mixed use, the general expansion module must be installed behind the high-speed expansion module.
- Expansion communication module can be installed up to 2 units as before.
- The table below shows an example of system configuration when using a high-speed expansion module and a general expansion module.

(◇ : General expansion module (Special, I/O), ◎ : General expansion module (Communication), ◆ : High speed expansion modules)

Basic Unit	Slot Number					Definitions of Operations	Remarks
	No.1	No.2	No.3	No.4	No.6-8		
XGB 'U' Type	◆	◆	◎	◎	◇	Slots 2 and 3: high-speed expansion module, slots 3-8: general expansion module	2 communication modules works
	◆	◎	◎	◇	◇	Slots 2 and 3: high-speed expansion module, slots 3-8: general expansion module	2 communication modules works
	◇	◆	◎	◇	◇	Not configurable e (Cannot use high-speed expansion module after general expansion module)	
	◆	◆	◆	◇	◇	Not configurable (exceeds the allowable number of high-speed expansion modules)	
	◎	◎	◎	◇	◇	Not configurable (exceeds the allowable number of communication modules)	
	◇	◇	◎	◎	◇	Consists of only general expansion modules	2 communication modules works
Existing XGB	◎	◎	◇	◇	◇	Consists of only general expansion modules	2 communication modules works
	◎	◎	◎	◇	◇	Not configurable (exceeds the allowable number of communication modules)	
	◆	◎	◎	◇	◇	Not configurable (high-speed expansion module is not supported)	

(2) How to allocate slots for expansion modules

Chapter 2 System Configuration

- In the case of the high performance XGB PLC, the embedded special functions (built-in positioning or analog) occupies No.1 slot. Accordingly, No.2 slot is allocated for the first expansion module.
- In the case of the high performance XGB basic type(XEC-DN32U/DR28U) that cannot support the embedded special functions, the empty slot is allocated for No.1.

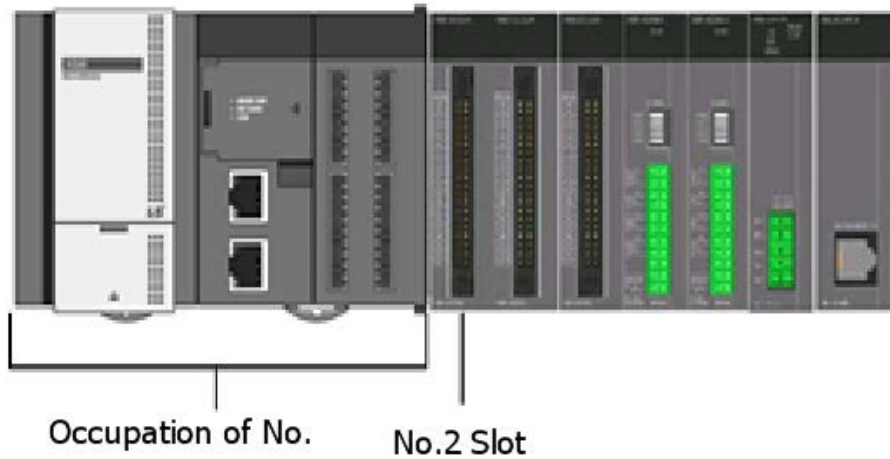

2.3.3 Embedded Communication System Configuration

2.3.3.1 Embedded Cnet I/F System Configuration

The Cnet I/F system is the system to transmit/receive external devices including PC and data through RS-232C/RS-422 I/F. In the case of the high performance XGB PLC, RS-232C and RS-485 communication I/F are respectively embedded. Moreover, you can additionally install the Cnet I/F module (XBL-C21A) for RS-232C only that is the expansion module and Cnet I/F module (XBL-C41A) for 485 only so it is possible to build up various communication systems for the purposes.

Some examples of communication systems are represented here, which can be configured by the Cnet I/F embedded in the high performance XGB basic unit.

(1) 1:1 connection with the HMI by using the basic unit's embedded RS-232C or RS-485 port

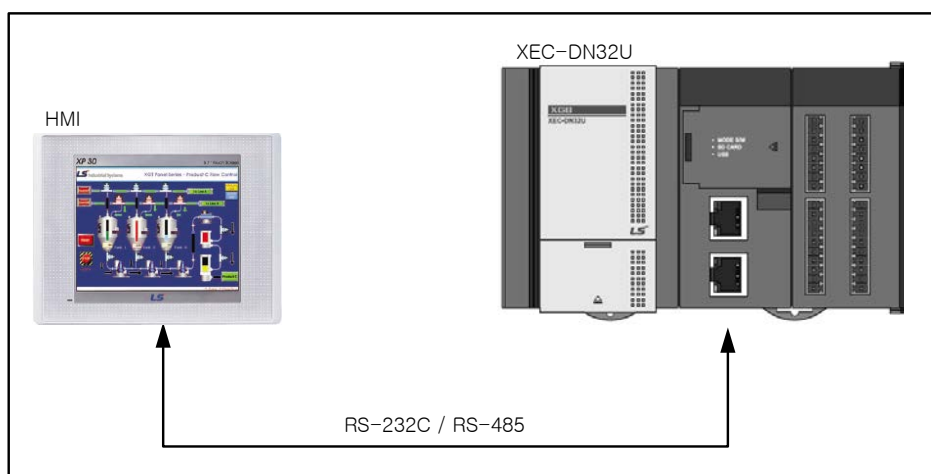

(2) Communication with the other PLC through the basic unit's embedded RS-485 port/ 1:1 connection with the HMI through the embedded RS-232C port

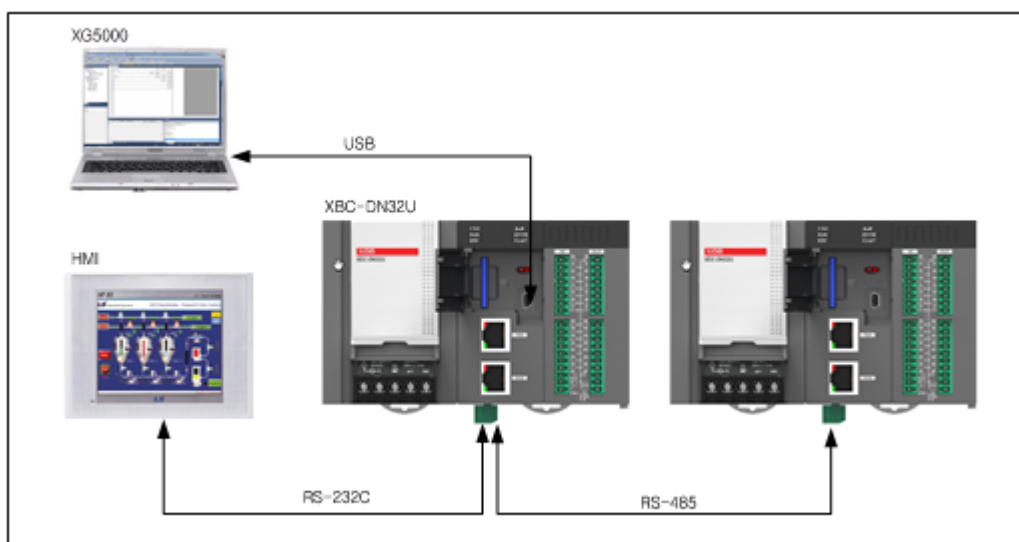

Chapter 2 System Configuration

- (3) Configuring 1:N communication system with the maximum 32 stations by using the basic unit's embedded RS-485 port

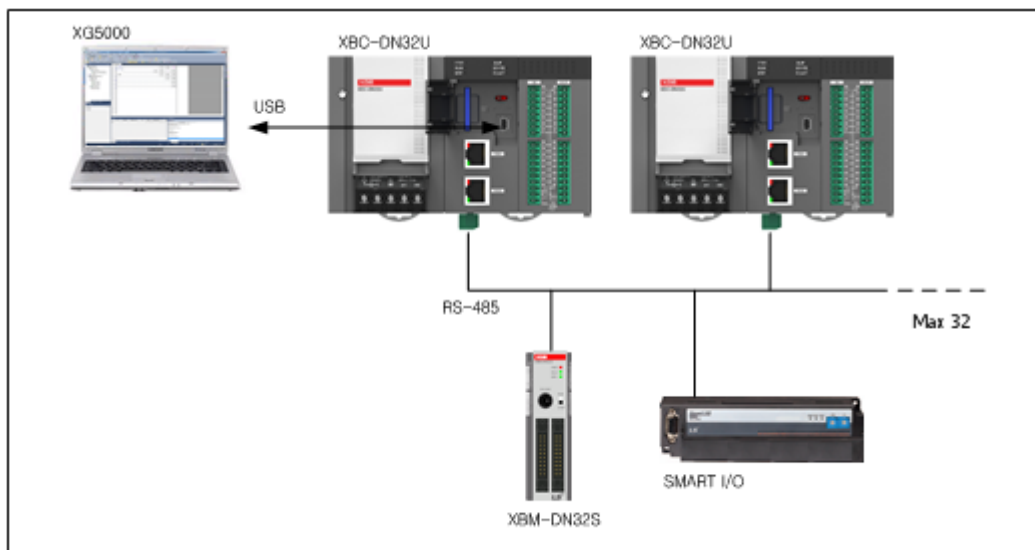

Notice

For detailed specifications of the high performance XGB's embedded Cnet communication, refer to Chap.5 Embedded Communication of this manual.

For detailed specifications of the expansion Cnet communication module, refer to "XGB Cnet I/F" of the manual.

2.3.3.2 Embedded Ethernet I/F System Configuration

The Ethernet is the typical LAN interface (IEEE802.3) developed commonly by Xerox, Intel, DEC of U.S.A. It is the network connection system with the transfer capacity of 100Mbps and packets of 1.5kB. The Ethernet can integrate different types of computers through network so it is regarded as the representative LAN interface. It is not the standard for a specific company but the common standard so you can find various products. In addition, it can control communication through CSMA/CD and builds up the network easily, furthermore, can collect high-capacity data.

(1) Ethernet system's block diagram

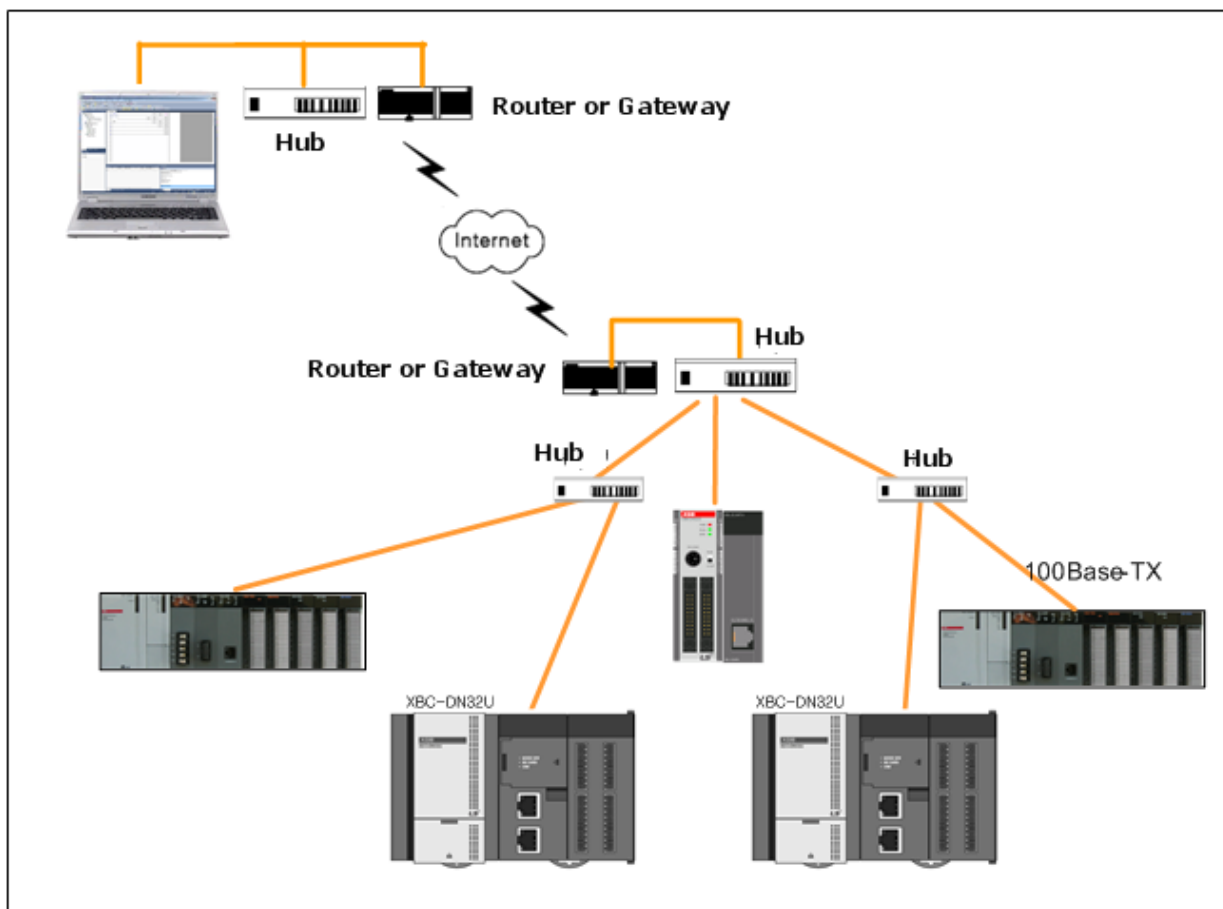

Notice

For more details on how to the above LS ELECTRIC's network system configuration and Enet system configuration, refer to Chap.5 Embedded Communication and "XGB FEnet I/F" of this manual.

Chapter 3 Specifications

3.1 Names and Functions of Each Part

3.1.1 Basic Type

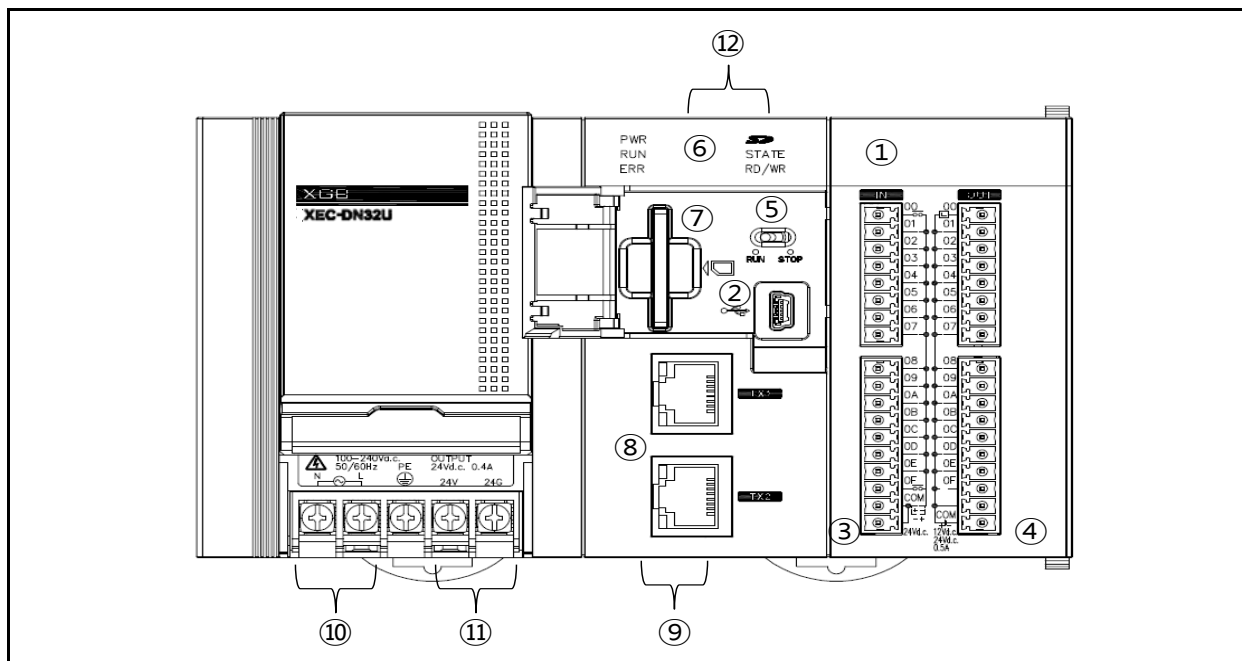

No	Names	Purposes
①	LED for displaying input, output	■ Displays the On/Off status of input, output contacts
②	Connector for PADT	■ Connector(USB 1channel) to access to XG5000
③	Input connector	■ Terminal block receiving the actual input signal
④	Output connector	■ Terminal block outputting the actual output signal
⑤	RUN/STOP mode switch	■ Sets the basic unit's operation mode. <ul style="list-style-type: none"> • STOP → RUN : Program's operation is executed. • RUN → STOP : Program's operation is stopped. (In case of STOP, the remote operation is available.)
⑥	Status display LED	■ Displays the basic unit's operation status. <ul style="list-style-type: none"> • PWR(Red light On) : The power is supplied. • RUN(Green light On) : During RUN mode • ERR(Flickering red light) : Occurrence of errors during operation • STATE(Red light On/flickering Red light): When the SD card is installed, the red light is turned On; when the SD card error occurs, the red light is flickering. • RDWR(Flickering red light) : During SD card Write
⑦	SD card connector	■ Connector with the SD memory card
⑧	connector for the embedded Enet communication	■ Terminal block for the embedded Enet communication
⑨	connector for the embedded communication	■ Terminal block(lower part of the product) for the embedded RS-232C/485 communication
⑩	Power terminal block	■ Terminal block (AC 100 ~ 240V or DC24V) for power supply
⑪	24V output	■ Terminal block with DC 24V output(Not supported on DC type)
⑫	Battery holder	■ Battery holder(upper part of the product)

3.1.2 Analog Type

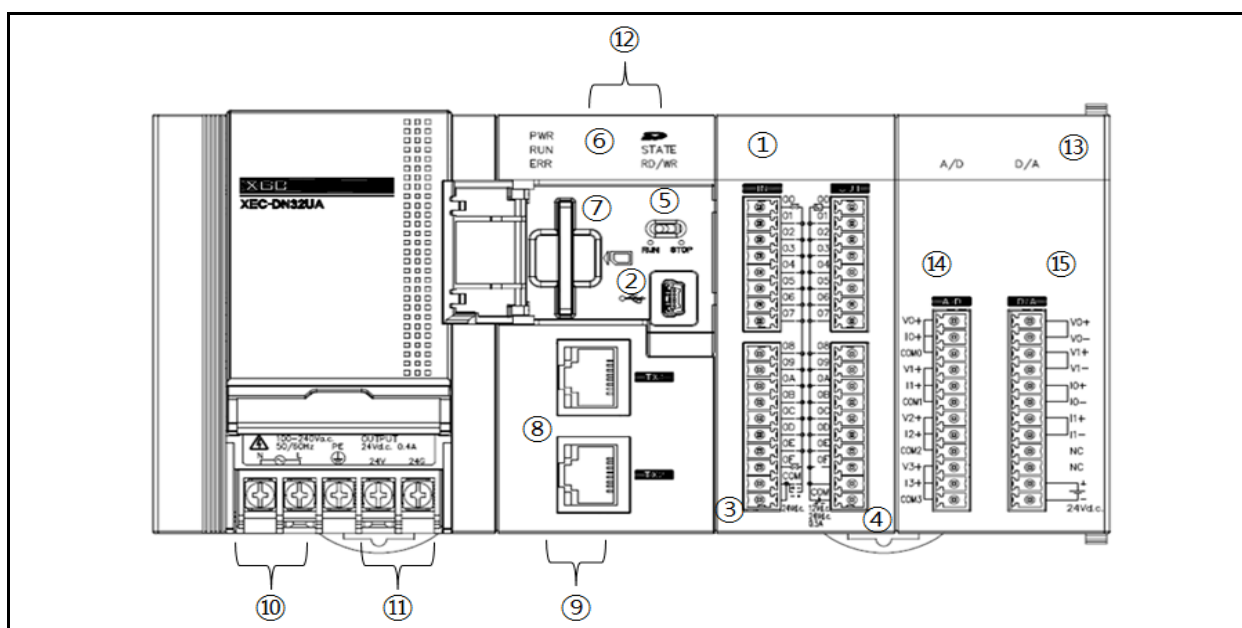

No	Names	Purposes
①	LED for displaying input, output	■ Displays the On/Off status of input, output contacts
②	Connector for PADT	■ Connector(USB 1channel) to access to XG5000
③	Input terminal block	■ Terminal block receiving the actual input signal
④	Output terminal block	■ Terminal block outputting the actual output signal
⑤	RUN/STOP mode switch	■ Sets the basic unit's operation mode. <ul style="list-style-type: none"> • STOP → RUN : Program's operation is executed. • RUN → STOP : Program's operation is stopped. (In case of STOP, the remote operation is available.)
⑥	Status display LED	■ Displays the basic unit's operation status. <ul style="list-style-type: none"> • PWR(Red light On) : The power is supplied. • RUN(Green light On) : During RUN mode • ERR(Flickering red light) : Occurrence of errors during operation • STATE(Red light On/flickering Red light): When the SD card is installed, the red light is turned On; when the SD card error occurs, the red light is flickering. • RD/WR(Flickering red light) : During SD card Write
⑦	SD card connector	■ Connector with the SD memory card
⑧	Terminal block for the embedded Enet communication	■ Terminal block for the embedded Enet communication
⑨	Terminal block for the embedded communication	■ Terminal block(lower part of the product) for the embedded RS-232C/485 communication
⑩	Power terminal block	■ Terminal block (AC 100 ~ 240V or DC24V) for power supply
⑪	24V output	■ Terminal block with DC 24V output(Not supported on DC type)
⑫	Battery holder	■ Battery holder(upper part of the product)
⑬	Analog display LED	■ Displays the operation status of analog input/output. <ul style="list-style-type: none"> • Red light On : During normal operation • Flickering red light : Occurrence of errors • Red light Off : Power OFF or module errors
⑭	AD terminal block	■ Analog input terminal block
⑮	DA terminal block	■ Analog output terminal block

3.1.3 Positioning Type

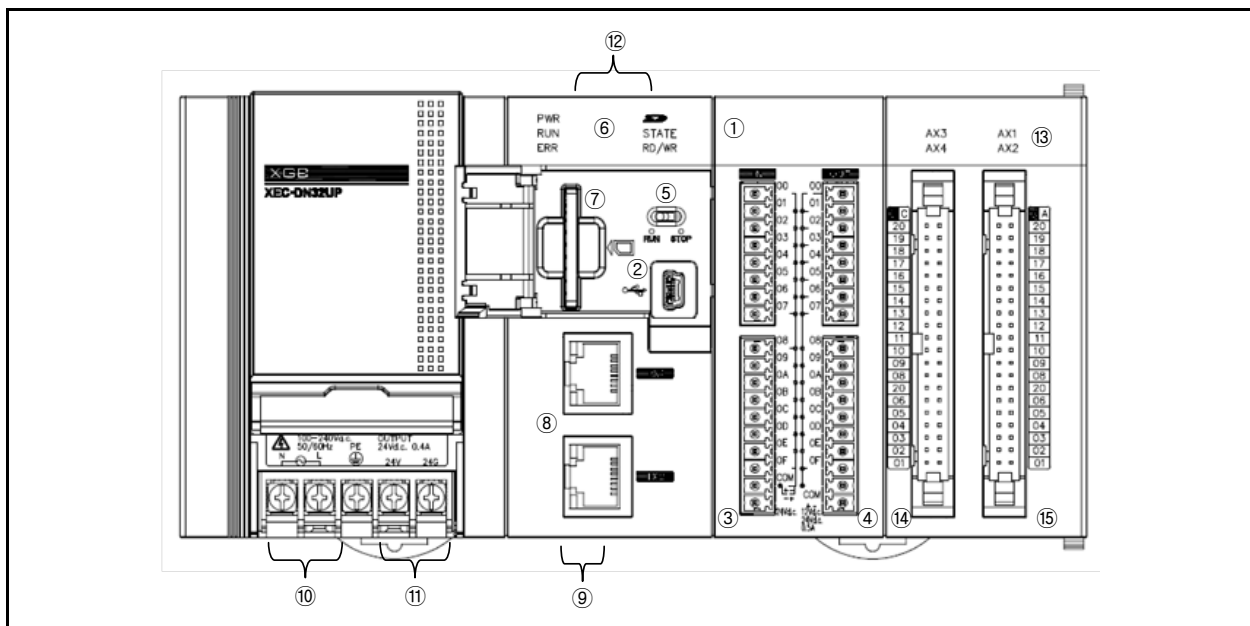

No	Names	Purposes
	LED for displaying input, output	■ Displays the On/Off status of input, output contacts
②	Connector for PADT	■ Connector(USB 1channel) to access to XG5000
③	Input terminal block	■ Terminal block receiving the actual input signal
④	Output terminal block	■ Terminal block outputting the actual output signal
⑤	RUN/STOP mode switch	■ Sets the basic unit's operation mode. • STOP → RUN : Program's operation is executed. • RUN → STOP : Program's operation is stopped. (In case of STOP, the remote operation is available.)
⑥	Status display LED	■ Displays the basic unit's operation status. • PWR(Red light On) : The power is supplied. • RUN(Green light On) : During RUN mode • ERR(Flickering red light) : Occurrence of errors during operation • STATE(Red light On/flickering Red light): When the SD card is installed, the red light is turned On; when the SD card error occurs, the red light is flickering. • RD/WR(Flickering red light) : During SD card Write
⑦	SD card connector	■ Connector with the SD memory card
⑧	Terminal block for the embedded Enet communication	■ Terminal block for the embedded Enet communication
⑨	Terminal block for The embedded communication	■ Terminal block(lower part of the product) for the embedded RS-232C/485 communication
⑩	Power terminal block	■ Terminal block (AC 100 ~ 240V or DC24V) for power supply
⑪	24V output	■ Terminal block with DC 24V output(Not supported on DC type)
⑫	Battery holder	■ Battery holder(upper part of the product)
⑬	LED displaying axial operation	■ Displays the operation status by positioning axes. • Green light On: During the corresponding axial operation • Green light Off: Stop of the corresponding axial operation • Flickering red light: Occurrence of errors from the corresponding axial operation
⑭	I/O connector	■ Connector for external wiring of 3, 4-axis
⑮	I/O connector	■ Connector for external wiring of 1, 2-axis

3.2 General Specifications

No.	Items	Specification	Reference		
1	Ambient Temp.	0 ~ 55 °C	-		
2	Storage Temp.	-25 ~ +70 °C			
3	Ambient humidity	5 ~ 95%RH (Non-condensing)			
4	Storage humidity	5 ~ 95%RH (Non-condensing)			
5	Vibration	Occasional vibration		-	
		Frequency	Acceleration	Pulse width	10 times each direction (X,Y and Z)
		5≤f< 8.4Hz	-	3.5mm	
		8.4≤f≤150Hz	9.8m/s ² (1G)	-	
		Continuous vibration			
		Frequency	Acceleration	Pulse width	
		5≤f< 8.4Hz	-	1.75mm	
8.4≤f≤150Hz	4.9m/s ² (0.5G)	-			
6	Shocks	<ul style="list-style-type: none"> • Peak acceleration : 147 m/s²(15G) • Duration : 11ms • Pulse wave type : Half-sine (3 times each direction per each axis) 		IEC61131-2	
7	Impulse noise	Square wave impulse noise	AC: ±1,500 V DC: ±900 V		
		Electrostatic discharge	Voltage: 4kV (Contact discharge)		
		Radiated electromagnetic field noise	80 ~ 1,000MHz, 10 V/m		
		Fast transient /Burst noise	Classifi- cation Voltage	Power supply 2kV	Digital/Analog Input/Output, Communication Interface 1kV
8	Operation ambience	Free from corrosive gases and excessive dust		-	
9	Altitude	Less than 2,000m			
10	Pollution degree	Less than 2			
11	Cooling method	Air-cooling			

Notice

1) IEC (International Electrotechnical Commission)

: An international civil community that promotes international cooperation for standardization of electric/ electro technology, publishes international standard and operates suitability assessment system related to the above.

2) Pollution Degree

: An index to indicate the pollution degree of used environment that determines the insulation performance of the device. For example, pollution degree 2 means the state to occur the pollution of non-electric conductivity generally, but the state to occur temporary electric conduction according to the formation of dew.

3.3 Power specifications

This section describes the high performance XGB PLC basic unit's power specifications.

Items		Specification				
		AC power		DC power		
Input	Input voltage range	AC85V ~ AC264V		DC24V		
	Rated input voltage	AC100V ~ AC240V		DC19.2~28.8V		
	Input frequency	50/60 ± 3 Hz(47 ~ 63 Hz)		-		
	input current	1.2A or less		1.6A or less		
		0.6A or less				
	Inrush current	120Apeak or less		100Apeak or less		
	leakage current	1mA or less		3mA or less		
	Efficiency	65% or more		65% or more		
Permitted momentary power failure	10ms or less		7ms or less			
Output	Output voltage	voltage	Output voltage	current	Output voltage	
			Ripple rate		Ripple rate	
		+5V	4.90~5.15V	5A	4.90~5.15V	5A
		+24V	21.1~26.9V	0.4A	-	-
	Ripple & Noise	voltage	ripple	noise	ripple	noise
		+5V	100mVpp or less	200mVpp or less	100mVpp or less	200mVpp or less
		+24V	400mVpp or less		-	
	Protecting overcurrent	+5V	5.5A or more		5.5A or more	
+24V		0.44A or more		-		

* For protection of the power supply, you are recommended to use the power supply with the maximum of 4A fuse.

Notice

(1) Allowable instantaneous interruption time

It is the time to maintain the normal output voltage(normal operation) on the condition that the input voltage of AC110/220V is lower than the rating (AC85/170V).

(2) Over-current Protection

(a) When the voltage exceeding the standard is applied to the circuit of DC5V, DC24V, over-current protection device interrupts the circuit and stops the system.

(b) If over-current occurs, after removing the causes such as shortage of current capacity, short circuit, etc., restart the system.

(3) Over-voltage Protection

When the voltage exceeding the standard is applied to the circuit of DC5V, over-voltage protection device interrupts the circuit and stops the system.

(4) Use a UL certified product for the power supply.

Use a power supply that meets Class 2 or LVLC (Limited voltage Limited circuit).

3.3.1 Consumption current

Type	Model	Consumption current (Unit : mA)
Main unit	XEC-DN32U/(DC)	700
	XEC-DR28U/(DC)	990
	XEC-DN32UP/(DC)	1250
	XEC-DR28UP/(DC)	1550
	XEC-DN32UA/(DC)	780
	XEC-DR28UA/(DC)	1040
Expansion I/O module	XBE-DC32A	50
	XBE-DC16A/B	40
	XBE-DC08A	20
	XBE-RY16A	440
	XBE-RY08A/B	240
	XBE-TN32/16/08A	80/50/40
	XBE-DR16A	250
	XBE-TP32/16/08A	80/50/40
Expansion Special module	XBF-AD04A	120
	XBF-AD08A	105
	XBF-AH04A	120
	XBF-DV04A	110
	XBF-DC04A	110
	XBF-RD04A	100
	XBF-RD01A	100
	XBF-TC04S	100
	XBF-PD02A	500
	XBF-HO02A	270
	XBF-HD02A	330
	XBF-AD04C	105
	XBF-DC04C	70
	XBF-DV04C	70
	XBF-TC04RT	120
	XBF-TC04TT	120
	XBF-LD02S	110
Expansion Communication module	XBL-C21A	110
	XBL-C41A	110
	XBL-EMTA	190
	XBL-EIMT/F/H	280/670/480
	XBL-EIPT	400
	XBL-CMEA	150
	XBL-CSEA	150
	XBL-PMEC	300
	XBL-PSEA	230
XBL-DSEA	100	

3.3.2 Calculation Example of Consumption Current/Voltage

Calculate the consumption current and configure the system not to exceed the output current capacity of main unit. Refer to 3.3.1 for each module's consumption current

(1) XGB PLC configuration example 1

Consumption of current/voltage is calculated as follows.

Type	Model	Unit No.	Internal 5V consumption current (Unit : mA)	Remark
Main unit	XEC-DN32U	1	700	In case all contact points are On. (Maximum consumption current)
Expansion module	XBE-DC32A	2	50	
	XBE-TN32A	2	80	
	XBF-AD04A	1	120	All channel is used. (Maximum consumption current)
	XBF-DC04A	1	110	
	XBL-C21A	1	110	
Consumption current	1,300mA		-	
Consumption voltage	6.5W		1.3A x 5V = 6.5W	

In case system is configured as above, since 5V consumption current is total 1,300 mA and 5V output of XGB 32 points main unit is maximum 5A, normal system configuration is available.

(2) XGB PLC configuration example 2

Type	Model	Unit No.	Internal 5V consumption current (Unit : mA)	Remark
Main unit	XEC-DN32U	1	700	In case all contact points are On. (Maximum consumption current)
Expansion module	XBE-DR16A	2	250	
	XBE-RY16A	2	440	
	XBF-AD04A	2	120	All channel is used. (Maximum consumption current)
	XBL-C21A	1	110	
Consumption current	2,430mA		-	
Consumption voltage	12.15W		2.43 * 5V = 12.15W	

In case system is configured as above, since 5V consumption current is total 2,430 mA and 5V output of XGB 32 points main unit is maximum 5A, normal system configuration is available.

3.4 Battery

3.4.1 Battery specifications

Items	Specifications
Nominal voltage / current	DC 3.6V / 800 mAh
Warranty term	3 years(at room temperature)
Purpose	Program and data backup, RTC operation during the blackout
Backup time	3years
Specifications	Lithium battery, 3.6V
Appearance Size (mm)	φ14.5 X 26 mm

3.4.2 Instruction for Use

- (1) Do not apply heat or solder electrode (It may cause a battery's life-shortening)
- (2) Do not measure voltage with a tester or short-circuit (It may be the cause of a fire.)
- (3) Do not disassemble the battery.

3.4.2 Battery Life

A battery's life may be different depending on the conditions of blackout time, service temperature, etc. When the voltage of a battery gets lower, the basic unit sends 'Warning on Battery's Voltage Drop'. The situation also can be checked through the basic unit's error LED and XG5000's error message.
(Warning on a battery's voltage drop occurs within 10 second after detaching the battery)
In the system with routine inspection, you can take measures after the fact since the battery works normally for substantial amount of time even after the warning on a battery's voltage drop occurred.

3.4.3 How to replace a battery

The battery used for backup in case of power failure of programs and data requires the periodic replacement. Although the battery is removed, the program and data electrostatic holding data are maintained by the Super Capacitor for about 30 minutes, however, it should be replaced as soon as possible.

The procedures to replace the battery are as below.

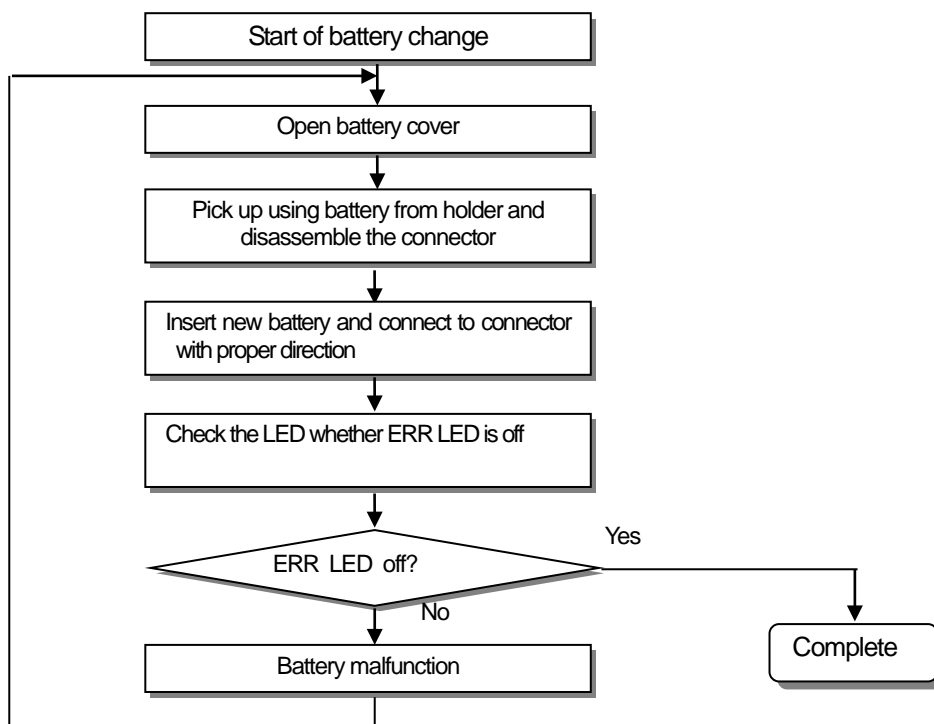

3.5 Performance specifications

3.5.1 Common performance specifications for CPU

The high performance XGB basic unit's common performance specifications for CPU are as below.

Items	Specifications						Remark
	XEC-DN(P) 32U/(DC)	XEC-DR 28U/(DC)	XEC-DN 32UA/(DC)	XEC-DR 28UA/(DC)	XEC-DN 32UP/(DC)	XEC-DR 28UP/(DC)	
Program control metho	Cyclic execution of stored program, Time-driven interrupt, Process-driven interrupt						
I/O control method	Batch processing by simultaneous scan (Refresh method), Directed by program instruction						
Program language	Ladder Diagram, Instruction List						
No. of instruction	Operator	18					
	Basic function	136 + Floating-point Arithmetic Functions					
	Basic function block	43					
	Special function block	Each special module has own special function blocks					
Processing speed (Basic instruction)	60ns/step						
Program memory	384KB						
Max. I/O points	352points	348points	352points	348points	352points	348points	main + 10 expansions
Data area	Symbolic variable(A)	64KB (Retain setting available)					
	Input variable(I)	2KB					
	Output variable(Q)	2KB					
	Direct variable	M	32KB (Retain setting available)				-
		R	32KB * 2blocks				-
		W	64KB				Same area with R
	Flag variable	F	4KB				System flag
		K	16KB				Keep relay
		L	8KB				Link relay
		U	768 Byte				Analog data refresh area
N		20KB				P2P parameter	
Flash area	4blocks (128Kbyte)					Using R device	
Timer	No limit in points (Time range: 0.001~ 4,294,967.295 s)						
Counter	No limit in points (Counter range: 64 bit range)						
Total program	256						
Initial task	Initial task	1					
	Cyclic task	Max 16					
	I/O task	Max 8					
	Internal device task	Max 16					
	High Speed Counter task	Max 8					
Operation mode	RUN, STOP, DEBUG						
Self-diagnosis function	Detects errors of scan time, memory, I/O and power supply						
Program port	USB 1 channel						
Back-up method	Latch area setting in basic parameter						
Internal consumption current	700mA	990mA	780mA	1,040mA	1,250mA	1,550mA	
Weight	571g	630g	683g	732g	673g	722g	

Chapter 3 Specifications

Items		Specifications						Note	
		XEC-DN 32U/(DC)	XEC-DR 28U/(DC)	XEC-DN 32UA/(DC)	XEC-DR 28UA/(DC)	XEC-DN 32UP/(DC)	XEC-DR 28UP/(DC)		
Built-in function	PID control	Control by instruction, auto-tuning, PWM output, Forced output, Operation scan time setting, Antiwindup, Delta MV, PV tracking, Hybrid operation, Cascade operation							
	Serial	Protocol	Dedicated protocol, Modbus protocol User defined protocol , LS bus(inverter protocol)						Embedded00 P2P:01
		Channel	RS-232C 1 port and RS-485 1 port						
	Ethernet	Transfer spec	Cable: 100Base-TX Speed: 100Mbps Auto-MDIX ^{*1} IEEE 802.3						
		Topology	Line, star						
		Diagnosis	Module information, service condition						
		Protocol	XGT dedicated Modbus TCP/IP user define frame						Embedded01 P2P:02 High-speed link:01
	Service	P2P, High Speed link, Remote connection							
	Datalog	Group	Max 10 group						
		Data set	32 per group						
		Extension	csv file						
		File size	Max 16Mbyte						
		SD memory type	SD,SDHC type (Recommand: SanDisk,Transcend)						
		Memory size	Max 16GB						
	File system	FAT32							
Built-in function	High Speed Counter	Performance	1-phase : 100 kHz 8 channels 2-phase : 50 kHz 4 channels						
		Counter mode	4 counter modes are supported based on input pulse and INC/DEC method • 1 pulse operation Mode : INC/DEC count by program • 1 pulse operation Mode : INC/DEC count by phase B pulse input • 2 pulse operation Mode : INC/DEC count by input pulse • 2 pulse operation Mode : INC/DEC count by difference of phase						
		Function	• Internal/external preset • Latch counter • Compare output • No. of rotation per unit time						
		Pulse catch	50μs 8point(%IX0.0.8 ~ %IX0.0.15)						
		External point Interrupt	50μs 8point(%IX0.0.8 ~ %IX0.0.15)						
		Input filter	1,3,5,10,20,70,100ms						

*1 Auto-MDIX(Automatic medium-dependent interface crossover) : It is the function to automatically detect whether the cable connected to the Ethernet port is peer-to-peer(straight) or cross cable

Notice

Even in the same program, there may be a difference in the amount of memory used depending on the base unit MPU chip performance and compilation method.

3.5.2 Specifications for Embedded Positioning

The specifications for Embedded Positioning are as below.

Items		Specifications	Remark
Built-in function	Positioning	Basic Function No. of control axi: 4axis Control Method:Position, Speed, Speed/Position, Feed Control Control Unit: Pulse ,mm, inch, degree Positioning Data: Each axis can have up to 400 data (Step number:1~400) Operation pattern: End, Keep, Continuous Operation method: Singular, Repeat	Available On UP type
		interpolation 2/3/4 axis linear interpolation 2 axis circular interpolation 3 axis helical interpolation	
		Positioning Method: Absolute/Incremental method Address range: 2,147,483,648~2,147,483,647 Speed: Max 2Mpps(1~2,000,000pps) Acc /Dec process: Trapezoid type, S-type	
		Homing method DOG+HOME(Off), DOG+HOME(On), Upper limit + HOME,DOG, High speed, Upper/Lower limit, HOME	
		Manual operation Jog operation, MPG operation, Inching operation	
		Encoder input Line drive(RS-422A) input 1Channel(Max 200kpps)	

3.5.3 Specifications for Embedded Analog

The specifications for Embedded Analog are as below.

Items		Specifications		Remark		
Built-in function	Analog input	Channels	4channels (current/voltage)		Available On Analog	
		Specification	Input Range	Voltage: 1~5V, 0~5V, 0~10V, -10~10V Current: 4~20mA, 0~20mA		
				Current input or Voltage input can be selected through the external terminal wiring setting.		
			Input resistance	1M Ω or more(voltage input), 250 Ω (current input)		
			Max.Resolution	1/16000		
	0.250mV (1 ~ 5V) 0.3125mV (0 ~ 5V) 0.625mV (0 ~ 10V) 1.250mV (\pm 10V)	1.0 μ A (4 ~ 20mA)				
		1.25 μ A (0 ~ 20mA)				
		Accuracy	\pm 0.2% or less (When ambient temperature is 25 $^{\circ}$ C) \pm 0.3% or less (When ambient temperature is 0 ~ 55 $^{\circ}$ C)			
	Analog output	Channels	Voltage 2 channels ,Current 2 channels			
		Specification	Output Range	Voltage: 1~5V, 0~5V, 0~10V, -10~10V Current: 4~20mA, 0~20mA		
Output ranges are set in user program or I/O parameter per each channel.						
Load resistance			1M Ω or more(voltage output), 600 Ω or less(current output)			
Max.Resolution			1/16000			
	0.250mV (1 ~ 5V) 0.3125mV (0 ~ 5V) 0.625mV (0 ~ 10V) 1.250mV (\pm 10V)	1.0 μ A (4 ~ 20mA)				
		1.25 μ A (0 ~ 20mA)				
Accuracy		\pm 0.2% or less (When ambient temperature is 25 $^{\circ}$ C) \pm 0.3% or less (When ambient temperature is 0 ~ 55 $^{\circ}$ C)				

Chapter 4 Installation and wiring

4.1 Parameter & Operation data



Danger

▶ Please design protection circuit at the external of PLC for entire system to operate safely because an abnormal output or an malfunction may cause accident when any error of external power or malfunction of PLC module.

(1) It should be installed at the external side of PLC to emergency stop circuit, protection circuit, interlock circuit of opposition action such as forward /reverse operation and interlock circuit for protecting machine damage such as upper/lower limit of positioning.

(2) If PLC detects the following error, all operation stops and all output is off.

(Available to hold output according to parameter setting)

(a) When over current protection equipment or over voltage protection operates

(b) When self diagnosis function error such as WDT error in PLC CPU occurs

▶ When error about IO control part that is not detected by PLC CPU, all output is off.

Design Fail Safe circuit at the external of PLC for machine to operate safely. Refer to 4.1.1 Fail Safe circuit.

(1) Because of error of output device, Relay, TR, etc., output may not be normal. About output signal that may cause the heavy accident, design supervisory circuit to external.

▶ When load current is more than rating or over current by load short flows continuously, danger of heat, fire may occur so design safety circuit to external such as fuse.

▶ Design for external power supply to be done first after PLC power supply is done. If external power supply is done first, it may cause accident by misoutput, misoperation.

▶ In case communication error occurs, for operation status of each station, refer to each communication manual.

▶ In case of controlling the PLC while peripheral is connected to CPU module, configure the interlock circuit for system to operate safely. During operation, in case of executing program change, operation status change, familiarize the manual and check the safety status. Especially, in case of controlling long distance PLC, user may not response to error of PLC promptly because of communication error or etc.

Limit how to take action in case of data communication error between PLC CPU and external device adding installing interlock circuit at the PLC program.

 **Danger**

- ▶ Don't close the control line or communication cable to main circuit or power line. Distance should be more than 100mm.
It may cause malfunction by noise.

- ▶ In case of controlling lamp load, heater, solenoid valve, etc. in case of Off -> On, large current (10 times of normal current) may flows, so consider changing the module to module that has margin at rated current.

- ▶ Process output may not work properly according to difference of delay of PLC main power and external power for process (especially DC in case of PLC power On-Off and of start time.
For example, in case of turning on PLC main power after supplying external power for process, DC output module may malfunction when PLC is on, so configure the circuit to turn on the PLC main power first
Or in case of external power error or PLC error, it may cause the malfunction.

- ▶ Not to lead above error to entire system, part causing breakdown of machine or accident should be configured at the external of PLC

Chapter 4 Installation and Wiring

4.1.1 fail safe circuit

(1) example of system design (When ERR contact point of power module is not used)

In case of AC

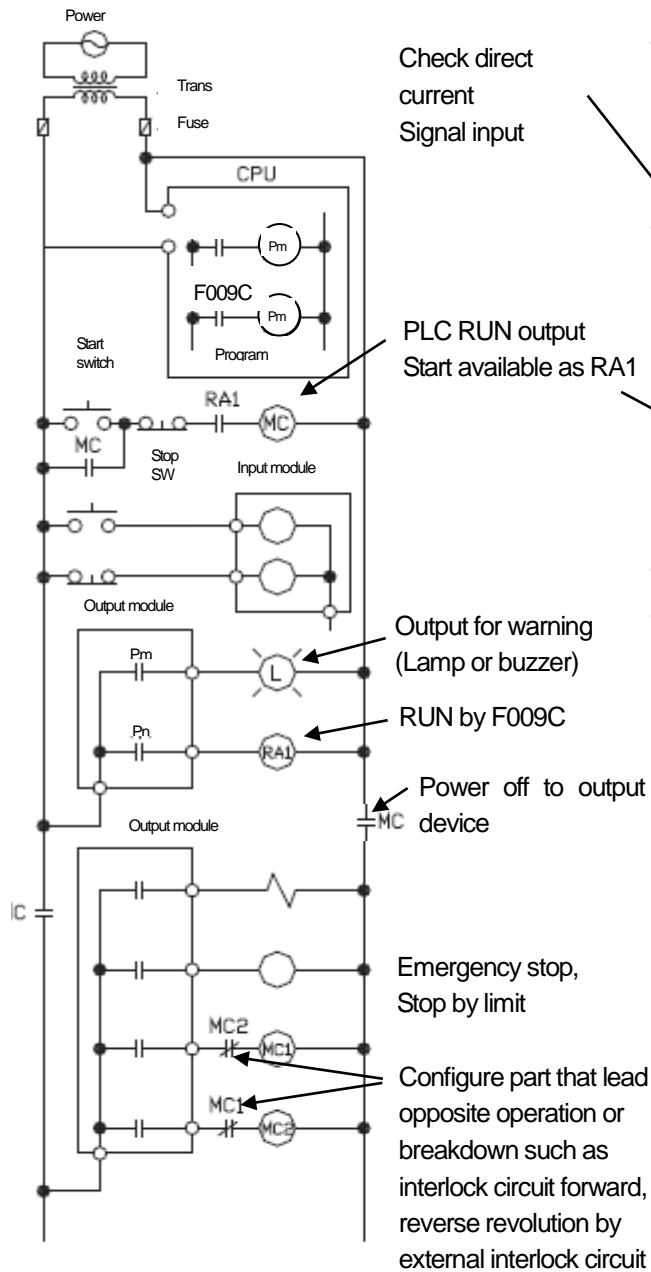

Start sequence of power. In case of AC

- (1) Turn on power
- (2) Run CPU.
- (3) Turn on start switch
- (4) Output device runs by program through magnetic contactor (MC) [On]

In case of AC . DC

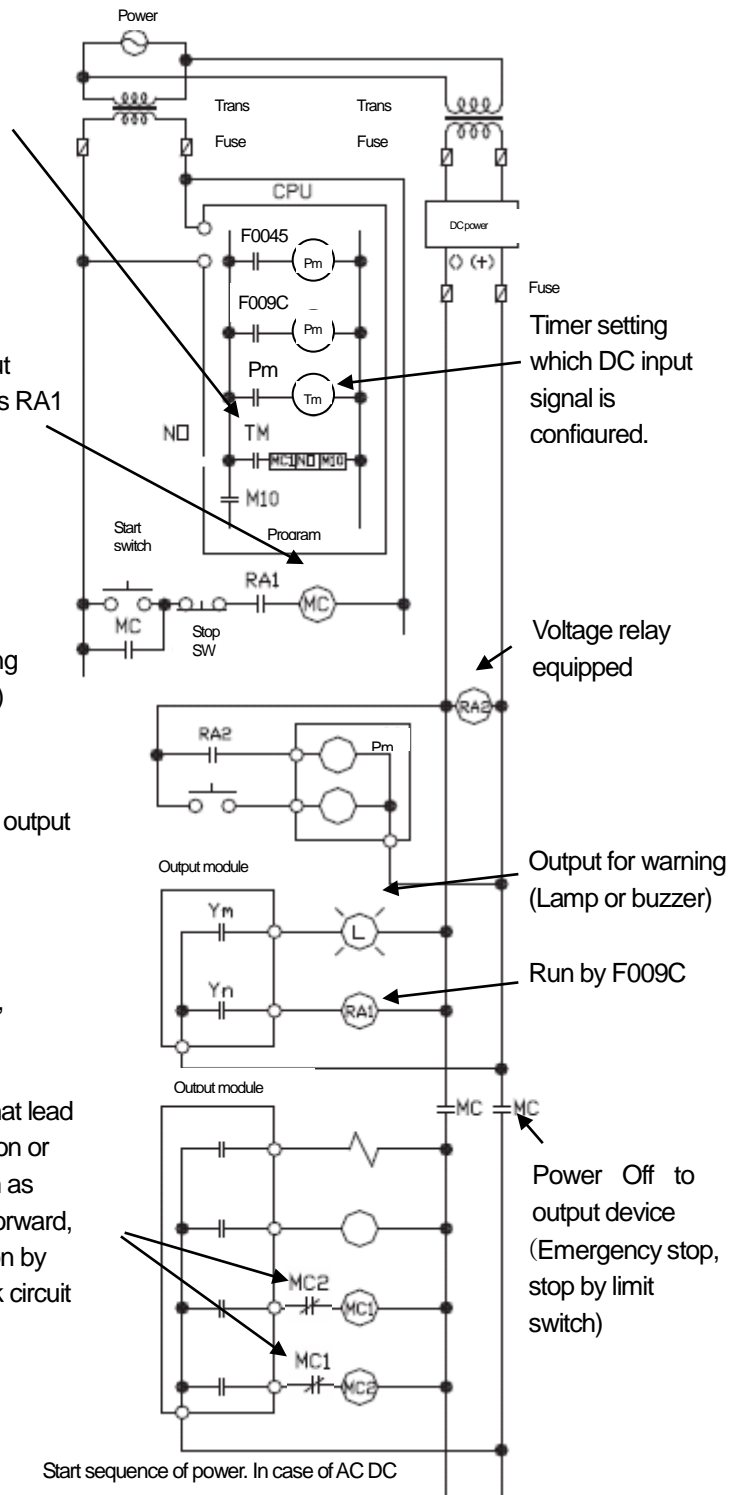

Start sequence of power. In case of AC DC

- (1) Run CPU after power is on
- (2) Turn on RA2 as DC power on
- (3) Turn on timer after DC power is stable.
- (4) Turn on start switch
- (5) Output device runs by program through magnetic contactor (MC) [On]

(2) Fail Safe Measures in case of PLC failures

Failures of the PLC CPU and memory are detected by self-diagnosis but if there are some problems with I/O control part, etc, the failure may not be detected from the CPU. In this case, it can be different depending on the failure status, all contacts may be On or Off so normal operation or safety of the controlled subject cannot be guaranteed.

We have done our best to assure quality but in case there are some problems with the PLC, please configure the fail safe circuit on the outside to prevent damage of the equipment or accident due to some cause. The below is the example of system configuration with the fail sage circuit.

<System example>

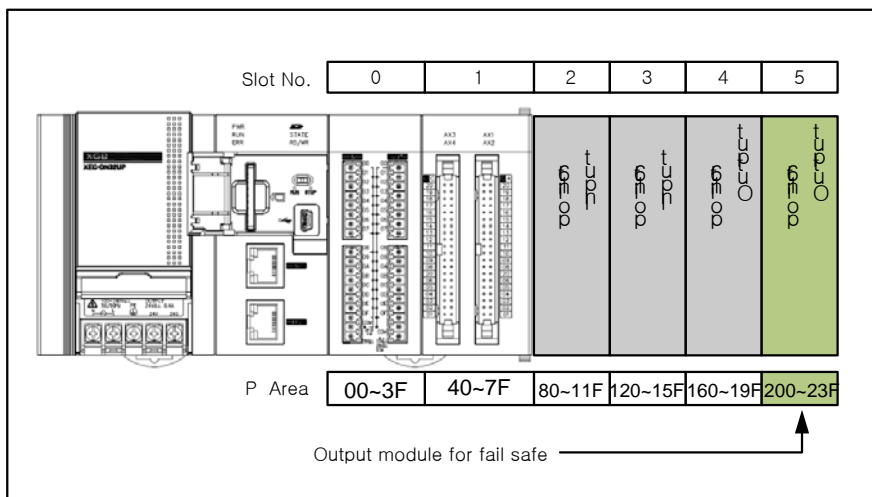

* Equip output module for fail safe to last slot of system.

[Fail safe circuit example]

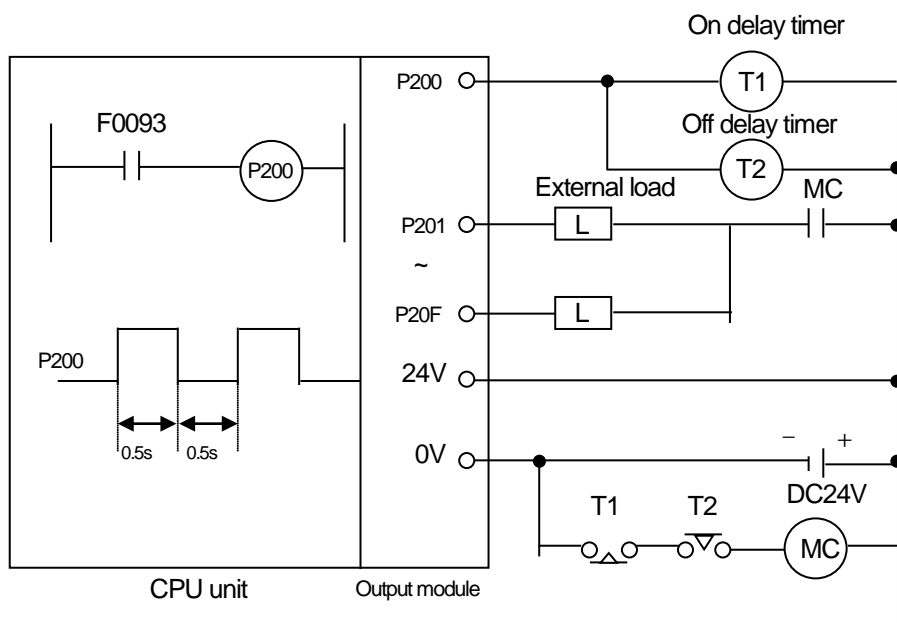

Since P200 turn on/off every 0.5s, use TR output.

Chapter 4 Installation and Wiring

4.1.2 PLC heat calculation

(1) Power consumption of each part

(a) Power consumption of module

The power conversion efficiency of power module is about 70% and the other 30% is gone with heat; 3/7 of the output power is the pure power consumption. Therefore, the calculation is as follows.

- $W_{pw} = 3/7 \{ (I_{5V} \times 5) + (I_{24V} \times 24) \}$ (W)

I_{5V} : power consumption of each module DC5V circuit (internal current consumption)

I_{24V} : the average current consumption of DC24V used for output module
(current consumption of simultaneous On point)

If DC24V is externally supplied or a power module without DC24V is used, it is not applicable.

(b) Sum of DC5V circuit current consumption

The DC5V output circuit power of the power module is the sum of power consumption used by each module.

- $W_{5V} = I_{5V} \times 5$ (W)

(c) DC24V average power consumption (power consumption of simultaneous On point)

The DC24V output circuit's average power of the power module is the sum of power consumption used by each module.

- $W_{24V} = I_{24V} \times 24$ (W)

(d) Average power consumption by output voltage drop of the output module (power consumption of simultaneous On point)

- $W_{out} = I_{out} \times V_{drop} \times \text{output point} \times \text{simultaneous On rate}$ (W)

I_{out} : output current (actually used current) (A)

V_{drop} : voltage drop of each output module (V)

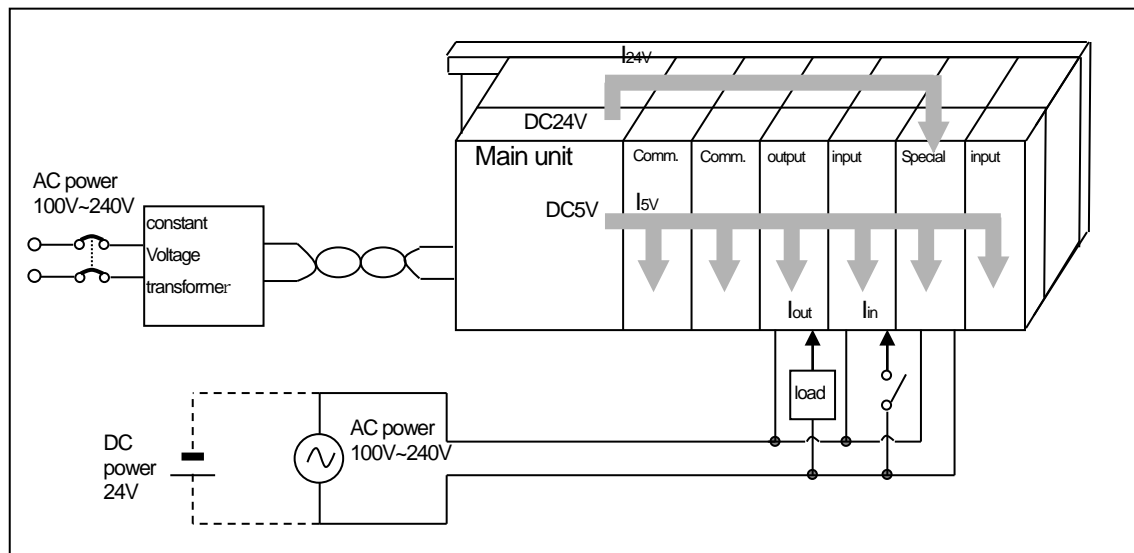

(e) Input average power consumption of input module

(power consumption of simultaneous On point)

- $W_{in} = I_{in} \times E \times$ input point \times simultaneous On rate (W)

I_{in} : input current (root mean square value in case of AC) (A)

E : input voltage (actually used voltage) (V)

(f) Power consumption of special module power assembly

- $W_s = I_{5V} \times 5 + I_{24V} \times 24 + I_{100V} \times 100$ (W)

The sum of power consumption calculated by each block is the power consumption of the entire PLC system.

- $W = W_{PW} + W_{5V} + W_{24V} + W_{out} + W_{in} + W_s$ (W)

Calculate the heats according to the entire power consumption(W) and review the temperature increase within the control panel.

The calculation of temperature rise within the control panel is displayed as follows.

$$T = W / UA \text{ [}^\circ\text{C]}$$

W : power consumption of the entire PLC system (the above calculated value)

A : surface area of control panel [m^2]

U : if equalizing the temperature of the control panel by using a fan and others : 6

If the air inside the panel is not ventilated : 4

If installing the PLC in an air-tight control panel, it needs heat-protective(control) design considering the heat from the PLC as well as other devices. If ventilating by vent or fan, inflow of dust or gas may affect the performance of the PLC system.

Chapter 4 Installation and Wiring

4.2 Attachment/Detachment of Modules

Here describes about basic parameter of embedded positioning.

4.2.1 Attachment/Detachment of modules

Caution in handling

Use PLC in the range of general specification specified by manual.

In case of usage out of range, it may cause electric shock, fire, malfunction, damage of product.



Remark

- ▶ Module must be mounted to hook for fixation properly before its fixation.
The module may be damaged from over-applied force. If module is not mounted properly, it may cause malfunction.
- ▶ Do not drop or impact the module case, terminal block connector.
- ▶ Do not separate PCB from case.

(1) Equipment of module

- Eliminate the Extension Cover at the product.
- Push the product and connect it in agreement with Hook For Fixation of four edges and Hook For Connection at the bottom.
- After connection, push down the Hook For Fixation and fix it completely.

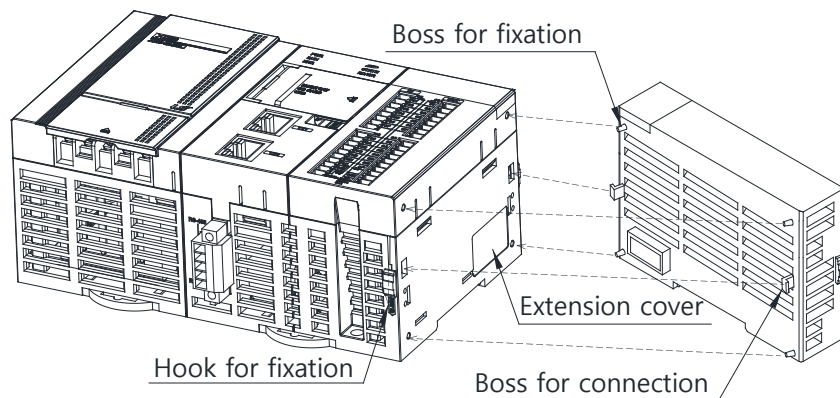

(2) Detachment of module

- Push up the Hook For Disconnection, and then detach the product with two hands.
(Do not detach the product by force)



Remark

- ▶ When separating module, do not apply excessive force. If so, hook may be damaged.

(3) Installation of module

XGB PLC has a hook for DIN rail (rail width: 35mm) so that can be installed at DIN rail.

(a) In case of installing at DIN rail

- Pull the hook as shown below for DIN rail at the bottom of module and install it at DIN rail
- Push the hook to fix the module at DIN rail after installing module at DIN rail
- Install a stopper at both ends of the product to prevent damage to the product due to vibration.

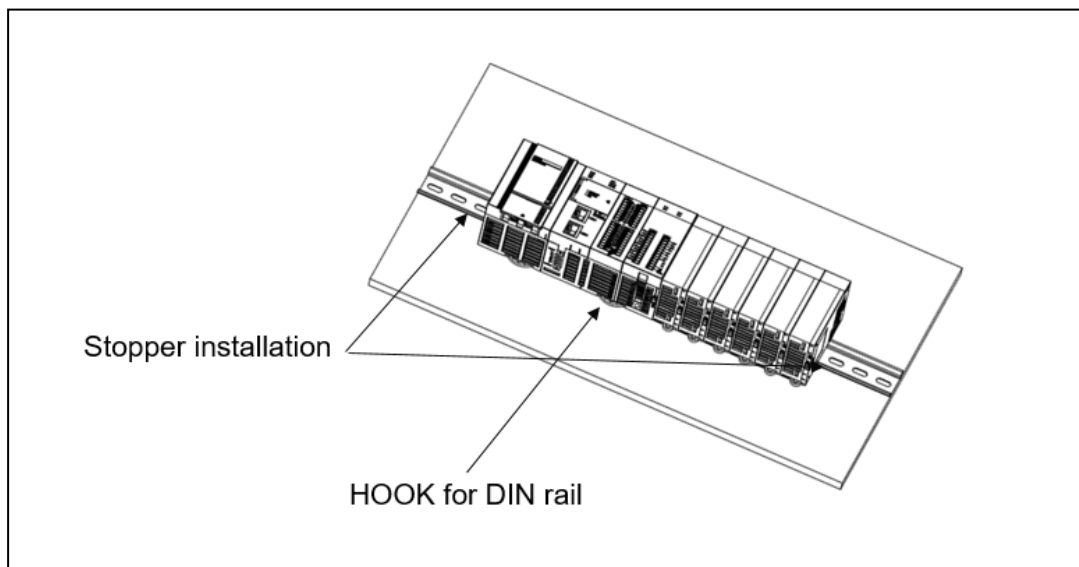

(b) In case of installing at panel

- You can install XGB compact type main unit onto a panel directly using screw hole
- Use M4 type screw to install the product onto a panel.

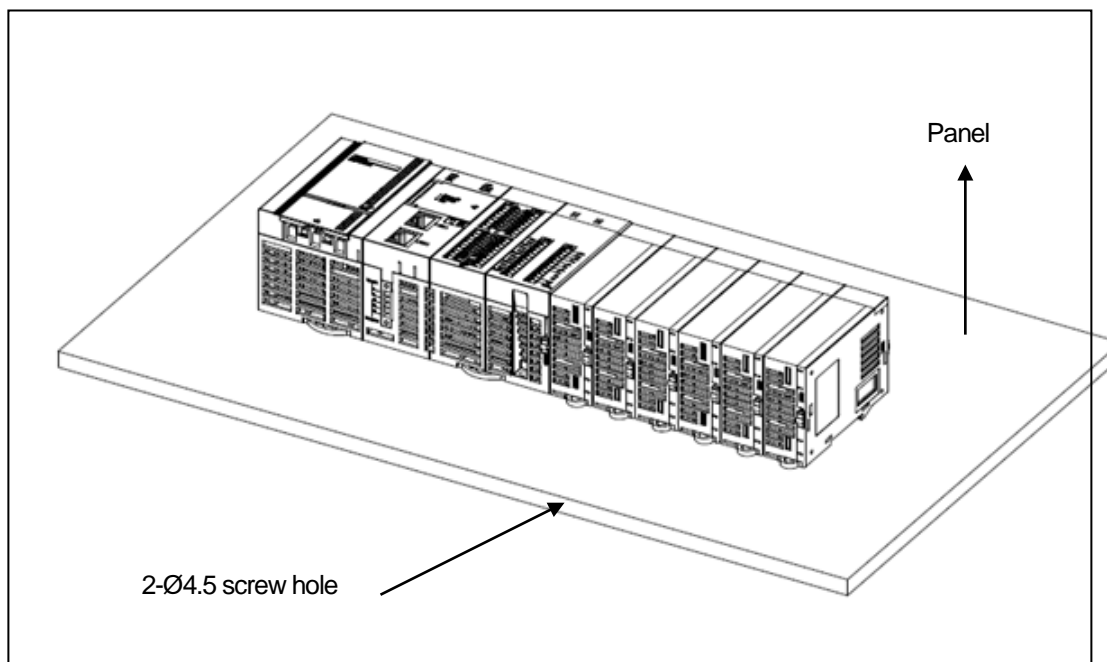

Chapter 4 Installation and Wiring

(4) Module equipment location

Keep the following distance between module and structure or part for ventilation, easy detachment and attachment.

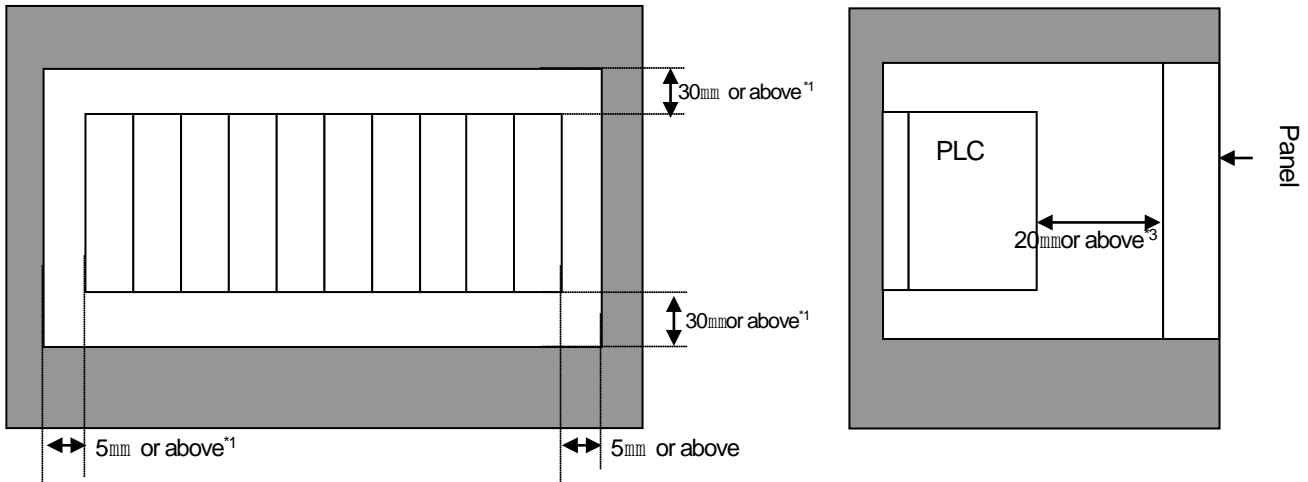

*1 : In case height of wiring duct is less than 50 mm (except this 40mm or more)

*2 : In case of equipping cable without removing near module, 20mm or more

*3 : In case of connector type, 20mm or above

(5) Module equipment direction

(a) For easy ventilation, install as shown below.

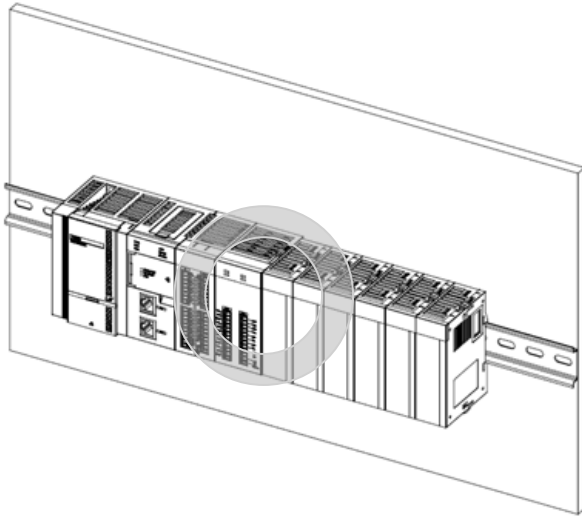

(b) Don't install as shown below.

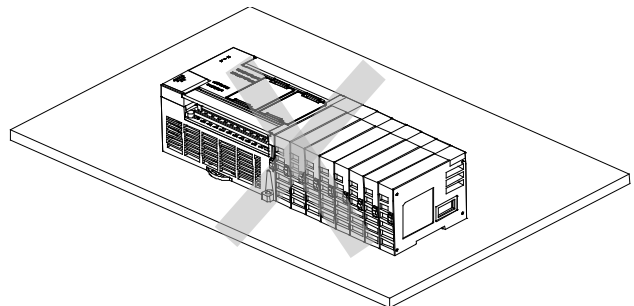
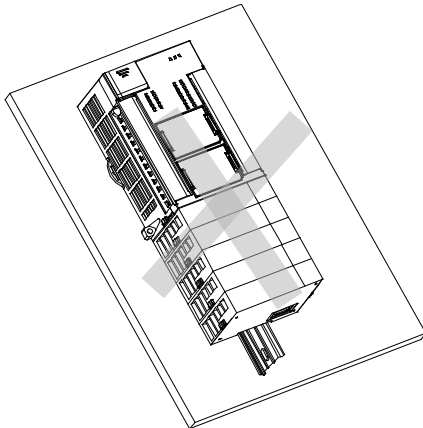

(6) Distance with other device

To avoid radiation noise or heat, keep the distance between PLC and device (connector and relay) as far as the following figure.

Device installed in front of PLC: 100 mm or more

Device installed beside PLC: 50 mm or more

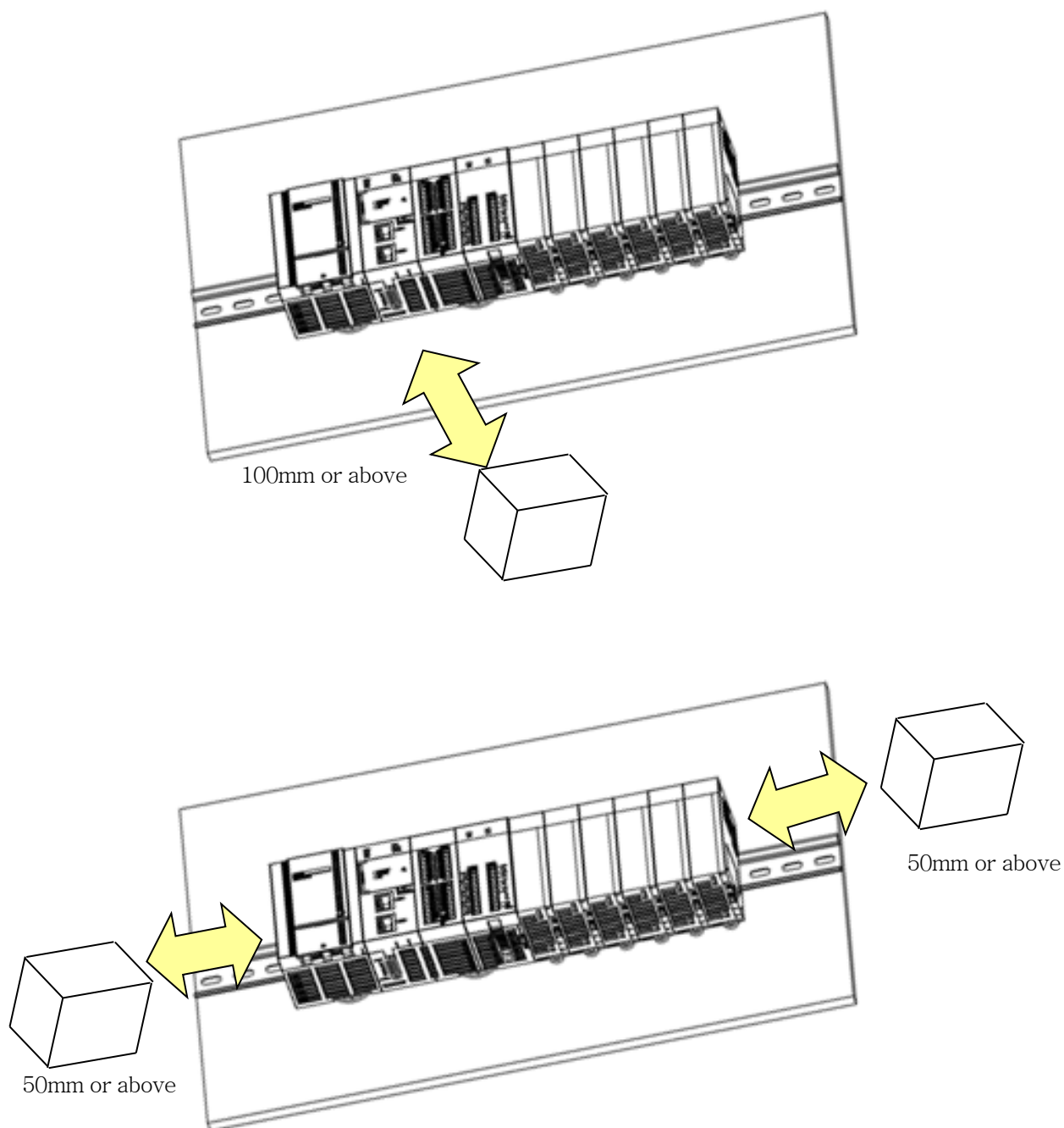

Chapter 4 Installation and Wiring

4.2.2 Caution in handling

Here describes caution from open to install

- Don't drop or impact product.
- Don't disassemble the PCB from case. It may cause an error.
- In case of wiring, make sure foreign substance not to enter upper part of module. If it enters, eliminate it.

(1) Caution in handling IO module

It describes caution in handling IO module.

(a) Recheck of IO module specification

For input module, be cautious about input voltage, for output module, if voltage that exceeds the max. open/close voltage is induced, it may cause the malfunction, breakdown or fire.

(b) Used wire

When selecting wire, consider ambient temp, allowed current and minimum size of wire is AWG22(0.3mm²) or above.

(c) Environment

In case of wiring IO module, if device or material that induce high heat is too close or oil contacts wire too long time, it may cause short, malfunction or error.

(d) Polarity

Before supplying power of module which has terminal block, check the polarity.

(e) Wiring

- In case of wiring IO with high voltage line or power line, induced obstacle may cause error.
- Let no cable pass the IO operation indication part (LED).
(You can't discriminate the IO indication.)
- In case induced load is connected with output module, connect the surge killer or diode load in parallel. Connect cathode of diode to + side of power.

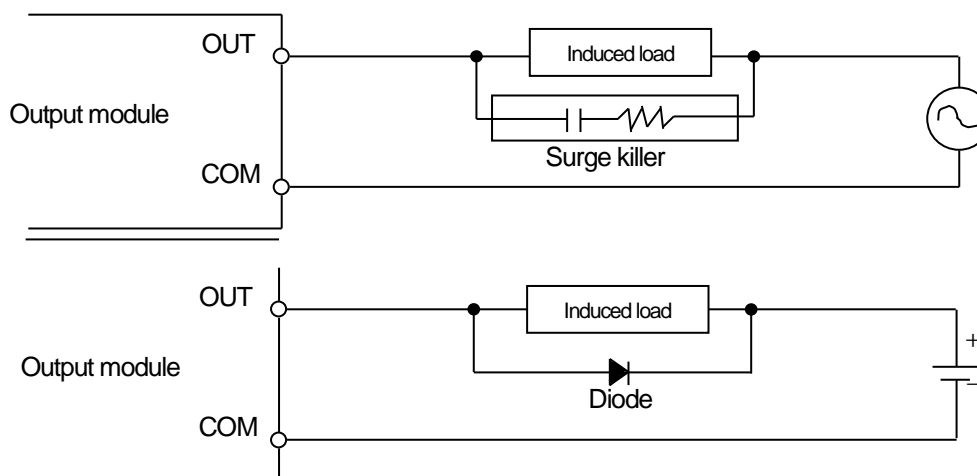

(f) Terminal block

Check close adhesion status. Let no foreign material enter into PLC when wiring terminal block or processing screw hole as it may cause malfunction, it may cause malfunction.

(g) Don't impact IO module or don't disassemble the PCB from case.

4.3 Wire

In case using system, it describes caution about wiring.



Danger

- ▶ When wiring, cut off the external power.
- ▶ If all power is cut, it may cause electric shock or damage of product.
- ▶ In case of flowing electric or testing after wiring, equip terminal cover included in product. If not, it may cause electric shock.



Remark

- ▶ Do D type ground (type 3 ground) or above dedicated for PLC for FG and LG terminal. It may cause electric shock or malfunction.
- ▶ When wiring module, check the rated voltage and terminal array and do properly.
If rating is different, it may cause fire, malfunction.
- ▶ For external connecting connector, use designated device and solder.
If connecting is not safe, it may cause short, fire, malfunction.
- ▶ For screwing, use designated torque range. If it is not fit, it may cause short, fire, malfunction.
- ▶ Let no foreign material enter such as garbage or disconnection part into module. It may cause fire, malfunction, error.

4.3.1 Power wiring

(1) In case voltage regulation is larger than specified, connect constant voltage transformer.

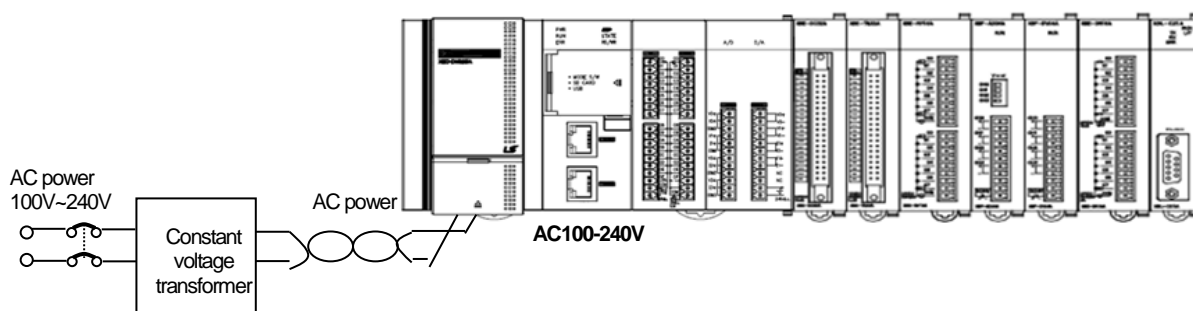

(2) Connect noise that include small noise between line and earth.
(When there are much noise, connect insulated transformer.)

Chapter 4 Installation and Wiring

(3) Isolate the PLC power, I/O devices and power devices as follows.

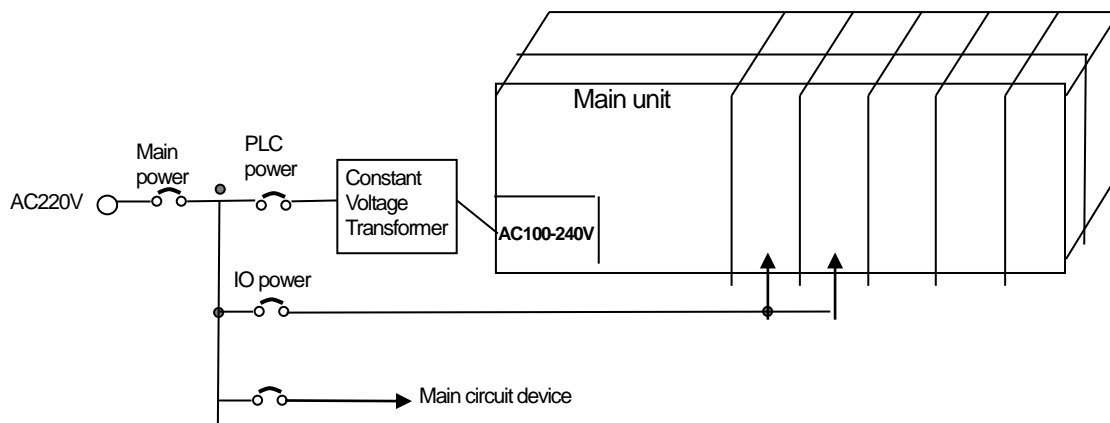

(4) If using DC24V of the main unit

- (a) Do not connect DC24V of several power modules in parallel. It may cause the destruction of a module.
- (b) If a power module can not meet the DC24V output capacity, supply DC24V externally as presented below.

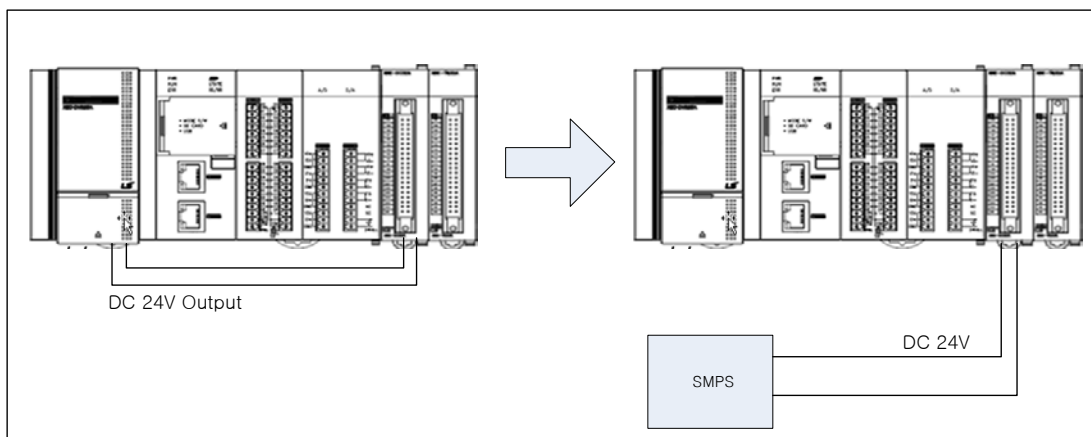

(5) AC110V/AC220V/DC24V cables should be compactly twisted and connected in the shortest distance.

(6) AC110V/AC220V cable should be as thick as possible(2mm²) to reduce voltage drop.

(7) AC110V/ DC24V cables should not be installed close to main circuit cable(high voltage/high current) and I/O signal cable. They should be 100mm away from such cables

(8) To prevent surge from lightning, use the lightning surge absorber as presented below.

(9) Wiring of each input power should be twisted as short as possible and the wiring of shielding transformer or noise filter should not be arranged via a duct.

(10) To prevent surge from lightning, use the lightning surge absorber as presented below.

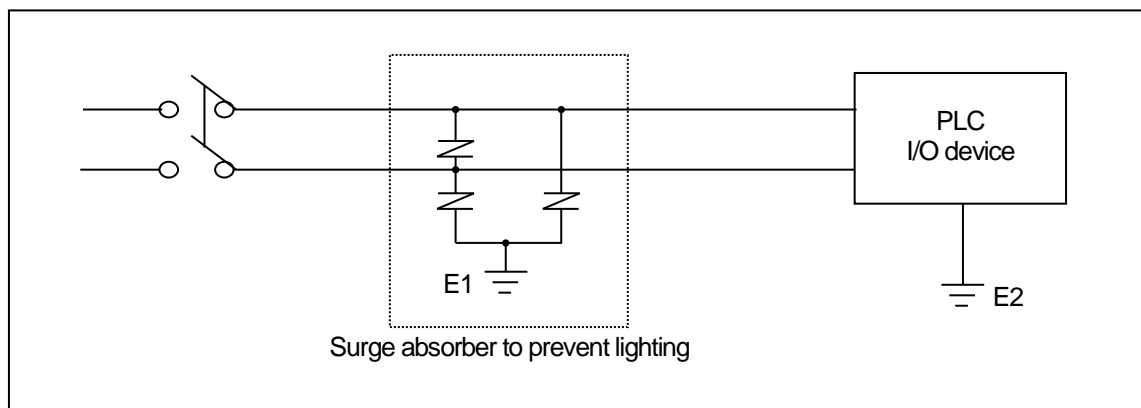
**Remark**

- (1) Isolate the grounding(E1) of lightning surge absorber from the grounding(E2) of the PLC.
- (2) Select a lightning surge absorber type so that the max. voltage may not be the specified allowable voltage of the absorber.

Chapter 4 Installation and Wiring

4.3.2 I/O Device wiring

- (1) The size of I/O device cable is limited to 0.3~2 mm² but it is recommended to select a size(0.3 mm²) to use conveniently.
- (2) Please isolate input signal line from output signal line.
- (3) I/O signal lines should be wired 100mm and more away from high voltage/high current main circuit cable.
- (4) Batch shield cable should be used and the PLC side should be grounded unless the main circuit cable and power cable can not be isolated.

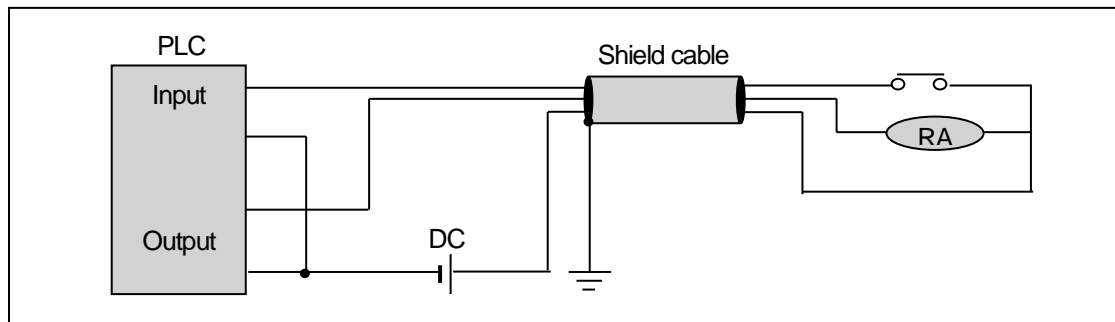

- (5) When applying pipe-wiring, make sure to firmly ground the piping.

(6) Example of input module.

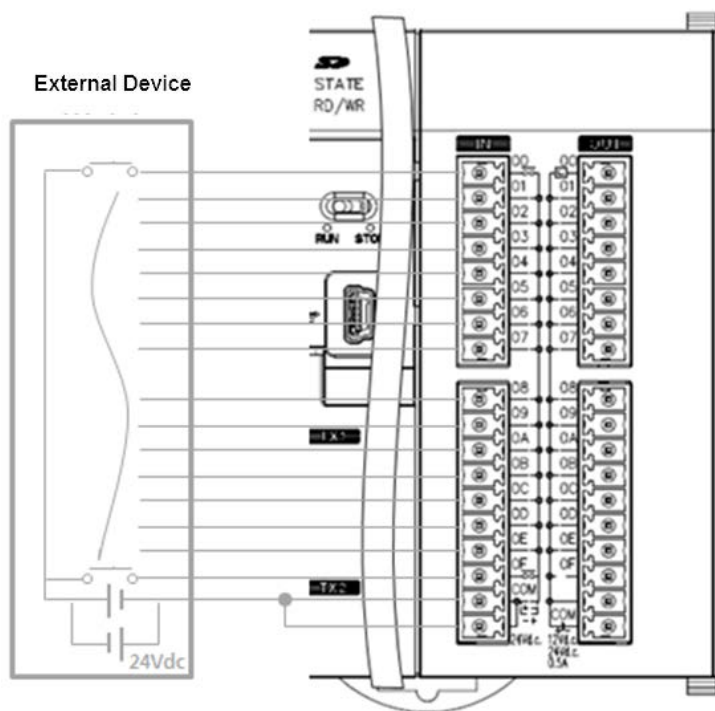

(7) Example of output module.

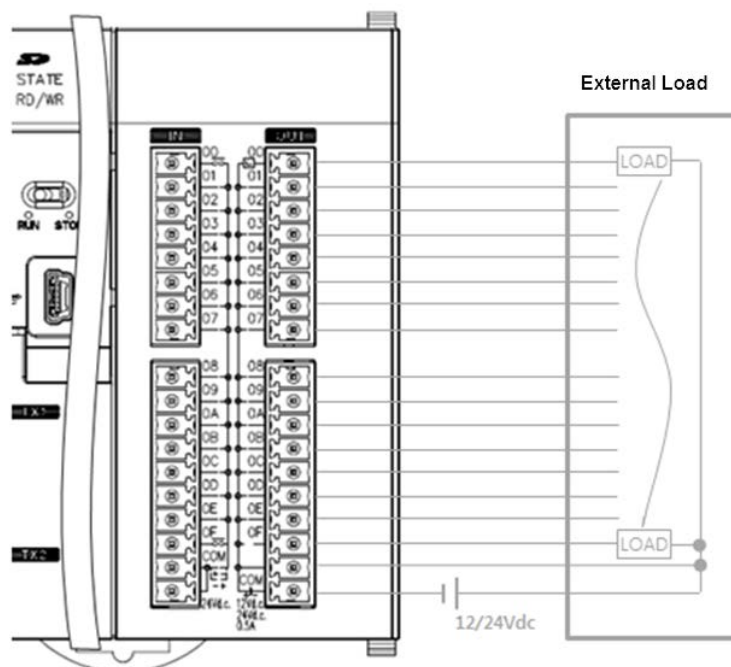

Chapter 4 Installation and Wiring

4.3.3 Grounding wiring

- (1) The PLC contains a proper noise measure, so it can be used without any separate grounding if there is a large noise. However, if grounding is required, please refer to the followings.
- (2) For grounding, please make sure to use the exclusive grounding.
For grounding construction, apply type 3 grounding (grounding resistance lower than $100\ \Omega$)
- (3) If the exclusive grounding is not possible, use the common grounding as presented in B) of the figure below.

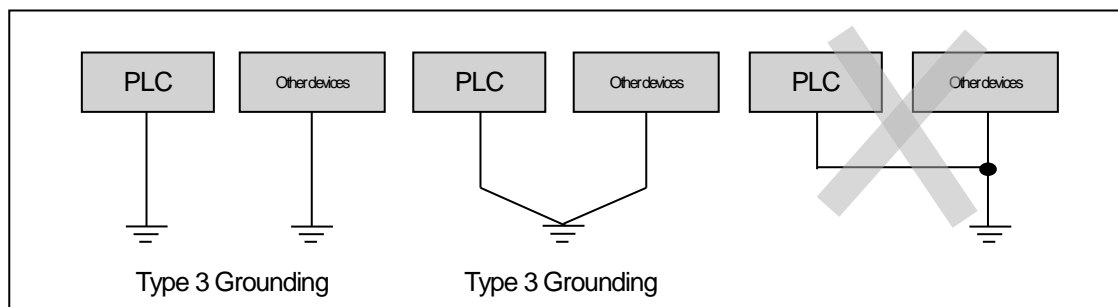

A) Exclusive grounding : best B) common grounding : good C) common grounding: defective

- (4) Use the grounding cable more than $2\ \text{mm}^2$. To shorten the length of the grounding cable, place the grounding point as close to the PLC as possible.
- (5) If any malfunction from grounding is detected, separate the FG of the base from the grounding.

4.3.4 Specifications of wiring cable

The specifications of cable used for wiring are as follows.

Types of external connection	Cable specification (mm^2)	
	Lower limit	Upper limit
Digital input	0.18 (AWG24)	1.5 (AWG16)
Digital output	0.18 (AWG24)	2.0 (AWG14)
Analogue I/O	0.18 (AWG24)	1.5 (AWG16)
Communication	0.18 (AWG24)	1.5 (AWG16)
Main power	1.5 (AWG16)	2.5 (AWG12)
Protective grounding	1.5 (AWG16)	2.5 (AWG12)

Chapter 5 Maintenance

Be sure to perform daily and periodic maintenance and inspection in order to maintain the PLC in the best conditions.

5.1 Maintenance and Inspection

The I/O module mainly consist of semiconductor devices and its service life is semi-permanent. However, periodic inspection is requested for ambient environment may cause damage to the devices. When inspecting one or two times per six months, check the following items.

Check Items		Judgment	Corrective Actions
Change rate of input voltage		Within change rate of input voltage	Hold it with the allowable range.
Power supply for input/output		Input/Output specification of each module	Hold it with the allowable range of each module.
Ambient environment	Temperature	0 ~ +55°C	Adjust the operating temperature and humidity with the defined range.
	Humidity	5 ~ 95%RH	
	Vibration	No vibration	Use vibration resisting rubber or the vibration prevention method.
Play of modules		No play allowed	Securely engage the hook.
Connecting conditions of terminal screws		No loose allowed	Retighten terminal screws.
Spare parts		Check the number of Spare parts and their Store conditions	Cover the shortage and improve the conditions.

5.2 Daily Inspection

The following table shows the inspection and items which are to be checked daily.

Check Items		Check Points	Judgment	Corrective Actions
Connection conditions of base		Check the screws.	Screws should not be loose.	Retighten Screws.
Connection conditions of Input/Output module		Check the connecting screws Check module cover.	Screws should not be loose.	Retighten Screws.
Connecting conditions of terminal block or extension cable		Check for loose mounting screws.	Screws should not be loose.	Retighten Screws.
		Check the distance between solderless terminals.	Proper clearance should be provided.	Correct.
		Connecting of expansion cable.	Connector should not be loose.	Correct.
LED indicator	PWR LED	Check that the LED is On.	On (Off indicates an error)	
	Run LED	Check that the LED is On during Run.	On (flickering or On indicates an error)	
	ERR LED	Check that the LED is Off during Run.	Flickering indicates an error	
	Input LED	Check that the LED turns On and Off.	On when input is On, Off when input is off.	
	Output LED	Check that the LED turns On and Off	On when output is On, Off when output is off	

5.3 Periodic Inspection

Check the following items once or twice every six months, and perform corrective actions as needed.

Check Items		Checking Methods	Judgment	Corrective Actions
Ambient environment	Ambient temperature	-. Measure with thermometer and hygrometer	0 ~ 55 °C	Adjust to general standard (Internal environmental standard of control section)
	Ambient Humidity		5 ~ 95%RH	
	Ambient pollution level	-. measure corrosive gas	There should be no corrosive gases	
PLC Conditions	Looseness, Ingress	The module should be move the unit	The module should be mounted securely.	Retighten screws
	dust or foreign material	Visual check	No dust or foreign material	
Connecting conditions	Loose terminal screws	Re-tighten screws	Screws should not be loose	Retighten
	Distance between terminals	Visual check	Proper clearance	Correct
	Loose connectors	Visual check	Connectors should not be loose.	Retighten connector mounting screws
Line voltage check		Measure voltage between input terminals	3.3 Power specifications	Change supply power

Chapter 6 Troubleshooting

The following explains contents, diagnosis and corrective actions for various errors that can occur during system operation.

6.1 Basic Procedure of Troubleshooting

System reliability not only depends on reliable equipment but also on short downtimes in the event of fault. The short discovery and corrective action are needed for speedy operation of system. The following shows the basic instructions for troubleshooting.

(1) Visual checks

Check the following points.

- Machine operating condition (in stop and operation status)
- Power On/Off
- Status of I/O devices
- Condition of wiring (I/O wires, extension and communications cables)
- Display states of various indicators (such as POWER LED, RUN LED, ERR LED and I/O LED)

After checking them, connect peripheral devices and check the operation status of the PLC and the program contents.

(2) Trouble Check

Observe any change in the error conditions during the following.

- Switch to the STOP position, and then turn the power on and off.

(3) Narrow down the possible causes of the trouble where the fault lies, i.e.:

- Inside or outside of the PLC ?
- I/O module or another module?
- PLC program?

6.2 Troubleshooting

This section explains the procedure for determining the cause of troubles as well as the errors and corrective actions.

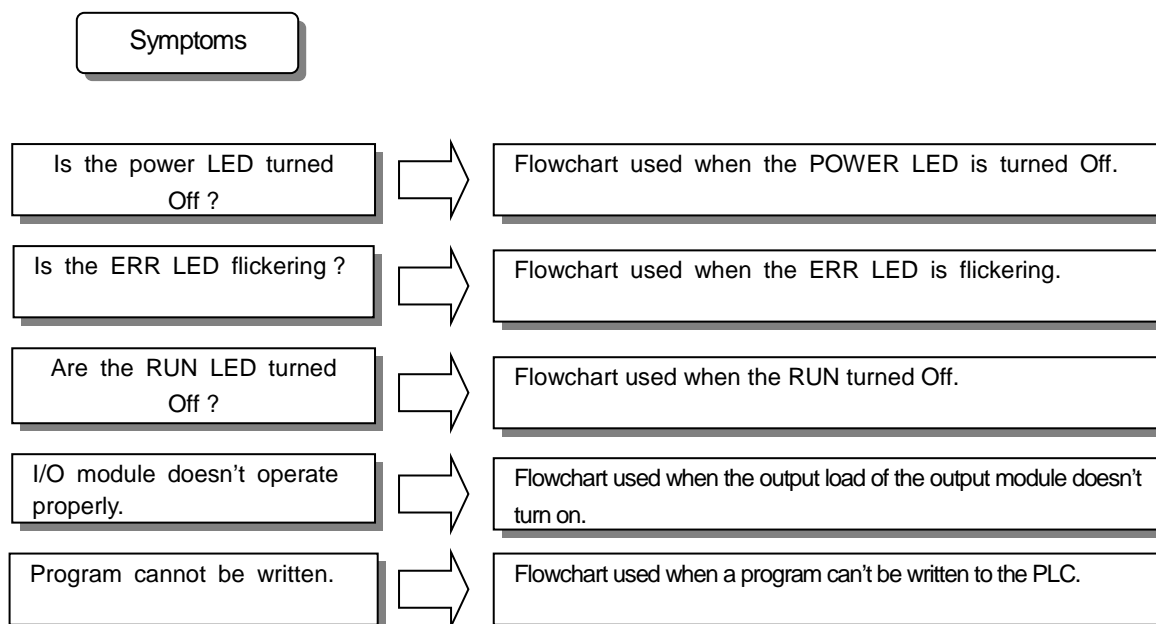

6.2.1 Troubleshooting flowchart used when the PWR (Power) LED turns Off

The following flowchart explains corrective action procedure used when the power is supplied or the power LED turns Off during operation.

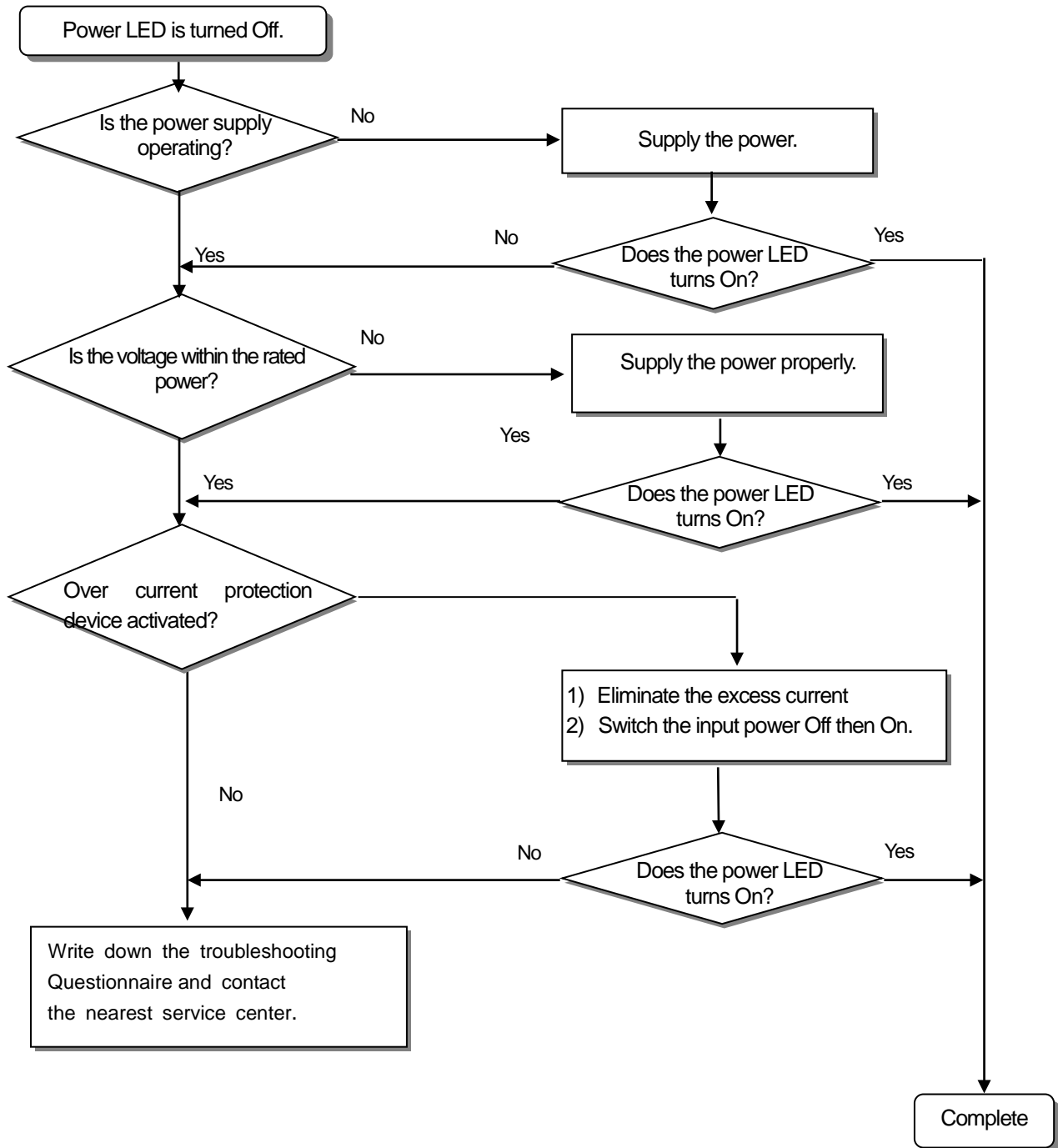

6.2.2 Troubleshooting flowchart used with when the ERR (Error) LED is flickering

The following flowchart explains corrective action procedure used when the power is supplied starts or the ERR LED is flickering during operation.

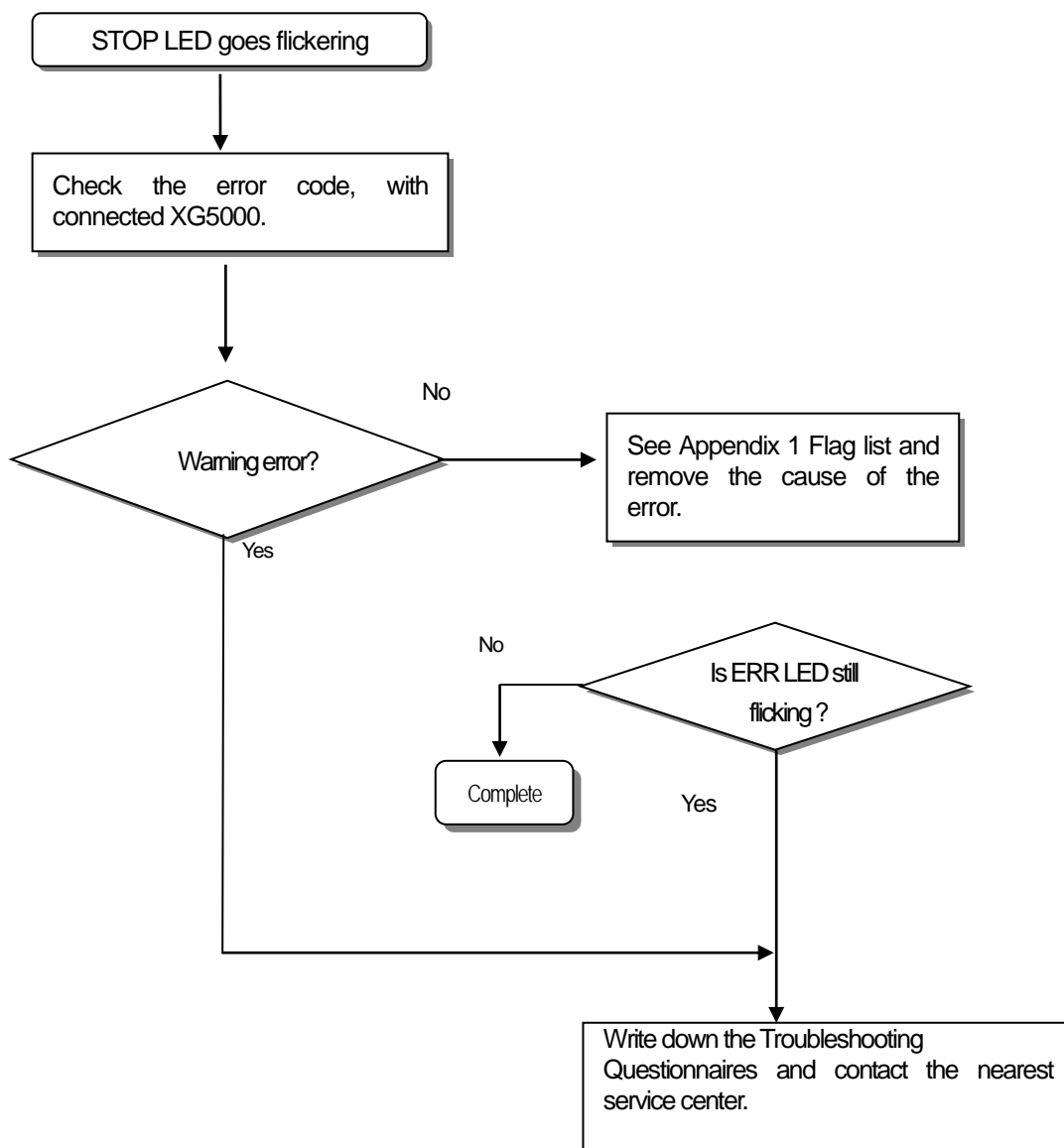

Warning

Though warning error appears, PLC system doesn't stop but corrective action is needed promptly. If not, it may cause the system failure.

6.2.3 Troubleshooting flowchart used with when the RUN , STOP LED turns Off.

The following flowchart explains corrective action procedure to treat the lights-out of RUN LED when the power is supplied, operation starts or is in the process.

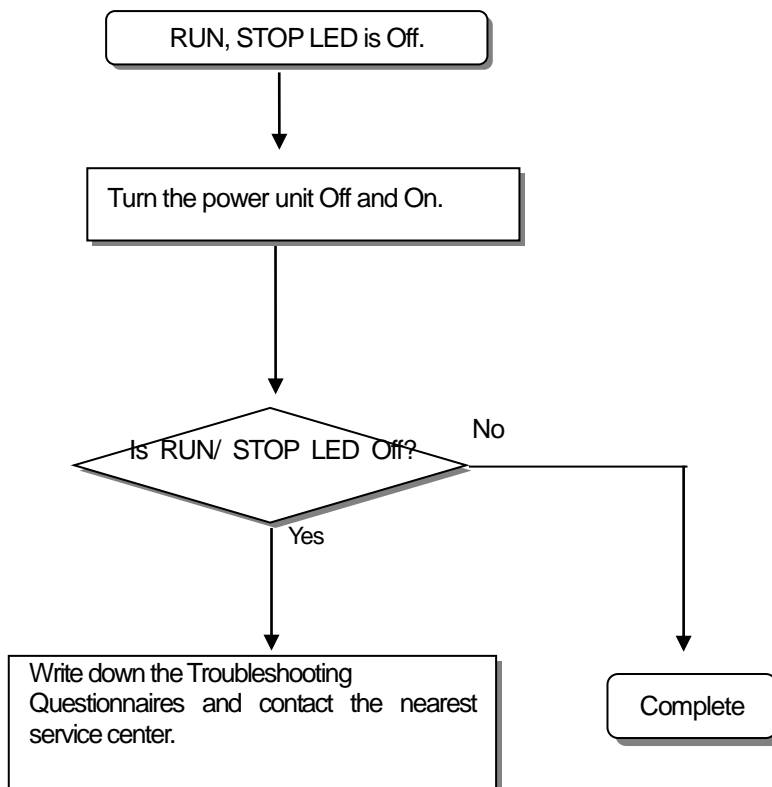

6.2.4 Troubleshooting flowchart used when the I/O part doesn't operate normally.

The following flowchart explains corrective action procedure used when the I/O module doesn't operate normally.

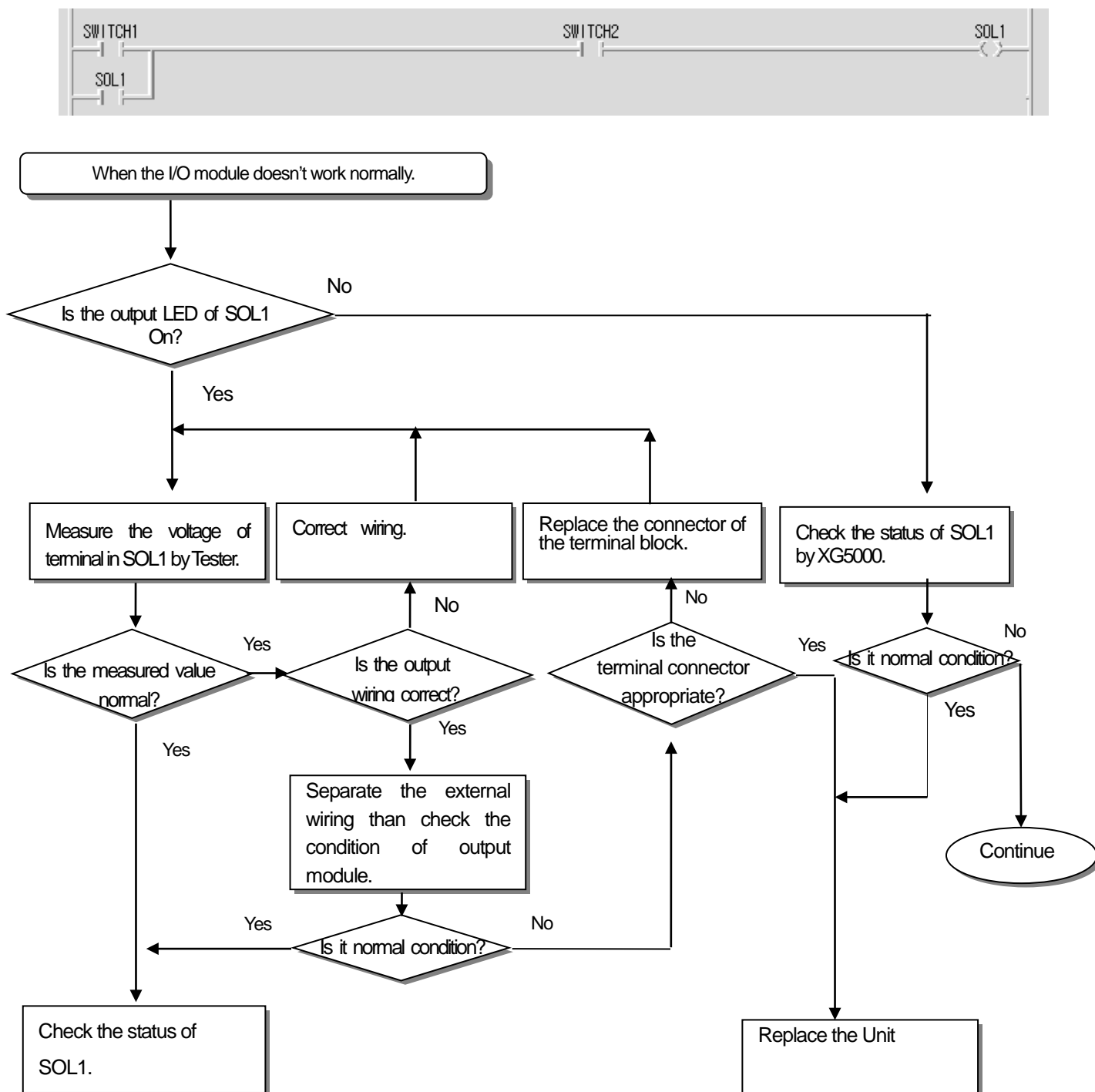

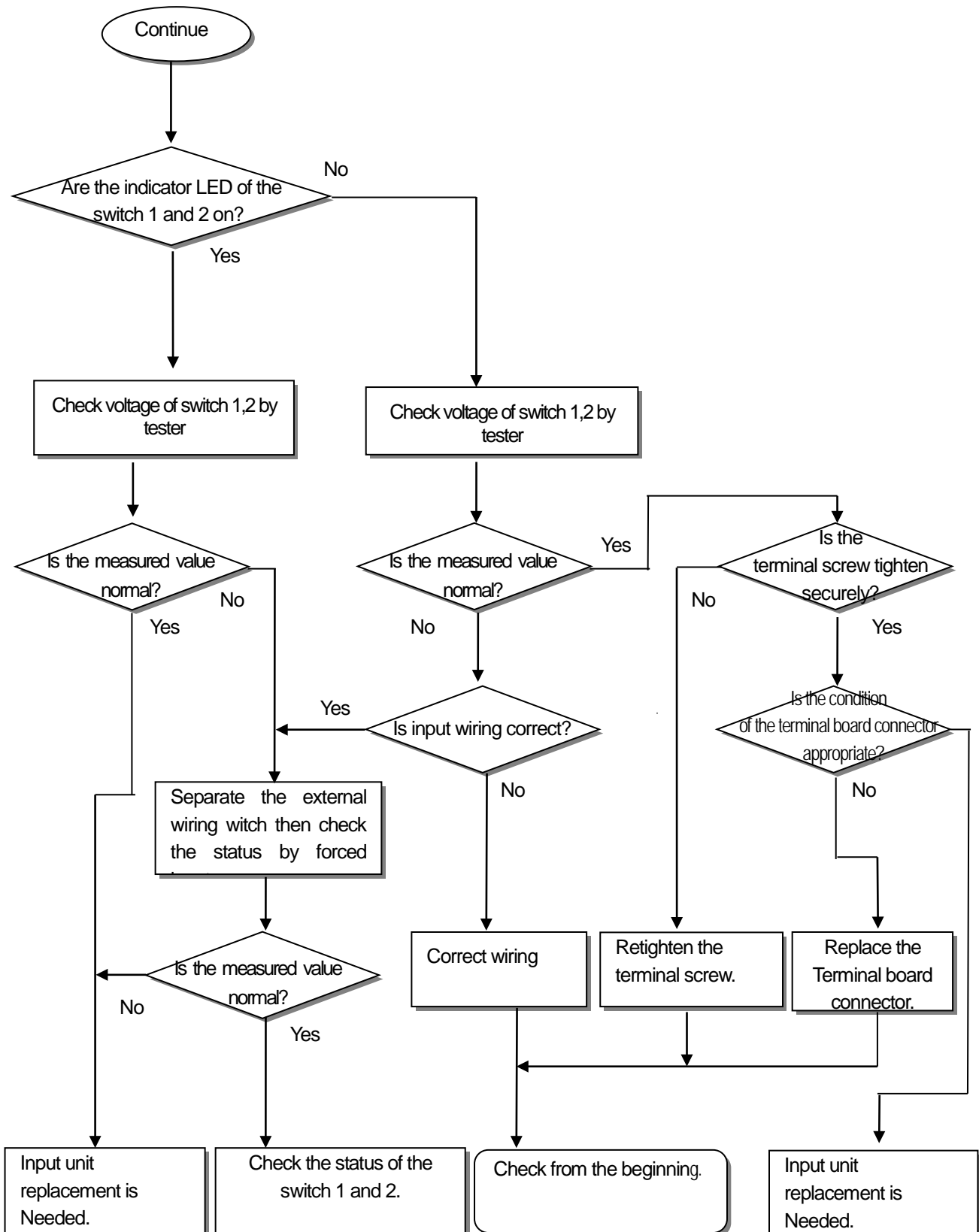

Chapter 6 Trouble Shooting

6.3 Troubleshooting Questionnaire

If any problem occurs during the operation of XGB series, please write down this Questionnaires and contact the service center via telephone or facsimile.

- For errors relating to special or communication modules, use the questionnaire included in the User's manual of the unit.

1. Telephone & FAX No

Tell)

FAX)

2. Using equipment model:

3. Details of using equipment

CPU model: () OS version No.: () Serial No. ()

XG5000 (for program compile) version No.: ()

4. General description of the device or system used as the control object:

5. The kind of the base unit:

– Operation by the mode setting switch (),

– Operation by the XG5000 or communications (),

– External memory module operation (),

6. Is the ERR. LED of the CPU module turned On ? Yes (), No ()

7. XG5000 error message:

8. History of corrective actions for the error message in the article 7:

9. Other tried corrective actions:

10. Characteristics of the error

• Repetitive (): Periodic (), Related to a particular sequence (), Related to environment ()

• Sometimes (): General error interval:

11. Detailed Description of error contents:

12. Configuration diagram for the applied system:

6.4 Troubleshooting Examples

Possible troubles with various circuits and their corrective actions are explained.

6.4.1 Input circuit troubles and corrective actions

The followings describe possible troubles with input circuits, as well as corrective actions.

Condition	Cause	Corrective Actions
Input signal doesn't turn off.	Leakage current of external device (Such as a drive by non-contact switch)	<ul style="list-style-type: none"> Connect an appropriate register and capacity, which will make the voltage lower across the terminals of the input module.
Input signal doesn't turn off. (Neon lamp may be still on)	Leakage current of external device (Drive by a limit switch with neon lamp)	<ul style="list-style-type: none"> CR values are determined by the leakage current value. – Recommended value C : $0.1 \sim 0.47 \mu\text{F}$ R: $47 \sim 120 \Omega$ (1/2W) Or make up another independent display circuit.
Input signal doesn't turn off.	Leakage current due to line capacity of wiring cable.	<ul style="list-style-type: none"> Locate the power supply on the external device side as shown below.
Input signal doesn't turn off.	Leakage current of external device (Drive by switch with LED indicator)	<ul style="list-style-type: none"> Connect an appropriate register, which will make the voltage higher than the OFF voltage across the input module terminal and common terminal.

Chapter 6 Trouble Shooting

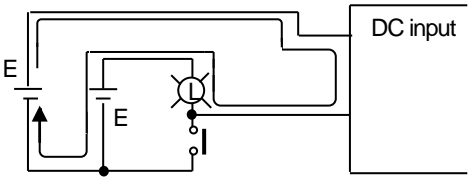
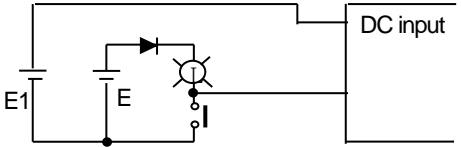
<p>Input signal doesn't turn off.</p>	<ul style="list-style-type: none"> Sneak current due to the use of two different power supplies.  <p>• E1 > E2, sneaked.</p>	<ul style="list-style-type: none"> Use only one power supply. Connect a sneak current prevention diode. 
---------------------------------------	---	--

6.4.2 Output circuit and corrective actions

The following describes possible troubles with output circuits, as well as their corrective actions.

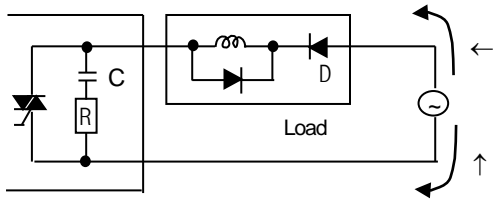
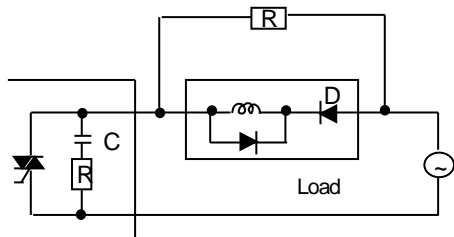
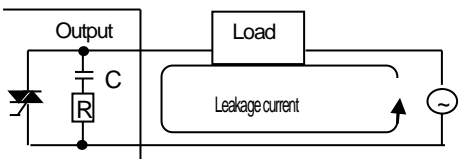
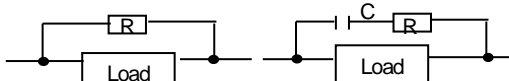
Condition	Cause	Corrective Action
<p>When the output is off, excessive voltage is applied to the load.</p>	<ul style="list-style-type: none"> Load is half-wave rectified inside (in some cases, it is true of a solenoid) When the polarity of the power supply is as shown in ①, C is charged. When the polarity is as shown in ②, the voltage charged in C plus the line voltage are applied across D. Max. voltage is approx. $2\sqrt{2}$.  <p>*) If a resistor is used in this way, it does not pose a problem to the output element. But it may make the performance of the diode (D), which is built in the load, drop to cause problems.</p>	<ul style="list-style-type: none"> Connect registers of tens to hundreds KΩ across the load in parallel. 
<p>The load doesn't turn off.</p>	<ul style="list-style-type: none"> Leakage current by surge absorbing circuit, which is connected to output element in parallel. 	<ul style="list-style-type: none"> Connect C and R across the load, which are of registers of tens KΩ. When the wiring distance from the output module to the load is long, there may be a leakage current due to the line capacity. 

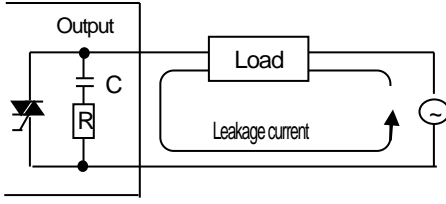
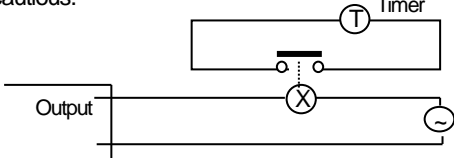
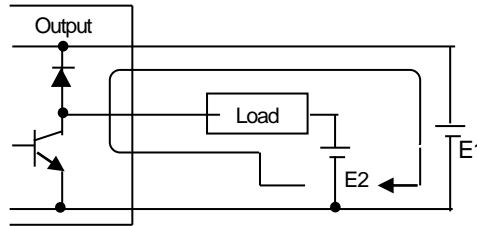
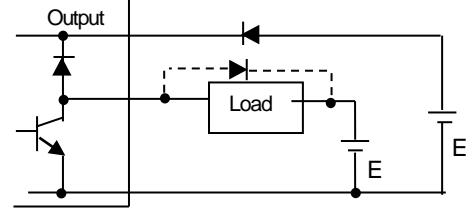
<p>When the load is C-R type timer, time constant fluctuates.</p>	<ul style="list-style-type: none"> Leakage current by surge absorbing circuit, which is connected to output element in parallel. 	<ul style="list-style-type: none"> Drive the relay using a contact and drive the C-R type timer using the since contact. Use other timer than the C-R contact some timers have half-wave rectified internal circuits therefore, be cautious. 
<p>The load does not turn off.</p>	<ul style="list-style-type: none"> Sneak current due to the use of two different power supplies.  <p>$E1 < E2$, sneaks. E1 is off (E2 is on), sneaks.</p>	<ul style="list-style-type: none"> Use only one power supply. Connect a sneak current prevention diode.  <p>If the load is the relay, etc, connect a counter-electromotive voltage absorbing code as shown by the dot line.</p>

Output circuit troubles and corrective actions (continued).

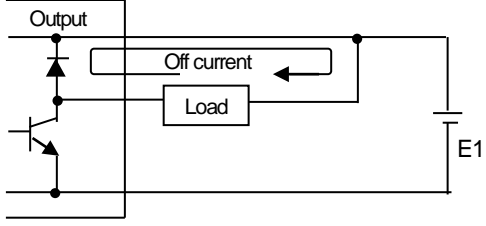
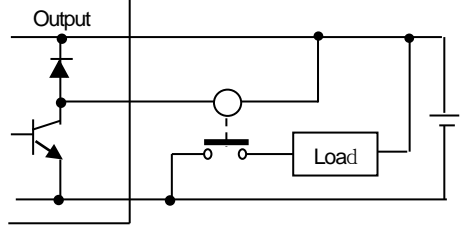
Condition	Cause	Corrective actions
<p>The load off response time is long.</p>	<ul style="list-style-type: none"> Over current at off state [The large solenoid current fluidic load (L/R is large) such as is directly driven with the transistor output.  <ul style="list-style-type: none"> The off response time can be delayed by one or more second as some loads make the current flow across the diode at the off time of the 	<ul style="list-style-type: none"> Insert a small L/R magnetic contact and drive the load using the same contact. 

Chapter 6 Trouble Shooting

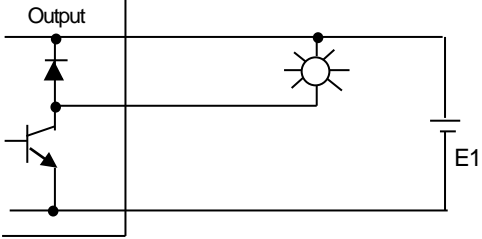
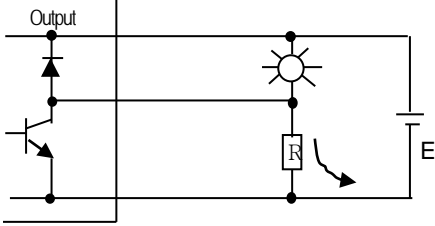
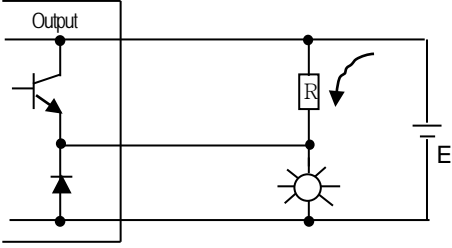
<p>Output transistor is destroyed.</p>	<p>transistor output.</p> <p>Surge current of the white lamp on.</p>  <p>A surge current of 10 times or more when turned on.</p>	<ul style="list-style-type: none"> To suppress the surge current make the dark current of 1/3 to 1/5 rated current flow.  <p>Sink type transistor output</p>  <p>Source type transistor output</p>
--	---	--

6.5 Error Code List

Error code (Dec)	Error cause	Action (restart mode after taking an action)	Operation status	LED status	Diagnosis point
23	Program to execute is abnormal	Start after reloading the program	Warning	0.5 second Flicker	RUN mode
24	I/O parameter error	Start after reloading I/O parameter, Battery change if battery has a problem. Check the preservation status after I/O parameter reloading and if error occurs, change the unit.	Warning	0.5 second Flicker	Reset RUN mode switching
25	Basic parameter error	Start after reloading Basic parameter, Change battery if it has a problem. Check the preservation status after Basic parameter reloading and if error occurs, change the unit.	Warning	0.5 second Flicker	Reset RUN mode switching
26	Compile error exceed	Reduce the program and down.	Heavy error	0.1 second Flicker	RUN mode switching
27	Compile error	Check the program	Heavy error	0.1 second Flicker	RUN mode switching
30	Module set in parameter and the installed module does not match	modify the module or parameter and then restart.	Warning	0.5 second Flicker	RUN mode switching
31	Module falling during operation or additional setup	After checking the position of attachment/detachment of expansion module during Run mode	Warning	0.1 second Flicker	Every scan
33	Data of I/O module does not access normally during operation.	After checking the position of slot where the access error occurs by XG5000, change the module and restart (acc.to parameter.)	Heavy error	0.1 second Flicker	Scan end
34	Normal access of special/link module data during operation not available	After checking the position of slot that access error occurred by XG5000, change the module and restart (acc.to parameter).	Heavy error	0.1 second Flicker	Scan end
38	Extension Module exceed	Extension module is attached over 10 slot or communication module is attached over 3 slot	Heavy error	0.1 second Flicker	RUN mode switching
39	Abnormal stop of CPU or malfunction	Abnormal system end by noise or hard ware error. 1) If it occurs repeatedly when power reinput, request service center 2) Noise measures	Heavy error	0.1 second Flicker	Ordinary time

Chapter 6 Trouble Shooting

Error code (Dec)	Error cause	Action (restart mode after taking an action)	Operation status	LED status	Diagnosis point
40	Scan time of program during operation exceeds the scan watchdog time designated by parameter.	After checking the scan watchdog time designated by parameter, modify the parameter or the program and then restart.	Warning	0.5 second Flicker	While running the program
41	Operation error occurs while running the user program.	Remove operation error → reload the program and restart.	Warning	0.5 second Flicker	While running the program
44	Timer index user error	After reloading a timer index program modification, start	Warning	0.5 second Flicker	Scan end
50	Heavy error of external device	Refer to Heavy error detection flag and modifies the device and restart. (Acc. Parameter)	Heavy error	1 second Flicker	Scan end
55	Task confliction	Check task occurrence	Heavy error	0.5second Flicker	Every time
60	E_STOP function executed	After removing error causes which starts E_STOP function in program, power reinput	Heavy error	1 second Flicker	While running the program

Error code	Error cause	Action (restart mode after taking an action)	Operation status	LED status	Diagnosis point
500	Data memory backup not possible	If not error in battery, power reinput Remote mode is switched to STOP mode.	Warning	1 second Flicker	Reset
501	Abnormal clock data	Setting the time by XG5000 if there is no error	Warning	0.1 second Flicker	Ordinary time
502	Battery voltage falling	Battery change at power On status	Warning	0.1 second Flicker	Ordinary time

Chapter 7 EMC Standard

The following explains contents, diagnosis and corrective actions for various errors that can occur during system operation.

7.1 Requirements for Conformance to EMC Directive

The EMC Directive specifies the products must “be so constructed that they do not cause excessive electromagnetic interference (emissions) and are not unduly affected by electromagnetic interference (immunity)”. The applicable products are requested to meet these requirements.

This section summarizes the precautions on conformance to the EMC Directive of the machinery assembled using PLC XGB series. The details of these precautions are based on the requirements and the applicable standards control. However, LS ELECTRIC will not guarantee that the overall machinery manufactured according to the these details conforms to the below-described directives. The method of conformance to the EMC directive and the judgment on whether or not the machinery conforms to the EMC Directive must be determined finally by the manufacturer of the machinery.

7.1.1 EMC Standard

The standards applicable to the EMC Directive are listed below.

Table13-1

Specification	Test item	Test details	Standard value
EN50081-2	EN55011 Radiated noise * 2	Electromagnetic emissions from the product are measured	30~230 MHz QP : 50 dB μ V/m * 1 230~1000 MHz QP : 57 dB μ V/m
	EN55011 Conducted noise	Electromagnetic emissions from the product to the power line is measured	150~500 kHz QP : 79 dB Mean: 66 dB 500~230 MHz QP : 73 dB Mean: 60 dB
EN61131-2	EN61000-4-2 Electrostatic immunity	Immunity test in which static electricity is applied to the case of the equipment	15 kV Aerial discharge 8 kV Contact discharge
	EN61000-4-4 Fast transient burst noise	Immunity test in which burst noise is applied to the power line and signal lines	Power line: 2 kV Digital I/O : 1 kV Analog I/O, signal lines: 1 kV
	EN61000-4-3 Radiated field AM modulation	Immunity test in which field is irradiated to the product	10V/m, 26~1000 MHz 80%AM modulation @ 1 kHz
	EN61000-4-12 Damped oscillatory wave immunity	Immunity test in which a damped oscillatory wave is superimposed on the power line	Power line: 1 kV Digital I/O (24V or higher): 1 kV

* 1) QP: Quasi-peak value, Mean: Average value

* 2) The PLC is an open type device (device installed to another device) and must be installed in a conductive control panel. The tests for the corresponding items were performed while the PLC was installed inside a control panel.

7.1.2 Control Panel

The PLC is an open type device (device installed to another device) and must be installed in a control panel. This is needed to prevent electric shock by touching XGB PLC and reduce the PLC-generated noise. Install the XGB PLC in a metallic panel to reduce PLC-generated EMI (Electro-magnetic interference),
The specifications for the control panel are as follows:

(1) Control panel

The PLC control panel must have the following features:

- (a) Use SPCC (Cold Rolled Mild Steel) for the control panel.
- (b) The steel plate should be thicker than 1.6mm.
- (c) Use isolating transformers to protect the power supply from external surge voltage.
- (d) The control panel must have a structure which the radio waves does not leak out.

For example, make the door as a box-structure so that the panel body and the door are overlapped each other. This structure reduces the surge voltage generate by PLC.

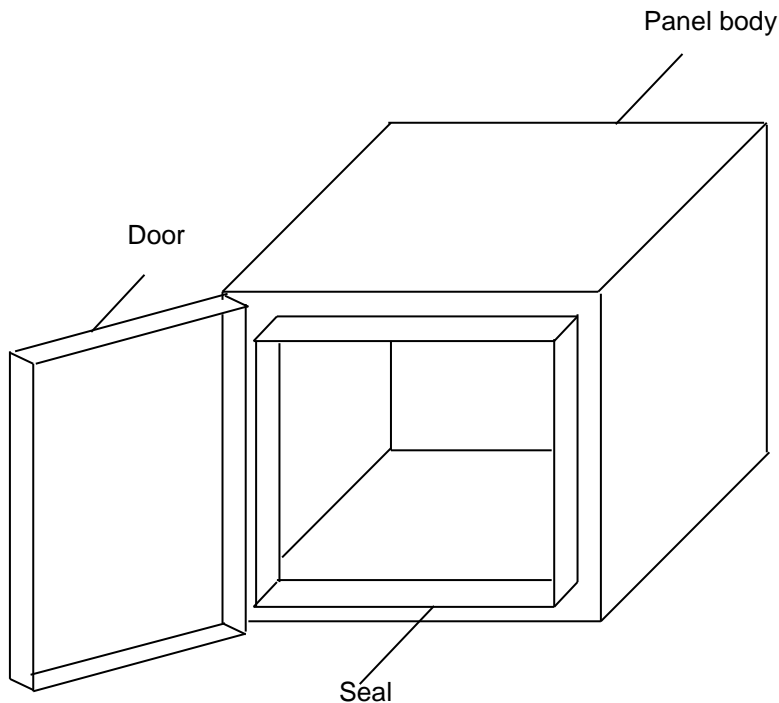

- (e) To ensure good electrical contact with the control panel or base plate, mask painting and weld so that good surface contact can be made between the panel and plate.

(2) Connection of power and earth wires

Earthing and power supply wires for the PLC system must be connected as described below.

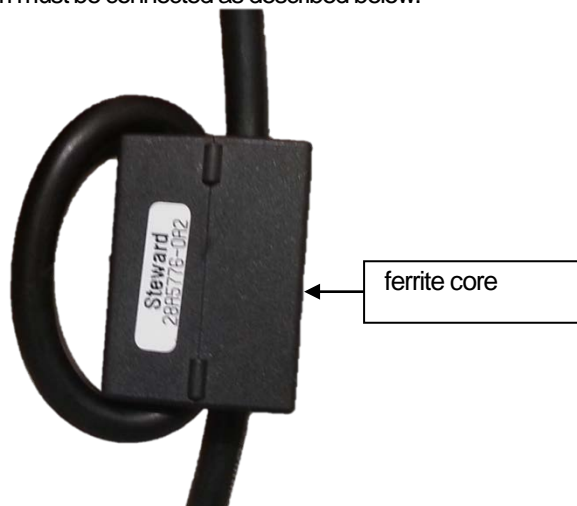

- (a) Earth the control panel with a thick wire so that a low impedance connection to ground can be ensured even at high frequencies.
- (b) The function of LG (Line Ground) and FG (Frame Ground) terminals is to pass the noise generated in the PLC system to the ground, so an impedance that is as low as possible must be ensured.
- (c) The earthing wire itself can generate the noise, so wire as short and thick to prevent from acting as an antenna.
- (d) Attach ferrite core under the power cable to satisfy CE specification.

[ferrite core]

manufacture	name	External Dimension (mm)				maximum cable diameter (mm)	address
		A	B	C	D		
Laird	28A3851-0A2	30.00	13.00	33.70	30.00	12.85	www.lairdtech.com
Laird	28A5776-0A2	29.20	20.00	42.00	42.00	19.40	www.lairdtech.com
Coilmaster	C2L RU130B	31.50	13.00	33.00	31.50	13.00	www.coilmaster.com.tw
TDK	ZCAT3035-1330	30.00	13.00	34.00	30.00	13.00	www.tdk.com

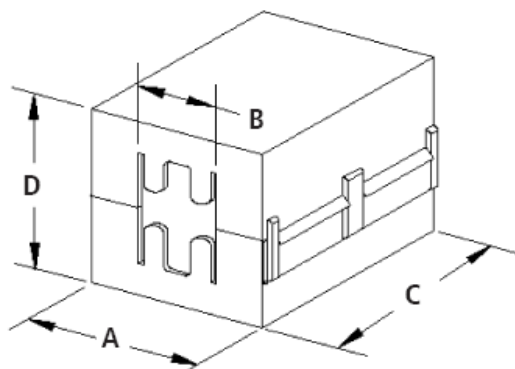

7.2 Requirement to Conform to the Low-voltage Directive

The low-voltage directive requires each device that operates with the power supply ranging from 50V to 1000VAC and 75V to 1500VDC to satisfy the safety requirements. Cautions and installation and wiring of the PLC XGB series to conform to the low-voltage directive are described in this section.

The described contents in this manual are based on the requirements and the applicable standards control. However, LS ELECTRIC will not guarantee that the overall machinery manufactured according to these details conforms to the above regulation. The method of conformance to the EMC directive and the judgment on whether or not the machinery conforms to the EMC Directive must be determined finally by the manufacturer of the machinery.

7.2.1 Standard Applied for XGB Series

The XGB series follow EN6100-1 (safety of devices used in measurement rooms, control rooms, or laboratories). And the XGB series modules which operate at the rated voltage of AC50V/DC75V or above are also developed to conform to the above standard.

7.2.2 XGB Series PLC Selection

(1) Power and CPU

There are dangerous voltages (voltages higher than 42.4V peak) inside the power supply modules of the AC110/220V rated I/O voltages. Therefore, the CE mark-compliant models are enhanced in insulation internally between the primary and secondary.

(2) I/O module

There are dangerous voltages (voltages higher than 42.4V peak) inside the I/O modules of the AC110/220V rated I/O voltages. Therefore, the CE mark-compliant models are enhanced in insulation internally between the primary and secondary.

The I/O modules of DC24V or less rating are out of the low-voltage directive application range.

(3) Special module, Communication module

The special module and communication modules are DC24V or less in rated voltage, therefore they are out of the low-voltage directive application range.

Part 2 Basic Functions

This Chapter covers the details of programming and operations, monitoring of the high performance XGB basic unit (XBC-DN32UX)

Chapter 1 Program Configuration and Operation Method

1.1 Programming Basics

1.1.1 Programming Method

The XBC high performance basic unit supports programming method of repetitive operation interrupt operation, fixed operation.

(1) Repetitive operation mode (Scan)

It means the basic programming method of the PLC.

It is the method that performs the written program repetitively from the first step to the last one and a series of such procedures is called 'program scan'. A series of such processing is called the repetitive operation mode and it can be divided as below.

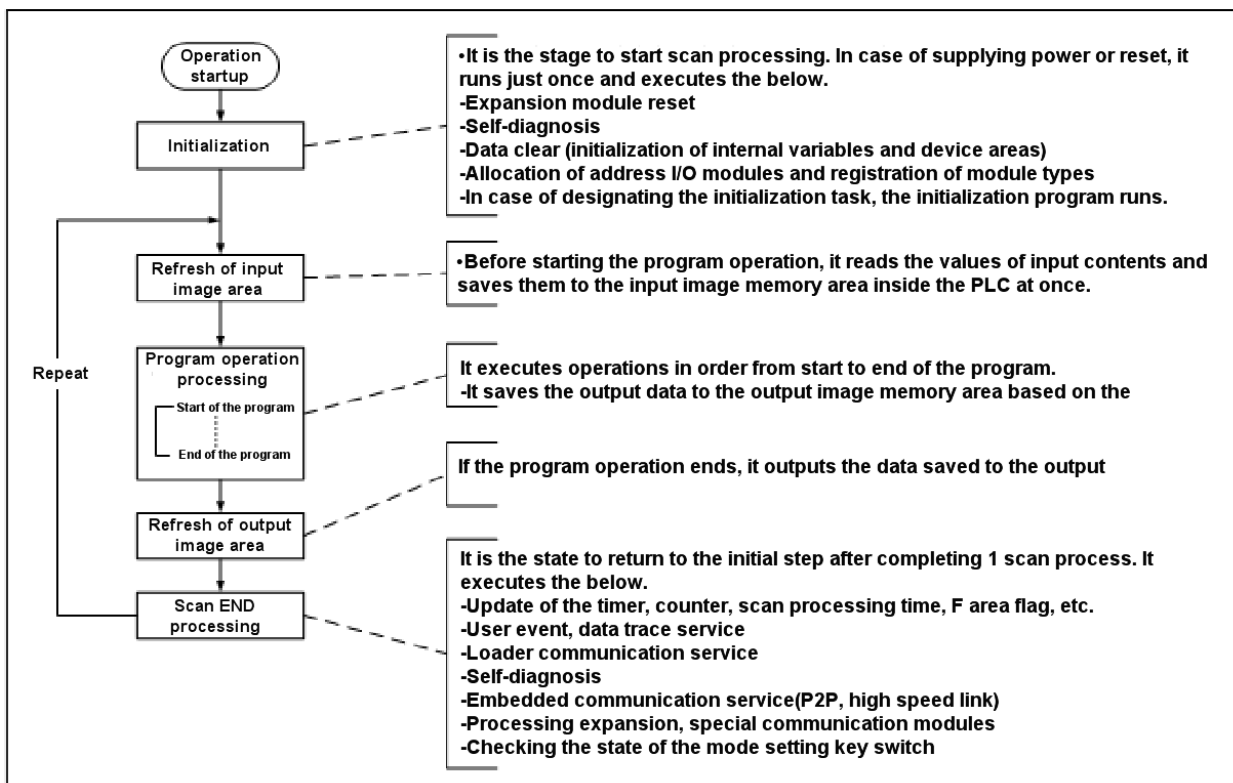

Chapter 1 Configuration and Operation Mode of Programs

(2) Interrupt operation mode (fixed cycle, external interrupt, internal device start, high speed counter)

It is the mode that suspends the currently executed scan program operation and handles the interrupt program immediately when urgent priority matter occurs during execution of the PLC scan program. The signals that inform the CPU of such interrupt occurrence is called 'interrupt signal' and there are 4 kinds as below. For more details on each interrupt operation, refer to Section 1.1.5 ~ 1.1.10.

- Fixed cycle signal: Interrupt signal occurring at the fixed interval
- External input signal: External contact (P0008~0000F) input signal
- Internal device: In case the internal device value is matched with the set occurrence condition
- High speed counter: In case the high speed counter current value is matched with the set value

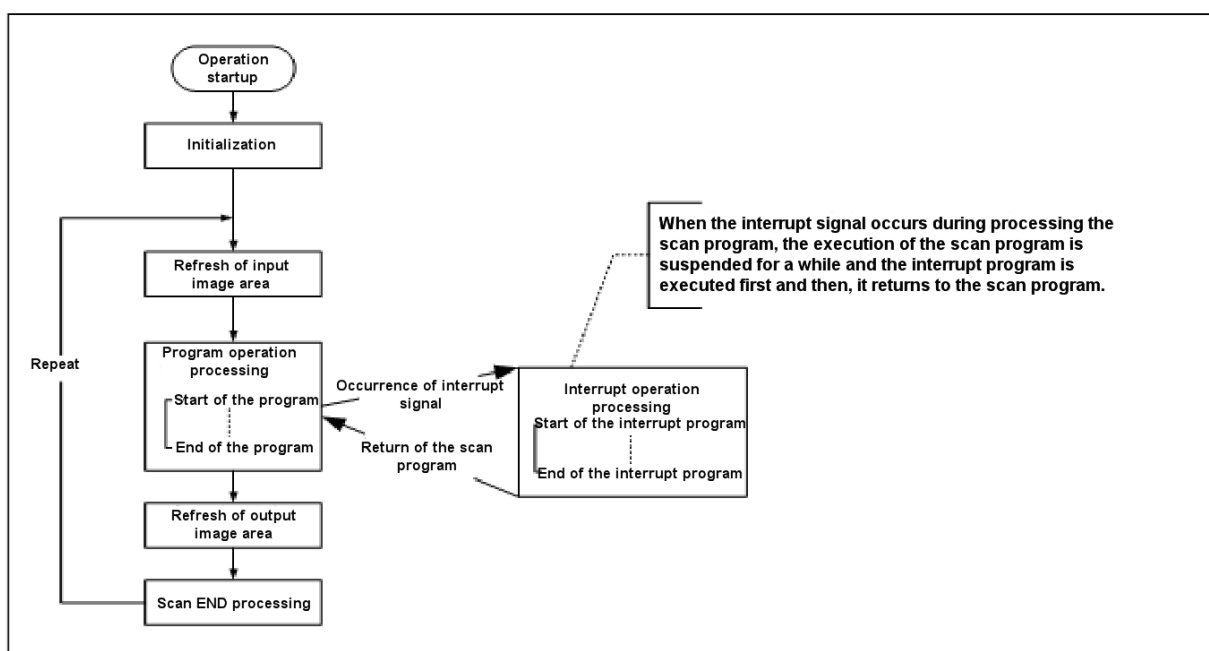

(3) Fixed Cycle Operation mode

It is the mode that executes the scan program every fixed time.

After executing all scan programs, it stands by until the fixed cycle time and then, the next scan will resume at the specified time.

At this time, the current scan time displayed in F area indicates the net program processing time except waiting time. If the actual scan program processing time is longer than the fixed cycle, fixed cycle error flag will be turned On. The flags related to fixed cycle operation are as below.

Bit	Flag Name	Name	Description
%FX92	_CONSTANT_ER	Fixed cycle error	In case the actual scan time is longer than the fixed cycle set value
%FX128	_CONSTANT_RUN	Fixed cycle operation is running	Turned ON during fixed cycle operation

Chapter 1 Configuration and Operation Mode of Programs

1.1.2 Execution processing in case of instantaneous interruption

If the input power voltage supplied to XGB basic unit is lower than the specification, the PLC will detect instantaneous interruption.

When the PLC detects instantaneous interruption, the following execution processing will run.

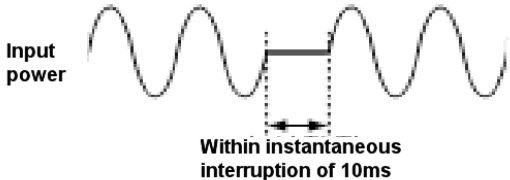
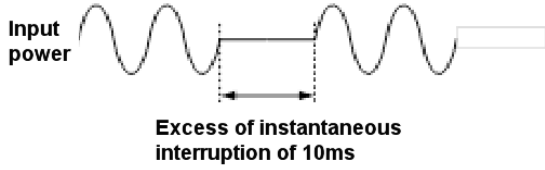
Blackout time	Execution processing
 <p>Input power</p> <p>Within instantaneous interruption of 10ms</p>	<p>(1) Execution is interrupted, maintaining output state of when instantaneous interruption occurred.</p> <p>(2) If instantaneous interruption is canceled, execution will resume.</p> <p>(3) In case execution is suspended due to instantaneous interruption, timer measurement and one for fixed cycle interrupt will be continuously run.</p>
 <p>Input power</p> <p>Excess of instantaneous interruption of 10ms</p>	<p>(1) If instantaneous interruption exceeds 10ms, the PLC will execute restart like the time when power is supplied.</p>

The below figure shows the PLC's execution processing flow chart when instantaneous interruption occurs.

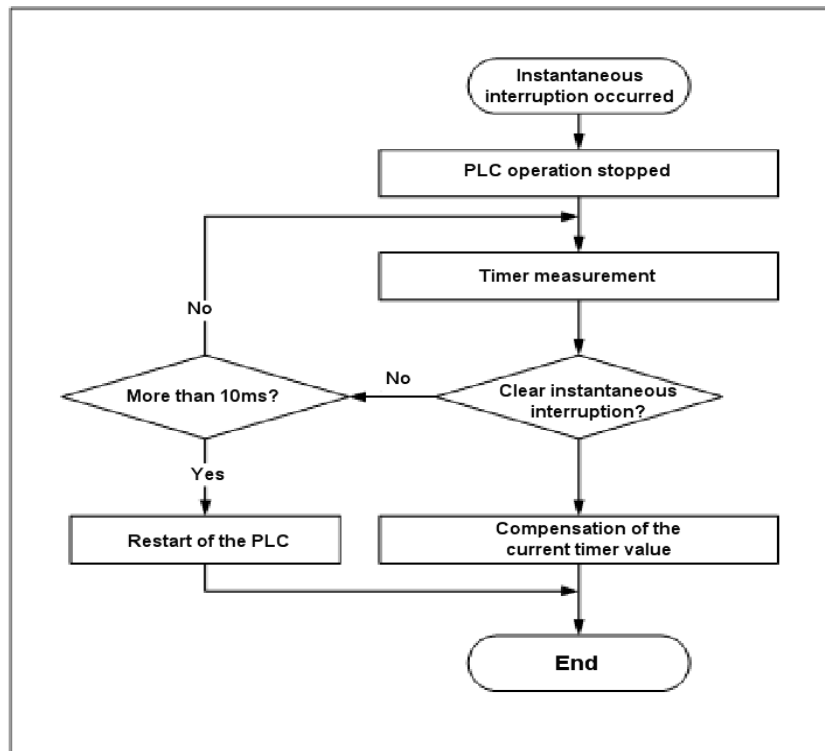

Notice

Instantaneous interruption means the state that the PLC exceeds the allowable variation range of the specified power and is lower than the range. The brief (several ms ~ dozens of ms) blackout is called instantaneous interruption.

Chapter 1 Configuration and Operation Mode of Programs

1.1.3 Scan Time

The scan time is the time that takes to complete a single control operation from step 0 of the full scan program to step 0 of the next scan; it is directly connected to the system's control performance.

(1) Scan time formula

The scan time is the sum of the process time of the scan program and interrupt program written by a user and the PLC's internal END processing time; it can be calculated by the below formula.

(a) Scan time = scan program processing time + interrupt program processing time + PLC internal processing time

- Scan program processing time = Processing time of the user program excluding the interrupt program
- Interrupt program processing time = Sum of the interrupt program running time processed for 1 scan
- PLC internal processing time = Self-diagnosis time + I/O refresh time + internal data processing time + communication service processing time (processing XG5000 service and embedded communication)

Model	MPU processing time		Expansion interface processing time		
	Scan program running (32K)	PLC internal Processing time	Digital I/O module (32 points, 1 EA)	Analog module (8 channels, 1EA)	Communication module (200 byte, 1 block)
XEC-DN32Ux XEC-DP32Ux XEC-DR28Ux	9.7 ms	0.8ms	0.3ms	2.0ms	0.8ms

The high performance XGB basic unit performs the control operation based on the below sequence. Accordingly, you can estimate the rough control performance of the system to be designed by using the below calculation method.

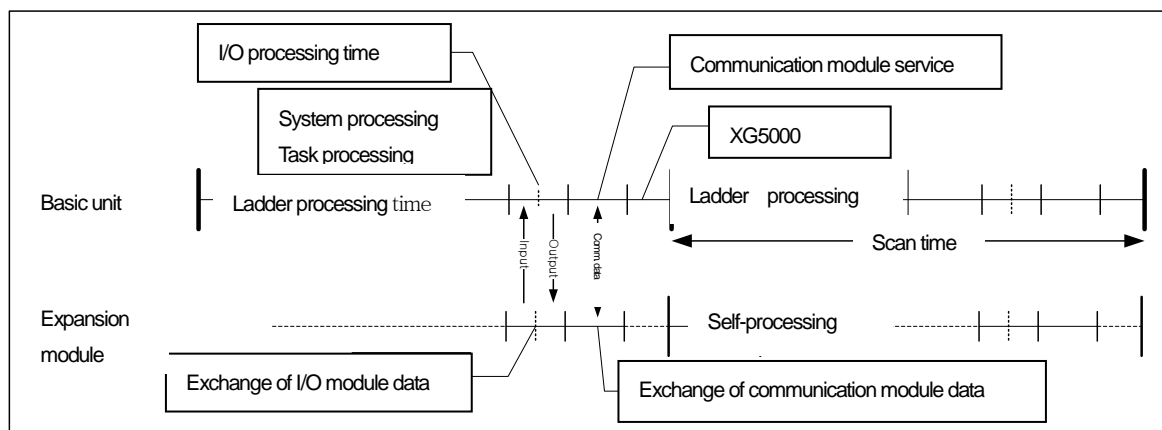

Scan time = Ladder running time + system processing time + digital module I/O processing time + analog I/O processing time + communication module processing time + XG5000 Service processing time

Chapter 1 Configuration and Operation Mode of Programs

(2) Example of calculating the scan time

The example of the high performance XGB PLC's system configuration and the calculation result of the scan time are as follows.

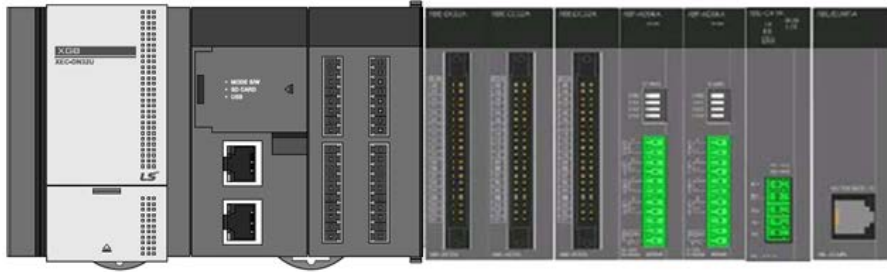

Items	System Configuration							
	Basic unit	SLOT2	SLOT3	SLOT4	SLOT5	SLOT6	SLOT7	SLOT8
Product name	XEC-DN32U	XBE-DC32A * 3EA			XBF-AD04A * 2EA		XBL-C41A	XBL-EMTA
Operating conditions	32kStep	-			-		200 Byte per module, 1 block	

Scan time = Ladder running time + system processing time + digital I/O processing time + analog I/O processing time + communication module processing time + XG5000 Service processing time = 9.7 + 0.8 + 0.3*3 + 2.0*2 + 0.8*2 + 0.1μs = 17.1ms

However, in the event of changing during RUN or writing communication parameters with XG5000, it requires converting the program changed during RUN into executable machine code in the PLC or other internal processing operations for changed communication parameters so the scan time may be temporarily increased by several ms or more.

(3) Verification of the scan time

The PLC's scan time can be verified by using XG5000 or flag as below.

(a) How to use XG5000: Click 『Online』 - 『Diagnosis』 - 『PLC information』 - 『Performance』 .

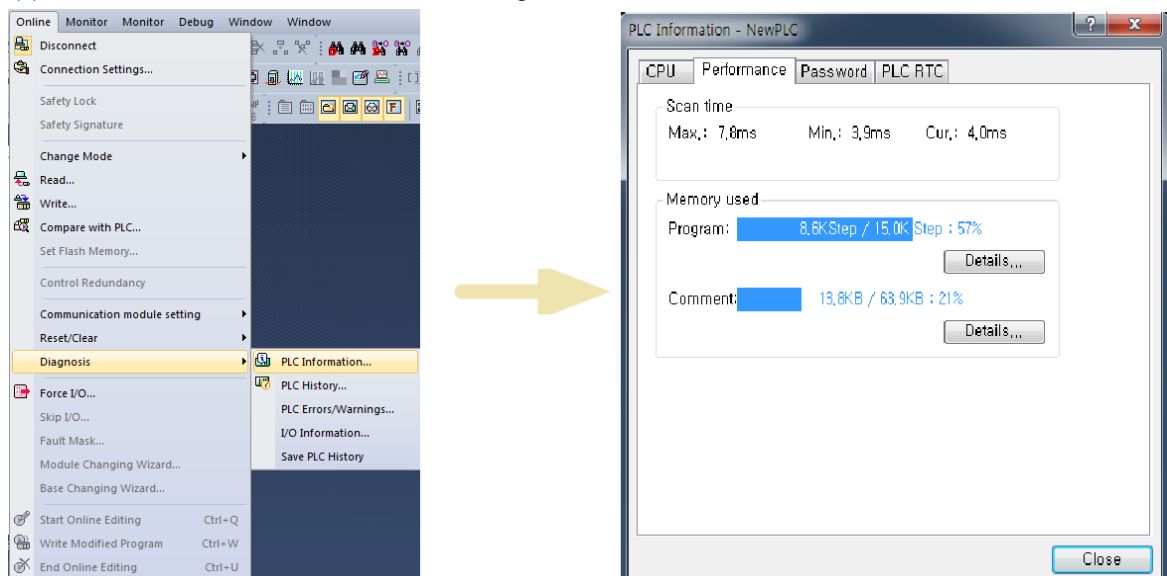

(b) How to use flag : The scan time is saved in the below system flag (F) area.

Chapter 1 Configuration and Operation Mode of Programs

WORD	Flag Name	Name	Description
%FW50	_SCAN_MAX	Maximum scan time	The longest scan time (update in case of occurrence only), in 0.1ms
%FW51	_SCAN_MIX	Minimum scan time	The shortest scan time (update in case of occurrence only), in 0.1ms
%FW52	_SCAN_MAX	Current scan time	Running time of this scan (scan update), in 0.1ms

1.1.4 Program Composition

The program is composed of all function factors required to perform a specific control and they are saved in the basic unit's RAM or flash memory. The function factors to execute the program can be generally divided as below.

Function factors	Executing details
Initialization program	<ul style="list-style-type: none"> • After applying power, it is the program that is firstly executed after completing the self-initialization operations required to operate the PLC. It should run until the INIT_DONE command executes. • When the initialization program runs, only the initialization program is available until the INIT_DONE command runs; the scan program and fixed cycle, external interrupt, internal device task program are not executed. All other embedded functions such as I/O refresh, high speed counter, communication are normally executed. • It is used to program various operations required for the initial settings of the system configured with the high performance XGB PLC.
Scan program	<ul style="list-style-type: none"> • Repeated regularly at every scan. It performs the operation repetitively from the first step to the last step in order of being written. • If the fixed cycle interrupt, external contact interrupt, high speed counter interrupt occur during execution of the scan program, it will stop the scan program and return to the scan program after executing the relevant interrupt program.
Fixed cycle interrupt program	<ul style="list-style-type: none"> • Executed at every set cycle regardless of the scan program. It can be applied to execute the following time conditions. <ul style="list-style-type: none"> ▶ Execution at the shorter time interval than 1 scan processing time ▶ Execution at the longer time interval than 1 scan processing time ▶ Execution at the fixed time interval
External contact interrupt program	<ul style="list-style-type: none"> • Executed every time the input conditions (rising edge, falling edge, transition) of the set external input signal occur. It can be applied when immediate execution is required for external input conditions.
High speed counter interrupt program	<ul style="list-style-type: none"> • Executed when the high speed counter's current value is matched with the set value.
Internal device interrupt program	<ul style="list-style-type: none"> • Executed when the set internal device is matched with relational conditions. • Detects whether starting conditions of the internal device interrupt occurs during END after executing the scan program
Subroutine program	<ul style="list-style-type: none"> • Executed only when the input condition of the CALL command is On.

Notice

- 1) Make the interrupt program as shortly as possible. In case the same interrupt occurs repeatedly during executing the interrupt program, O/S watchdog error may occur with non-execution of the scan program.
(In case the self-interrupt occurs during executing the interrupt program, task conflict error may occur.)
- 2) Although interrupts with low priority occur several times during executing the one with high priority, the interrupt will run just once so you should pay attention to set up the priority.

Chapter 1 Configuration and Operation Mode of Programs

1.1.5 Interrupt

(1) Interrupt processing flow chart

It describes the PLC's operation flow chart, giving you the example of setting the interrupt program as below.

• Interrupt setting

Interrupt type	Interrupt Name	Priority	Task No.	Program Name	Remarks
Initialization	Interrupt0	-	-	Initialization program	
Fixed cycle 1	Interrupt1	2	0	Fixed cycle 1	
External	Interrupt2	2	16	External	
Internal device	Interrupt3	3	24	Internal device	
High speed counter	Interrupt4	4	40	High speed counter	
Fixed cycle 2	Interrupt5	3	1	Fixed cycle 2	

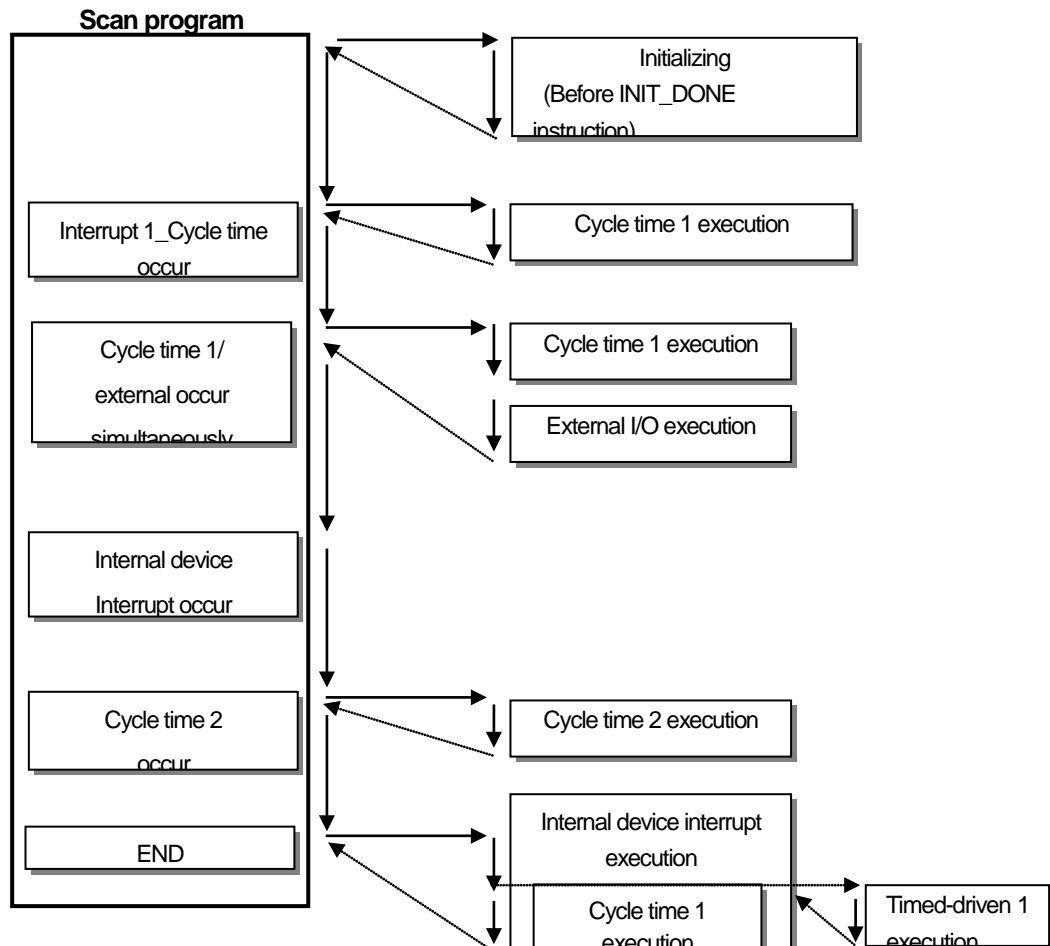

Notice

- 1) If the interrupt with the same priority occur at the same time, the early set interrupt will be executed first. (In case 'interrupt 1' and 'interrupt 2' occur at the same time, 'interrupt 1' will be executed first.)
- 2) If the interrupt with higher priority occurs during execution of interrupts, the interrupt with higher priority will be executed first.
- 3) All interrupts are allowable (Enable) when the power is On. If you want to run by interrupt program or prohibit them, you can use EI, DI command.
- 4) The internal device interrupt will run after getting the END command.

Chapter 1 Configuration and Operation Mode of Programs

(2) Types and operation standards of tasks

The types and operation standards of tasks that are available for the high performance small-sized PLC are as below.

Type Spec.	Fixed cycle task	External contact task	Internal contact task	High speed counter task
Maximum number	16 EA	8 EA	16 EA	8 EA
Start conditions	Fixed cycle (Can be set up to 4,294,967.295 seconds, in 1ms)	Rising or falling edge of the basic unit P008~P00F input contacts	Internal device's designated conditions	High speed counter comparative output 0 / The minimum set value is matched
Detection and Execution	Executed cyclically at every setting time	Executed immediately when the edge of the basic unit P008~P00F input contacts occur	Executed with searching conditions after completing the scan program	Executed when the current counter value is matched with the minimum set value of the comparative output 0
Detection delay Time	Delayed for the maximum of 1ms	Within the maximum of 0.05ms	Delayed as much as the maximum scan time	Within the maximum of 0.25ms
Priority of executions	2 ~ 7 level setting (2 level has the highest priority)	Same as the left	Same as the left	Same as the left
Task No.	Designated without overlapped users in the range of 0~15	Designated without overlapped users in the range of 16~23	Designated without overlapped users in the range of 24~39	Designated without overlapped users in the range of 40~47

(3) Processing method of the task program

It describes the common processing methods and instructions for the task program.

(a) Characteristics of the task program

- In contrast with the scan program, the task program runs only when the execution conditions occur without repetition processing. When writing the task program, consider this point.

For example, if the timer and counter are applied to the task program with the fixed cycle of 10 seconds, the maxim error of 10 seconds may occur in the timer. The counter reflects the input state every 10 seconds so the input that changed within 10 seconds is not counted.

(b) Execution priority

- In case several tasks to be executed stand by, the task program with high priority should be processed first. If the tasks with the same priority stand by, they should be processed in order of occurrence.
- When the fixed cycle task and external contact task occur at the same time, the task set early by XG5000 will be executed by priority.
- Set up the priority of the task programs in consideration of characteristics, importance of the programs and urgency of required executions.

(c) Processing delay time

The delay of task program processing is caused by the below causes. Consider these factors when setting up tasks and writing programs.

- Delayed detection of tasks (Refer to the detailed description of each task.)
- Program execution delay due to execution of the preceding task program
- Input/output data refresh of expansion special module

Chapter 1 Configuration and Operation Mode of Programs

- (d) Relation between the initialization, scan program and the task program
- When executing the initialization task program, the fixed cycle, external contact, high speed counter, internal contact task cannot be started.
 - The scan program has the lowest priority so when the task occurs, the scan program will be suspended and the task program will be executed preemptively. Accordingly, in case the tasks occur frequently during one scan or they converge intermittently, the scan time may be extended abnormally. You should consider this point when setting tasks.
- (e) Protection of the currently running scan program by prohibiting tasks execution
- If you do not want the scan program to be suspended by the task program with high priority during executing the scan program, you can partially prohibit the execution of task programs by using the below DI, EI command in order to protect the scan program.
(When the power is supplied to the PLC, the initial values of all tasks are EI (allowable) state.)

Command	Use	Description
EI		Allows the start of all tasks.
DI		Prohibits the start of all tasks.

(4) Verification of task program

After writing the task program, verify it based on the following instructions.

(a) Are the occurrence conditions of tasks proper?

If tasks occur frequently beyond necessity or if several tasks occur in one scan, the scan time may be extended or become irregular. / If you cannot change task settings, check the maximum scan time.

(b) Are the priorities of tasks arranged well?

The task program with low priority may be delayed and fail to be executed in time due to the task program with high priority, in some cases, the pending tasks occur redundantly during execution of the preceding tasks so it may lead to tasks conflicts.

Set up the priority in consideration of urgency, running time, etc. of tasks.

(c) Are task programs made as shortly as possible?

Long running time of the task program can cause the long or irregular scan time or may lead to the conflict of task programs. Make the task programs as shortly as possible.

Especially, when attaching expansion special module, or using PUT,GET instructions, program processing might be delayed. (More than 10ms task cycle is recommended).

When making the task program with fixed cycle, the task program should be executed within 10% of the operation cycle of the shortest task among several tasks.

Ex.) When the task program's running time is 1ms, the fixed cycle time should be more than 10ms.

(d) Is the protection of the program needed for the task with high priority during execution of the program?

Chapter 1 Configuration and Operation Mode of Programs

If the other task interrupts during execution of the task program, after the executing task is completed, among pending tasks, the one will run in order of priority. If you do not want interruption of other tasks during execution of the task program, protect the program with DI, EI applied commands.

(5) Example of program configuration and processing

The example of the program execution sequence is given under the registered tasks and programs as below.

• Registered task programs

Interrupt source	Interrupt Name	Priority	Task No.	Program Name	running time
Fixed cycle	10ms_fixed cycle	3	0	Program1	2ms
Internal contact	Internalcontact_M00	5	24	Program2	7ms
External contact	Externalcontact_P08	2	16	Program3	2ms
-	-	-	-	Scan program	17ms

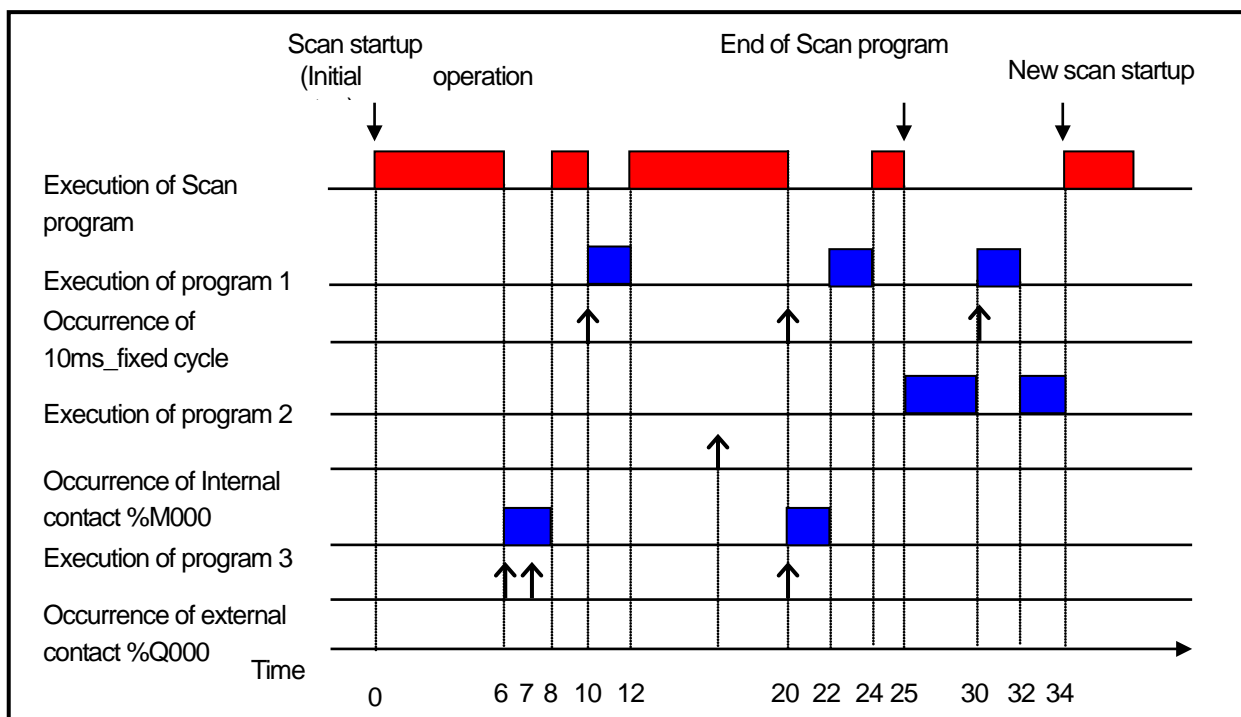

Time (ms)	Executed details
0~6	The scan program starts and is executed.
6~8	Request on running the external contact interrupt is entered and the scan program is interrupted and the program 3 runs. There is the request on rerun at 7[ms] but it is ignored since the program is running.
8~10	The execution of the program 3 is completed and the scan program will run continuously.
10~12	There is the request on running 10ms_fixed cycle interrupt so the scan program is interrupted and the program 1 runs.
12~20	The execution of the program 1 is completed and the scan program that was interrupted runs continuously.
20	Although there are the requests on 10ms_fixed cycle interrupt and the external contact interrupt at the same time, the external contact interrupt has higher priority so the program 3 runs and the program 1 stands by for execution.
20~22	The scan program is interrupted and the program 3 runs.
22~24	The execution of the program 3 is completed and the pending 10ms_fixed cycle interrupt program 1 runs.
24~25	The execution of the program 1 is completed and the scan program is finished.

Chapter 1 Configuration and Operation Mode of Programs

25	The program 2 is executed by checking the interrupt request on internal contact_M0 of P2 at the time of completion of the scan program.
----	---

time (ms)	Executed details
25~30	The program 2 runs.
30~32	The request on 10ms_fixed cycle interrupt occurs and the 10ms_fixed cycle has higher priority so the program 2 is interrupted and the program 1 runs.
32~34	The execution of the program 1 is completed and the program 2 that was interrupted is finished.
34	The new scan starts (startup of executing the scan program)

1.1.6 Initialization task

(1) How to set up the task

You can add initialization tasks in the project window of XG5000 as below and add the programs to be executed. For more details, refer to the XG5000 manual. (You cannot add tasks on online. After disconnecting the PLC, add tasks.)

(a) Adding task: Select 『Project』 – 『Add Items』 – 『Task』 or after clicking with the right mouse button on the project name of the project tree, select 『Add Items』 - 『Task』 as shown in the below figure.

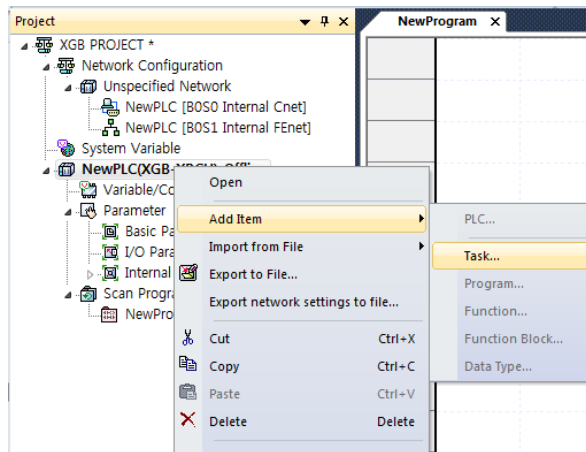

(b) The screen for registering the task will be displayed. Click 『Initialization』 in the execution conditions and enter the task name.

Chapter 1 Configuration and Operation Mode of Programs

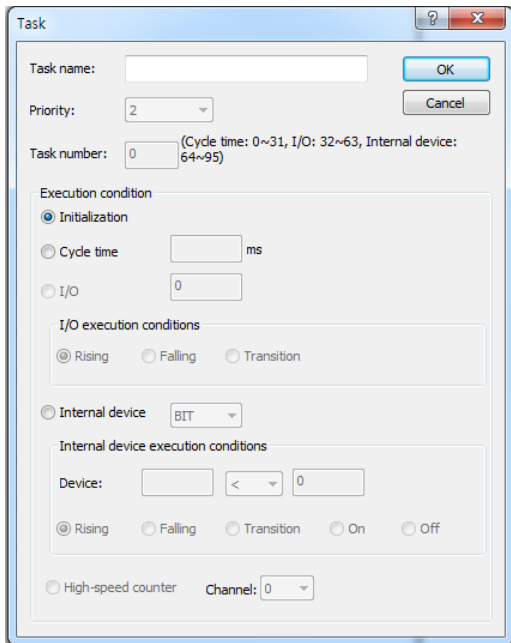

(c) Click on the right mouse button on the registered task and click 『Add Items』 - 『Program』 .

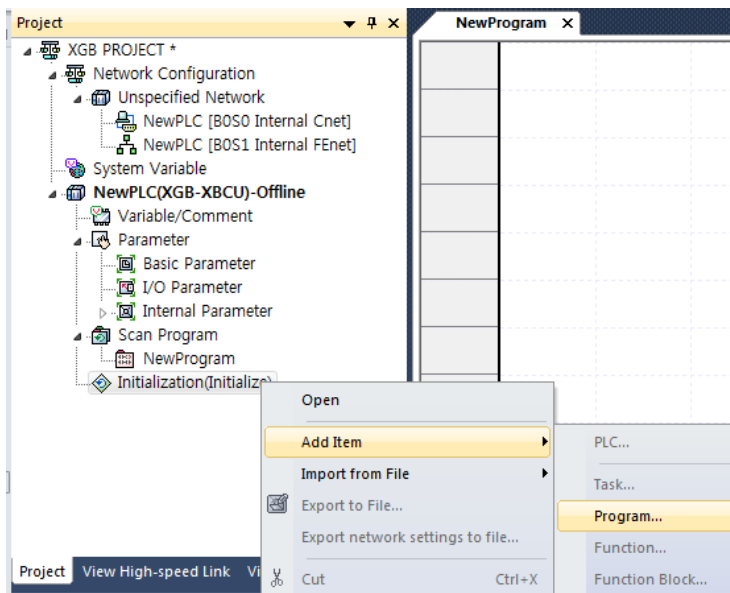

(d) Make the necessary initialization program and make sure to include the INIT_DONE command to the initialization task program.

(If the operation conditions of INIT_DONE runs, the initialization task is ended and the scan program runs.)

Chapter 1 Configuration and Operation Mode of Programs

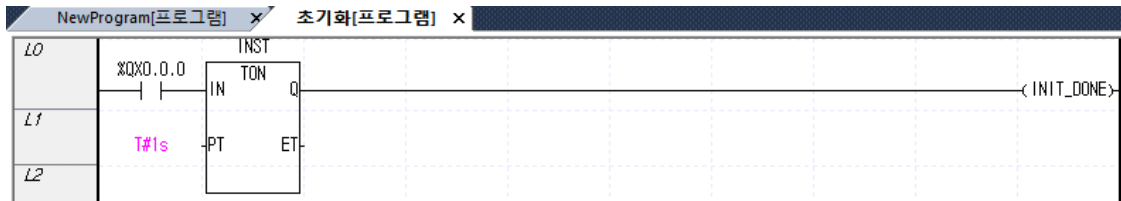

1.1.7 Fixed cycle task

(1) How to set up the task

- (a) Adding tasks: Select 『Project』 – 『Add Items』 – 『Task』 or after clicking with the right mouse button on the project name of the project tree, select 『Add Items』 - 『Task』 as shown in the below figure.

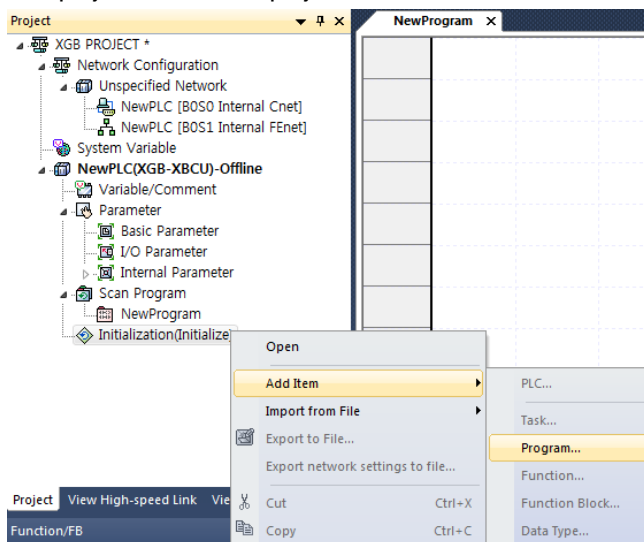

- (b) The screen for registering the task will be displayed. Click 『Fixed cycle』 in the execution conditions and after entering the task name, input the items required for setting as below

Chapter 1 Configuration and Operation Mode of Programs

Items	Input range	Description
priority	2~7	Designates the priority of tasks.
Task No.	0~15	Designates the task number. The numbers overlapped with are not available.
cycle	1~4,294,967,295 (ms)	Designates the task's running cycle.

Task

Task name:

Priority: 2

Task number: 0 (Cycle time: 0~31, I/O: 32~63, Internal device: 64~95)

Execution condition

Initialization

Cycle time ms

I/O 0

I/O execution conditions

Rising Falling Transition

Internal device BIT

Internal device execution conditions

Device: < 0

Rising Falling Transition On Off

High-speed counter Channel: 0

OK Cancel

Chapter 1 Configuration and Operation Mode of Programs

(c) Click on the right mouse button on the registered task and click 『Add Items』 - 『Program』 .

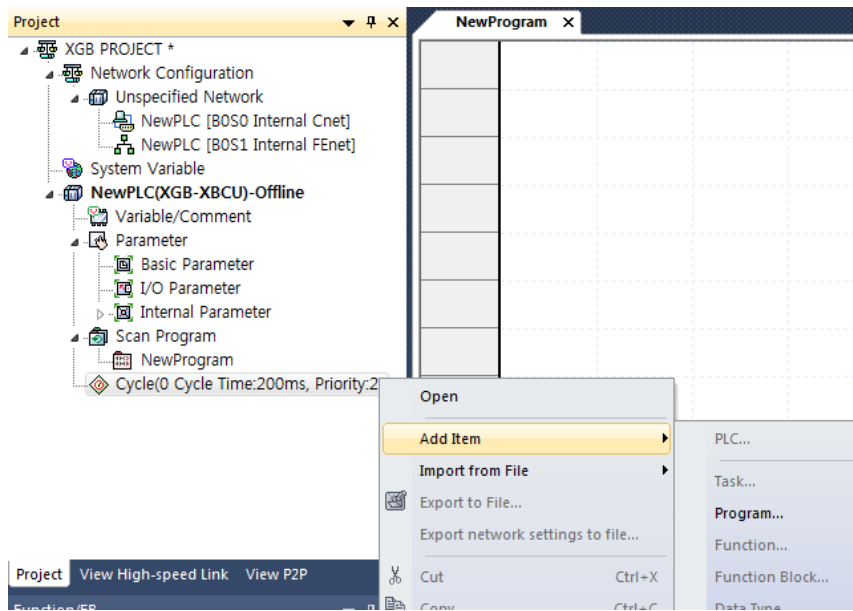

(d) Register the task program name and comment.

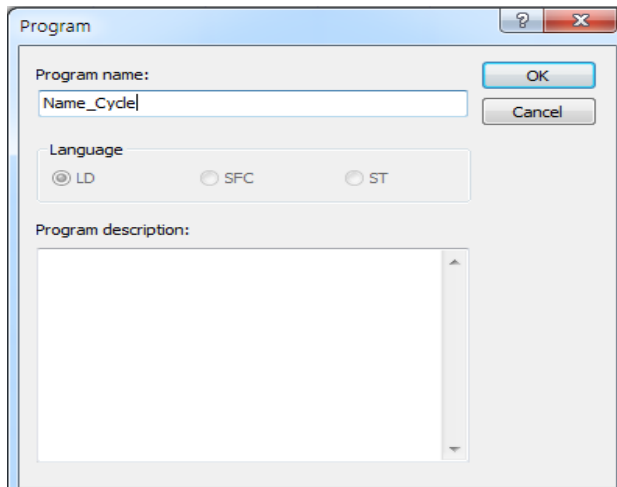

(e) If the program window for writing the task program is displayed, you can make the task program here.

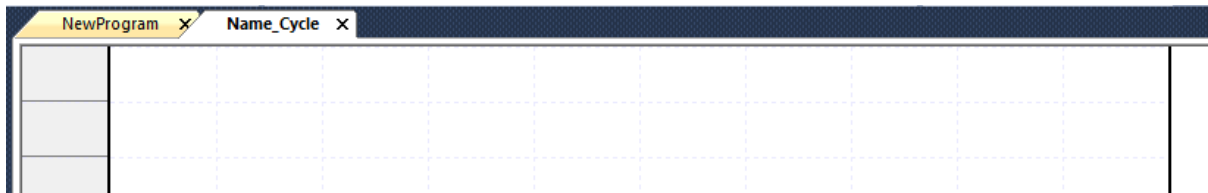

Chapter 1 Configuration and Operation Mode of Programs

(2) Instructions to use the fixed cycle task

The corresponding task program with fixed cycle runs at every set time interval (running cycle) and keep the below instructions in mind.

- When the specific task program with the fixed cycle runs currently or stands by for execution, if the request on running the same task program occurs, the newly occurred task will be ignored.
- The timer generating the request on running the task program with fixed cycle works only when the operation mode is RUN mode. Ignore all the blackout time.
- When setting up the running cycle of the task program with fixed cycle, the request on running several task programs should not occur.

If you apply 4 task programs with the fixed cycle of 2 seconds, 4 seconds, 10 seconds, 20 seconds, 4 execution requests occur simultaneously every 20 seconds and 4 tasks runs at once so the scan time may be longer momentarily.

1.1.8 External contact task

(1) How to set up the task

- (a) Adding tasks: Select 『Project』 – 『Add Items』 – 『Task』 or after clicking with the right mouse button on the project name of the project tree, select 『Add Items』 - 『Task』 as shown in the below figure.

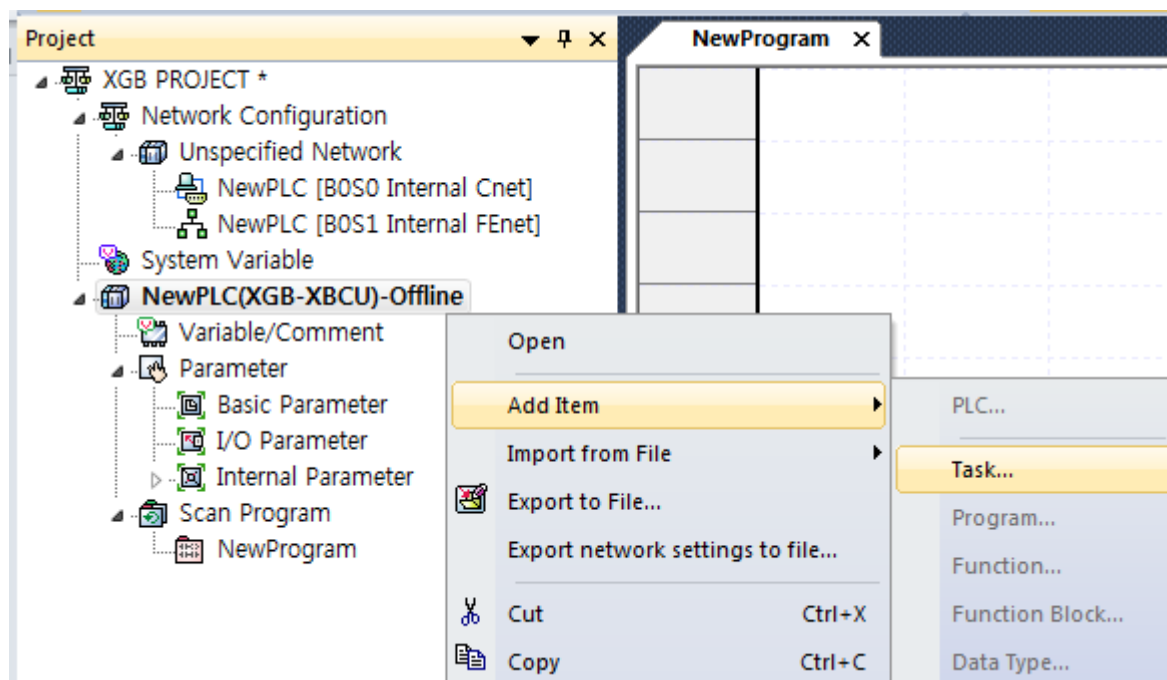

Chapter 1 Configuration and Operation Mode of Programs

- (b) The screen for registering the task will be displayed. Click 『External contact』 in the execution conditions and after entering the task name, input the items required for setting as below.

Items	Input range	Description
Priority	2~7	Designates the priority of tasks.
Task No.	16~23	Designates the task number. The numbers overlapped with are not available.
Contact No.	8~15	Designates the task start contact number.
Starting conditions	rising, falling, transition	Sets up starting conditions of tasks.

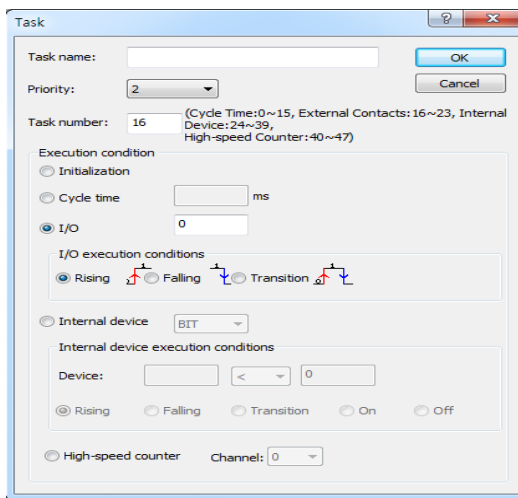

- (c) Click on the right mouse button on the registered task and click 『Add Items』 - 『Program』 .

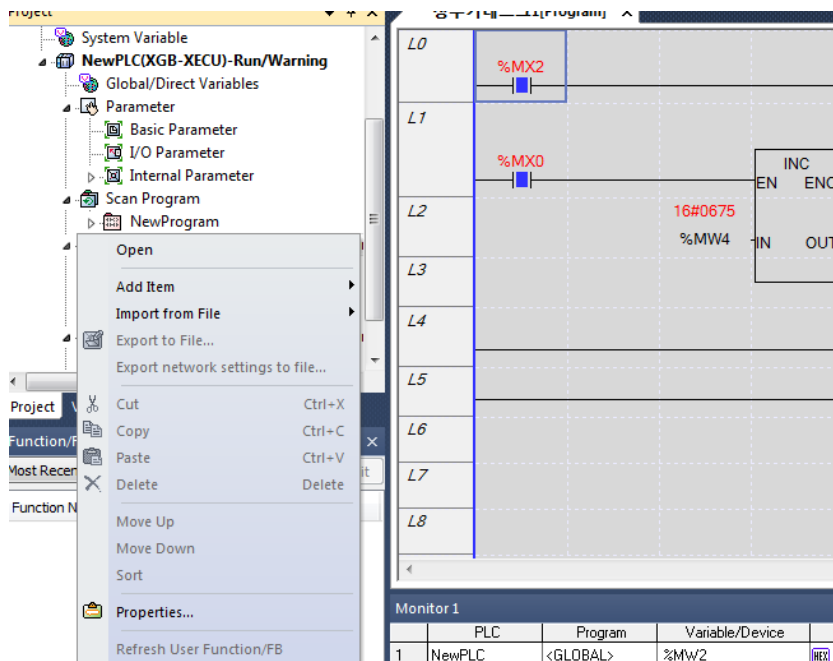

Chapter 1 Configuration and Operation Mode of Programs

(d) Register the task program name and comment.

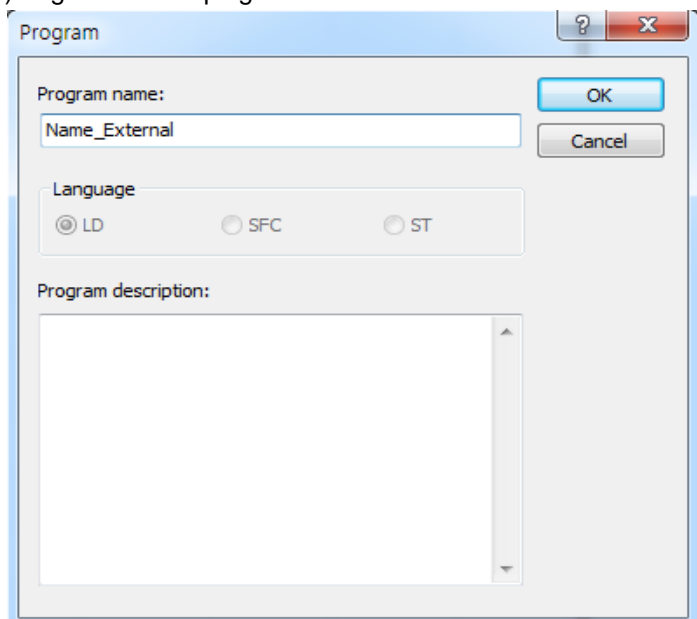

(e) If the program window for writing the task program is displayed, you can make the task program here.

(3) Instructions to use the external contact task

When the rising, falling or transition conditions occur in the set input contact, the corresponding external contact task program runs and keep the below instructions in mind.

- 8 external contacts are available in the range of P0008~P000F.
- When the specific external contact task program runs currently or stands by for execution, if the request on running the same input task program occurs, the newly occurred task will be ignored.
- The input contact monitoring for the external contact tasks is executed only when the operation mode is RUN mode. The input contact monitoring for task startup is not executed in STOP mode.
- The detection delay time of the external contact task is approximately 50us.
- When designing the system, several external contact tasks should not start at the same time. If P0008 ~ P000F contacts are ON at the same time under all the external contacts of P0008 ~ P000F are set as the external contact tasks, 8 external contact task programs run at one so the scan time may be longer momentarily.

Chapter 1 Configuration and Operation Mode of Programs

1.1.9 Internal device task

(1) How to set up the task

- (a) Adding tasks: Select 『Project』 – 『Add Items』 – 『Task』 or after clicking with the right mouse button on the project name of the project tree, select 『Add Items』 - 『Task』 as shown in the below figure.

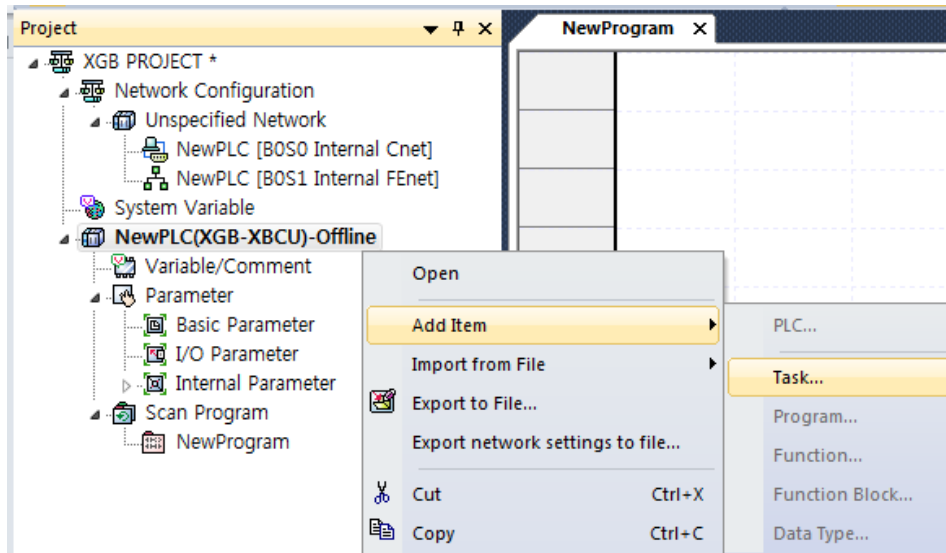

- (b) The screen for registering the task will be displayed. Click 『Internal device』 in the execution conditions and after entering the task name, input the items required for setting as below.

Items		Input range	Description	
Priority		2~7	Designates the priority of tasks..	
Task No.		24~39	Designates the task number. The numbers overlapped with are not available.	
Internal device		BIT, WORD	Selects the device type that will start the task.	
Device		Direct input	Input directly the device that will start the task and set the startup conditions.	
Startup conditions	Bit	Rising, falling, transition, On, Off	Rising	Starts the task in case of rising edge.
			Falling	Starts the task in case of falling edge.
			Transition	Starts the task in case of rising or falling edge.
			On	Starts every scan task during ON.
			Off	Starts every scan task during OFF.
	Word	<, <=, ==, >=, >	<	Starts the task when the word is less than the set value.
			<=	Starts the task when the word is less than or equal to the set value.
			==	Starts the task when the word is the same as the set value.
			>=	Starts the task when the word is more than or equal to the set value.
			>	Starts the task when the word is more than the set value.

Chapter 1 Configuration and Operation Mode of Programs

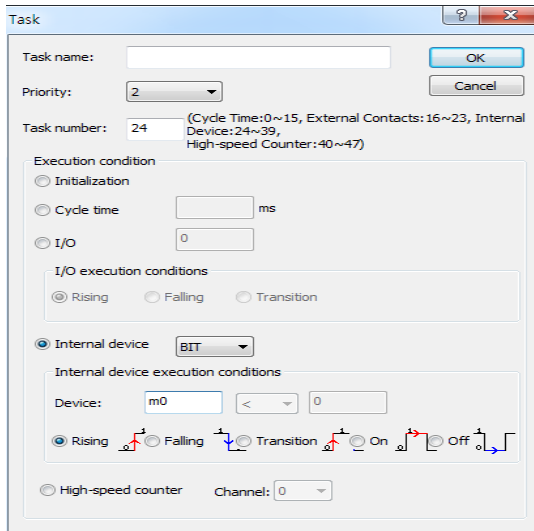

(c) Click on the right mouse button on the registered task and click 『Add Items』 - 『Program』 .

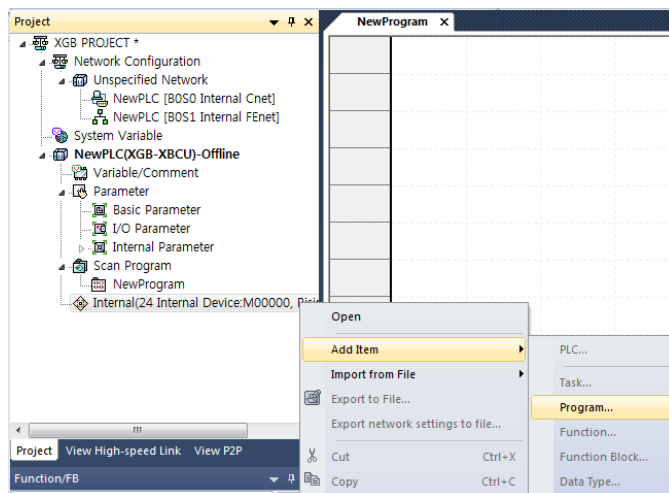

(d) Register the task program name and comment.

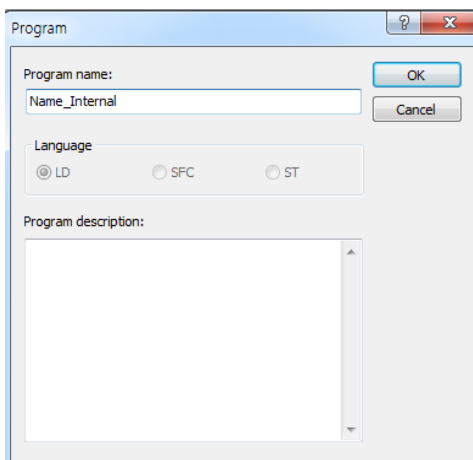

Chapter 1 Configuration and Operation Mode of Programs

(e) If the program window for writing the task program is displayed, you can make the task program here.

(2) Instructions to use the internal device task

The internal contact task detects the startup conditions of the internal device set by the scan END and runs the relevant internal device task program. Keep the below instructions in mind.

- The internal device task program runs when the scan program is completed. Accordingly, although the execution conditions of the internal device task program occur in the scan programs or task programs (fixed cycle, external contact, high speed counter), it will run at the time of completing the scan program instead of running immediately.
- In the case of the internal device task, the execution conditions are searched when the scan program is completed. Accordingly, if the execution conditions of the internal device task occur and dissipate by the scan program or other task programs, the task will not run since the execution conditions cannot be detected at the time of searching the conditions.

1.1.10 High speed counter task

(1) How to set up the task

- (a) Adding tasks: Select 『Project』 – 『Add Items』 – 『Task』 or after clicking with the right mouse button on the project name of the project tree, select 『Add Items』 - 『Task』 as shown in the below figure.

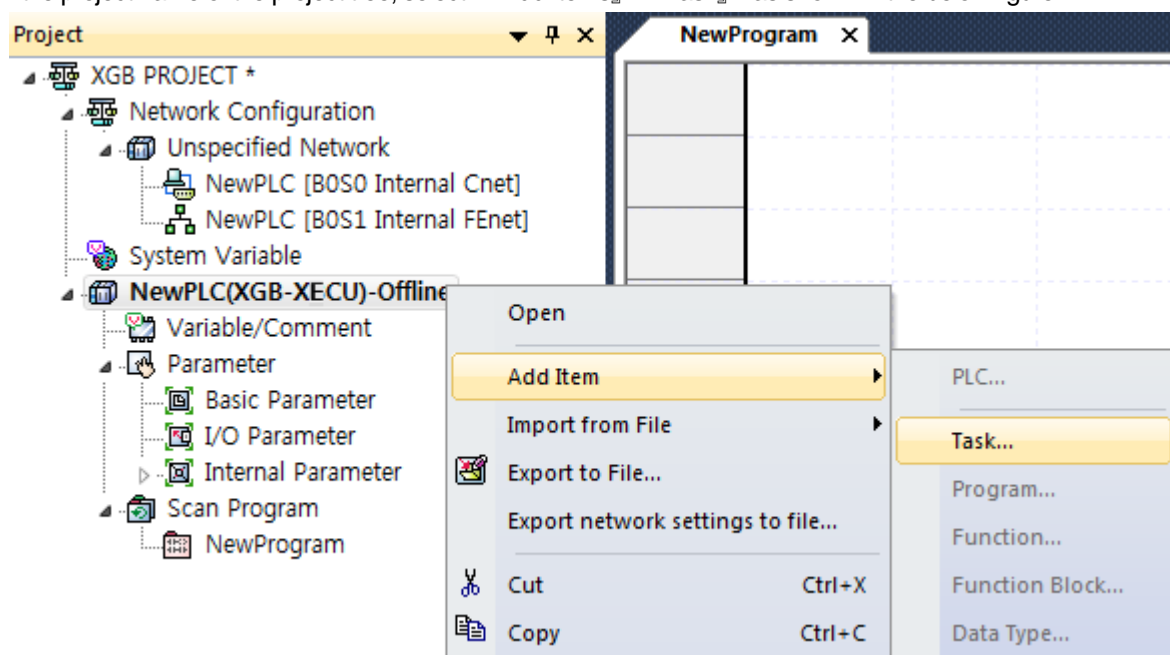

- (b) The screen for registering the task will be displayed. Click 『High speed counter』 in the execution conditions and after entering the task name, select the channel.

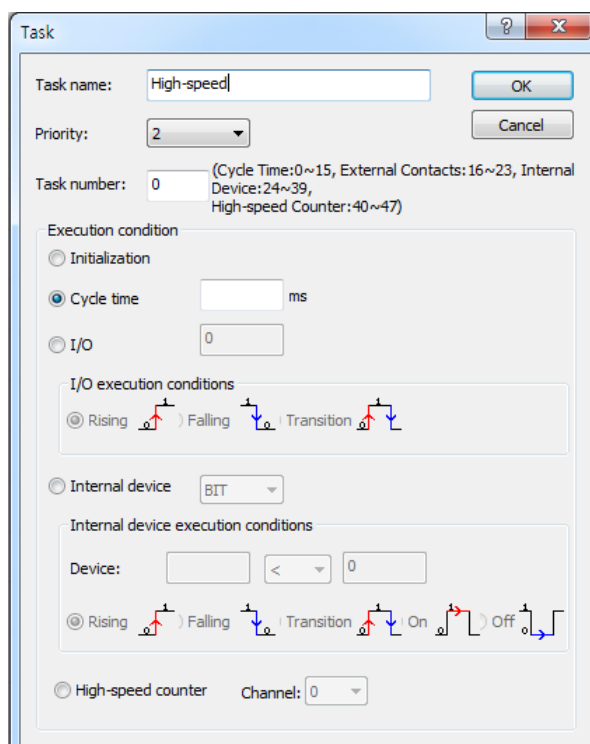

Chapter 1 Configuration and Operation Mode of Programs

(c) Click on the right mouse button on the registered task and click 『Add Items』 - 『Program』 .

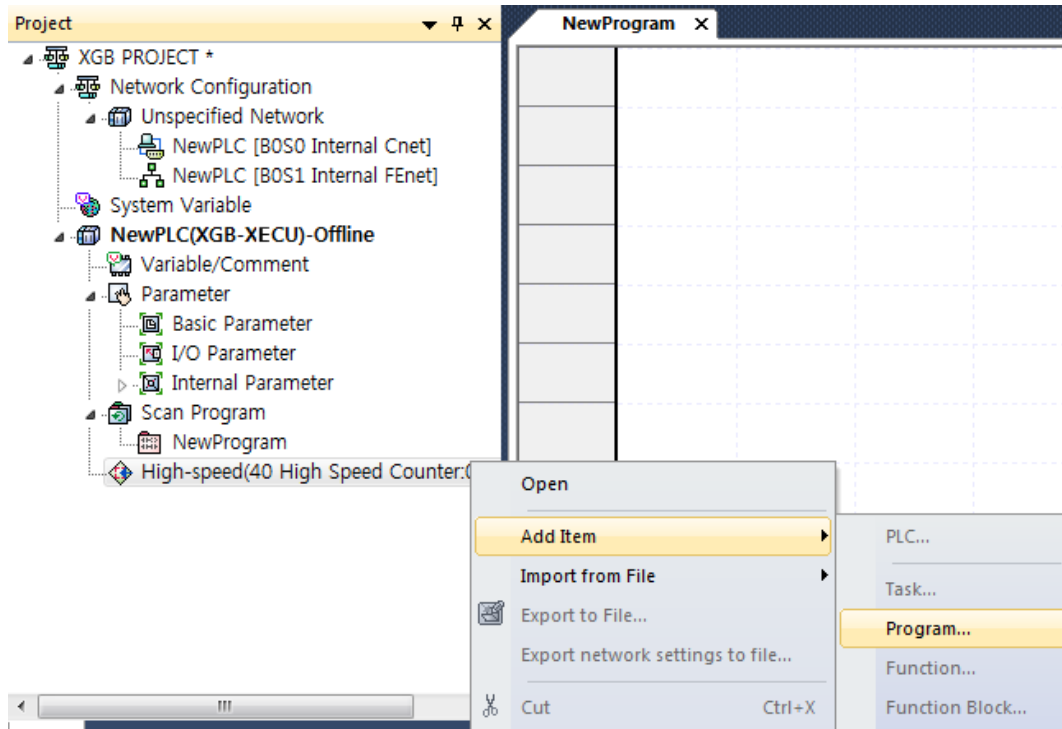

(d) Register the task program name and comment.

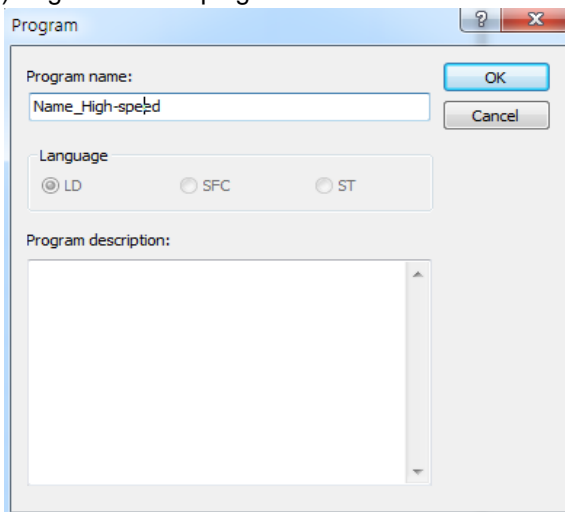

(e) If the program window for writing the task program is displayed, you can make the task program here.

(2) Instructions to use the high speed counter task

- When the high speed counter's current value in the selected channel becomes equal to the comparative output set value of 0 of the relevant channel in the below Fig., the high speed counter task will be detected and the task program will run.
- You can check whether the conditions of the high speed counter task occur at every 250us cycle so detection delay may occur up to 250us.
- The operations of the high speed counter task are performed only when the operation mode is RUN mode.

1.2 Operation mode

The high performance XGB PLC has 3 operation modes; RUN mode, STOP mode, DEBUG mode.

This section describes the execution processing of each operation mode.

1.2.1 RUN mode

It is the mode executing the program normally.

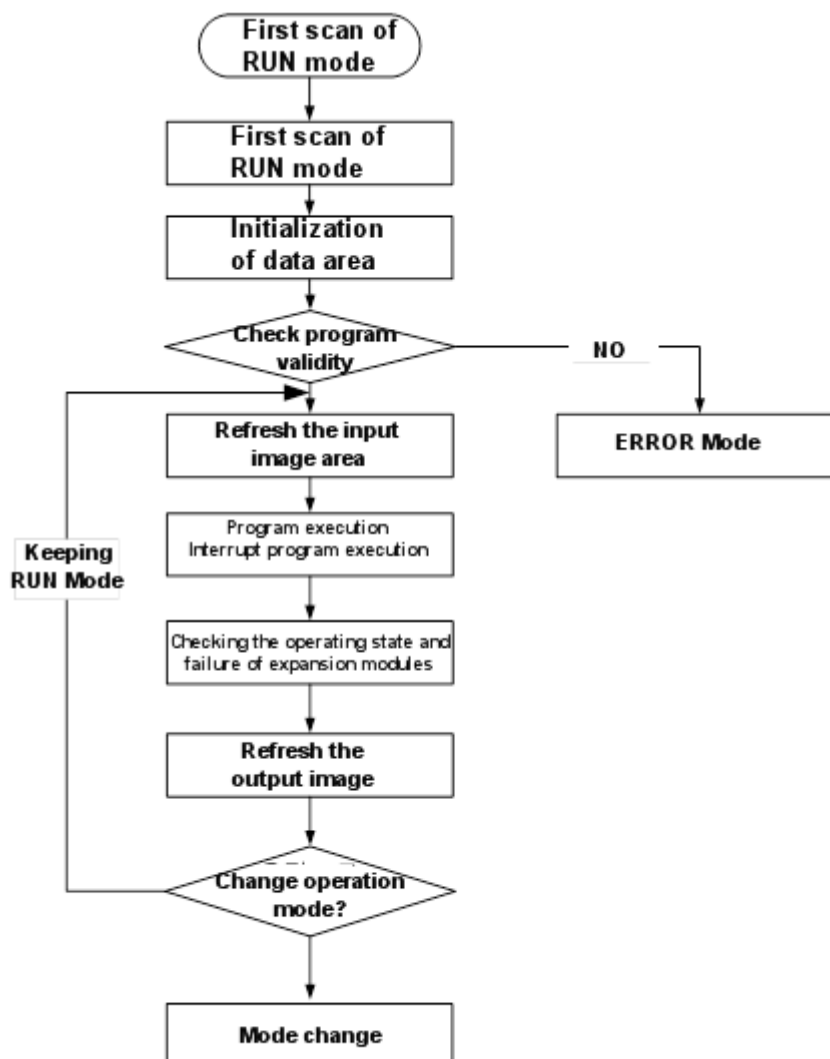

(1) When changing the mode from other into RUN

Initialize the data area at the beginning stage and check the validity of the program to determine whether it can be executed or not.

(2) Execution processing details

I/O Refresh and program operation are executed.

(a) The interrupt program is executed by detecting the startup conditions of the interrupt program.

(b) Normal operation or fail of the equipped module is checked.

Chapter 1 Configuration and Operation Mode of Programs

(c) Communication services are executed with other internal processing.

1.2.2 STOP Mode

It is the mode of block state without operations of the program. In STOP mode, you can write the programs and parameters through XG5000.

- (1) When changing the mode from other into STOP
 - Eliminate the output image area and execute Output Refresh.
- (2) Execution processing details
 - (a) I/O Refresh is executed.
 - (b) Normal operation or fail of the equipped module is checked.
 - (c) Communication services are executed with other internal processing.

1.2.3 DEBUG Mode

It is the mode to find errors of the program or track the operation processes. You can convert the mode into Debug in STOP mode only. Though this mode, you can verify the program by checking the execution status of the program and details of each data.

- (1) When changing the mode from other into DEBUG
 - (a) Initialize the data area at the beginning stage of changing the mode.
 - (b) Eliminate the output image area and execute Input Refresh.
- (2) Execution processing details
 - (a) I/O Refresh is executed.
 - (b) The debug operations will be executed based on the setting status.
 - (c) Output Refresh is executed after debugging until the end of the program.
 - (d) Normal operation or fail of the equipped module is checked.
 - (e) Other services such as communication, etc. are executed.

1.2.4 Change of operation modes

(1) How to change operation modes

You can change the operation mode with the below methods.

- (a) Change by the mode key of the basic unit
- (b) Change by connecting the programming tool (XG5000) to the PLC
- (c) Changing the operation mode of the other basic unit connected to network with XG5000 accessed to the basic unit 1 (remote access)
- (d) Change by using XG5000, HMI, communication module connected to the network
- (e) Change by the 'STOP' command during execution of the program

(2) Kinds of operation modes

The following operation modes are set by the mode setting key of the basic unit and XG5000's commands.

Operation mode switch	XG5000 command	Operation mode	Remarks
RUN	Unchangeable	Local RUN	When the operation mode switch is located in RUN position, the mode change by XG5000 is impossible.
STOP	RUN	remote RUN	
	STOP	remote STOP	
	Debug	Debug	
RUN → STOP	-	STOP	

(a) The mode change by XG5000 is available only when the operation mode switch is in **STOP** state.

(b) If you want to change the mode into 'STOP' with a switch in the remote RUN state by XG5000, operate the switch as STOP → RUN → **STOP**.

Chapter 1 Configuration and Operation Mode of Programs

1.3 Memory

The high performance XGB basic unit has two types of memory for a user. One is the program memory saving the user program that is made by a user to build up the system; another is the data memory providing the device area that saves the data during operation.

1.3.1 Program memory

The user program memory embedded in the high performance XGB PLC is composed as below.

Items	Size (KB)	Details
Parameter setting area	120	<ul style="list-style-type: none"> Basic parameter area I/O parameter area Special, communication module parameter area User event, trace parameter area
Program saving area	1024	<ul style="list-style-type: none"> Scan program area1, 2 Variable/comment area
System area	156	<ul style="list-style-type: none"> User event, trace data area System log area Device backup area
Program backup area	1,362	<ul style="list-style-type: none"> Scan program area Task program area Upload area Parameter initialization area Retain parameter assignment area

1.3.2 Data memory

Data memory is shown as in below.

항 목	용량	
Data memory entire area	212KB	
System area :		
<ul style="list-style-type: none"> I/O information table Forced I/O table Reserved area 	20KB	
Flag area	System flag (F)	4KB
	Analog image flag (U)	768B
	Internal special flag (K)	16KB
	High speed link (L)	8KB
Input image area (%I)	2KB	
Output image area (%Q)	2KB	
R area (%R)	32 KB* 2block	
Direct variable area (%M)	32KB	
Symbolic variable area (maximum)	64KB	

Chapter 1 Configuration and Operation Mode of Programs

(1) Memory block diagram

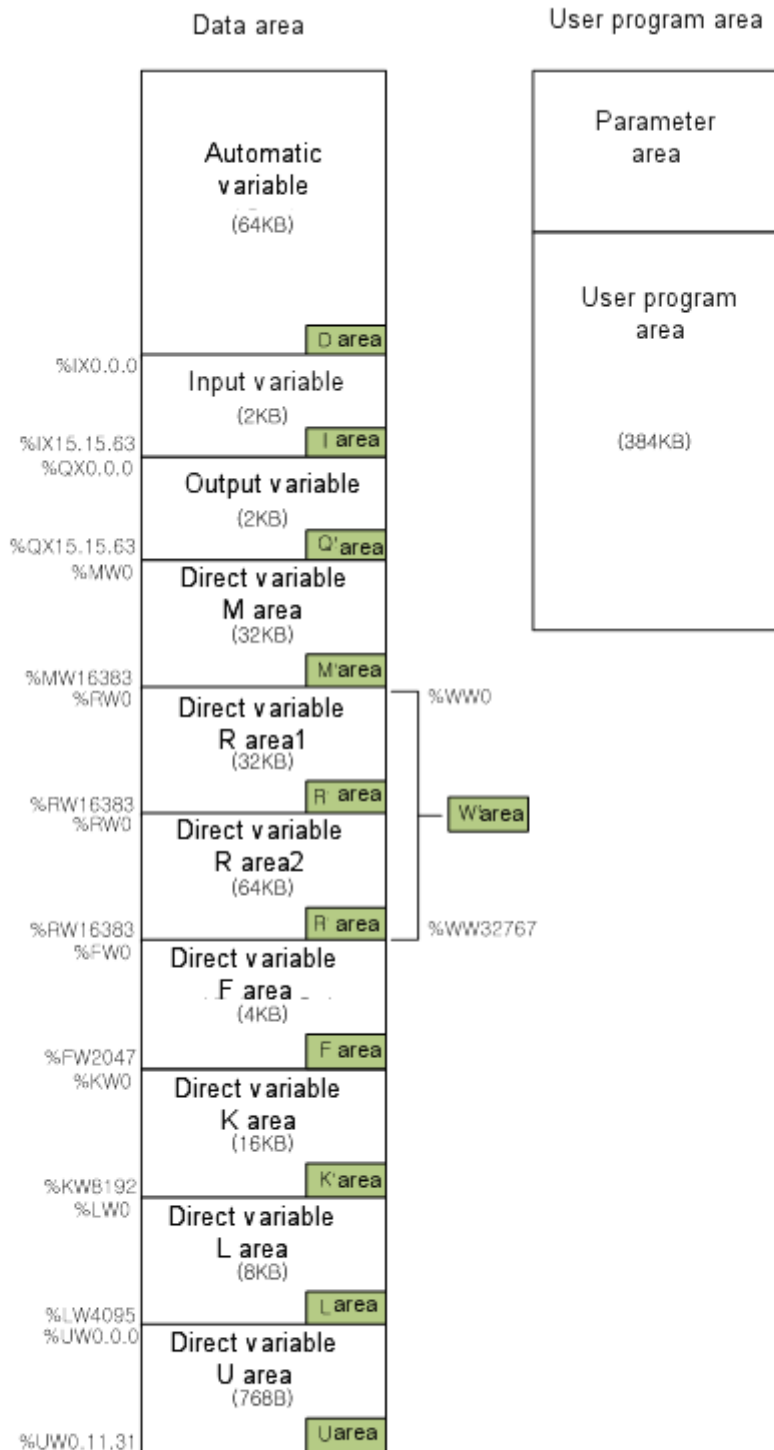

Chapter 1 Configuration and Operation Mode of Programs

1.3.3 Data retain area setting

In case you want to keep the data necessary for operation and the data made during operation when PLC stops and restarts, Default(automatic) Variable Retain is used and some area of M area can be set as Retain area through parameter setting

The following is characteristic table about the device available for Retain setting

Device	Retain setting	Retain	Characteristic
Default	O	Depend on setting	As for automatic variable area, Retain setting is available
M	O		As for internal contact point area, Retain setting is available at parameter
K	X	O	In case of power failure, contact point is kept
F	X	X	System flag area
U	X	X	Analog data register (Retain is not available)
L	X	X	High speed link/P2P service status contact point of communication module (Retain is available)
N	X	O	P2P service address area of communication module (Retain is available)
R	X	O	Flash memory dedicated area (Retain is available)

Remark

- 1) K, N, R devices are retained basically.
- 2) K, L, N devices can be deleted through "Clear PLC" of XG5000 online menu.
- 3) For more detail, refer to "Online" of XG5000 user manual.

(1) Initialization of data according to restart mode

There are three variable related with restart mode (Default, initialization and retain variable). Initialization method about each variable in case of executing restart mode is as follows.

Mode Variable assignment	COLD	WARM
Default	Initialized as '0'	Initialized as '0'
Retain	Initialized as '0'	Hold previous value
Initialization	Initialized as user defined value	Initialized as user defined value
Retain & Initialization	Initialized as user defined value	Hold previous value

(2) Operation of data retain area

Method on deleting the Retain data is as follows.

- RESET through XG5000 (Overall Reset)
- Execute "Clear PLC" through XG5000 at STOP mode
- Writing by program (Initialization program recommended)
- Writing '0' FILL etc at XG5000 monitor mode

Chapter 1 Configuration and Operation Mode of Programs

For holding of retain area data or reset (clear) operation according to PLC operation, refer to the following table.

Classification	Retain	M area Retain	R area
Reset	Hold previous value	Hold previous value	Hold previous value
Overall reset	Initialized as '0'	Initialized as '0'	Hold previous value
STOP→RUN	Hold previous value	Hold previous value	Hold previous value

Remark

- 1) Terms on three types of variable are as follows.
 - (1) Default variable : variable not set as INIT or Retain variable
 - (2) INIT variable : initial value is set
 - (3) Retain variable : Holds previous value

(3) Initialization of data

If PLC becomes 'Clear Memory' status, memory of all devices are deleted as '0'. When you want to specify initial value, use initialization task. At CPU module, there are two types of built-in memory. One is program memory to save program made by user, for user to structure system, Another is data memory providing device area saving data during operation.

Chapter 2 CPU Function

2.1 Type Setting

This section describes setting XGB PLC models.

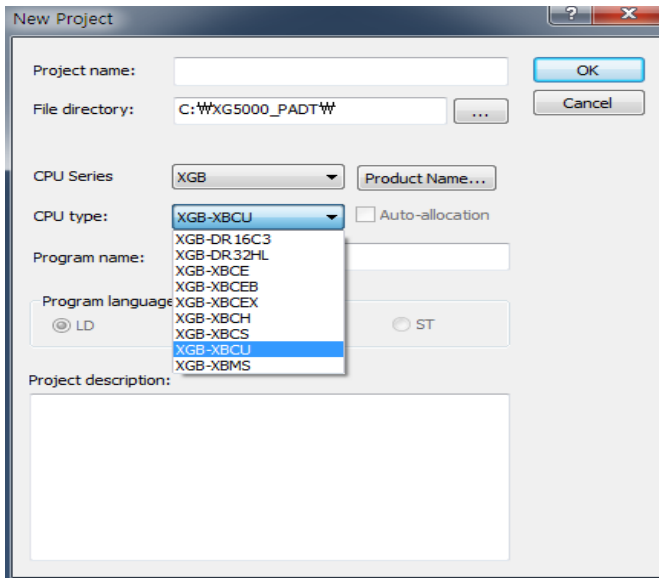

PLC Name	CPU Type	Language	Description	Remarks
XGB	XGB-XECE	IEC language	Economic : XEC-R10/14/20/30E XEC-DN10/14/20/30E, XE-DP10/14/20/30E	Compact type
	XGB-XECH	IEC language	Deluxe: XEC-DR32/64H, XEC-DN32/64H XEC-DP32/64H	Compact type (DC power PLC included)
	XGB-XECS	IEC language	Standard : XE-DR20/30/40/60SU, XE-DN20/30SU/40/60SU	Compact type
	XGB-XEC	IEC language	high performance : XEC-DN32U, XEC-DN32UP, XBC-DN32UA XEC-DP32U, XEC-DP32UP, XBC-DP32UA XEC-DR28U, XEC-DN28UP, XBC- DR28UA	Compact type (DC power PLC included)

2.2 Parameter Setting

This section describes XGB PLC's parameter setting.

2.2.1 Basic parameter setting

If you click the basic parameter in the project window, the below screen will be displayed.

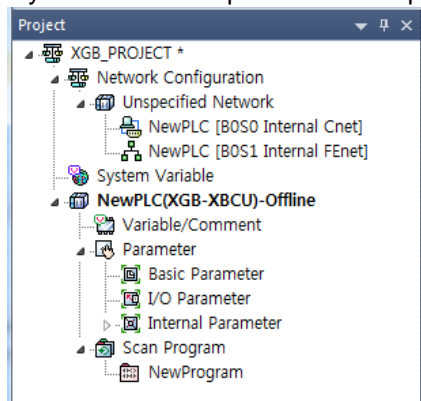

You can set up 3 items; 'Basic operation setting', 'Device area setting', 'Error operation setting'.

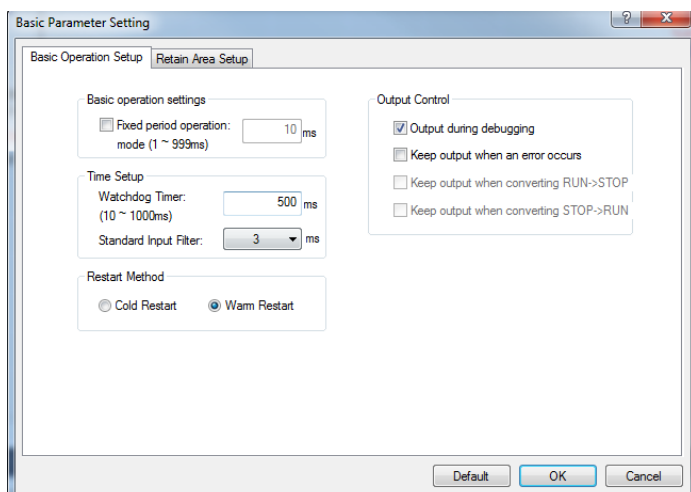

Classification	Items	Descriptions	Set values
Basic operations	Fixed cycle operation	Set the fixed cycle operation time.	1~999ms
	Watchdog timer	Set the scan Watch Dog's time.	10~1000ms
	Standard input filter	Set the standard input filter's time.	1,3,5,10,20,70,100ms
	Restart method	Set the restart mode	Cold ,warm
	Output during debugging	Set whether allowing the actual output during debug operation.	Allowable/Prohibited
	Output Hold when errors occur	Determine whether allowing the Output Hold function set in I/O parameters when errors occur	Allowable/Prohibited
Retain area setup	Retain setting	Set the M retain area	%MW0~%MW8191

Chapter 2 CPU Function

2.2.2 I/O parameters Setting

It is the function to set up and reserve the information for each I/O. If you click 『I/O Parameter』 in the project window, the below setting window will be displayed.

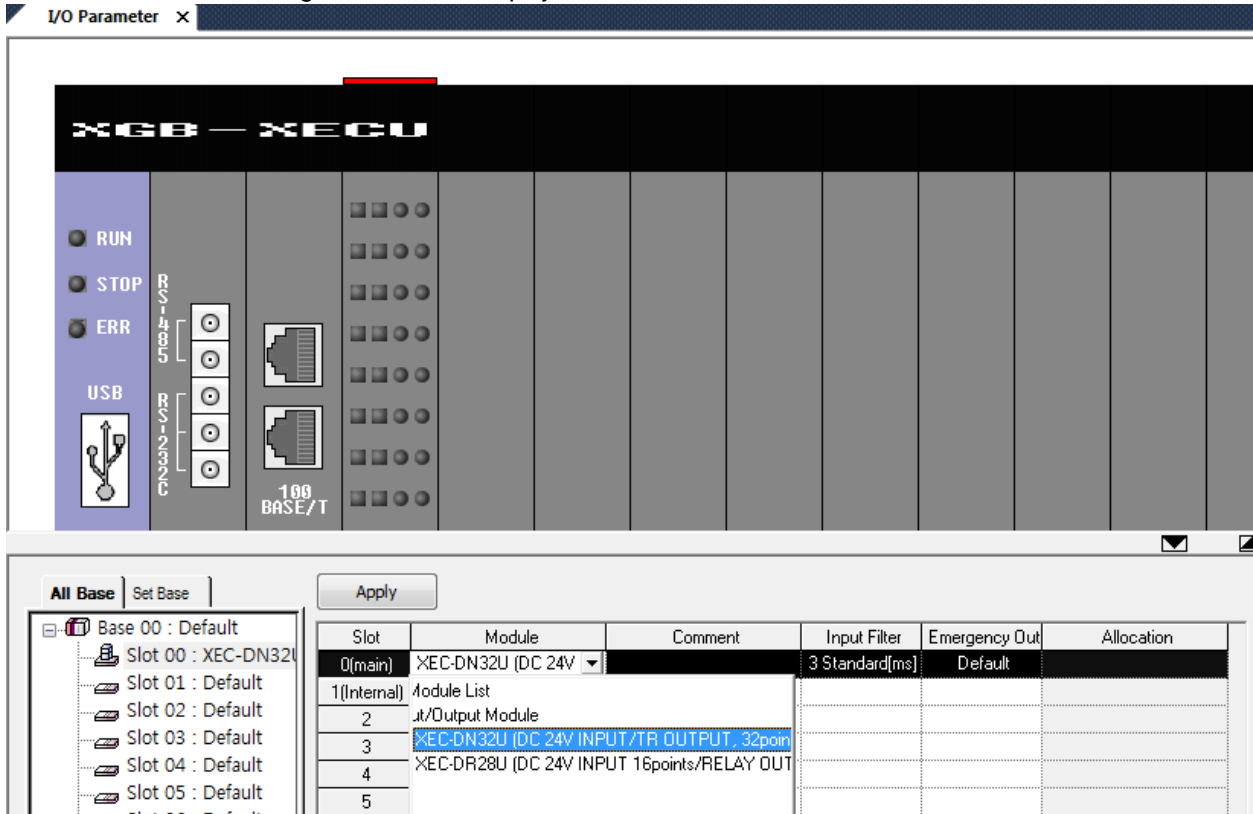

If you click the 『Module』 in the 『slot』 position, the list of each module will be displayed. Then, choose the module that is matched with the actual system to be configured. The selected slot will be displayed as below.

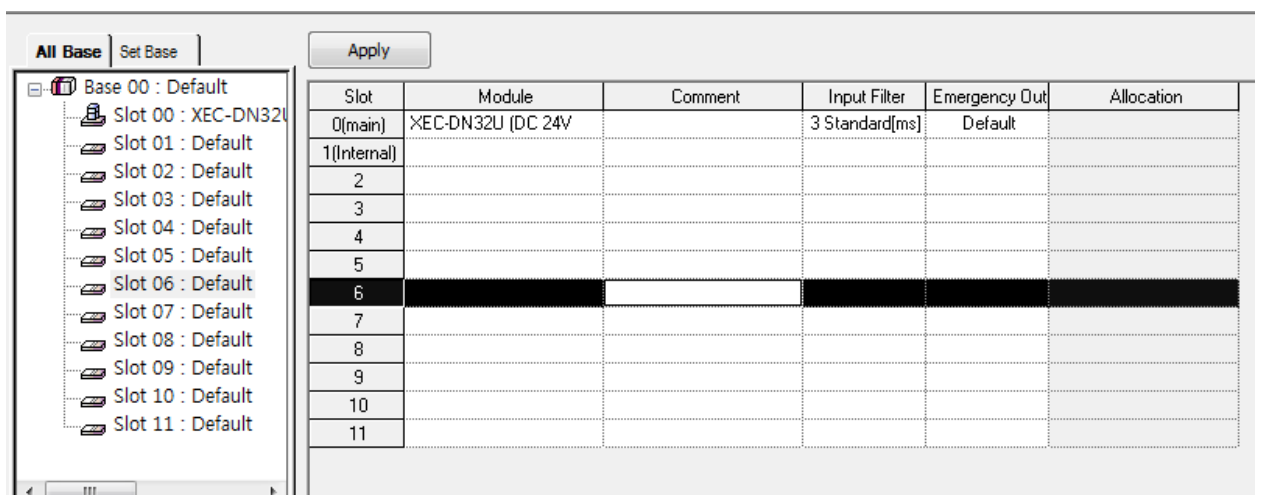

If you press 『In Detail』 button on the slot image or the relevant slot position in the base window as below, the window for setting the filter, emergency output will be displayed.

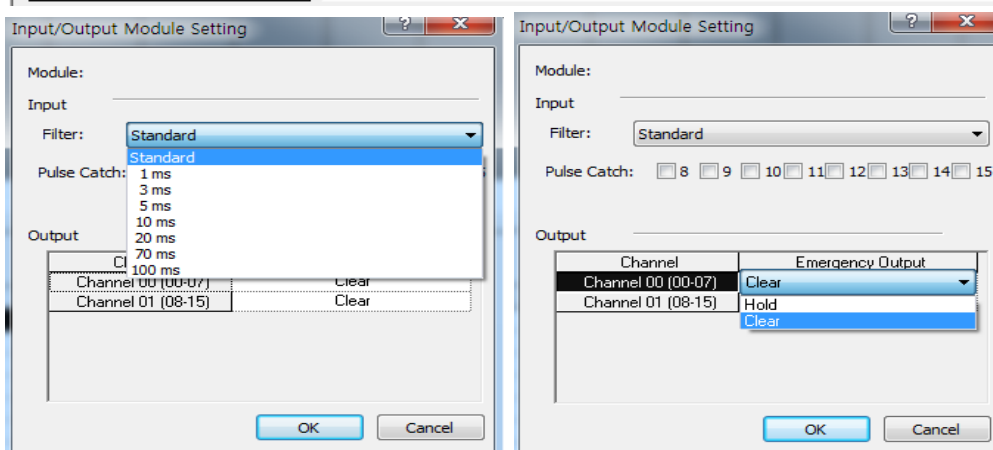
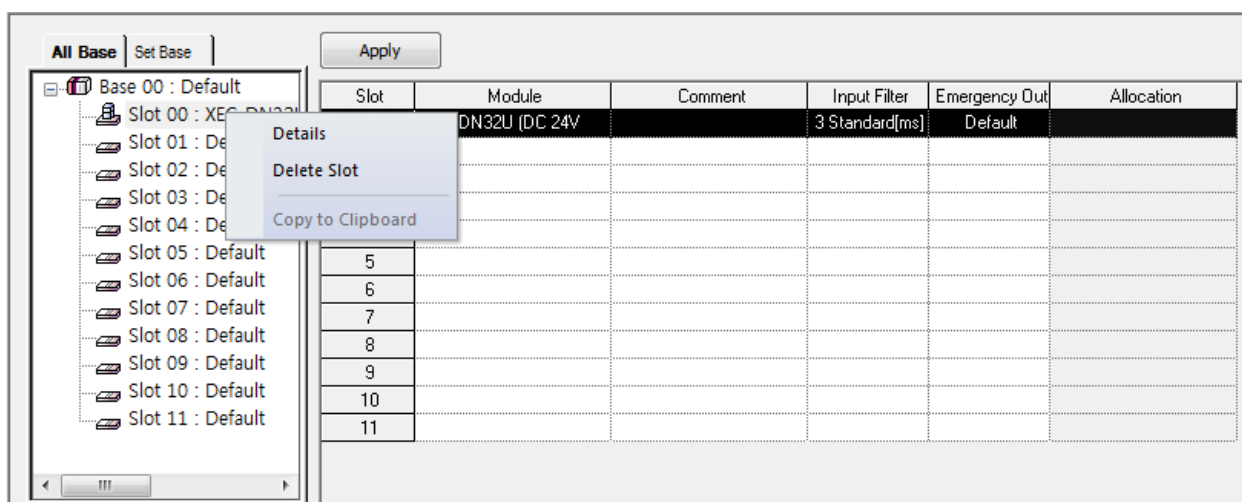
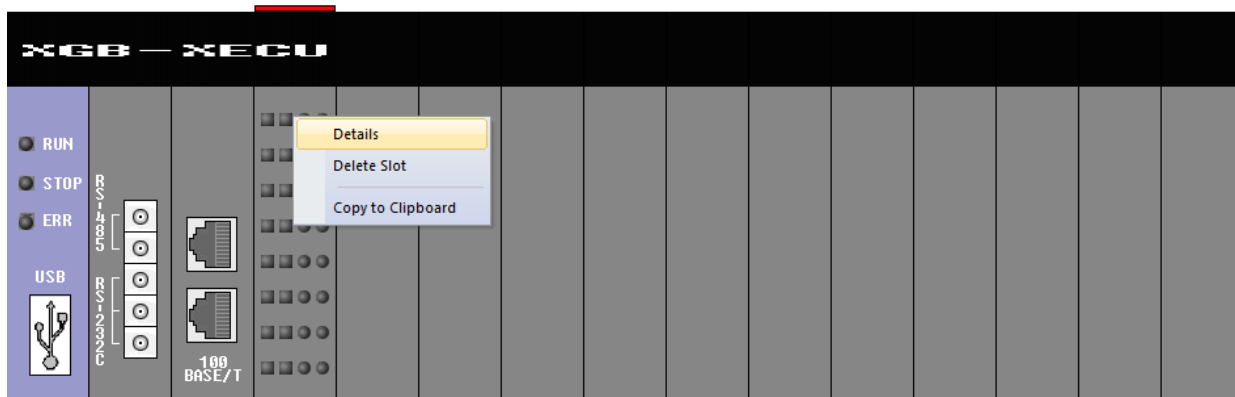

Notice

- In case each set details are different from the actually accessed I/O module, 'Module Type Mismatch Error' occur and the error will be displayed.
- If there is no setting, the CPU reads each I/O module's information for operation.

Chapter 2 CPU Function

2.3 Self-Diagnosis Function

The Self-Diagnosis function is the function for the CPU part to diagnose the PLC system for defects. In case errors occur during supplying the power to the PLC system or during operation, it detects errors to prevent malfunction of the system and preventive maintenance.

2.3.1 Scan Watchdog timer (Scan Watchdog Timer)

The WDT (Watchdog Timer) is the function to detect the congestion of programs caused by PLC module's hardware or software.

(1) The Watchdog timer is the timer to be used to detect operation delay caused by the user program error. You can set up the Watchdog timer's detection time in XG5000's basic parameters as below (Initial value: 500ms).

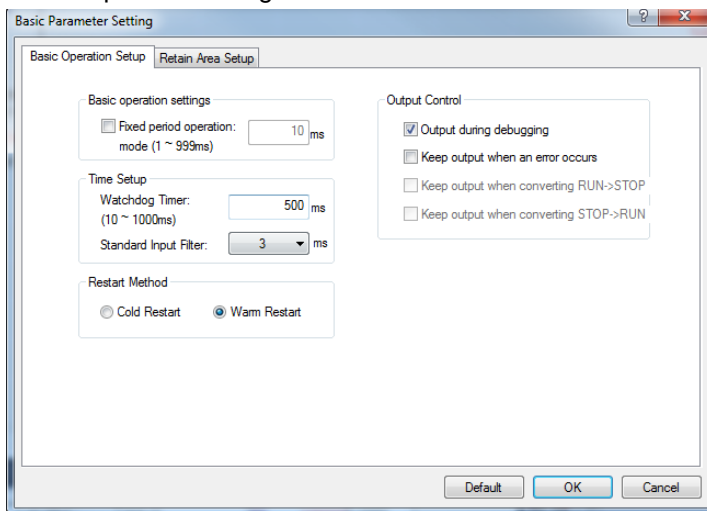

- (2) The Watchdog timer monitors the scanning time during operation and when set detection time is exceeded, it stops the PLC's operations immediately. At this time, the output status is maintained or cleared based on the details of 'Output Hold when errors occur'.
- (3) If it is expected that the Scan Watchdog Time is exceeded since it takes more time to process the specific part of the user programs (in case of using FOR ~ NEXT command, CALL command, etc.), clear the Watchdog timer through the 'WDT' command.

The 'WDT' command initializes the scan Watchdog time and restarts measuring time from 0.

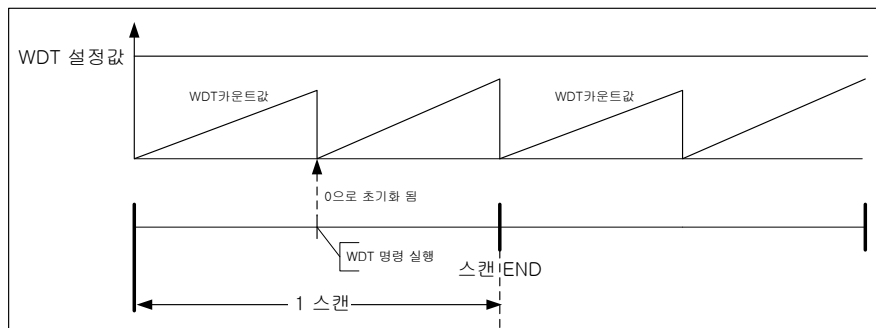

(Example of initializing scan Watchdog timer through the WDT command)

- (4) In case the Watchdog error occurs, you can clear the error by resupplying the power or converting the mode into STOP.

2.3.2 Function to save error history

When errors occur, the high performance XGB basic unit records the error history to clean up causes easily. If you click 『Online』 - 『Error/Warning』, you can see the current errors and the history. Remove the causes of errors referring to the details and corrective measures of each error item.

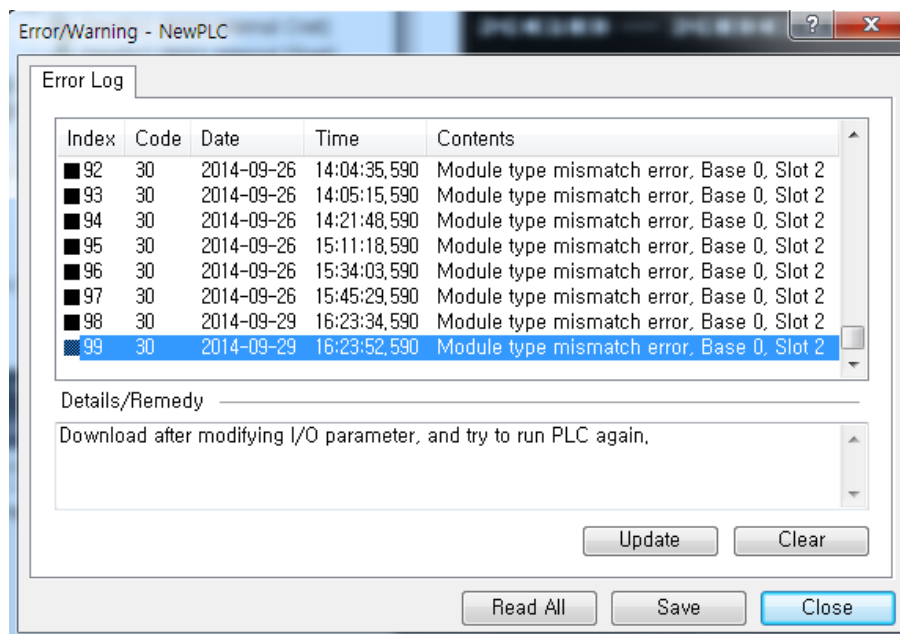

Items	Description	Remarks
Error/Warning	Displays the current Error/Warning.	-
Error history	Displays Error/Warning occurred in order of time.	Saving up to 100

Notice

If you click 'Delete' in the Error/Warning window, all the saved error history will be deleted.
In case the error histories exceed 100EA, the histories are deleted in order from the one that occurred first and the 100EA recent histories are saved

2.3.3 Failure Management

(1) Failure Types

The troubles are caused by failure of the PLC itself, system configuration's error, error detection of operational results, etc. They can be divided into the failure mode stopping the operation for system safety; minor failure mode that informs a user of failure warning and resumes the operation.

The failures of the PLC system are mainly caused by the below.

- PLC hardware's problems
- System configuration's error
- Operational error during execution of user programs
- Detection of errors caused by external device failure

Chapter 2 CPU Function

(2) Operation mode in case of failures

In case failures occur, the PLC system records the failure details in the special flag (F area) and determines whether resuming the operation based on the failure mode.

- In case of the PLC hardware's failure

In case there are problems with the CPU, power, etc. that the PLC cannot work normally, the system will be stopped; In case of minor failures such as a battery's low voltage, the warning is displayed and the operation will be resumed.

- In case of system configuration's error

It is the failure occurred when the actual PLC's module configuration is not matched with the module configuration set in XG5000. The system will be stopped.

- Computational error during execution of user programs

In case of the numeric operation error (Ex.: in case the denominator of division operation is 0) occurred during execution of user programs, the details will be displayed in the error flag and the system will resume the operation. If the operational time exceeds the operation delay monitoring set time during operation or equipped I/O modules cannot be normally controlled, the system will be stopped.

- Detection of errors caused by external device failure

The failure of the external control device can be detected by the PLC's user program; in case of detecting failures, the system will be stopped; in case of detecting minor failures, only the detection status will be displayed and the operation will be continued. (For the detailed use of the function to detect external device's failures, refer to the 2.3.6 Failure Diagnosis Function for the External Device.)

The information on failures occurrence is saved in the special relay (F area). Among F area flags, the information related to the failures are as below.

Word	Bit	Flag Name	Function	Description
%FW0	%FX2	_ERROR	ERROR	ERROR status
%FW2~3	-	_CNF_ER	System error	Reports the failure status of the system.
	%FX33	_IO_TYER	Module type error	The module type is not matched.
	%FX34	_IO_DEER	Module separation error	The module is separated.
	%FX36	_IO_RWER	Module I/O error	There are some problems with the module I/O.
	%FX37	_IP_IFER	Module interface error	There are some problems with the special / communication module interface.
	%FX38	_ANNUM_ER	External device failure	Failures are detected from the external device.
	%FX40	_BPRM_ER	Basic parameters	There are some problems with the basic parameters.
	%FX41	_IOPRM_ER	IO parameters	There are some problems with I/O parameters.
	%FX42	_SPPRM_ER	Special module parameters	Abnormal special module parameters
	%FX43	_CPPRM_ER	Communication module parameters	Abnormal communication module parameters
	%FX44	_PGM_ER	Program error	There are some errors with the program.
	%FX45	_CODE_ER	Code error	There are some errors with the program code.
	%FX46	_SWDT_ER	System Watch dog	The system Watchdog works.
%FX48	_WDT_ER	Scan Watch dog	The scan Watchdog works.	

Word	Bit	Flag Name	Function	Description
%FW4		_CNF_WAR	System warning	Reports the minor failure status of the system.
	%FX65	_DBCK_ER	Backup error	There are some problems with data backup.
	%FX67	_ABSD_ER	Shutdown caused by abnormal operation	Stoppage caused by abnormal operation.
	%FX68	_TASK_ER	Task collision	Task collision occurrence
	%FX69	_BAT_ER	Battery error	Low battery voltage
	%FX70	_ANNUM_WAR	External device failure	Minor failures are detected from the external device.
	%FX72	_HS_WAR1	High speed link1	High speed link – more than parameter1
	%FX73	_HS_WAR2	High speed link2	High speed link – more than parameter2
	%FX74	_P2P_WAR1	P2P parameter1	P2P – more than parameter1
	%FX75	_P2P_WAR2	P2P parameter2	P2P – more than parameter2
	%FX76	_P2P_WAR3	P2P parameter3	P2P – more than parameter3
F011		_CONSTANT_ER	Fixed cycle error	Fixed cycle error
		_LOGIC_RESULT	Logic result	Displays the logic result.
	%FX176	_ERR	Operational error	It Is On during 1 scan in case of operational error.
	%FX179	_ALL_Off	All outputs Off	It is On when all outputs are Off.
	%FX181	_LER	Operational error latch	It maintains 0 in case of operational error.
%FW15	-	_PUTGET_ERR0	PUT/GET error 0	main base PUT / GET error
%FW23	-	_PUTGET_NDR0	PUT/GET completion 0	main base PUT / GET completion
%FD30	-	_REF_COUNT	Refresh	Increases when executing module REFRESH
%FD31	-	_REF_OK_CNT	Refresh OK	Increases when module REFRESH is normal.
%FD32	-	_REF_NG_CNT	Refresh NG	Increases when module REFRESH is abnormal.
%FW90	-	_IO_TYER_N	Mismatch slot	Displays the slot number with the mismatch module type.
%FW91	-	_IO_DEER_N	Slot with separated module	Displays the slot number with the separated module.
%FW93	-	_IO_RWER_N	RW error slot	Displays the slot number with module Read/Write error
%FW95	-	_IP_IFER_N	IF error slot	Displays the slot number with module interface error
%FW96	-	_IO_TYER0	Module type 0 error	Main base's module type error
%FW104	-	_IO_DEER0	Module separation 0 error	Main base's module separation error
%FW120	-	_IO_RWER0	Module RW 0 error	Main base's module Read/Write error
%FW128	-	_IO_IFER_0	Module IF 0 error	Main base's module interface error
%FW202	-	_ANC_ERR	Information on the external device's failure	Displays the information on the external device's failure
%FW203	-	_ANC_WAR	Information on the external device's minor failure	Displays the information on the external device's minor failure

Notice

- For more details on the whole flags, refer to the Appendix 1 Flag Table of the Outline of this manual.

Chapter 2 CPU Function

2.3.4 Function to check the battery voltage

It is the function to detect and inform the fact that the battery voltage is lower than the memory backup voltage. When a battery low voltage, the ERR LED of the voltage unit is flickering at 1 second interval and F0045 (`_BAT_ER`) flag is On. In this case, you need to change the battery referring to 3.4.4 How to change a battery of the Outline of this manual.

2.3.5 Function to check the expansion module

It is the function to check whether I/O modules work normally during startup and operation. It checks the status of every scan expansion module and the PLC checks whether the following situations occur.

- In case the module that is different from the set parameter is installed at the time of initial operation or failure is suspected
- In case expansion modules are detached or failure is suspected.

If abnormal conditions are detected, the basic unit's ERR LED will be flickering and the PLCU will be stopped.

2.3.6 Failure Diagnosis Function for the External Device

It is the function to detect the failure of the external device connected to the PLC to realize stoppage of the system and warning easily. Through this function, you can detect the external device's failure without complex programming and can monitor the failure position without special devices (XG5000, etc.) or programs.

You can use the failure diagnosis function for the external devices as below.

(1) Failure types of external devices

- The failures of external devices are divided into the two types; failure (error) detected by combination of user programs and special relay (F area) requires stoppage of the PLC operation; minor failure (warning) that continues the PLC's operation and displays the detection status only.

(2) Flag to detect failures of external devices

The following flag types are used to diagnose failures of external devices.

Word	Bit	Flag Name	Function	Description
%FW202	-	<code>_ANC_ERR</code>	Information on the external device's failures	Input the error code of user-defined serious failure of external device.
%FW203	-	<code>_ANC_WAR</code>	Information on the external device's MINOR failures	Input the error code of user-defined minor failure of external device.
-	%FX38	<code>_ANNUM_ER</code>	detection of external serious error	It is On when the external device's serious failure occurs.
-	%FX70	<code>_ANNUM_WAR</code>	detection of external slight error	It is On when the external device's minor failure occurs.
-	%FX3202	<code>_CHK_ANC_ERR</code>	Request detection of external serious error	It is the command flag asking to detect the external device's serious failure.
-	%FX3203	<code>_CHK_ANC_WAR</code>	Request detection of external slight error minor failure	It is the command flag asking to detect the external device's minor failure.

(3) How to detect the external device's serious failures

The following programming is used to detect the external device's serious failures.

- Save the error code that can be distinguished by external device's serious failures in %FW202 (`_ANC_ERR`) through the MOVE command as below. (Input the values excluding 0)
- In case the external device's serious failures occur, %FX3202(`_CHK_ANC_ERR`) flag will be On.
- When the scan program is completed, the PLC checks whether %FX3202 (`_CHK_ANC_ERR`) is ON and detects serious failures.
- If the external device's serious failures occur, the PLC will be in error status and will stop the operation. Then, %FX38 (`_ANNUM_ER`) is ON and %FX3202 flag is automatically Off. All outputs works based on IO parameter's emergency output settings.
- When failures occur, through XG5000, a user can figure out the causes of failures by monitoring %FW202 (`_ANC_ERR`) flag.
- The below figure describes the example of the program detecting the external device's serious failures with operation details.

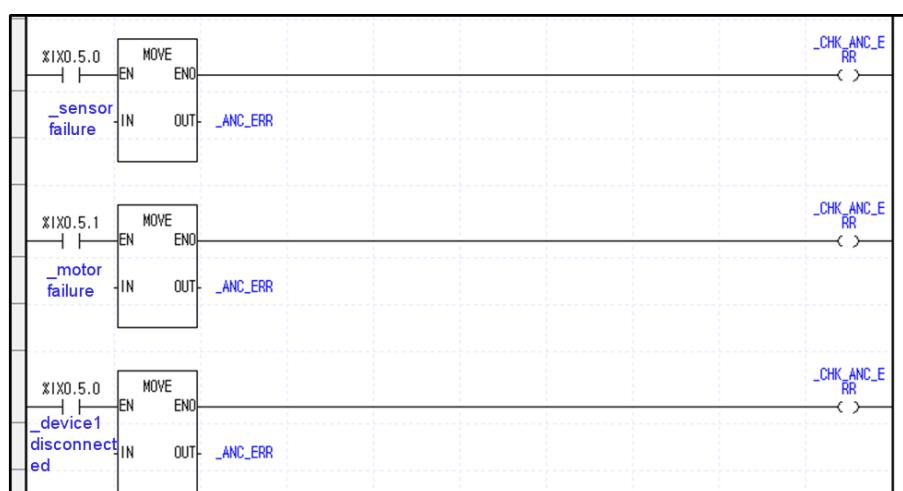
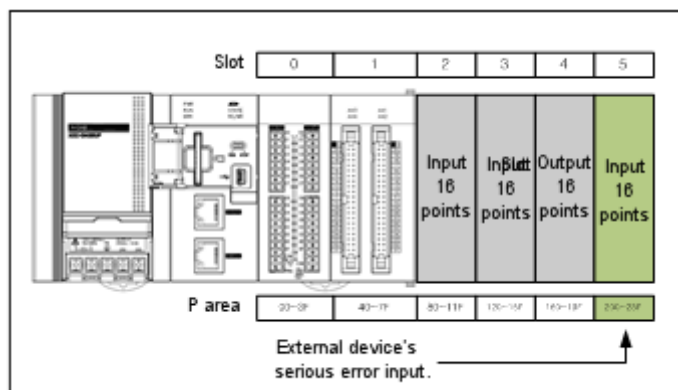

<Example of the system configuration and program >

- In this example, assume that the input signal to detect the external device's failures is connected to the input module of No.5 slot in the system configuration as below.
 - In case of the sensor failure, %IX0.5.0 is ON. The error code is the value saved in _sensor failure.
 - In case of the motor failure, %IX0.5.1 is ON. The error code is the value saved in _motor failure.
 - When the device 1 is disconnected, %IX0.5.2 is ON. The error code is the value saved in _device1 disconnected.
- In the above programming, when %IX0.5.0 is On (In case of sensor failure), the value of D000 is saved in %FW202 (_ANC_ERR) and %FX3202 (_CHK_ANCERR) will be On.
- If %FX3202 is ON, it is detected by the scan end and the external device's serious failures are generated.
- You can detect the failure of motor 1, disconnection of device 1 in the same way.
- After accessing to XG5000, a user can check which external devices have failures by verifying the %FW202 value and can take follow-up measures.

(4) How to detect the external device's minor failures

The following programming is used to detect the external device's minor failures.

- Save the warning code that can be distinguished by external device's minor failures in %FW203 (_ANC_WAR) through the FWRITE command as below. (Input the values excluding 0)
- In case the external device's minor failures occur, %FX3203 (_CHK_ANCERR) flag will be On.
- When the scan program is completed, the PLC checks whether %FX3203 (_CHK_ANCERR) is ON and detects minor failures.

Chapter 2 CPU Function

- (d) If the external device's minor failures occur, the ERR LED will be flickering at 2 seconds interval and the PLC will run continuously. Then, %FX70 (_ANNUM_WAR) is ON and %FX3203 flag is automatically Off. All outputs works based on IO parameter's emergency output settings.
- (e) When minor failures occur, through XG5000, a user can figure out the causes of failures by monitoring %FW203(_ANC_WAR)flag.
- (f) If you input 0 again to %FW203 (_ANC_WAR) after removing the causes of failures and turn ON%FX3203 (_CHK_ANC_WAR) again, detection of minor failures is canceled.
- (g) The below figure describes the example of the program detecting the external device's minor failures with operation details.

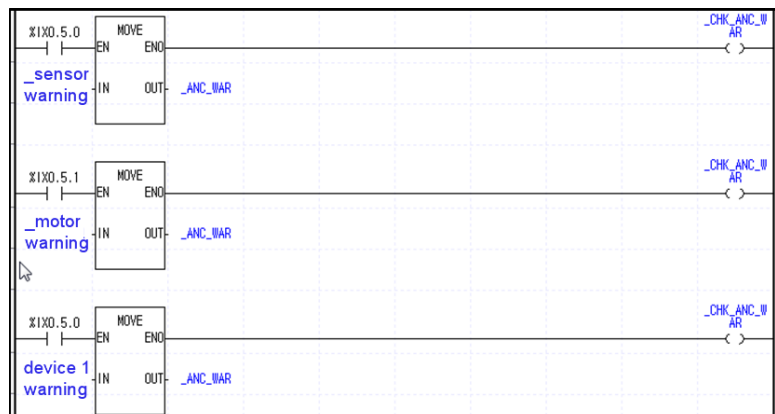
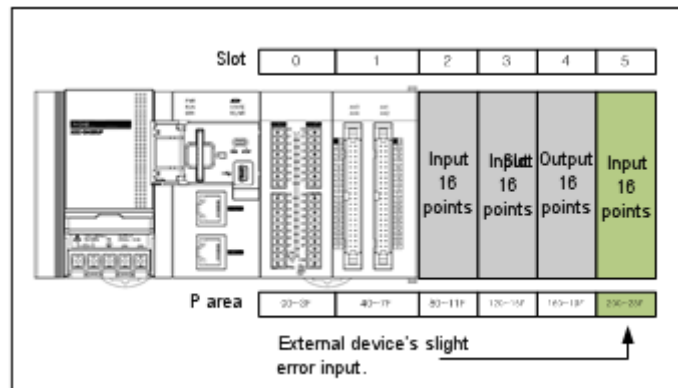

< Example of the system configuration and program >

- In this example, assume that the input signal to detect the external device's minor failures is connected to the input module of No.5 slot in the system configuration as below.
 - In case of the sensor warning, %IX0.5.0 is ON. The warning code is the value saved in _sensor warning.
 - In case of the motor warning, %IX0.5.1 is ON. The warning code is the value saved in _motor warning.
 - When the device 1 is warned, %IX0.5.2 is ON. The warning code is the value saved in device 1 warning.
- In the above programming, when %IX0.5.0 is On (in case of sensor failure), the value is saved in %FW203 (_ANC_WAR) and %FX3203 (_CHK_ANC_WAR) will be On.
- If %FX3203 is ON, it is detected by the scan end and the external device's serious failures are generated.
- You can detect the warnings on motor 1 and device 1 in the same way.
- After accessing to XG5000, a user can check which external devices have minor failures by verifying the %FW203 value and can take follow-up measures.

2.4 RTC Function

The high-performance XGB basic unit has the embedded clock (RTC) function that keeps running by battery backup even when the power is off. The time data of the embedded RTC can be used for time management such as the system's operating history or failure history, etc. The RTC's current time is updated every scan by the flags for the system's operating state information.

2.4.1 How to use the RTC

(1) Reading/Setting clock data

(a) Reading the data from XG5000 and setting

- 1) Click 『Online』 - 『Diagnosis』 - 『PLC information』 .
- 2) Click the PLC clock tab of 『PLC information』 .

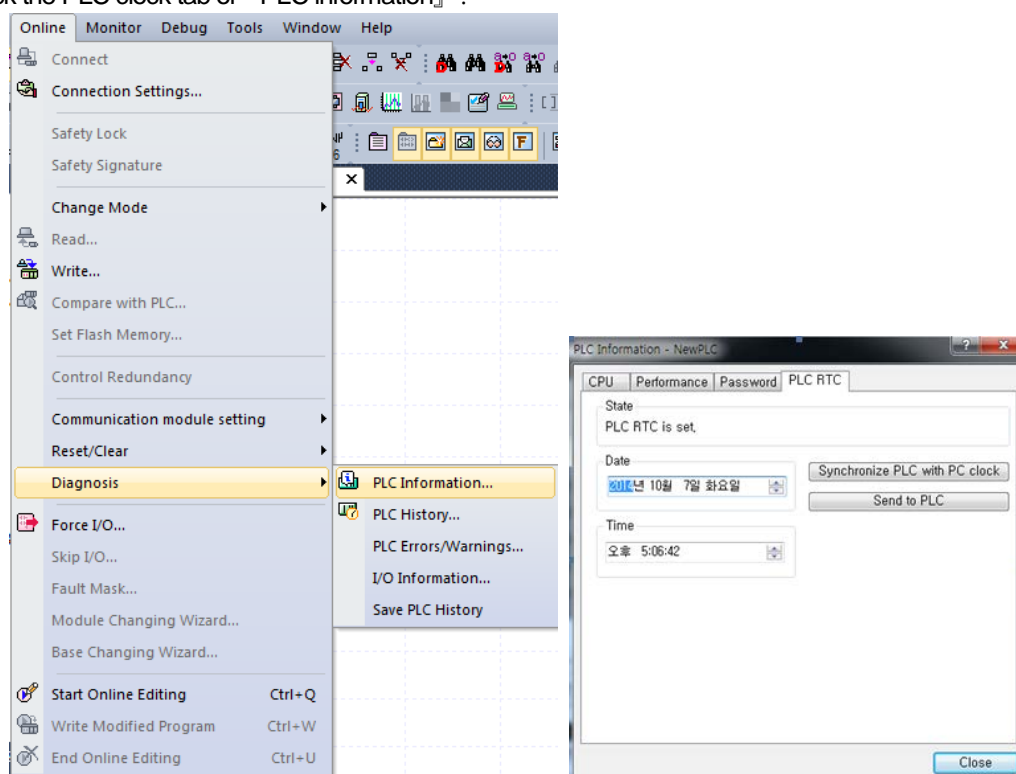

3) If you want to send the time of the PC to the PLC, click 'Synchronization with PC clock' button.

4) If you want to set up the user defined time, after changing set values of the data and time box, click 'Send to PLC'.

(b) Reading with the special relay

You can monitor the data by the special relay as shown in the below example.

Word	Flag Name	Name	Data	Description
%FW53	_MON_YEAR	Clock data(month/year)	H0709	Sep, 2007
%FW54	_TIME_DAY	Clock data(hour/day)	h1214	14:00, 12 th
%FW55	_SEC_MIN	Clock data(second/minute)	H2040	20 minutes 40 seconds
%FW56	_HUND_WK	Clock data(century/day of week)	H2003	2000s,Wed.

Chapter 2 CPU Function

(c) Example of modifying clock data through the program

A user can set up the clock data through the program using RTC-SET function blocks as below.

Function block	I/O variable	Description
	REQ	It executes the function block in rising edge.
	DATA	Time data to input (Refer to the below table.)
	DONE	If the process is performed normally, 1 is output.
	STAT	In case of error, it outputs error codes.

Variable	Details	Example	Variable	Details	Example
DATA[0]	Year	16#14	DATA[4]	Minute	16#30
DATA[1]	Month	16#03	DATA[5]	Second	16#11
DATA[2]	Day	16#30	DATA[6]	-	-
DATA[3]	Hour	16#12	DATA[7]	Age	16#20

In case of 12:30:11, 30th, Mar, 2014, you do not need to input the separate day data since the day of week corresponding to the date is automatically set up.

(d) Example of modifying clock data through the system flags

You can set up the clock data by filling up the clock data in the below area and turning on %FX3200 (_RTC_WR) without using function blocks.

Word	Flag Name	Name	Setting range
%FW210	_MON_YEAR_DT	Clock information data(month/year)	2000~2099, Jan. ~ Dec.
%FW211	_TIME_DAY_DT	Clock information data(hour/day)	1st~31th, 0:00~23:00
%FW212	_SEC_MIN_DT	Clock information data(second/minute)	0 ~59 minutes, 0 ~59 seconds
%FW213	_HUND_WK_DT	Clock information data(century/day of week)	2000s, 0~6(Sun.~Sat.)

(e) How to express day of the week

Number	0	1	2	3	4	5	6
Day	Sun.	Mon.	Tue.	Wed.	Thu.	Fri.	Sat.

(2) Time error

The RTC's error may be different depending on usual temperature. The error of the high-performance XGB's embedded RTC is ± 2.2 seconds / 1 day at room temperature.

Notice

- The clock data may not be stated when the product is sent out from a factory so you need to set up clock data correctly before using the product.

- If you apply unavailable clock data to the RTC, it will not work normally.

Ex.) 25:00, 32th, 14 month

- In case the RTC stops due to battery problem or errors occur, when you input new clock data to the RTC, the error will be cleared.

2.5 Remote Function

In the high performance XGB basic unit, you can change the operation mode through the key switch attached to the module or through communication. For remote operation, put the basic unit's mode change switch on STOP position.

(1) The kinds of remote operations are as below.

- Access to XG5000 and operation through the USB port installed in the basic unit
- You can operate the other PLCs connected to the network by using the PLC's communication functions when XG5000 is connected to the basic unit.
- You can control the PLC's operation status with HMI software, etc. through the dedicated communication

(2) Remote RUN/STOP

- It is the function to execute RUN/STOP through communication modules through the outside.
- This convenient function can be helpfully used when the PLC is installed in the bad palace to operate or you need to RUN/STOP the CPU modules of a control panel from the outside.

(3) Remote DEBUG

- It is the function to execute DEBUG when the operation mode switch is on STOP position. DEBUG is the function to execute the program operation based on the specified operating conditions.
- This convenient function can be helpfully used when you need to check the program's progress or each data's details during the system's debugging works.

(4) Remote reset

- It is the function to reset the CPU module by remote control when errors occur.
- 'Reset' and 'Overall Reset' are available.

Notice

- For more details on how to operate the remote functions, refer to 'Chap.10 Online' of the XG5000 manual.

Chapter 2 CPU Function

2.6 I/O forced On/Off Functions

The forced I/O function is used to turn On/Off I/O areas by force regardless of the results of program execution.

2.6.1 Forced I/O setting method

Click 『Online』 - 『 Forced I/O setting 』 .

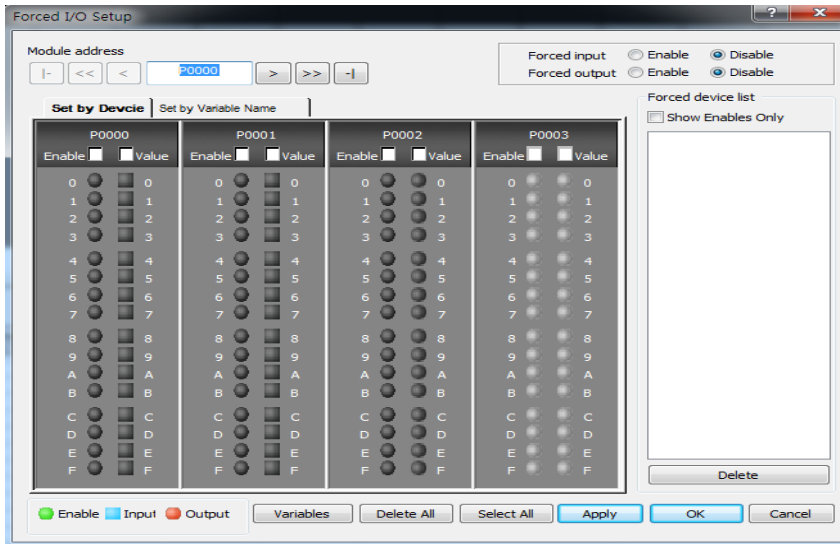

The below table represents the items related to the forced I/O setting.

Item		Description	Remarks
Movement of address		You can select the base and slot.	
Apply		You can set the forced input and output Enable / Unable	
Individual	Flag	You can set the forced I/O Enable / Unable by bit.	
	Data	You can set the forced I/O data (On/Off) by bit.	
View variables/comments		You can check the set input, output variables.	
Select All		You can set the forced I/O Enable under the condition that the whole I/O areas are On.	
Delete All		You can delete the forced I/O Enable under the condition that the whole I/O areas are Off.	
Set device		It displays the I/O area where even one bit is set.	

2.6.2 Time to process the forced I/O On / Off and processing method

(1) Forced input

When the forced input is set, among the data read from the input model at the time of Refresh, the data of the contact set as the forced On/Off is replaced by the forced set data to update the input image area. Accordingly, during program operation, among the actual input data, the forced set area is operated with the results replaced by the forced set data.

(2) Forced output

After completing the operation of user programs, at the time of output Refresh, among the data of the output image areas including the operation results, the data of the contact set as the forced On/Off is replaced by the

forced set data, and then, they are output. Accordingly, in contrast with the forced input, in the case of the forced output, the data of the output image area shows the same data with the program operation results but the actual output changes by the forced output On/Off settings.

(3) Instructions to use the Forced I/O functions

- It work from the time of setting each I/O'Enable' after setting the forced data.
- Although the actual I/O modules are not equipped, the forced input can be set.
- In spite of Off-> On of the power, change of operation modes and operation by the reset key
The previously set On/Off data is stored in the PLC.
- Even in STOP mode, the forced input and output data is not eliminated.
- When you try to set the new data from the beginning, cancel all settings of I/O by using 'Delete All' before use.

(4) Operations in case of errors

- When errors occur after setting the forced output, it works based on 「Output Hold when errors occur」 of output control settings in the basic parameters and 「Emergency Output」 of the I/O parameters. In case of error occurrence, if you select the emergency output as 「Clear」 after setting Output Hold when errors occur」, the output is off when errors occur; if you choose 「Hold」, the output status will be maintained.
- In case 「Output Hold when errors occur」 is not set in the output control setting of the basic parameters, the output is Off.

2.7 Direct I/O Operation Function

I/O contact's Refresh is executed after the scan program is finished. Accordingly, the data of the I/O contact that changes during execution of programs is refreshed to the I/O data of when the END command is executed instead of being refreshed when the data changes.

If you need to immediately refresh the I/O data during execution of the program, through DIFEC_IN, DIREC_OUT command, you can directly read the input contact status for operation or can directly print out the operation results in the output contact.

Block	variable	contents
	EN	When EN=1 Function execute
	BASE	Base number (XGB= 0)
	SLOT	Output module slot number
	MASK_L	Set non-update bit among lower 32bit
	MASK_H	Set non-update bit among higher 32bit
	ENO	When no error, ENO=1
	OUT	When updating output data is finished OUT=1

The below figure indicates the example of the direct I/O operation through the DIFEC_IN, DIREC_OUT command.

Chapter 2 CPU Function

NewProgram[프로그램] x		I/O 파라미터 x	
L0	%IX0.0.0	DIREC_O EN	END
L1	0	BASE	OUT
L2	4	SLOT	
L3	16#FFFF000 0	MASK_ L	
L4	16#FFFFFFF F	MASK_ H	
L5			

- (1) Input base number 0 and slot number 4 where output module is equipped
- (2) Since data to output is 16 bit during scan, enable lower 16 bit among value of MASK_L (16#FFFF0000)
- (3) If execution condition (%IX0.0.0) is On, DIREC_O (Immediate refresh of output module) is executed and data of output module is set as 2#0111_0111_0111_0111.

Notice

- When writing/Reading DIREC_IN, DIREC_OUT in expansion module, it takes 1~2ms times
 - Possibility of Task collision o when using cyclic task or internal task. Which operates in short term of between two input signal.
- For more information refer to XGI/XGB Instruction manual.

2.8 Function saving the operation history

There are 4 types of operation history; error history, mode conversion history, power down history and system history. The occurrence time, frequency, operating details of each event are saved in the memory and you can conveniently monitor the data through XG5000. The operation history is saved in the PLC unless it is deleted through XG5000.

2.8.1 Error history

It saves the error history occurred during operation.

- The error code, date, time, error details are saved..
- The histories can be saved up to 1008 EA.
- It is automatically canceled when the memory backup is cleared due to the battery's low voltage, etc.

2.8.2 Mode conversion history

It saves the information on the changed mode and time when changing the operation mode.

- It saves the data, time, mode conversion details.
- The histories can be saved up to 100 EA.

2.8.3 Power down history

On or Off time of the power is saved as the ON/OFF information.

- ON/OFF information, date and time are saved.
- The histories can be saved up to 100 EA.

2.8.4 System history

It saves the operation history of the system occurred during operation.

- The date, time and details of operation changes are saved.
- The histories related to system operation are saved; XG5000 operation information, change of the key switch position, etc.
- The histories can be saved up to 100 EA.

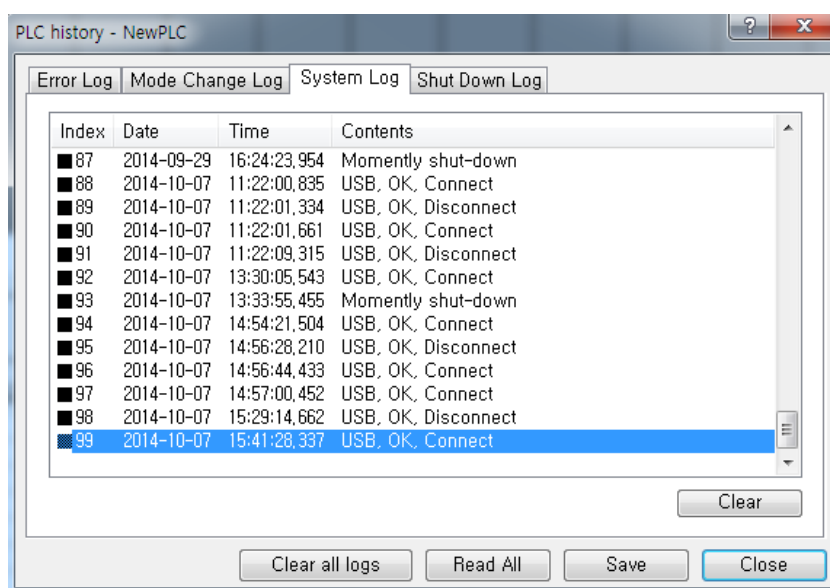

Chapter 2 CPU Function

2.9 How to allocate I/O No.

Allocation of I/O No. is to allocate the address to each module's I/O terminals to read the data from the input modules and output the data in the output modules when executing operation. In the XGB PLC, all modules occupy 64 points.

(1) Allocation of I/O No.

The basic unit occupies 2 slots of No.1 so 124 points are allocated and all remaining expansion module occupies 64 points. (including special, communication modules)

Example of allocating I/O No. based on the system configuration

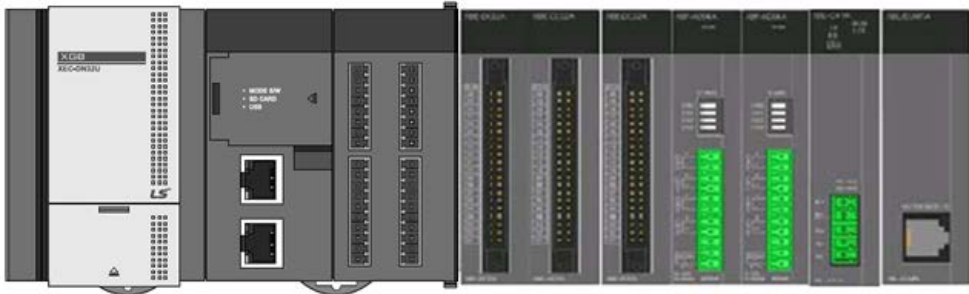

Slot No.	Model	I/O allocation	Remarks
0	XEC-DN32U	input : %IX0.0.0 ~ %IX0.0.63 output : %QX0.0.0 ~ %QX0.0.63	Actual input : %IX0.0.0 ~ %IX0.0.15 Actual output : %QX0.0.0 ~ %QX0.0.15
1	Embedded special functions	input : %IX0.1.0 ~ %IX0.1.63 output : %QX0.1.0 ~ %QX0.1.63	-
2	XBE-DC32A	input : %IX0.2.0 ~ %IX0.2.63 output : %QX0.2.0 ~ %QX0.2.63	Actual input : %IX0.2.0 ~ %IX0.2.31
3	XBE-TN32A	input : %IX0.3.0 ~ %IX0.3.63 output : %QX0.3.0 ~ %QX0.3.63	Actual output : %QX0.3.0 ~ %QX0.3.31
4	XBL-C21A	input : %IX0.4.0 ~ %IX0.4.63 output : %QX0.4.0 ~ %QX0.4.63	-
5	XBF-AD04A	input : %IX0.5.0 ~ %IX0.5.63 output : %QX0.5.0 ~ %QX0.5.63	-
6	XBF-DV04A	input : %IX0.6.0 ~ %IX0.6.63 output : %QX0.6.0 ~ %QX0.6.63	-
7	XBE-DC16A	input : %IX0.7.0 ~ %IX0.7.63 output : %QX0.7.0 ~ %QX0.7.63	Actual input : %IX0.7.0 ~ %IX0.7.15
8	XBE-RY16A	input : %IX0.8.0 ~ %IX0.8.63 output : %QX0.8.0 ~ %QX0.8.63	Actual output : %QX0.8.0 ~ %QX0.8.15

* The number of empty I/O points can be used as the internal relay.

* In the case of the high performance XGB basic type, it does not have the embedded special function corresponding to No.1 slot but occupies No.1 slot as an empty slot.

(2) When the I/O of the I/O parameter is allocated, the allocation information is displayed.

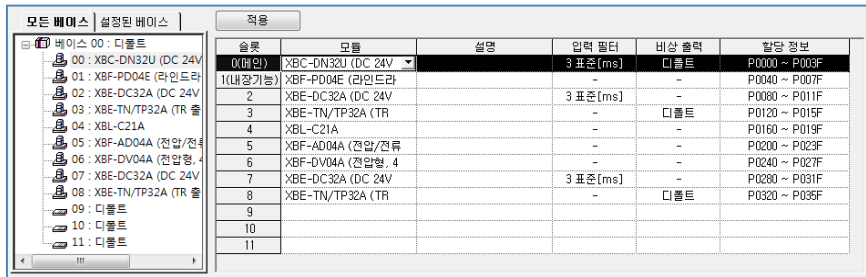

슬롯	모델	설명	입력 필터	비상 출력	합당 정보
0 (기본)	XBC-DN32U (DC 24V)				P0000 ~ P003F
1 (내장기능)	XBF-PD04E (라인드라)				P0040 ~ P007F
2	XBE-DC32A (DC 24V)		3 표준[ms]		P0080 ~ P011F
3	XBE-TN/TP32A (TR)			디플트	P0120 ~ P015F
4	XBL-C21A				P0160 ~ P019F
5	XBF-AD04A (전압/전류)				P0200 ~ P023F
6	XBF-DV04A (전압형, 4)				P0240 ~ P027F
7	XBE-DC32A (DC 24V)		3 표준[ms]		P0280 ~ P031F
8	XBE-TN/TP32A (TR)			디플트	P0320 ~ P035F
9					
10					
11					

2.10 Program Modification during operation (Modification during RUN)

You can modify the programs and communication parameters without stopping control operations during running the PLC. The below describes the basic modification method. For more details on Modification during RUN, refer to the XG5000 manual.

The items that can be modified during RUN are limited to programs, network parameters. You cannot modify adding tasks, deletion, parameters, etc. during RUN.

2.10.1 Modification Procedures during RUN

(1) It shows the currently running program.

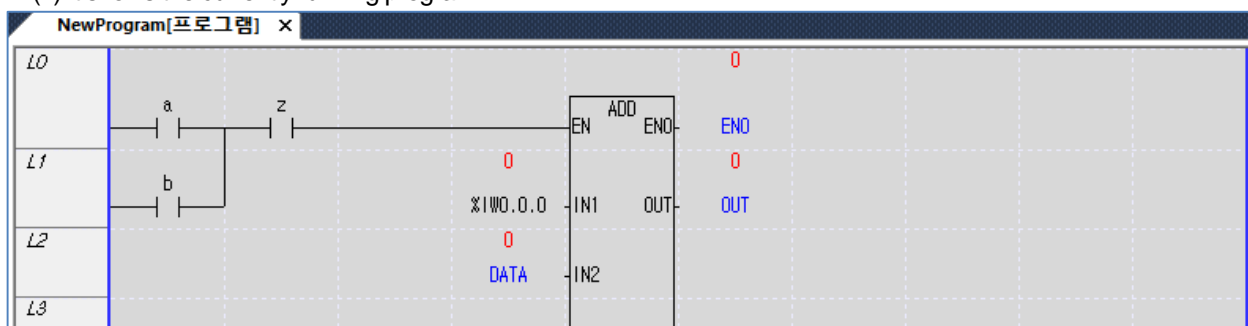

(2) Click 『Online』 - 『Start Modification During RUN』 .

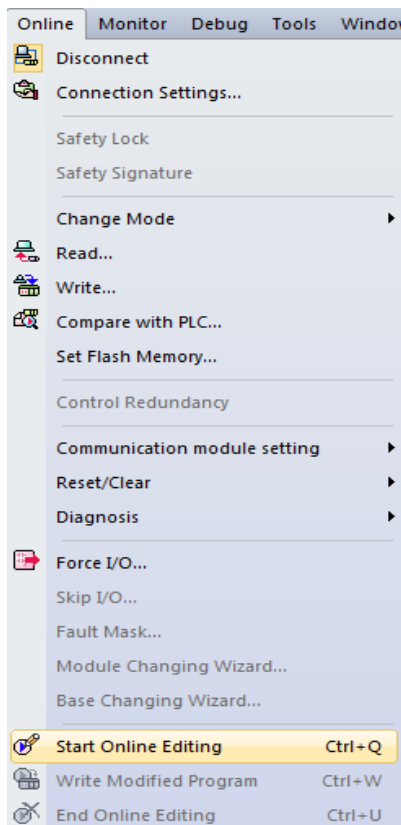

Chapter 2 CPU Function

(3) Then, the background color of the program window changes and it is converted into the mode of modification during RUN.

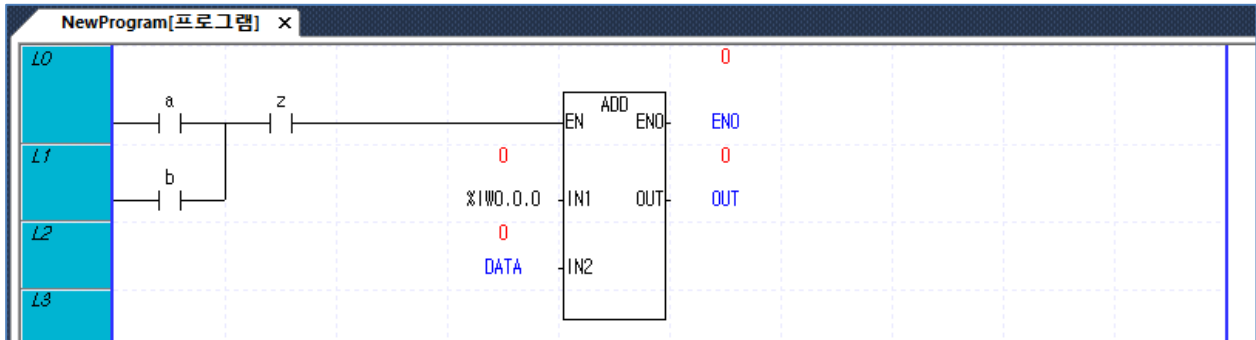

(4) You can modify the program.

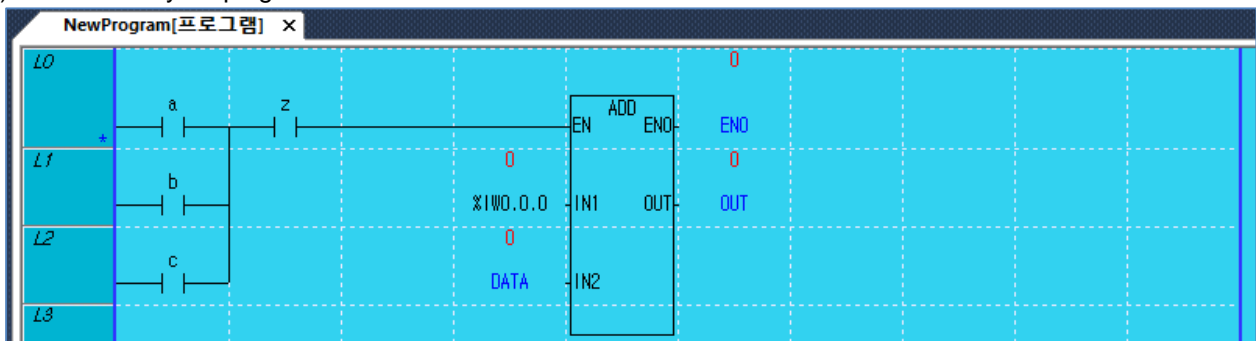

(5) When the modification of the program is completed, click 『Online』 - 『Write Modification During RUN』

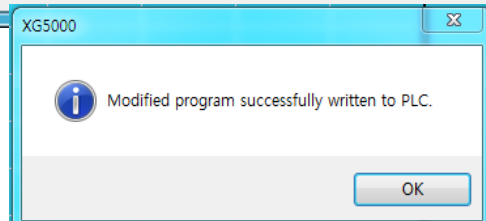
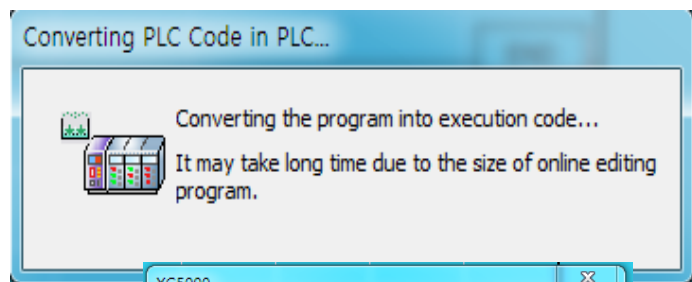
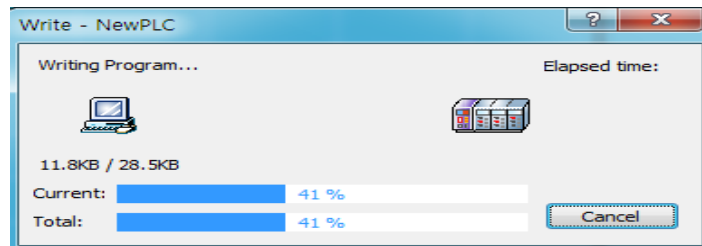
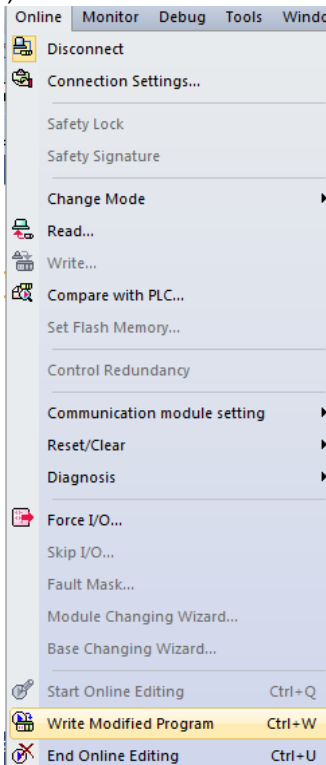

(6) When Write Program is completed, click 『Online』 - 『End Modification During RUN』 .

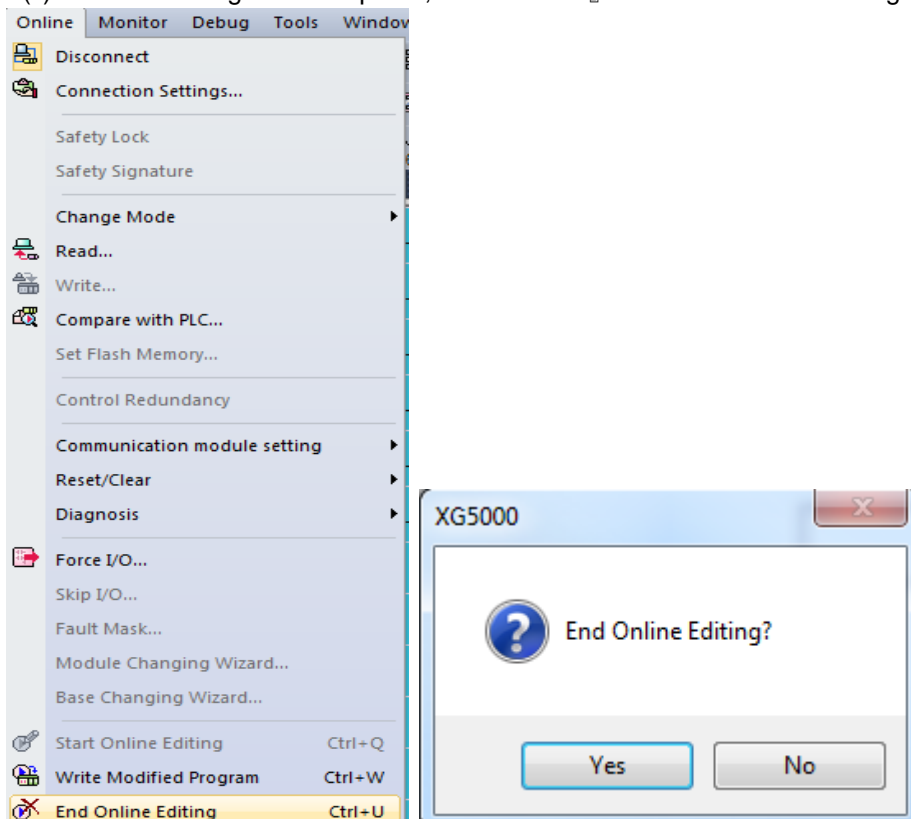

(7) The background color of the program window changes into the original one and modification during RUN is completed.

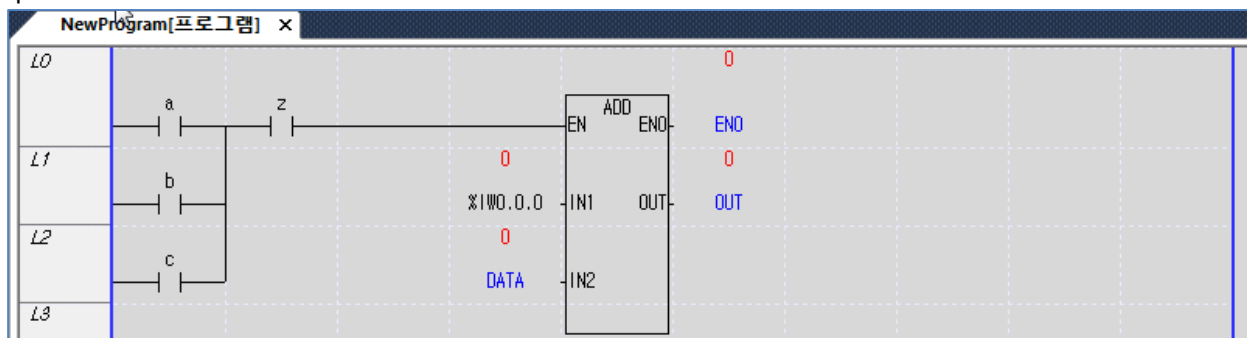

Notice

- For Modification of communication parameters during RUN, after changing the network configuration items of XG5000 in the RUN status without going into the Modification during RUN menu, click 『Online』 - 『Write』 and choose 'Network Parameter' to execute Write.

Chapter 2 CPU Function

2.11 Read I/O information

It is the function to monitor each module's information comprising the XGB PLC system.

(1) If you click 『Online』 - 『I/O Information』, the information of each module of connected systems will be monitored.

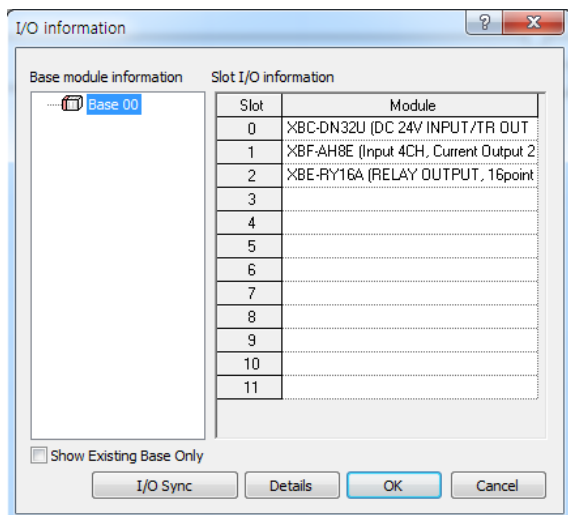

(2) If you click 'Detailed Information' after choosing the module, the details on the module will be displayed.

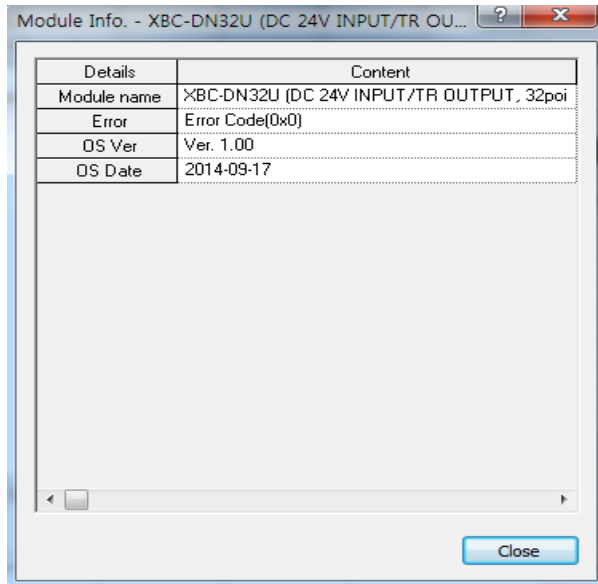

2.12 Monitoring Functions

It is the function to monitor the XGB PLC system's general information.

(1) If you click 『Monitor』, the submenu will be displayed as below.

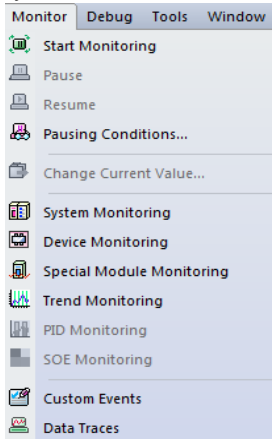

(2) The below table provides the descriptions on each item.

Items	Descriptions	Remarks
Start/End monitor	Specifies the startup and end of the monitor.	Changes every time you click
Suspend monitor	Suspends the monitor.	
Restart monitor	Executes the suspended monitor again.	
Monitor suspension setting	It is the function to suspend the monitor when the set device's value is matched with the conditions.	Restarts when you click 'Restart Monitor'
Changing the current value	Changes the currently selected device's current value.	
System monitor	Monitors the current system's general information.	
Device monitor	It is the function to monitor each device.	
Trend monitor	Monitors the set device's trend.	
User event	Monitors the set device's value when the event specified by a user occurs.	For more details, refer to the XG-5000 manual.
Data trace	Traces the set device's value.	

(a) Changing the current value

It is the function to change the current value of each selected device in the program window.

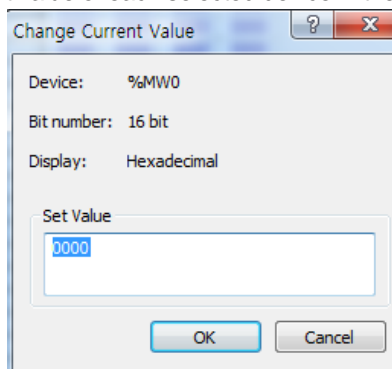

Chapter 2 CPU Function

(b) Device monitor

It is the monitoring function by device.

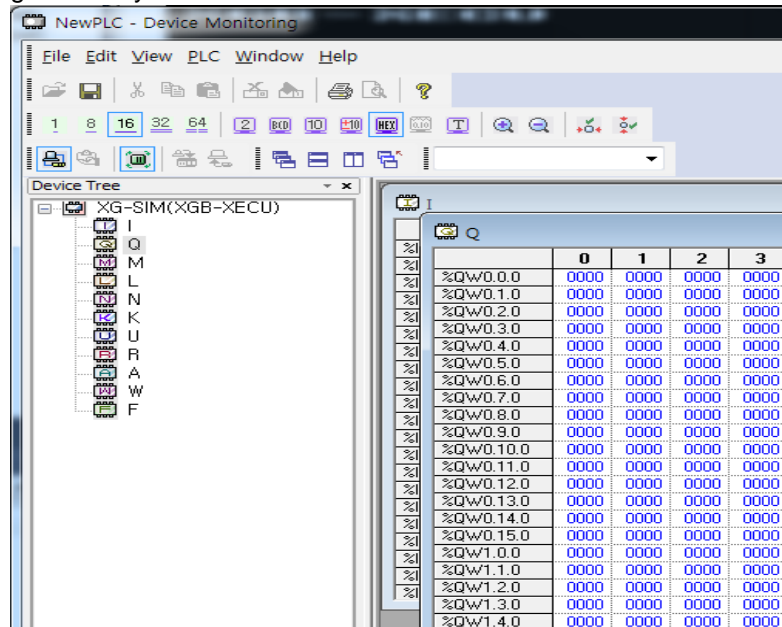

(c) Monitor suspension setting

It is the function to stop monitoring when the set device value is matched.

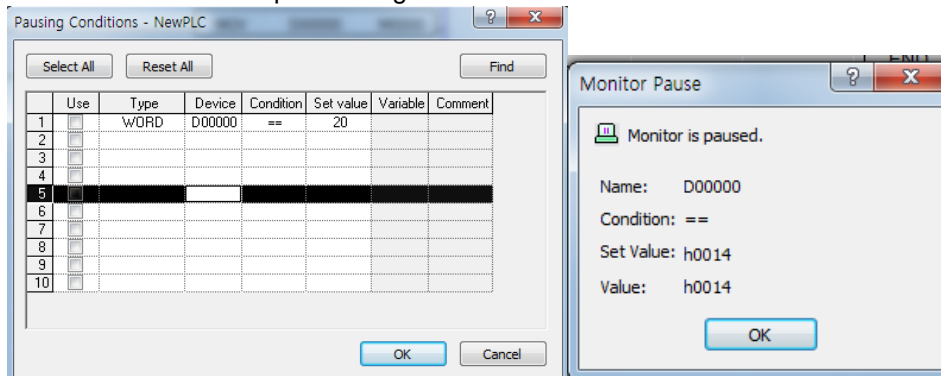

(d) Trend Monitor

It is the function to represent the set device value in a graphic form. The value represented on the graph is not the data collected by the PLC at the right timing but the value read from XG5000 through the communication function. Accordingly, communication delay can occur so it may not be matched with the actual data collected at the right cycle.

You are recommended to use the Trend Monitor function to check the rough data trend.

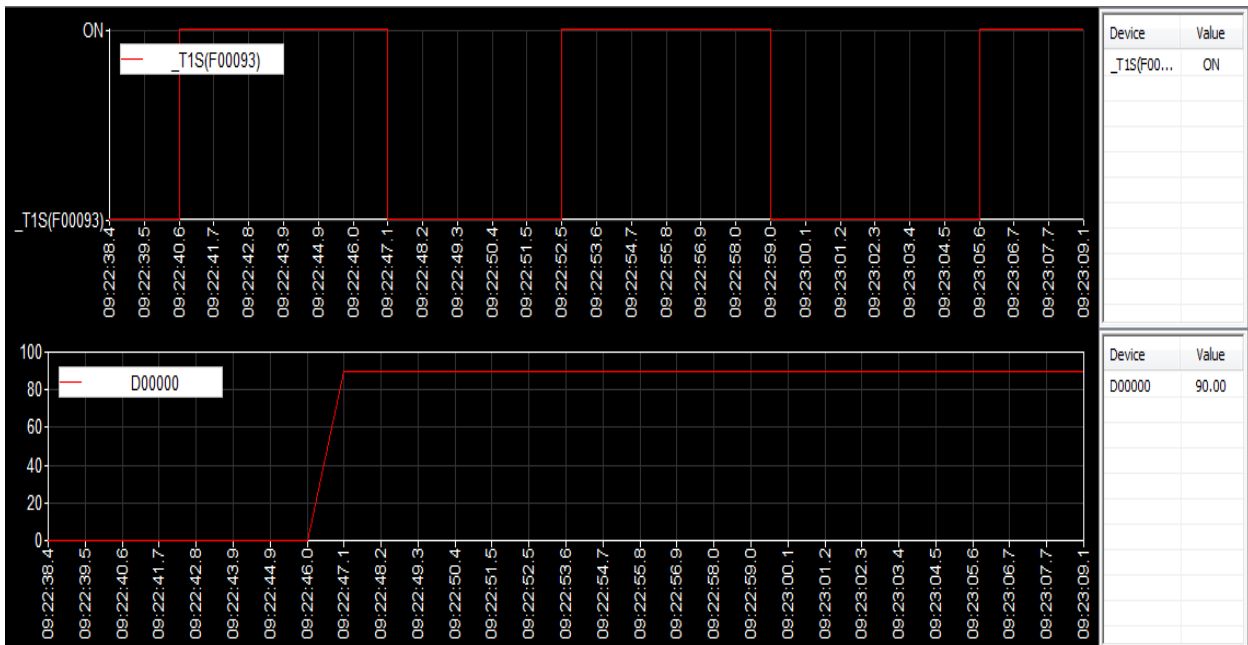

(e) Custom event

- 1) It is the function to monitor the detailed information when the event set by a user occurs. Register the user event additionally.

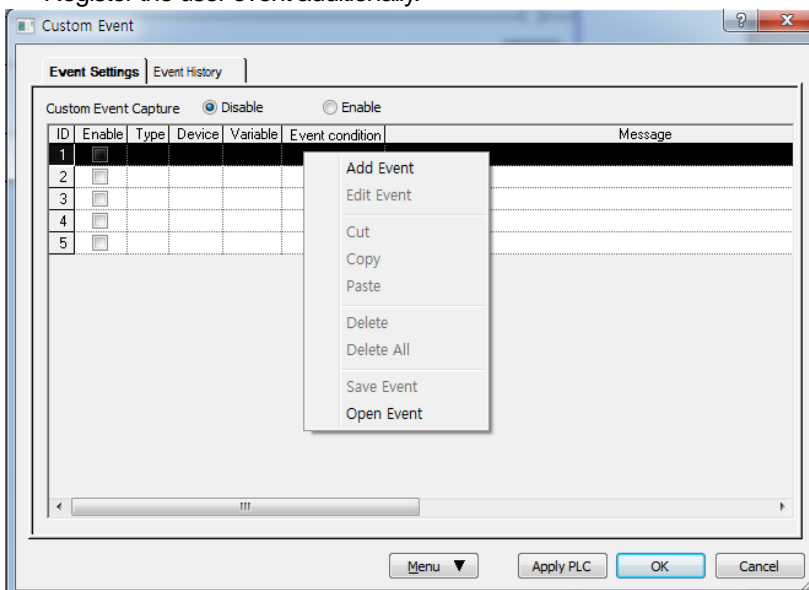

Chapter 2 CPU Function

2) Establish the basic settings and related device.

In case the rising edge of %Mx0 device occur, the Alarm message “Tank 1 Error-> Please Confirm” is recorded with the then values of %MW100 and “DATA”.

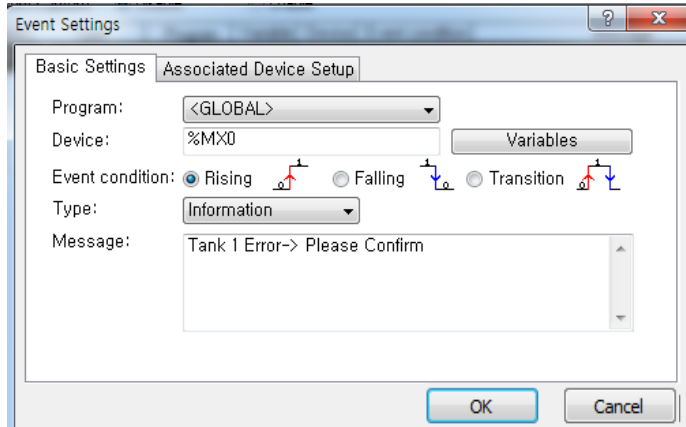

3) Set up the associated device.

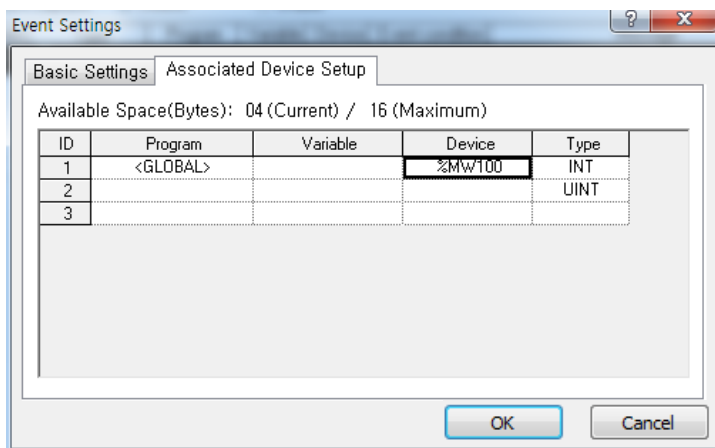

4) It monitors the user event history.

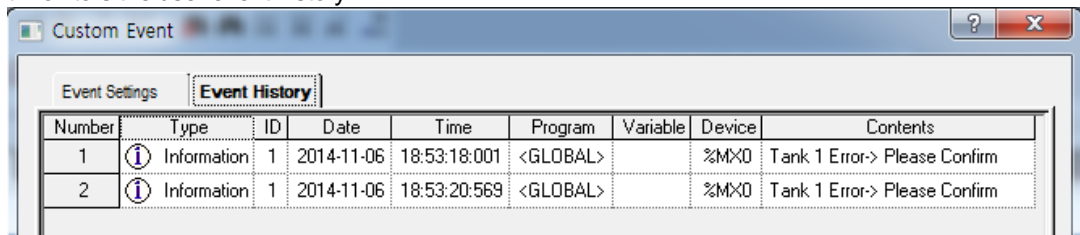

5) If you double-click the occurrence number, the detailed value of the device at the time of occurrence will be monitored with the details as below.

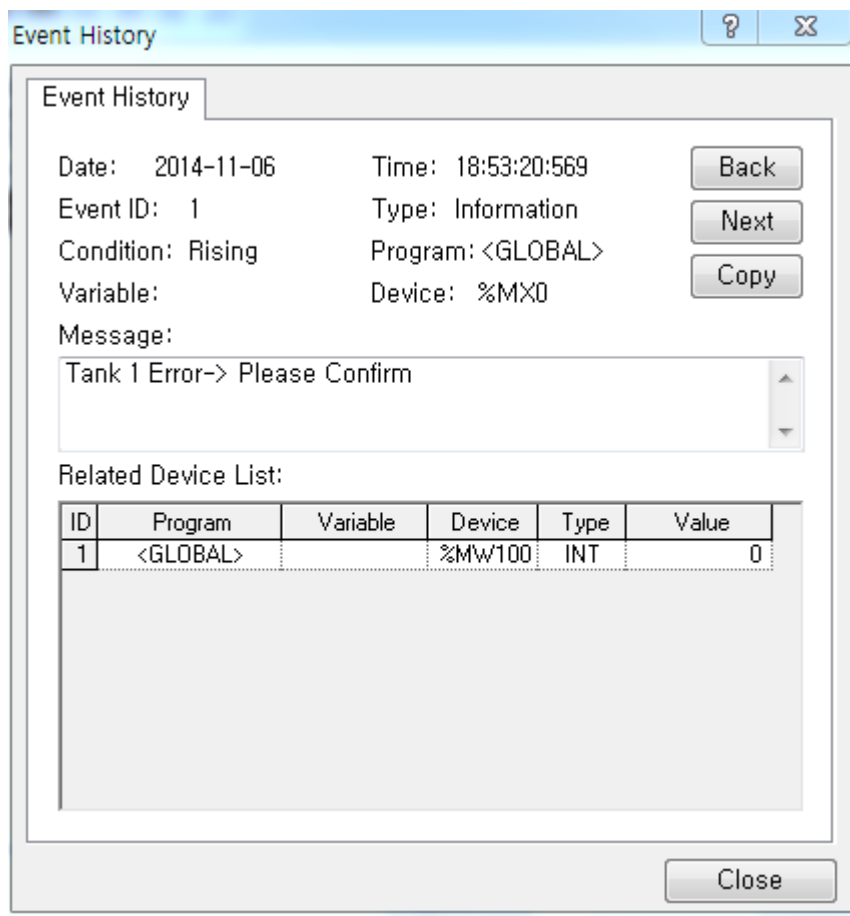
**Notice**

- For more details on the monitor, refer to the XG5000 manual.

Chapter 2 CPU Function

2.13 Function to delete all of the PLC

The function to delete all of PLC is the initialization function to delete all programs, parameters, passwords, data stored in the PLC.

(1) How to delete all of PLC

(a) Click 『Online』 - 『Delete all of PLC 』 .

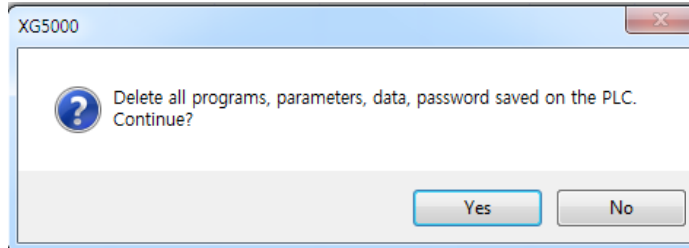

(b) If you choose 『Yes』 in the dialog box, the window for selecting the connection method with the PLC to be deleted is created.

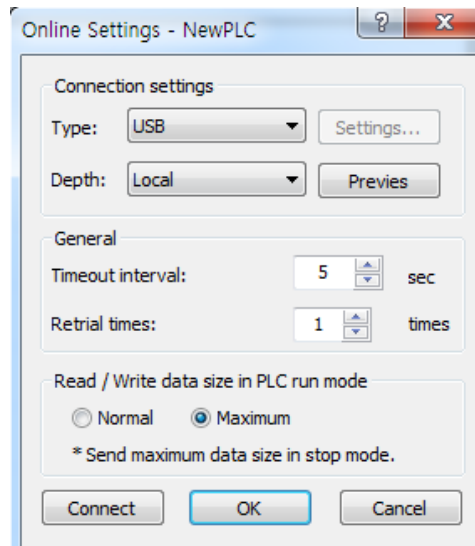

(c) After choosing the connection method with the PLC to be deleted, if you click 『Access』 or 『OK』 , all PLC programs, parameters, data, passwords will be deleted.

Notice

- Although the initial PLC is not connected, the function is executed. You can connect to the PLC after assess setting.
- If you use the function to delete all of PLC, all PLCs' internal data including passwords will be completely deleted so be careful of this.
- If you use the function to delete all of PLC when the password is lost, it is possible to connect to the PLC so you can reuse the PLC.

Chapter 3 Input/Output Specifications

3.1 Introduction

Here describes the notices when selecting digital I/O module used for XGB series.

- (1) For the type of digital input, there are two types such as current sink input and current source input.
- (2) The number of max. Simultaneous input contact point is different according to module type. It depends on the input voltage, ambient temperature. Use input module after checking the specification.
- (3) When response to high speed input is necessary, use interrupt input contact point. Up to 8 interrupt points are supported.
- (4) In case that open/close frequency is high or it is used for conductive load open/close, use Transistor output module or triac output module as the durability of Relay Output Module shall be reduced.
- (5) For output module to run the conductive (L) load, max. open/close frequency should be used by 1second On, 1 second Off.
- (6) For output module, in case that counter timer using DC/DC Converter as a load was used, Inrush current may flow in a certain cycle when it is ON or during operation. In this case, if average current is selected, it may cause the failure. Accordingly, if the previous load was used, it is recommended to connect resistor or inductor to the load in serial in order to reduce the impact of Inrush current or use the large module having a max. load current value.

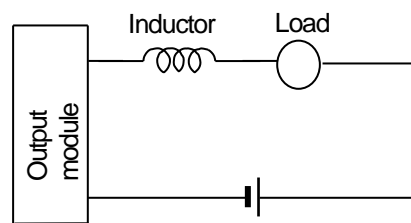
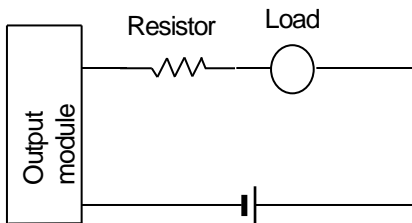

(7) Relay life of Relay output module is shown as below.

Max. life of Relay used in Relay output module is shown as below.

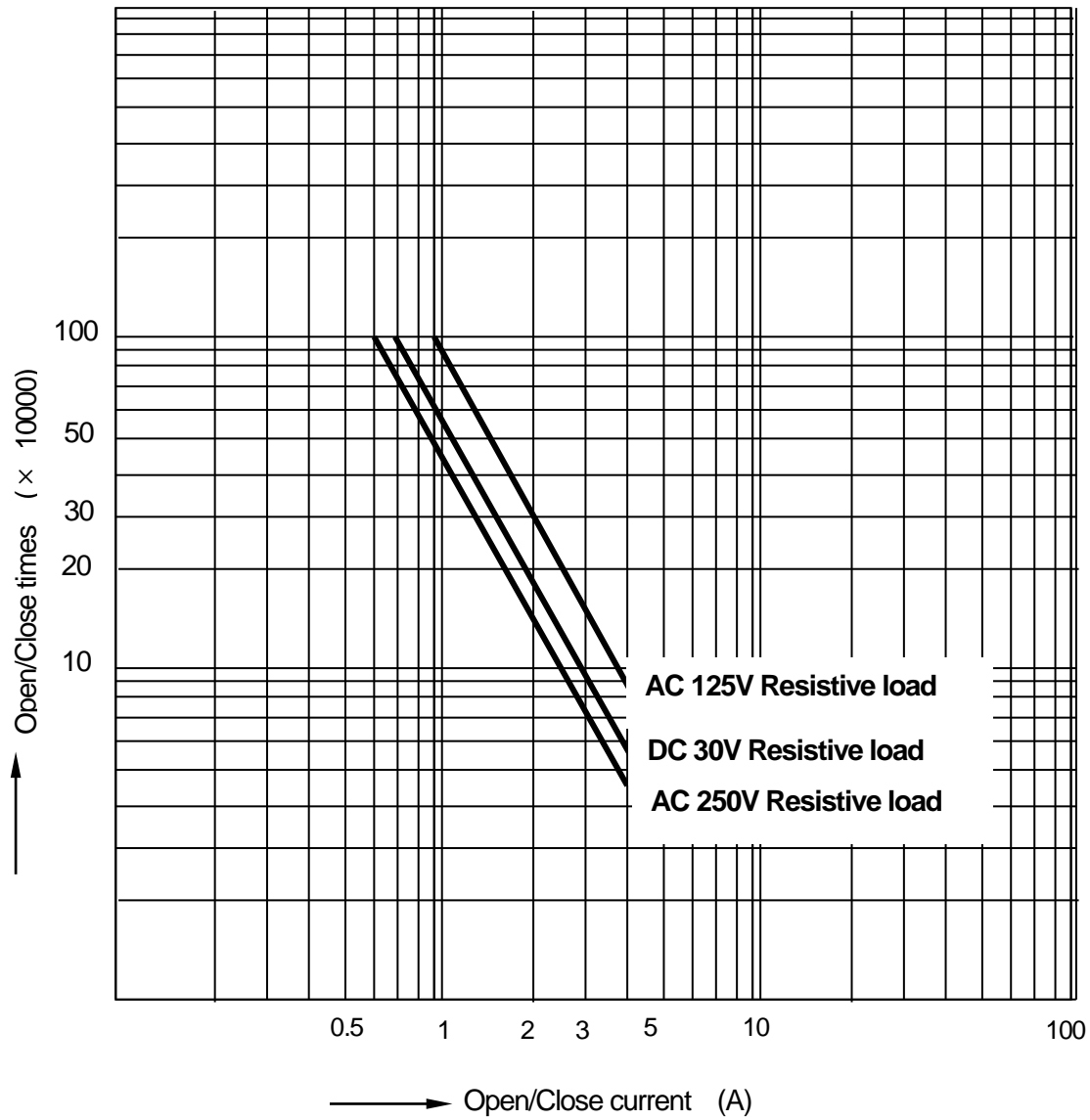

Chapter 3 Input/Output Specification

(8) A clamped terminal with sleeve can not be used for the XGB terminal strip. The clamped terminals suitable for terminal strip are as follows (JOR 1.25-3:Daedong Electricity in Korea).

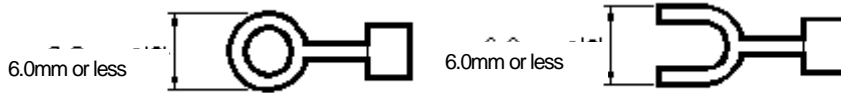

(9) The cable size connected to a terminal strip should be 0.3~0.75 mm² stranded cable and 2.8 mm thick. The cable may have different current allowance depending on the insulation thickness.

(10) The coupling torque available for fixation screw and terminal strip screw should follow the table below.

Coupling position	Coupling torque range
IO module terminal strip screw (M3 screw)	42 ~ 58 N·cm
IO module terminal strip fixation screw (M3 screw)	66 ~ 89 N·cm

(11) Relay life graph is not written based on real use.

(This is not a guaranteed value). So consider margin. Relay life is specified under following condition.

- (a) Rated voltage, load: 3 million times: 100 million times
- (b) 200V AC 1.5A, 240V AC 1A (COS ϕ =0.7): 1 million times
- (c) 200V AC 0.4A, 240V AC 0.3A (COS ϕ =0.7): 3 million times
- (d) 200V AC 1A, 240V AC 0.5A (COS ϕ =0.35): 1 million times
- (e) 200V AC 0.3A, 240V AC 0.15A (COS ϕ =0.35): 3 million times
- (f) 24V DC 1A, 100V DC 0.1A (L/R=7ms): 1million times
- (g) 24V DC 0.3A, 100V DC 0.03A (L/R=7ms): 3million times

(12) Noise can be inserted into input module. To prevent this noise, the user can set filter for input delay in parameter. Consider the environment and set the input filter time.

Input filter time (ms)	Noise signal pulse size (ms)	Reference
1	0.3	
3	1.8	Initial value
5	3	
10	6	
20	12	
70	45	
100	60	

(a) Setting input filter

1) Click 'I/O Parameter' in the project window of XG5000

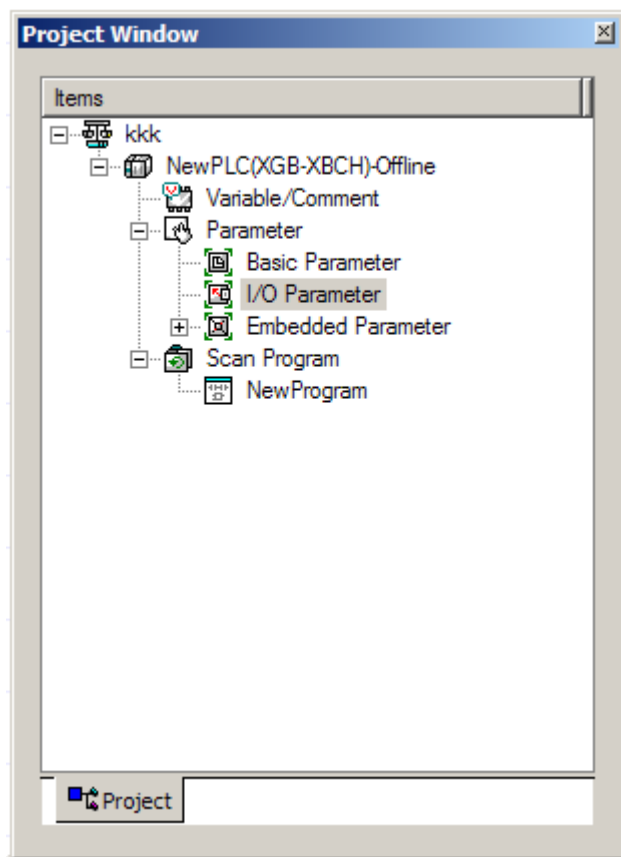

2) Click 'Module' at the slot location.

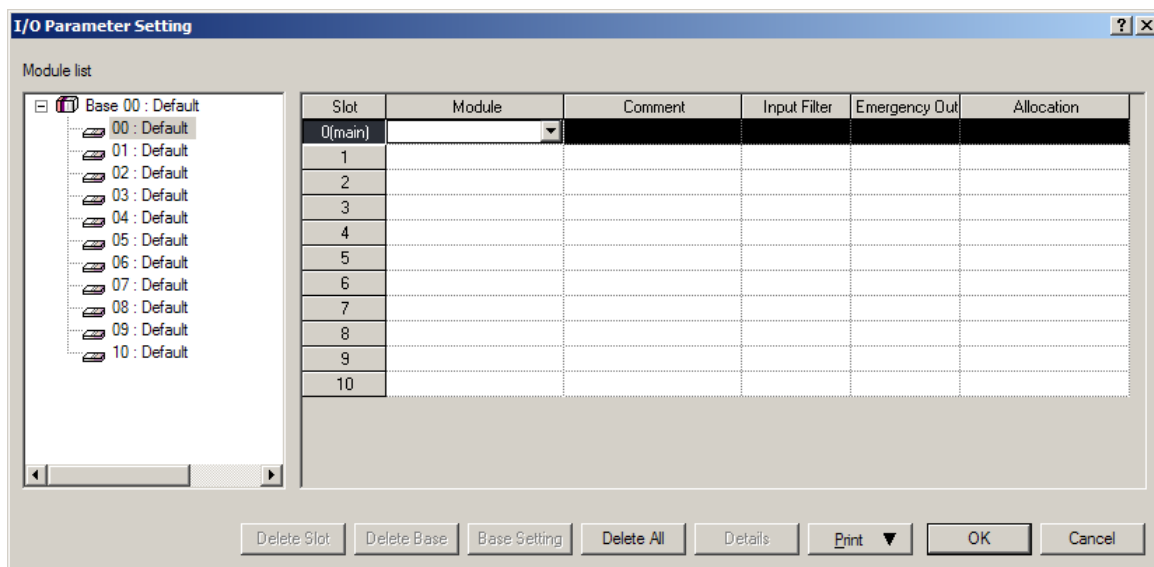

Chapter 3 Input/Output Specification

3) Set I/O module really equipped.

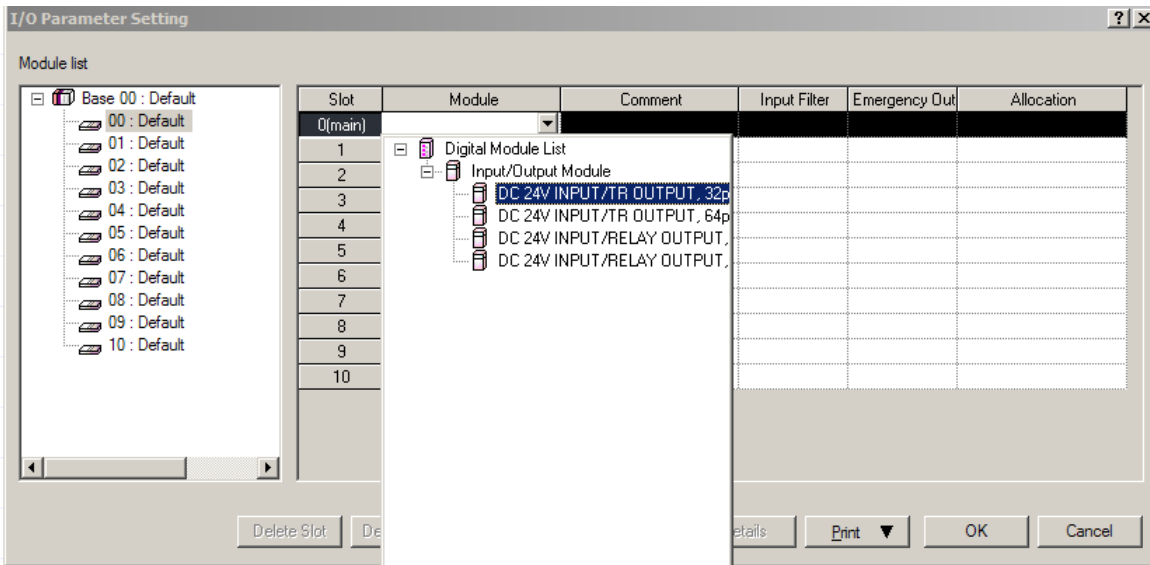

4) After setting I/O module, click Input Filter.

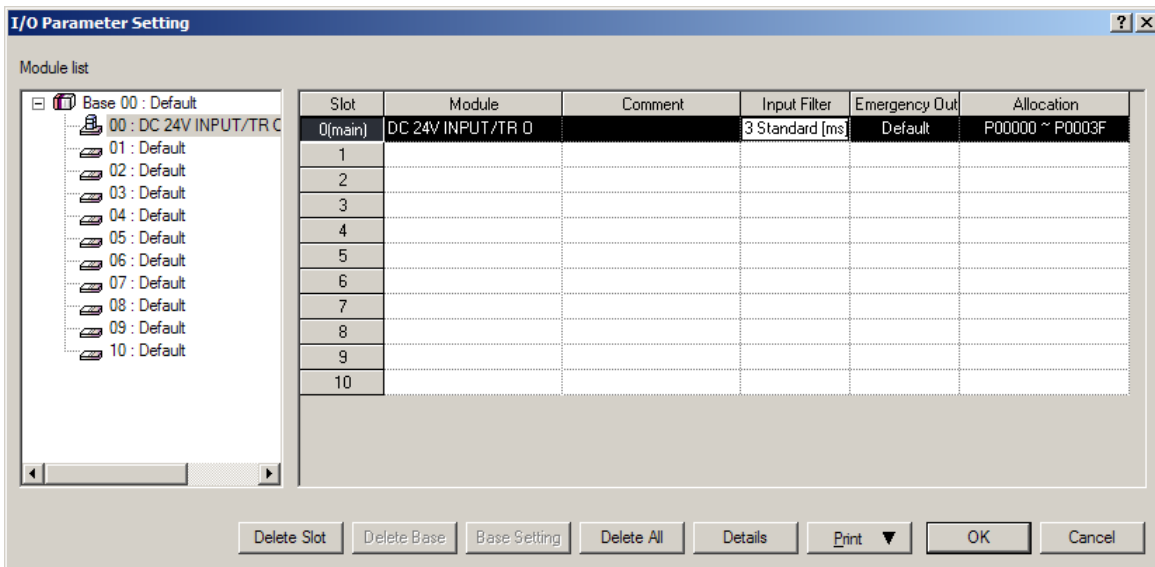

5) Set filter value.

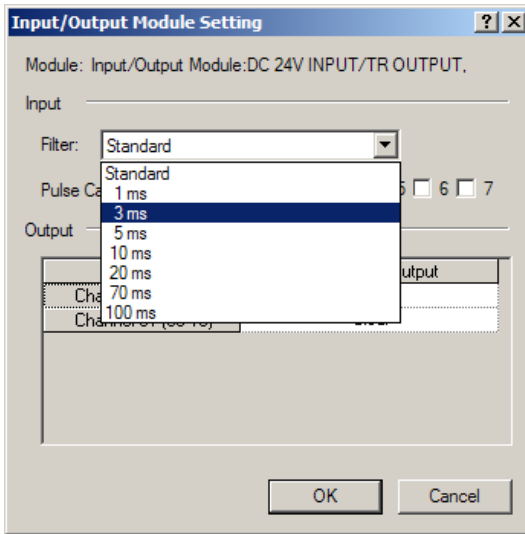

(b) Setting output status in case of error

1) Click Emergency Out in the I/O parameter setting window.

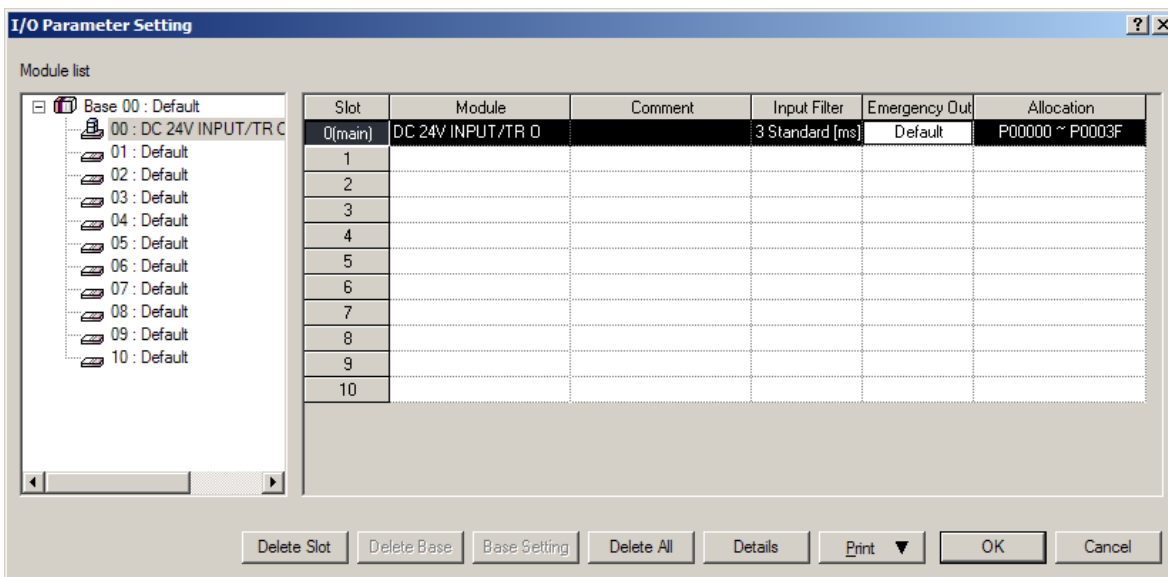

Chapter 3 Input/Output Specification

2) Click Emergency Output.

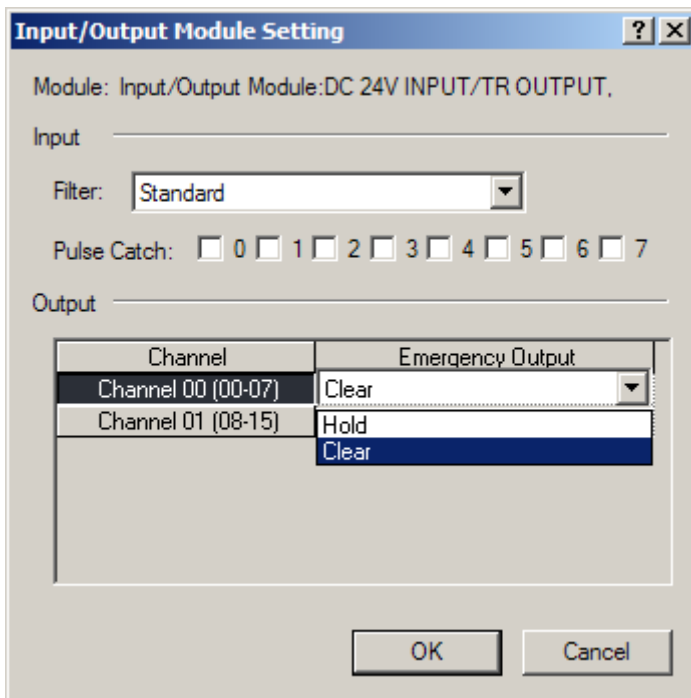

If it is selected as Clear, the output will be Off and if Hold is selected, the output will be kept.

3.2 Main Unit Digital Input Specifications

3.2.1 XEC-DN32U 16 point DC24V input

Model		Main unit				
Specification		XEC-DN32U/(DC)/XEC-DN32UP/(DC)/XEC-DN32UA/(DC) XEC-DR28U/(DC)/XEC-DR28UP/(DC)/XEC-DR28UA/(DC)				
Input point		16 point				
Insulation method		Photo coupler insulation				
Rated input voltage		DC24V				
Rated input current		About 4mA (Contact point 0~3: about 7mA)				
Operation voltage range		DC20.4~28.8V (within ripple rate 5%)				
On voltage / On current		DC19V or higher / 3mA or higher				
Off voltage / Off current		DC6V or lower / 1mA or lower				
Input resistance		About 5.6k Ω (P00~P07: about 4.7k Ω)				
Response time	Off \rightarrow On	1/3/5/10/20/70/100ms (Set by I/O parameter) Default: 3ms				
	On \rightarrow Off					
Insulation pressure		AC560Vrms / 3 cycle (altitude 2000m)				
Insulation resistance		10M Ω or more by MegOhmMeter				
Common method		16 point / COM				
Proper cable size		0.3~0.75mm ²				
Operation indicator		LED On when Input On				
External connection method		8 point terminal block+ 10point terminal connector				
Weight		571g				
Circuit configuration		No.	Contact	No.	Contact	Type
<p>Terminal block no.</p>		TB1	0	TB1	8	
		TB2	1	TB2	9	
		TB3	2	TB3	A	
		TB4	3	TB4	B	
		TB5	4	TB5	C	
		TB6	5	TB6	D	
		TB7	6	TB7	E	
		TB8	7	TB8	F	
				TB9	COM	
				TB10	COM	

Chapter 3 Input/Output Specification

3.3 Main Unit Digital Output Specifications

3.3.1 XEC-DN32U 16 point transistor output (Sink type)

Specification	Model	Main unit		
		XEC-DN32U/(DC)	XEC-DN32UP/(DC)	XEC-DN32UA/(DC)
Output point	16 point			
Insulation method	Photo coupler insulation			
Rated load voltage	DC 12/24V			
Operation load voltage range	DC 10.2 ~ 26.4V			
Max. load current	0.5A / 1 point, 2A / 1COM			
Off leakage current	0.1mA or less			
Max. inrush current	4A / 10ms or less			
Max. voltage drop when On	DC 0.4V or less			
Surge absorber	Zener diode			
Response time	Off → On	1ms or less		
	On → Off	1ms or less (rated load, resistive load)		
Common method	16 point / COM			
Proper wire size	Stranded wire 0.3~0.75mm ² (external diameter 2.8mm or less)			
External power	Voltage	DC12/24V ± 10% (Ripple voltage 4 Vp-p or less)		
	Current	10mA or less (When connecting DC24V)		
Operation indicator	LED On when Output On			
External connection method	8 point terminal block connector+ 10 point terminal block connector			
Weight	571g	683g(UP)	683g(UA)	
Circuit configuration				
		No.	Contact	Type
		TB01	0	
TB02	1	TB01		
TB03	2	TB02		
TB04	3	TB03		
TB05	4	TB04		
TB06	5	TB05		
TB07	6	TB06		
TB08	7	TB07		
TB01	8	TB08		
TB02	9	TB09		
TB03	A	TB10		
TB04	B	TB11		
TB05	C	TB12		
TB06	D	TB13		
TB07	E	TB14		
TB08	F	TB15		
TB09	DC12/24V	TB16		
TB10	COM	TB17		
		TB18		

3.3.2 XEC-DP32U 16 point transistor output (Source type)

Specification	Model	Main unit				
		XEC-DP32U/(DC)	XEC-DP32UP/(DC)	XEC-DP32UA/(DC)		
Output point		16 point				
Insulation method		Photo coupler insulation				
Rated load voltage		DC 12/24V				
Operation load voltage range		DC 10.2 ~ 26.4V				
Max. load current		0.5A / 1 point, 2A / 1COM				
Off leakage current		0.1mA or less				
Max. inrush current		4A / 10ms or less				
Max. voltage drop when On		DC 0.4V or less				
Surge absorber		Zener diode				
Response time	Off → On	1ms or less				
	On → Off	1ms or less (rated load, resistive load)				
Common method		16 point / COM				
Proper wire size		Stranded wire 0.3~0.75mm ² (external diameter 2.8mm or less)				
External power	Voltage	DC12/24V ± 10% (Ripple voltage 4 Vp-p or less)				
	Current	10mA or less (When connecting DC24V)				
Operation indicator		LED On when Output On				
External connection method		8 point terminal block connector+ 10 point terminal block connector				
Weight		571g	683g(UP)	683g(UA)		
Circuit configuration				No.	Contact	Type
				TB01	0	
				TB02	1	
				TB03	2	
				TB04	3	
				TB05	4	
				TB06	5	
				TB07	6	
				TB08	7	
				TB09	8	
				TB10	9	
				TB11	A	
				TB12	B	
				TB13	C	
				TB14	D	
				TB15	E	
				TB16	F	
				TB17	COM	
				TB18	0V	

Chapter 3 Input/Output Specification

3.3.3 XEC-DR28U 12 point relay output

Specification		Model	Main unit				
		XEC-DR28U(DC)	XEC-DR28UA(DC)	XEC-DR28UP(DC)			
Output point		16 point					
Insulation method		Relay insulation					
Rated load voltage/current		DC24V 2A (Resistive load) / AC220V 2A (COS Φ = 1), 2A/COM(P20~23),5A/COM(P24~2B)					
Min. load voltage/current		DC5V / 1mA					
Max. load voltage		AC250V, DC125V					
Off leakage current		0.1mA (AC220V, 60Hz)					
Max. On/Off frequency		3,600 times/hr					
Surge absorber		none					
Service life	Mechanical	20 millions times or more					
	Electrical	Rated load voltage / current 100,000 times or more					
		AC200V / 1.5A, AC240V / 1A (COS Φ = 0.7) 100,000 times or more					
		AC200V / 1A, AC240V / 0.5A (COS Φ = 0.35) 100,000 times or more					
		DC24V / 1A, DC100V / 0.1A (L / R = 7ms) 100,000 times or more					
Response time	Off \rightarrow On	10ms or less					
	On \rightarrow Off	12ms or less					
Common method		1point/COM(P20~23) , 4point/COM(P24~2B)					
Proper cable size		Stranded cable 0.3~0.75 mm ² (External diameter 2.8 mm or less)					
Current consumption		Output On, LED On					
External connection method		8 point terminal block connector +10 point terminal block connector 8					
Circuit configuration					No.	Contact	Type
					TB01	0	
					TB02	COM0	
					TB03	1	
					TB04	COM1	
					TB05	2	
					TB06	COM2	
					TB07	3	
					TB08	COM3	
					TB09	4	
					TB10	5	
					TB11	6	
					TB12	7	
					TB13	COM4	
					TB14	8	
					TB15	9	
					TB16	A	
					TB17	B	
					TB18	COM5	



3.4 Digital Input Specifications

3.4.1 8 point DC24V input module (Source/Sink type)

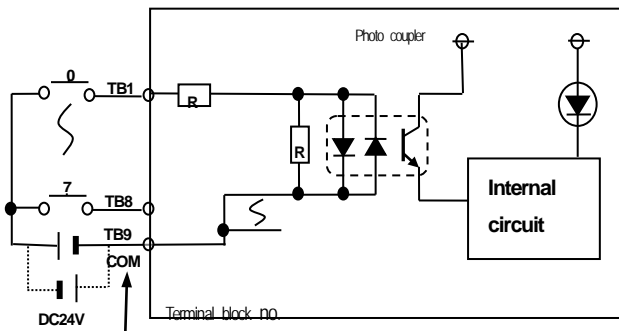

Model		DC input module		
		XBE-DC08A		
Specification				
Input point		8 point		
Insulation method		Photo coupler insulation		
Rated input voltage		DC24V		
Rated input current		About 4mA		
Operation voltage range		DC20.4~28.8V (ripple rate < 5%)		
On Voltage/Current		DC19V or higher / 3 mA or higher		
Off Voltage/Current		DC6V or less / 1mA or less		
Input resistance		About 5.6kΩ		
Response time	Off → On	1/3/5/10/20/70/100ms (set by CPU parameter) Default: 3ms		
	On → Off			
Insulation pressure		AC560Vrms / 3Cycle (altitude 2000m)		
Insulation resistance		10MΩ or more by Megohmmeter		
Common method		8 point / COM		
Proper cable size		Stranded pair 0.3~0.75mm ² (External diameter 2.8mm or less)		
Current consumption		30mA (when all point On)		
Operation indicator		Input On, LED On		
External connection method		10 point terminal block connector		
Weight		52 g		
Circuit configuration		No.	Contact	Type
		TB1	0	
		TB2	1	
		TB3	2	
		TB4	3	
		TB5	4	
		TB6	5	
		TB7	6	
		TB8	7	
		TB9	COM	
		TB10	COM	

Chapter 3 Input/Output Specification

3.4.2 16 point DC24V input module (Sink/Source type)

Specification	Model	DC input module		
		XBE-DC16A	XBE-DC16B	
Input point	16 point			
Insulation method	Photo coupler insulation			
Rated input voltage	DC24V	DC12/24V		
Rated input current	About 4mA	About 4/8mA		
Operation voltage range	DC20.4~28.8V (ripple rate < 5%)	DC9.5~30V (ripple rate < 5%)		
On Voltage/Current	DC19V or higher / 3 mA or higher	DC9V or higher / 3 mA or higher		
Off Voltage/Current	DC6V or less / 1mA or less	DC5V or less / 1mA or less		
Input resistance	About 5.6k Ω	About 2.7k Ω		
Response time	Off \rightarrow On	1/3/5/10/20/70/100ms (set by CPU parameter) Default: 3ms		
	On \rightarrow Off			
Insulation pressure	AC560Vrms / 3Cycle (altitude 2000m)			
Insulation resistance	10M Ω or more by Megohmmeter			
Common method	16 point / COM			
Proper cable size	Stranded cable 0.3~0.75mm ² (External diameter 2.8mm or less)			
Current consumption	40mA (when all point On)			
Operation indicator	Input On, LED On			
External connection method	8 pin terminal block connector + 10 pin terminal block connector			
Weight	53 g			
Circuit configuration				
		No.	Contact	Type
		TB1	0	
TB2	1			
TB3	2			
TB4	3			
TB5	4			
TB6	5			
TB7	6			
TB8	7			
TB1	8			
TB2	9			
TB3	A			
TB4	B			
TB5	C			
TB6	D			
TB7	E			
TB8	F			
TB9	COM			
TB10	COM			

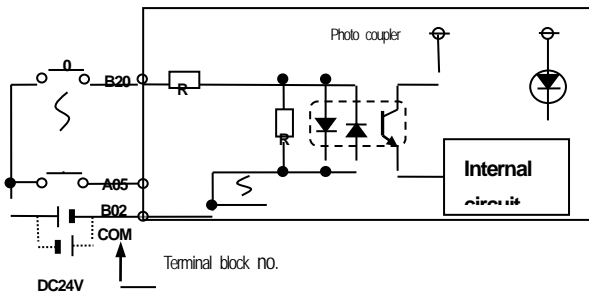
3.4.3 32 point DC24V input module (Source/Sink type)

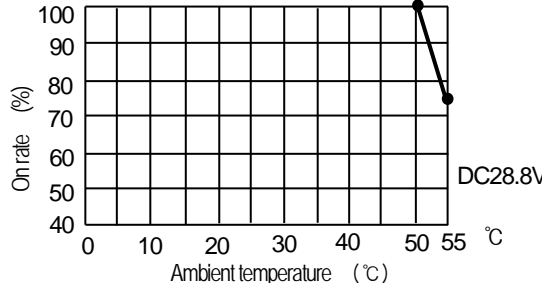
Specification	Model	DC input module				
		XBE-DC32A				
Input point	32 point					
Insulation method	Photo coupler insulation					
Rated input voltage	DC24V					
Rated input current	About 4mA					
Operation voltage range	DC20.4~28.8V (ripple rate < 5%)					
Input Derating	Refer to Derating diagram					
On Voltage/Current	DC 19V or higher / 3 mA or higher					
Off Voltage/Current	DC 6V or less / 1 mA or less					
Input resistance	About 5.6kΩ					
Response time	Off → On	1/3/5/10/20/70/100ms (set by CPU parameter) Default:3ms				
	On → Off					
Insulation pressure	AC 560Vrms / 3 Cycle (altitude 2000m)					
Insulation resistance	10MΩ or more by Megohmmeter					
Common method	32 point / COM					
Proper cable size	0.3mm ²					
Current consumption	50mA (when all point On)					
Operation indicator	Input On, LED On					
External connection method	40 pin connector					
Weight	60g					
Circuit configuration		No.	Contact	No.	Contact	Type
		B20	00	A20	10	
		B19	01	A19	11	
B18	02	A18	12			
B17	03	A17	13			
B16	04	A16	14			
B15	05	A15	15			
B14	06	A14	16			
B13	07	A13	17			
B12	08	A12	18			
B11	09	A11	19			
B10	0A	A10	1A			
B09	0B	A09	1B			
B08	0C	A08	1C			
B07	0D	A07	1D			
B06	0E	A06	1E			
B05	0F	A05	1F			
B04	NC	A04	NC			
B03	NC	A03	NC			
B02	COM	A02	COM			
B01	COM	A01	COM			
<p>Input Derating diagram</p> 						

Chapter 3 Input/Output Specification

3.5 Digital Output Specifications

3.5.1 8 point relay output module

Model Specification		Relay output module				
		XBE-RY08A				
Output point		8 point				
Insulation method		Relay insulation				
Rated load voltage / Current		DC24V 2A (Resistive load) / AC220V 2A (COS Ψ = 1), 5A/COM				
Min. load voltage/Current		DC5V / 1mA				
Max. load voltage/Current		AC250V, DC125V				
Off leakage current		0.1mA (AC220V, 60Hz)				
Max. On/Off frequency		3,600 times/hr				
Surge absorber		None				
Service life	Mechanical	20 millions times or more				
	Electrical	Rated load voltage / current 100,000 times or more				
		AC200V / 1.5A, AC240V / 1A (COS Ψ = 0.7) 100,000 times or more				
		AC200V / 1A, AC240V / 0.5A (COS Ψ = 0.35) 100,000 times or more				
		DC24V / 1A, DC100V / 0.1A (L / R = 7ms) 100,000 times or more				
Response time	Off \rightarrow On	10ms or less				
	On \rightarrow Off	12ms or less				
Common method		8 point / COM				
Proper cable size		Stranded cable 0.3~0.75mm ² (External diameter 2.8mm or less)				
Current consumption		230mA (when all point On)				
Operation indicator		Output On, LED On				
External connection method		9 point terminal block connector				
Weight		80g				
Circuit configuration				No.	Contact	Type
				TB1	0	
				TB2	1	
				TB3	2	
				TB4	3	
				TB5	4	
				TB6	5	
				TB7	6	
				TB8	7	
				TB9	COM	

3.5.2 8 point relay output module (Independent point)

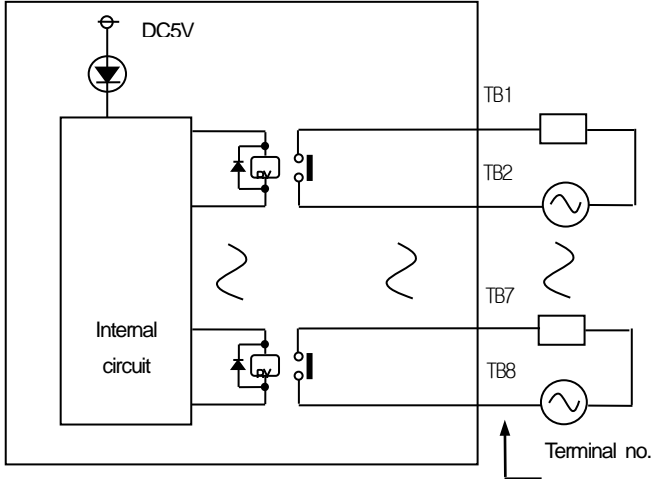
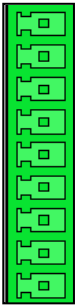
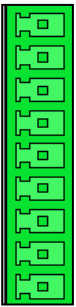
Model Specification		Relay output module		
		XBE-RY08B		
Output point		8 point		
Insulation method		Relay insulation		
Rated load voltage / Current		DC24V 2A (Resistive load) / AC220V 2A (COSΨ = 1), 2A/COM		
Min. load voltage/Current		DC5V / 1mA		
Max. load voltage/Current		AC250V, DC125V		
Off leakage current		0.1mA (AC220V, 60Hz)		
Max. On/Off frequency		3,600 times/hr		
Surge absorber		None		
Service life	Mechanical	20 millions times or more		
	Electrical	Rated load voltage / current 100,000 times or more		
		AC200V / 1.5A, AC240V / 1A (COSΨ = 0.7) 100,000 times or more		
		AC200V / 1A, AC240V / 0.5A (COSΨ = 0.35) 100,000 times or more		
		DC24V / 1A, DC100V / 0.1A (L / R = 7ms) 100,000 times or more		
Response time	Off → On	10ms or less		
	On → Off	12ms or less		
Common method		1 point / COM		
Proper cable size		Stranded cable 0.3~0.75mm ² (External diameter 2.8mm or less)		
Current consumption		230mA (when all point On)		
Operation indicator		Output On, LED On		
External connection method		9 point terminal block connector x 2		
Weight		81g		
Circuit configuration				
		No.	Contact	No.
		TB1	0	
		TB2	COM0	
		TB3	1	
		TB4	COM1	
		TB5	2	
		TB6	COM2	
		TB7	3	
		TB8	COM3	
		TB9	NC	
		TB1	4	
		TB2	COM4	
		TB3	5	
		TB4	COM5	
		TB5	6	
		TB6	COM6	
		TB7	7	
		TB8	COM7	
TB9	NC			

Chapter 3 Input/Output Specification

3.5.3 16 point relay output module

Specification		Model	Relay output module					
			XBE-RY16A					
Output point		16 point						
Insulation method		Relay insulation						
Rated load voltage/ current		DC24V 2A (Resistive load) / AC220V 2A (COS Ψ = 1), 5A/COM						
Min. load voltage/current		DC5V / 1mA						
Max. load voltage/current		AC250V, DC125V						
Off leakage current		0.1mA (AC220V, 60Hz)						
Max. On/Off frequency		3,600 times/hr						
Surge absorber		None						
Service life	Mechanical	20 millions times or more						
	Electrical	Rated load voltage / current 100,000 times or more						
		AC200V / 1.5A, AC240V / 1A (COS Ψ = 0.7) 100,000 times or more						
		AC200V / 1A, AC240V / 0.5A (COS Ψ = 0.35) 100,000 times or more						
		DC24V / 1A, DC100V / 0.1A (L / R = 7ms) 100,000 times or more						
Response time	Off \rightarrow On	10ms or less						
	On \rightarrow Off	12ms or less						
Common method		8 point / COM						
Proper cable size		Stranded cable 0.3~0.75mm ² (External diameter 2.8mm or less)						
Current consumption		420mA (when all point On)						
Operation indicator		Output On, LED On						
External connection method		9 point terminal block connector x 2 ea						
Weight		130g						
Circuit configuration					No.	Contact	Type	
					TB1	0		
					TB2	1		TB1
					TB3	2		TB2
					TB4	3		TB3
					TB5	4		TB4
					TB6	5		TB5
					TB7	6		TB6
					TB8	7		TB7
					TB9	COM		TB8
					TB1	8	TB9	
					TB2	9	TB1	
					TB3	A	TB2	
					TB4	B	TB3	
					TB5	C	TB4	
					TB6	D	TB5	
					TB7	E	TB6	
					TB8	F	TB7	
					TB9	COM	TB8	

3.5.4 8 point transistor output module (Sink type)

Specification		Model	Transistor output module				
			XBE-TN08A				
Output point		8 point					
Insulation method		Photo coupler insulation					
Rated load voltage		DC 12 / 24V					
Load voltage range		DC 10.2 ~ 26.4V					
Max. load voltage		0.5A / 1 point					
Off leakage current		0.1mA or less					
Max. inrush current		4A / 10ms or less					
Max. voltage drop (On)		DC 0.4V or less					
Surge absorber		Zener Diode					
Response time	Off → On	1ms or less					
	On → Off	1ms or less (Rated load, resistive load)					
Common method		8 point / COM					
Proper cable size		Stranded cable 0.3~0.75mm ² (External diameter 2.8mm or less)					
Current consumption		40mA (when all point On)					
External power supply	Voltage	DC12/24V ± 10% (ripple voltage 4 Vp-p or less)					
	Current	10mA or less (DC24V connection)					
Operation indicator		Output On, LED On					
External connection method		10 point terminal block connector					
Weight		52g					
Circuit configuration					No.	Contact	Type
					TB01	0	
					TB02	1	
					TB03	2	
					TB04	3	
					TB05	4	
					TB06	5	
					TB07	6	
					TB08	7	
					TB09	DC12 / 24V	
					TB10	COM	

Chapter 3 Input/Output Specification

3.5.5 16 point transistor output module (Sink type)

Specification		Model		
		Transistor output module XBE-TN16A		
Output point		16 point		
Insulation method		Photo coupler insulation		
Rated load voltage		DC 12 / 24V		
Load voltage range		DC 10.2 ~ 26.4V		
Max. load voltage		0.5A / 1 point, 2A / 1COM		
Off leakage current		0.1mA or less		
Max. inrush current		4A / 10ms or less		
Max. voltage drop (On)		DC 0.4V or less		
Surge absorber		Zener Diode		
Response time	Off → On	1ms or less		
	On → Off	1ms or less (Rated load, resistive load)		
Common method		16 point / COM		
Proper cable size		Stranded cable 0.3~0.75mm ² (External diameter 2.8mm or less)		
Current consumption		60mA (when all point On)		
External power supply	Voltage	DC12/24V ± 10% (ripple voltage 4 Vp-p or less)		
	Current	10mA or less (DC24V connection)		
Operation indicator		Output On, LED On		
External connection method		8 pin terminal block connector + 10 pin terminal block connector		
Weight		54 g		
Circuit configuration				
		No.	Contact	Type
		TB01	0	
		TB02	1	
		TB03	2	
		TB04	3	
		TB05	4	
		TB06	5	
		TB07	6	
		TB08	7	
		TB01	8	
		TB02	9	
		TB03	A	
		TB04	B	
		TB05	C	
		TB06	D	
		TB07	E	
TB08	F			
TB09	DC12 / 24V			
TB10	COM			

3.5.6 32 point transistor output module (Sink type)

Specification		Model	Transistor output module						
			XBE-TN32A						
Output point		32 point							
Insulation method		Photo coupler insulation							
Rated load voltage		DC 12 / 24V							
Load voltage range		DC 10.2 ~ 26.4V							
Max. load voltage		0.2A / 1 point, 2A / 1COM							
Off leakage current		0.1mA or less							
Max. inrush current		0.7A / 10ms or less							
Max. voltage drop (On)		DC 0.4V or less							
Surge absorber		Zener Diode							
Response time	Off → On	1ms or less							
	On → Off	1ms or less (Rated load, resistive load)							
Common method		32 point / COM							
Proper cable size		0.3mm ²							
Current consumption		120mA (when all point On)							
External power supply	Voltage	DC12/24V ± 10% (ripple voltage 4 Vp-p or less)							
	Current	20mA or less (DC24V connection)							
Operation indicator		Output On, LED On							
External connection method		40 pin connector							
Weight		60g							
Circuit configuration					No.	Contact	No.	Contact	Type
					B20	00	A20	10	
					B19	01	A19	11	
					B18	02	A18	12	
					B17	03	A17	13	
					B16	04	A16	14	
					B15	05	A15	15	
					B14	06	A14	16	
					B13	07	A13	17	
					B12	08	A12	18	
					B11	09	A11	19	
					B10	0A	A10	1A	
					B09	0B	A09	1B	
					B08	0C	A08	1C	
					B07	0D	A07	1D	
					B06	0E	A06	1E	
					B05	0F	A05	1F	
					B04	NC	A04	NC	
B03	NC	A03	NC						
B02	DC12/24V	A02	COM						
B01		A01							

Chapter 3 Input/Output Specification

3.5.7 8 point transistor output module (Source type)







Specification		Model	Transistor output module				
			XBE-TP08A				
Output point		8 point					
Insulation method		Photo coupler insulation					
Rated load voltage		DC 12 / 24V					
Load voltage range		DC 10.2 ~ 26.4V					
Max. load voltage		0.5A / 1 point					
Off leakage current		0.1mA or less					
Max. inrush current		4A / 10ms or less					
Max. voltage drop (On)		DC 0.4V or less					
Surge absorber		Zener Diode					
Response time	Off → On	1ms or less					
	On → Off	1ms or less (Rated load, resistive load)					
Common method		8 point / COM					
Proper cable size		Stranded cable 0.3~0.75mm ² (external diameter 2.8mm or less)					
Current consumption		40mA (when all outputs are on)					
External power	Voltage	DC12/24V ± 10% (ripple voltage 4 Vp-p or less)					
	Current	10mA or less (when connecting DC24V)					
Operation indicator		LED on when output on					
External connection method		10 pin terminal block connector					
Weight		30g					
Circuit configuration					No.	Contact	Type
					TB01	0	
					TB02	1	
					TB03	2	
					TB04	3	
					TB05	4	
					TB06	5	
					TB07	6	
					TB08	7	
					TB09	COM	
					TB10	0V	

3.5.8 16 point transistor output module (Source type)

Model		Transistor output module			
Specification		XBE-TP16A			
Output point		16 point			
Insulation method		Photo coupler insulation			
Rated load voltage		DC 12 / 24V			
Load voltage range		DC 10.2 ~ 26.4V			
Max. load voltage		0.5A / 1 point, 2A / 1COM			
Off leakage current		0.1mA or less			
Max. inrush current		4A / 10ms or less			
Max. voltage drop (On)		DC 0.4V or less			
Surge absorber		Zener Diode			
Response time	Off → On	1ms or less			
	On → Off	1ms or less (Rated load, resistive load)			
Common method		16 point / COM			
Proper cable size		Stranded cable 0.3~0.75mm ² (external diameter 2.8mm or less)			
Current consumption		60mA (When all outputs are on)			
External power	Voltage	DC12/24V ± 10% (ripple voltage 4 Vp-p or less)			
	Current	10mA or less (connecting DC24V)			
Operation indicator		LED On when output On			
External connection method		8 pin terminal block connector + 10 pin terminal block connector			
Weight		40g			
Circuit configuration					
		No.	Contact	Type	
		TB01	0	TB01	
		TB02	1	TB02	
		TB03	2	TB03	
		TB04	3	TB04	
		TB05	4	TB05	
		TB06	5	TB06	
		TB07	6	TB07	
		TB08	7	TB08	
		TB01	8	TB01	
		TB02	9	TB02	
		TB03	A	TB03	
		TB04	B	TB04	
		TB05	C	TB05	
		TB06	D	TB06	
		TB07	E	TB07	
TB08	F	TB08			
TB09	COM	TB09			
TB10	0V	TB10			

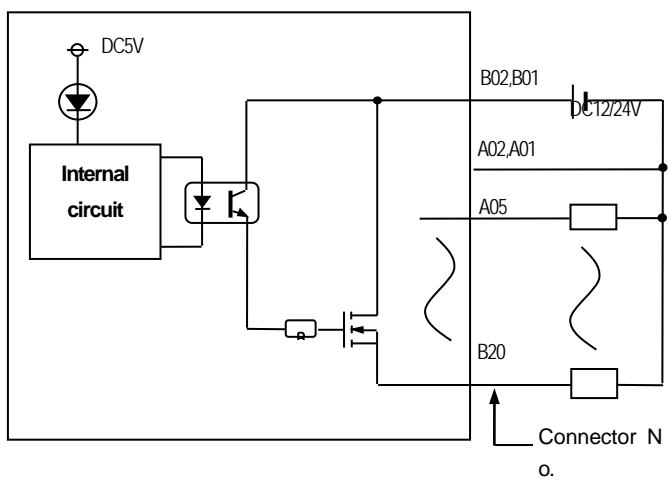
Chapter 3 Input/Output Specification

3.5.9 32 point transistor output module (Source type)

Specification		Model	Transistor output module																																																																																											
			XBE-TP32A																																																																																											
Output point		32 point																																																																																												
Insulation method		Photo coupler insulation																																																																																												
Rated load voltage		DC 12 / 24V																																																																																												
Load voltage range		DC 10.2 ~ 26.4V																																																																																												
Max. load voltage		0.2A / 1 point, 2A / 1COM																																																																																												
Off leakage current		0.1mA or less																																																																																												
Max. inrush current		4A / 10 ms or less																																																																																												
Max. voltage drop (On)		DC 0.4V or less																																																																																												
Surge absorber		Zener Diode																																																																																												
Response time	Off → On	1ms or less																																																																																												
	On → Off	1ms or less (Rated load, resistive load)																																																																																												
Common method		32 point / COM																																																																																												
Proper cable size		0.3mm ²																																																																																												
Current consumption		120mA (When all outputs are on)																																																																																												
External power	Voltage	DC12/24V ± 10% (ripple voltage 4 Vp-p or less)																																																																																												
	Current	20mA or less (connecting DC24V)																																																																																												
Operation indicator		LED On when output On																																																																																												
External connection method		40 pin connector																																																																																												
Weight		60g																																																																																												
Circuit configuration						<table border="1"> <thead> <tr> <th>No.</th> <th>Contact</th> <th>No.</th> <th>Contact</th> <th>Type</th> </tr> </thead> <tbody> <tr><td>B20</td><td>00</td><td>A20</td><td>10</td><td rowspan="33"></td></tr> <tr><td>B19</td><td>01</td><td>A19</td><td>11</td></tr> <tr><td>B18</td><td>02</td><td>A18</td><td>12</td></tr> <tr><td>B17</td><td>03</td><td>A17</td><td>13</td></tr> <tr><td>B16</td><td>04</td><td>A16</td><td>14</td></tr> <tr><td>B15</td><td>05</td><td>A15</td><td>15</td></tr> <tr><td>B14</td><td>06</td><td>A14</td><td>16</td></tr> <tr><td>B13</td><td>07</td><td>A13</td><td>17</td></tr> <tr><td>B12</td><td>08</td><td>A12</td><td>18</td></tr> <tr><td>B11</td><td>09</td><td>A11</td><td>19</td></tr> <tr><td>B10</td><td>0A</td><td>A10</td><td>1A</td></tr> <tr><td>B09</td><td>0B</td><td>A09</td><td>1B</td></tr> <tr><td>B08</td><td>0C</td><td>A08</td><td>1C</td></tr> <tr><td>B07</td><td>0D</td><td>A07</td><td>1D</td></tr> <tr><td>B06</td><td>0E</td><td>A06</td><td>1E</td></tr> <tr><td>B05</td><td>0F</td><td>A05</td><td>1F</td></tr> <tr><td>B04</td><td>NC</td><td>A04</td><td>NC</td></tr> <tr><td>B03</td><td>NC</td><td>A03</td><td>NC</td></tr> <tr><td>B02</td><td>COM</td><td>A02</td><td>0V</td></tr> <tr><td>B01</td><td>COM</td><td>A01</td><td>0V</td></tr> </tbody> </table>	No.	Contact	No.	Contact	Type	B20	00	A20	10		B19	01	A19	11	B18	02	A18	12	B17	03	A17	13	B16	04	A16	14	B15	05	A15	15	B14	06	A14	16	B13	07	A13	17	B12	08	A12	18	B11	09	A11	19	B10	0A	A10	1A	B09	0B	A09	1B	B08	0C	A08	1C	B07	0D	A07	1D	B06	0E	A06	1E	B05	0F	A05	1F	B04	NC	A04	NC	B03	NC	A03	NC	B02	COM	A02	0V	B01	COM	A01	0V		
No.	Contact	No.	Contact	Type																																																																																										
B20	00	A20	10																																																																																											
B19	01	A19	11																																																																																											
B18	02	A18	12																																																																																											
B17	03	A17	13																																																																																											
B16	04	A16	14																																																																																											
B15	05	A15	15																																																																																											
B14	06	A14	16																																																																																											
B13	07	A13	17																																																																																											
B12	08	A12	18																																																																																											
B11	09	A11	19																																																																																											
B10	0A	A10	1A																																																																																											
B09	0B	A09	1B																																																																																											
B08	0C	A08	1C																																																																																											
B07	0D	A07	1D																																																																																											
B06	0E	A06	1E																																																																																											
B05	0F	A05	1F																																																																																											
B04	NC	A04	NC																																																																																											
B03	NC	A03	NC																																																																																											
B02	COM	A02	0V																																																																																											
B01	COM	A01	0V																																																																																											
																																																																																														
<table border="1"> <thead> <tr> <th>No.</th> <th>Contact</th> <th>No.</th> <th>Contact</th> <th>Type</th> </tr> </thead> <tbody> <tr><td>B20</td><td>00</td><td>A20</td><td>10</td><td rowspan="33"></td></tr> <tr><td>B19</td><td>01</td><td>A19</td><td>11</td></tr> <tr><td>B18</td><td>02</td><td>A18</td><td>12</td></tr> <tr><td>B17</td><td>03</td><td>A17</td><td>13</td></tr> <tr><td>B16</td><td>04</td><td>A16</td><td>14</td></tr> <tr><td>B15</td><td>05</td><td>A15</td><td>15</td></tr> <tr><td>B14</td><td>06</td><td>A14</td><td>16</td></tr> <tr><td>B13</td><td>07</td><td>A13</td><td>17</td></tr> <tr><td>B12</td><td>08</td><td>A12</td><td>18</td></tr> <tr><td>B11</td><td>09</td><td>A11</td><td>19</td></tr> <tr><td>B10</td><td>0A</td><td>A10</td><td>1A</td></tr> <tr><td>B09</td><td>0B</td><td>A09</td><td>1B</td></tr> <tr><td>B08</td><td>0C</td><td>A08</td><td>1C</td></tr> <tr><td>B07</td><td>0D</td><td>A07</td><td>1D</td></tr> <tr><td>B06</td><td>0E</td><td>A06</td><td>1E</td></tr> <tr><td>B05</td><td>0F</td><td>A05</td><td>1F</td></tr> <tr><td>B04</td><td>NC</td><td>A04</td><td>NC</td></tr> <tr><td>B03</td><td>NC</td><td>A03</td><td>NC</td></tr> <tr><td>B02</td><td>COM</td><td>A02</td><td>0V</td></tr> <tr><td>B01</td><td>COM</td><td>A01</td><td>0V</td></tr> </tbody> </table>							No.	Contact	No.	Contact	Type	B20	00	A20	10			B19	01	A19	11	B18	02	A18	12	B17	03	A17	13	B16	04	A16	14	B15	05	A15	15	B14	06	A14	16	B13	07	A13	17	B12	08	A12	18	B11	09	A11	19	B10	0A	A10	1A	B09	0B	A09	1B	B08	0C	A08	1C	B07	0D	A07	1D	B06	0E	A06	1E	B05	0F	A05	1F	B04	NC	A04	NC	B03	NC	A03	NC	B02	COM	A02	0V	B01	COM	A01	0V	
No.	Contact	No.	Contact		Type																																																																																									
B20	00	A20	10																																																																																											
B19	01	A19	11																																																																																											
B18	02	A18	12																																																																																											
B17	03	A17	13																																																																																											
B16	04	A16	14																																																																																											
B15	05	A15	15																																																																																											
B14	06	A14	16																																																																																											
B13	07	A13	17																																																																																											
B12	08	A12	18																																																																																											
B11	09	A11	19																																																																																											
B10	0A	A10	1A																																																																																											
B09	0B	A09	1B																																																																																											
B08	0C	A08	1C																																																																																											
B07	0D	A07	1D																																																																																											
B06	0E	A06	1E																																																																																											
B05	0F	A05	1F																																																																																											
B04	NC	A04	NC																																																																																											
B03	NC	A03	NC																																																																																											
B02	COM	A02	0V																																																																																											
B01	COM	A01	0V																																																																																											

3.6 Combined Digital I/O module Input Specification

3.6.1 8 point DC24V input (Source/Sink type)

Specification		Model	DC input module		
		XBE-DR16A			
Input point		8 point			
Insulation method		Photo coupler insulation			
Rated input voltage		DC24V			
Rated input current		About 4mA			
Operation voltage range		DC20.4~28.8V (within ripple rate 5%)			
On Voltage/Current		DC19V or higher / 3mA or higher			
Off Voltage/Current		DC6V or less / 1mA or less			
Input resistance		About 5.6kΩ			
Response time	Off → On	1/3/5/10/20/70/100ms (set by CPU parameter) Default: 3ms			
	On → Off				
Insulation pressure		AC560Vrms / 3Cycle (altitude 2000m)			
Insulation resistance		10MΩ or more by Megohmmeter			
Common method		8 point / COM			
Proper cable size		Stranded cable 0.3~0.75mm ² (External diameter 2.8mm or less)			
Current consumption		280mA (When all inputs and outputs are on)			
Operation indicator		LED on when input on			
External connection method		9 pin terminal block connector			
Weight		81g			
Circuit configuration			No.	Contact	Type
<p>Terminal block no.</p>			TB1	0	
			TB2	1	
			TB3	2	
			TB4	3	
			TB5	4	
			TB6	5	
			TB7	6	
			TB8	7	
			TB9	COM	

Chapter 3 Input/Output Specification

3.7 Combined Digital I/O module Output Specification

3.7.1 8 point relay output

Specification		Model	Relay output module		
			XBE-DR16A		
Output point		8 point			
Insulation method		Relay insulation			
Rated load voltage / Current		DC24V 2A (Resistive load) / AC220V 2A (COS Ψ = 1), 5A/COM			
Min. load voltage/Current		DC5V / 1mA			
Max. load voltage		AC250V, DC125V			
Off leakage current		0.1mA (AC220V, 60Hz)			
Max. On/Off frequency		3,600 times/hr			
Surge absorber		None			
Service life	Mechanical	20 millions times or more			
	Electrical	Rated load voltage / current 100,000 times or more			
		AC200V / 1.5A, AC240V / 1A (COS Ψ = 0.7) 100,000 times or more			
		AC200V / 1A, AC240V / 0.5A (COS Ψ = 0.35) 100,000 times or more			
		DC24V / 1A, DC100V / 0.1A (L / R = 7ms) 100,000 times or more			
Response time	Off \rightarrow On	10ms or less			
	On \rightarrow Off	12ms or less			
Common method		8 point / COM			
Proper cable size		Stranded cable 0.3~0.75mm ² (external diameter 2.8mm or less)			
Current consumption		280mA (When all inputs and outputs are on)			
Operation indicator		LED on when output on			
External connection method		9 pin terminal block connector			
Weight		81g			
Circuit configuration					
<p>The diagram illustrates the internal circuit of the relay output module. It shows a DC5V source connected to an internal circuit. The internal circuit is connected to a terminal block with terminals TB1 through TB9. The terminal block is connected to a load and a common terminal (COM). The terminal block is shown as a 9-pin connector with terminals TB1 through TB9 and a common terminal (COM).</p>			No.	Contact	Type
			TB1	0	
			TB2	1	
			TB3	2	
			TB4	3	
			TB5	4	
			TB6	5	
			TB7	6	
			TB8	7	
			TB9	COM	

3.8 I/O modules' Functions

3.8.1 Input filter function

The XGB PLC's input modules have the input filter function to prevent the external noise signal flowed into the input signal. For more details on the input filter function, refer to the below.

(1) Purposes and Operations of the input filter function

Under the environment with serious noise or in the case of the equipment that is greatly affected by the input signal's pulse width, the system may receive incorrect input depending on the input signal status. To prevent such incorrect input, the input filter function does not regard the signal that is shorter than the set time by a user as input. In the case of the XGB PLC, you can set the input filter time in the range of 1ms~100ms.

The below timing chart represents the operations of the input filter function.

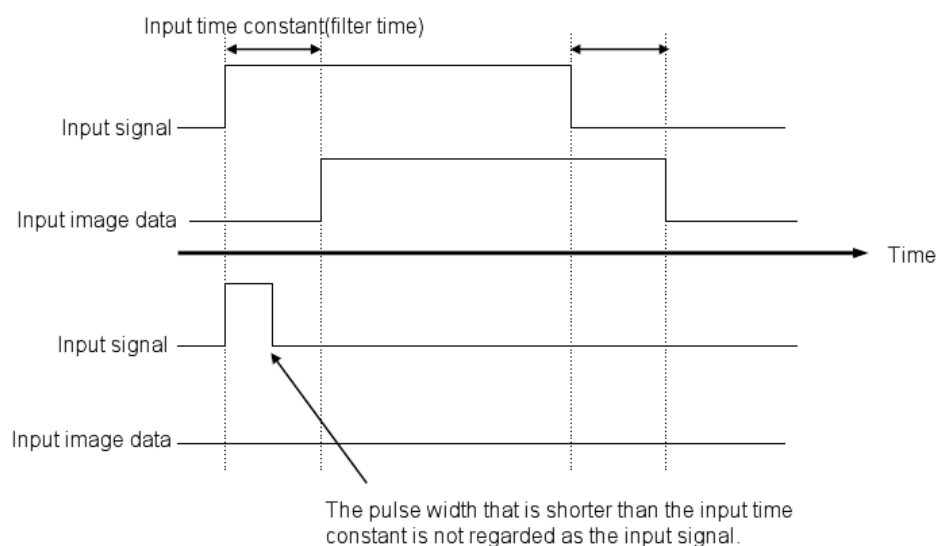

Chapter 3 Input/Output Specification

3.8.2 Emergency output function

The XGB PLC's output module supports the emergency output function to determine whether maintaining the output status of the output module or clearing it when the PLC is stopped due to errors.

You can set the emergency output by 8 points. For more details on how to set the emergency output, refer to the below.

(1) Output condition when an error occur

1) Click I/O module when error occurs

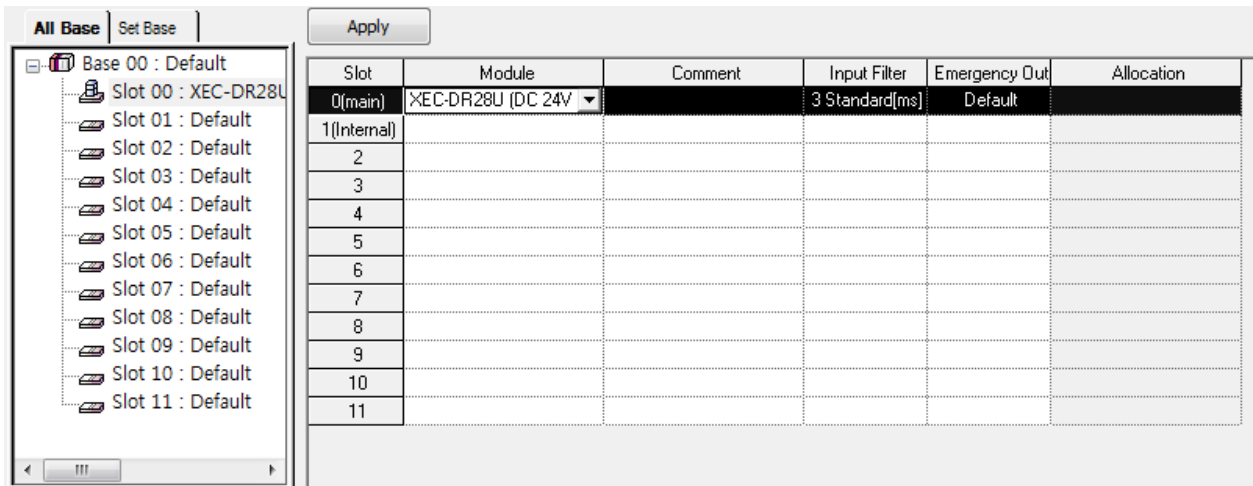

2) Click emergency output

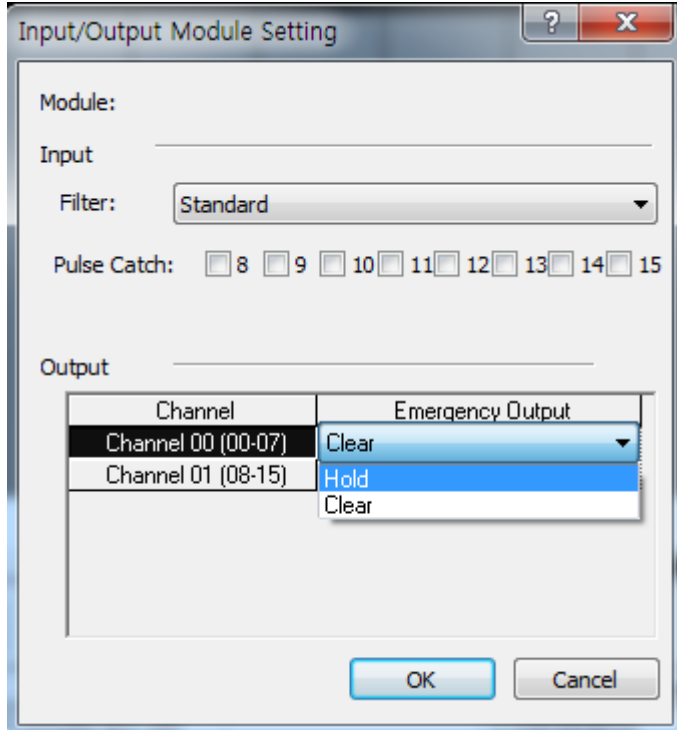

If setting Clear output will go off when error occurs, while If setting Hold output will go on.

3.8.3 Pulse Catch Function

The XGB PLC basic unit has the input contacts (P0008 ~ P000F) for Pulse Catch with 8 points. Through these contacts, it is possible to receive the very short pulse signal that cannot be recognized by the normal digital input.

(1) Purposes and Operations of the Pulse Catch function

The PLC's input data is refreshed in a lump once every scan. Accordingly, the very short pulse signal that is input during scan and is off before the scan is finished cannot be recognized as input. If you need to recognize and process such short pulse signal, you can use the Pulse Catch function. If you apply this function, the short pulse of the minimum of $50\mu\text{s}$ can be recognized.

The below timing chart represents the operations of the Pulse Catch function.

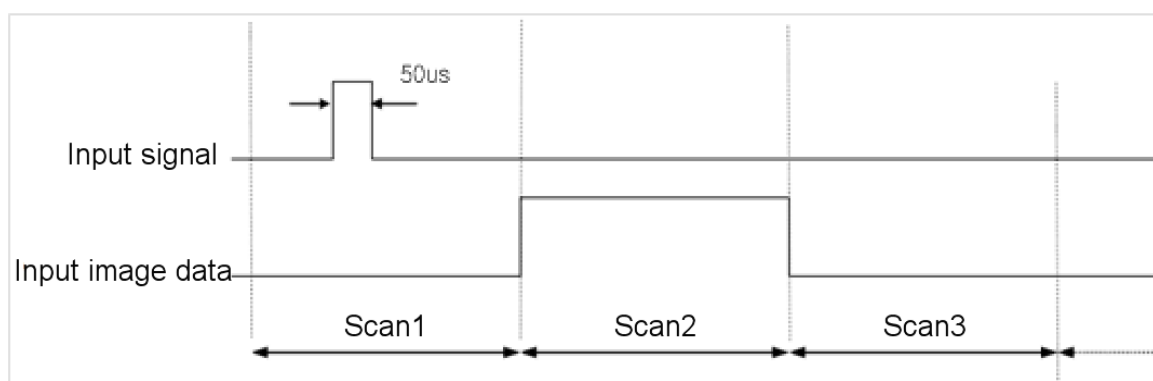

Step	Processing details
Scan 1	When the minimum pulse signal of $50\mu\text{s}$ is input, the CPU part will detect the fact and save the status.
Scan 2	The input image data area is On.
Scan 3	The input image data area is Off.

(2) Setting Pulse Catch

- 1) Select [I/O parameter] in Project

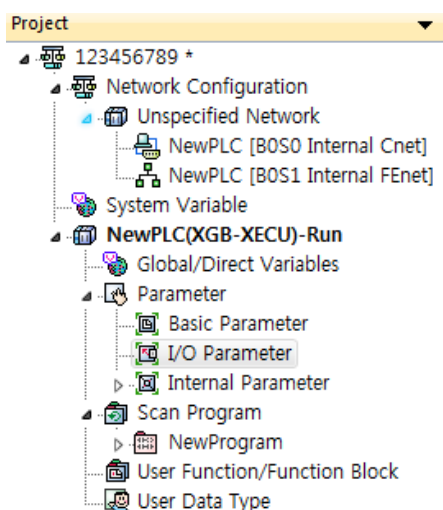

Chapter 3 Input/Output Specification

2) Select [Main] in slot.

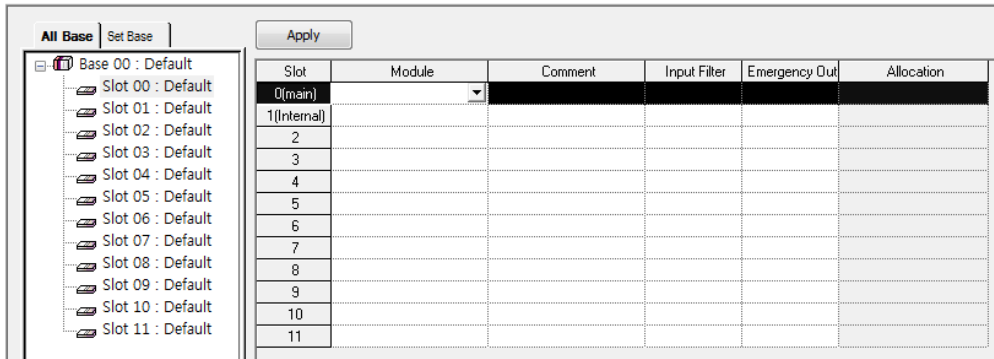

3) Select Module.

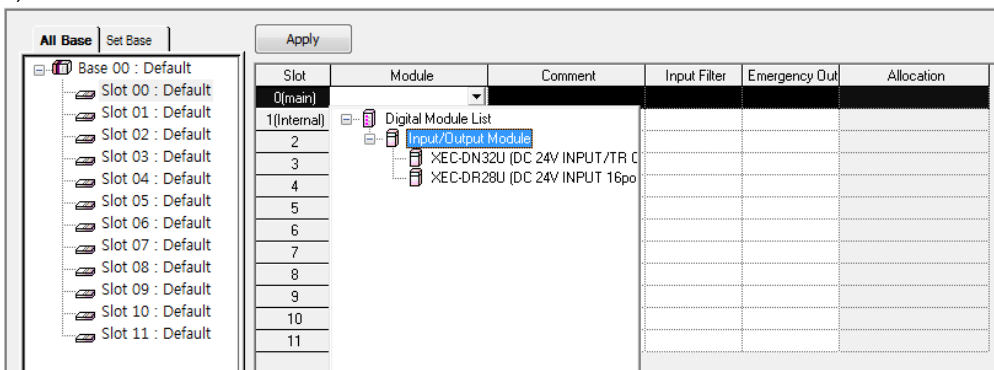

4) Double Click I/O Module. Select Pulse Catch output

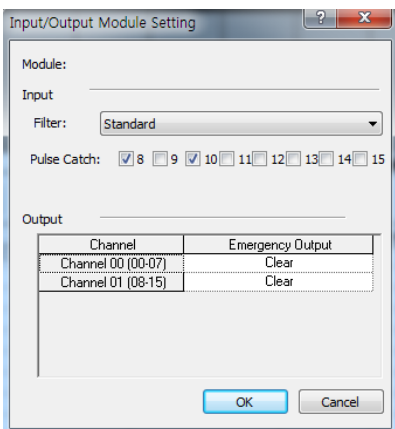
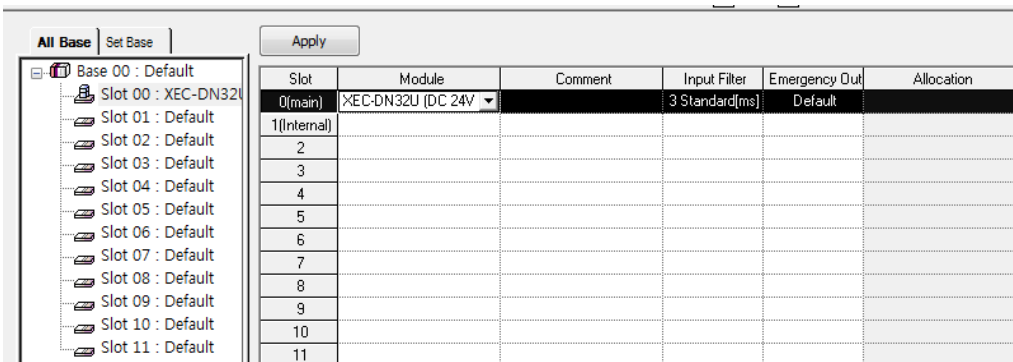

Chapter 4 Built-in High-speed Counter Function

XGB series have built-in function of High-speed counter in main unit. This chapter describes specifications and usage of High-speed counter's function

4.1 High-speed Counter Specifications

4.1.1 Performance Specifications

(1) Performance specifications

Classification		Spcification
Count input signal	Signal	A-phase, B-phase
	Input type	Voltage input (Open collector)
	Signal level	DC 24V
Max. count speed		100kpps
Number of channels	1 phase	100kpps 8 channels
	2 phase	50kpps 4 channels
Count range		Signed 32 Bit (-2,147,483,648 ~ 2,147,483,647)
Count mode (Program setting)		Linear count (if 32-bit range exceeded, Carry/Borrow occurs) Counter max. and min. value is indicated
		Ring count (repeated count within setting range)
Input mode (Program setting)		1-phase input
		2-phase input
		CW/CCW input
Signal type		Voltage
Up/Down setting	1 phase input	Increasing/decreasing operation setting by B-phase input
		Increasing/decreasing operation setting by program
	2 phase input	Operating setting by rising/falling edge phase difference
	CW/CCW	A-phase input: increasing operation
B-phase input: decreasing operation		
Multiplication function	1 phase input	1 multiplication
	2 phase input	4 multiplication
	CW/CCW	1 multiplication
Control input	Signal	Preset instruction input(P0008 ~ P000F)
	Signal level	DC 24V input type
	Signal type	Voltage

Classification		Spcification
External output	Output points	2 point/channel (for each channel):use output contact point of main unit
	Type	Selects single-compared (>, >=, =, =<, <) or section-compared output (included or excluded) (program setting)
	Output type	Transistor output
Count Enable		To be set through program (count available only in enable status)
Preset function		To be set through terminal (contact) or program
Auxiliary mode (Program setting)		Count Latch Frequency Measure Count per unit time (time setting value: 1~60,000ms) Count pause

(2) Counter/Preset input specification

Classification	Spcification
Input voltage	24V DC (20.4V ~ 28.8V)
Input current	4mA
On guaranteed voltage (min.)	20.4V
Off guaranteed voltage (max.)	6V

4.1.2 Designation of Parts

(1) Designation of parts

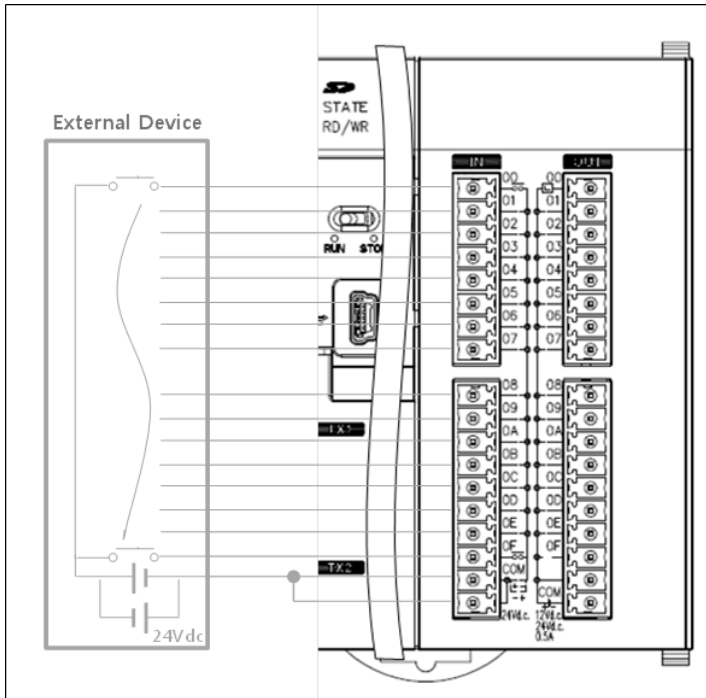

Terminal No.	Names		Usage	
	1-phase	2-phase	1-phase	2-phase
%IX0.0.0	Ch0 counter input	Ch0 A-phase input	counter input terminal	A-phase input terminal
%IX0.0.1	Ch1 counter input	Ch0 B-phase input	counter input terminal	B-phase input terminal
%IX0.0.2	Ch2 counter input	Ch2 A-phase input	counter input terminal	A-phase input terminal
%IX0.0.3	Ch3 counter input	Ch2 B-phase input	counter input terminal	B-phase input terminal
%IX0.0.4	Ch4 counter input	Ch4 A-phase input	counter input terminal	A-phase input terminal
%IX0.0.5	Ch5 counter input	Ch4 B-phase input	counter input terminal	B-phase input terminal
%IX0.0.6	Ch6 counter input	Ch6 A-phase input	counter input terminal	A-phase input terminal
%IX0.0.7	Ch7 counter input	Ch6 B-phase input	counter input terminal	B-phase input terminal
%IX0.0.8	Ch0 preset 24V	Ch0 preset 24V	preset input terminal	preset input terminal
%IX0.0.9	Ch1 preset 24V	-	preset input terminal	No use
%IX0.0.10	Ch2 preset 24V	Ch2 preset 24V	preset input terminal	preset input terminal
%IX0.0.11	Ch4 preset 24V	-	preset input terminal	No use
%IX0.0.12	Ch5 preset 24V	Ch4 preset 24V	preset input terminal	preset input terminal
%IX0.0.13	Ch6 preset 24V	-	preset input terminal	No use
%IX0.0.14	Ch7 preset 24V	Ch6 preset 24V	preset input terminal	preset input terminal
%IX0.0.15	Ch8 preset 24V	-	preset input terminal	No use
COM0	input common	input common	common terminal	common terminal

(2) Interface with external devices

I/O	Internal circuit	Terminal No.	Signal Name		Operation	On/Off Guaranteed voltage	
			1-phase	2-phase			
Input		%IX0.0.0	Ch0 pulse input	Ch 0 A-phase input	On	20.4~28.8V	
		%IX0.0.1	Ch 1 pulse input	Ch 0 B-phase input	Off	6V or less	
		%IX0.0.2	Ch 2 pulse input	Ch 2 A-phase input	On	20.4~28.8V	
		%IX0.0.3	Ch 3 pulse input	Ch 2 B-phase input	Off	6V or less	
		%IX0.0.4	Ch4 pulse input	Ch 4 A-phase input	On	20.4~28.8V	
		%IX0.0.5	Ch 5 pulse input	Ch 4 B-phase input	Off	6V or less	
		%IX0.0.6	Ch 6 pulse input	Ch 6 A-phase input	On	20.4~28.8V	
		%IX0.0.7	Ch 7 pulse input	Ch 6 B-phase input	Off	6V or less	
		%IX0.0.8	Ch 0 preset input	Ch 0 preset input	On	20.4~28.8V	
		%IX0.0.9	Ch 1 preset input	-	Off	6V or less	
		%IX0.0.10	Ch 2 preset input	Ch 2 preset input	On	20.4~28.8V	
		%IX0.0.11	Ch 3 preset input	-	Off	6V or less	
		%IX0.0.12	Ch 4 preset input	Ch 4 preset input	On	20.4~28.8V	
		%IX0.0.13	Ch 5 preset input	-	Off	6V or less	
		%IX0.0.14	Ch 6 preset input	Ch 6 preset input	On	20.4~28.8V	
		%IX0.0.15	Ch 7 preset input	-	Off	6V or less	
			COM0	COM(input common)			

4.1.3 Functions of High-speed Counter

(1) Counter mode

(a) High Speed counter function can count High Speed pulses which can not be processed by CPU module's counter instructions (CTU, CTD, CTUD, etc.), up to binary value of 32 bits (-2,147,483,648 ~ 2,147,483,647).

(b) Available input is 1-phase input, 2-phase input and CW/ CCW input.

(c) Count increasing/decreasing methods are as follows;

- For 1-phase input: a) Increasing/decreasing count operation by program setting
b) Increasing/decreasing count operation by B-phase input signal
- For 2-phase input: setting by difference in phase between A-phase and B-phase
- For CW/CCW input: Increasing operation if B-phase is LOW with A-phase input, and Decreasing operation if A-phase is LOW with B-phase input.

(d) Auxiliary modes are as follows;

- Latch counter
- Count function about the number of revolution per unit time
- Frequency measure function
- Count prohibited function

(e) Pulse input mode

1) 1 phase count mode

a) Increasing/decreasing count operation by program setting

- 1-phase 1-input 1-multiplication operation mode

A-phase input pulse counts at rising and increasing/decreasing will be decided by the applicable program.

Increasing/Decreasing classification	A-phase input pulse rising	A-phase input pulse falling
Increasing/decreasing count setting signal Off	Increasing count	-
Increasing/decreasing count setting signal On	Decreasing count	-

• Operation example

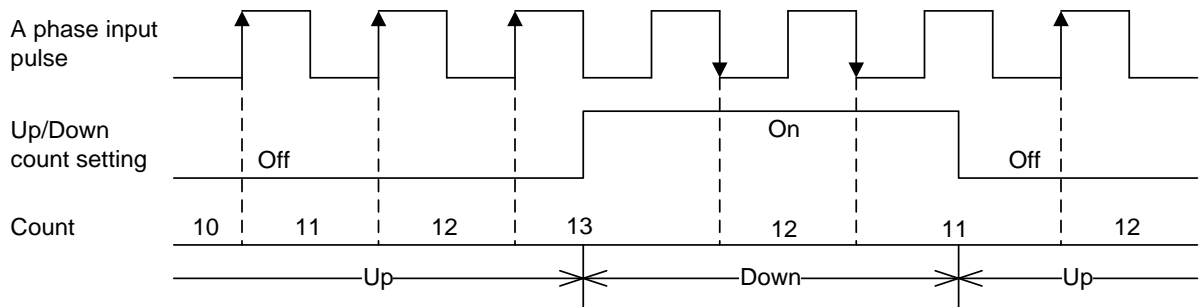

b) Increasing/decreasing count operation by B-phase input signal

- 1-phase 2-input 1-multiplication operation mode

A-phase input pulse counts at rising and increasing/decreasing will be decided by B-phase.

Increasing/Decreasing classification	A-phase input pulse rising	A-phase input pulse falling
B-phase input pulse Off	Increasing count	-
B-phase input pulse On	Decreasing count	-

• Operation example

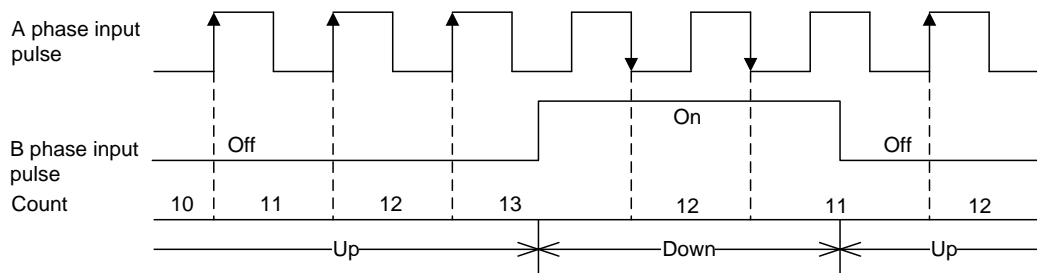

2) 2-phase count mode

a) 2-phase 4-multiplication operation mode

A-phase input pulse and B-phase input pulse count at rising/falling respectively. If A-phase input is antecedent to B-phase input, increasing operation starts, and if B-phase input is antecedent to A-phase input, decreasing operation starts.

• Operation example

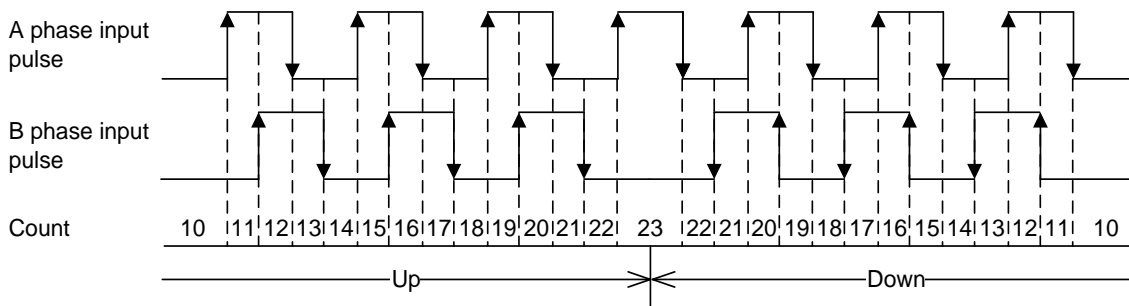

3) CW(Clockwise)/CCW(Counter Clockwise) operation mode

A-phase input pulse counts at rising, or B-phase input pulse counts at rising.

Increasing operation executed when B-phase input pulse is Low with A-phase input pulse at rising, and Decreasing operation executed when A-phase input pulse is Low with B-phase input pulse at rising.

Increasing/Decreasing classification	A-phase input pulse High	A-phase input pulse Low
B-phase input pulse High	-	decreasing count
B-phase input pulse Low	Increasing count	-

• Operation example

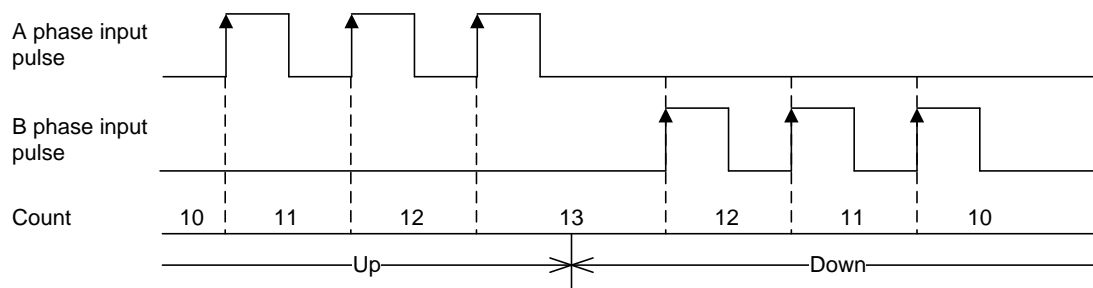

(2) Counter mode

2 types of count (Linear counter, Ring counter) can be selected for the applicable use based on functions.

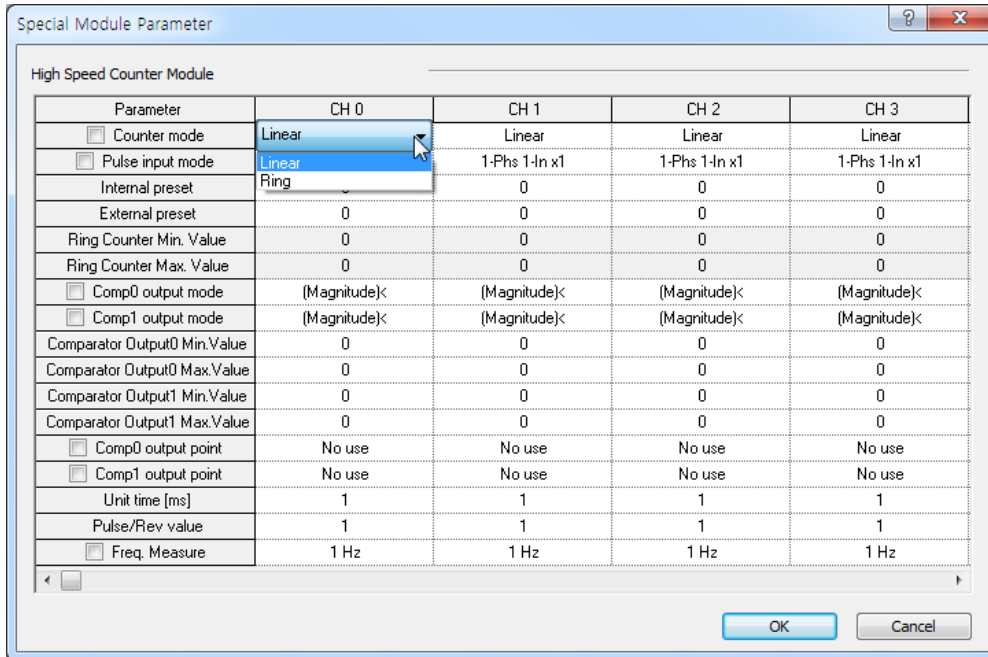

- Counter mode is saved at the following special K area.

Mode	Area per each channel (word)								Ref.
	Ch.0	Ch.1	Ch.2	Ch.3	Ch.4	Ch.5	Ch.6	Ch.7	
Counter mode	%KW300	%KW330	%KW360	%KW390	%KW2220	%KW2250	%KW2280	%KW2310	0 : linear 1 : ring

(a) Linear counter

- Linear Count range: -2,147,483,648 ~ 2,147,483,647
- If count value reaches the maximum value while increased, Carry will occur, and if count value reaches the minimum value while decreased, Borrow will occur.
- If Carry occurs, count stops and increasing is not available but decreasing is available.
- If Borrow occurs, count stops and decreasing is not available but increasing is available.

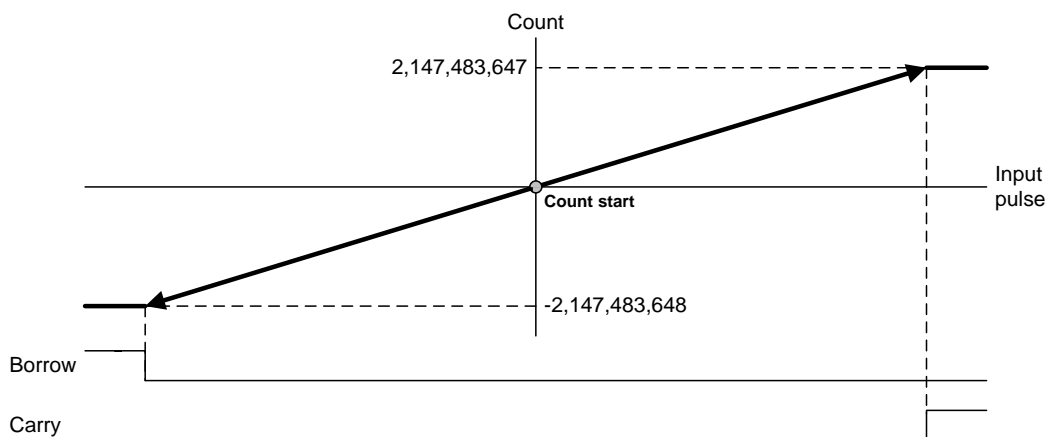

(b) Ring count

Set Ring Counter Min. Value and Max. value. Preset value and compared set value should be in range of ring counter min. value and max. value.

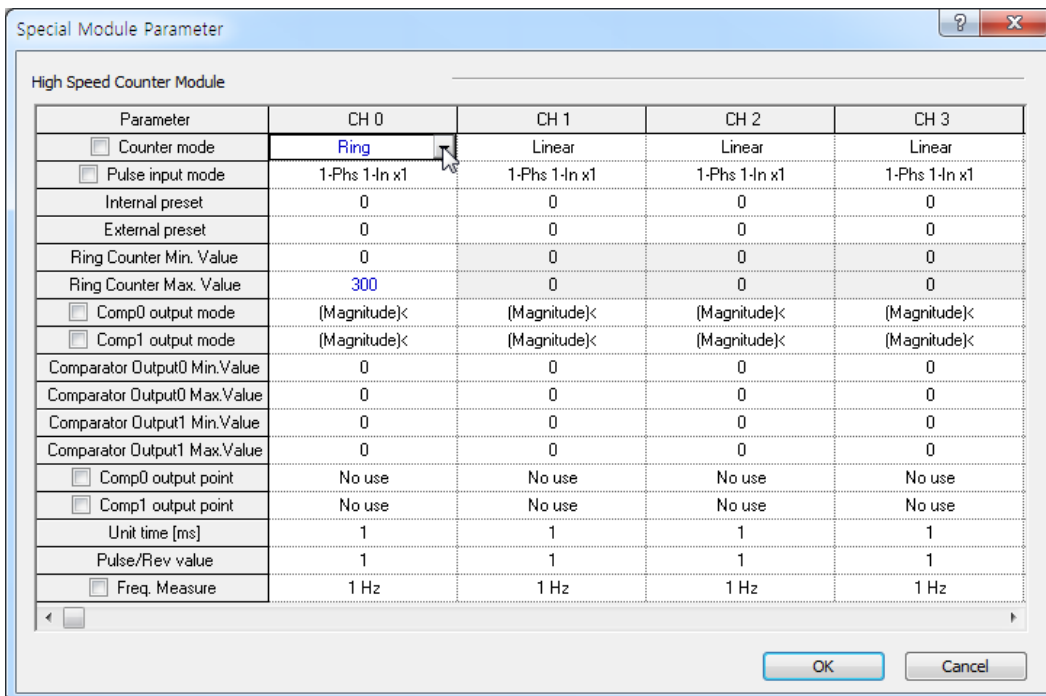

Ring counter max. and min value is saved at the following special K area.

type	Area per each channel (Double word)								Ref.
	Ch.0	Ch.1	Ch.2	Ch.3	Ch.4	Ch.5	Ch.6	Ch.7	
Ring counter min. value	%KD154	%KD169	%KD184	%KD199	%KD1114	%KD1129	%KD1144	%KD1159	-
Ring counter max. value	%KD155	%KD170	%KD185	%KD200	%KD1115	%KD1130	%KD1145	%KD1160	-

- Range of Ring counter: user defined min. value ~ user defined max. value
- Counter display: in case of using ring counter, user defined max. value is not displayed.

1) During increasing count

Even if count value exceeds user-defined maximum value during increasing count, Carry only occurs and count does not stop differently to Linear Count.

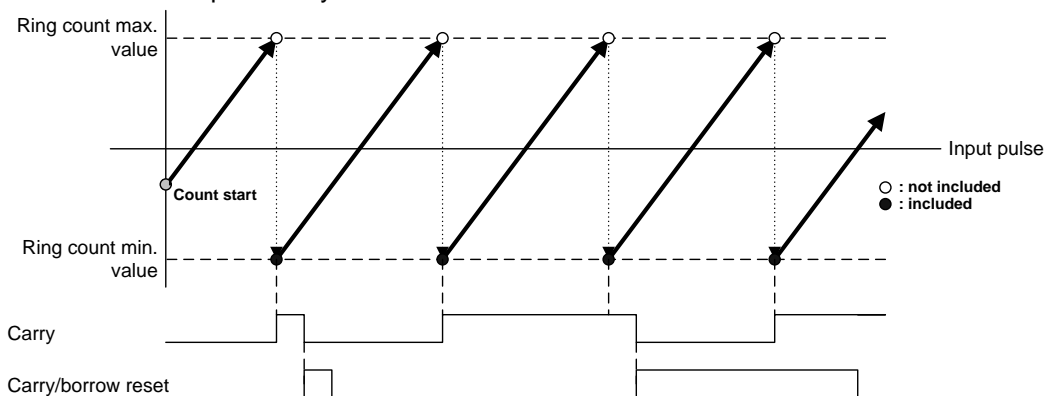

2) During decreasing count

Even if count value exceeds user-defined minimum value during decreasing count, Borrow only occurs and count does not stop differently to Linear Count.

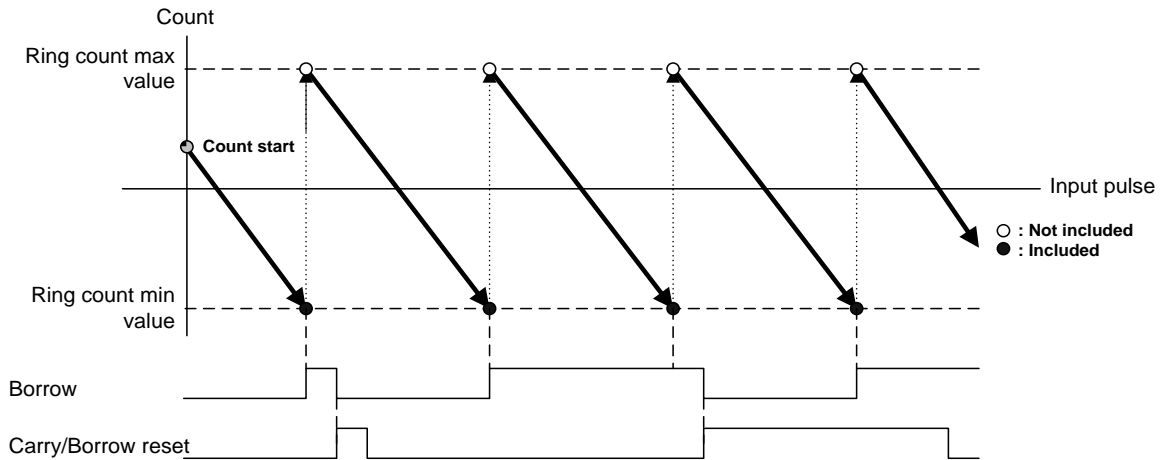

3) Operation when setting Ring Count based on present count value (during increasing count)

- If present count value exceeds user-defined range when setting Ring Count
 - Error (code no. 27) is occurred and it operates linear counter.
- If present count value is within user-defined range when setting Ring Count
 - Present count value starts to increase up to the user-defined maximum value and down to the user-defined minimum value and keeps counting after Carry occurs.
 - Not the maximum but the minimum value only is displayed with count kept on as shown below.

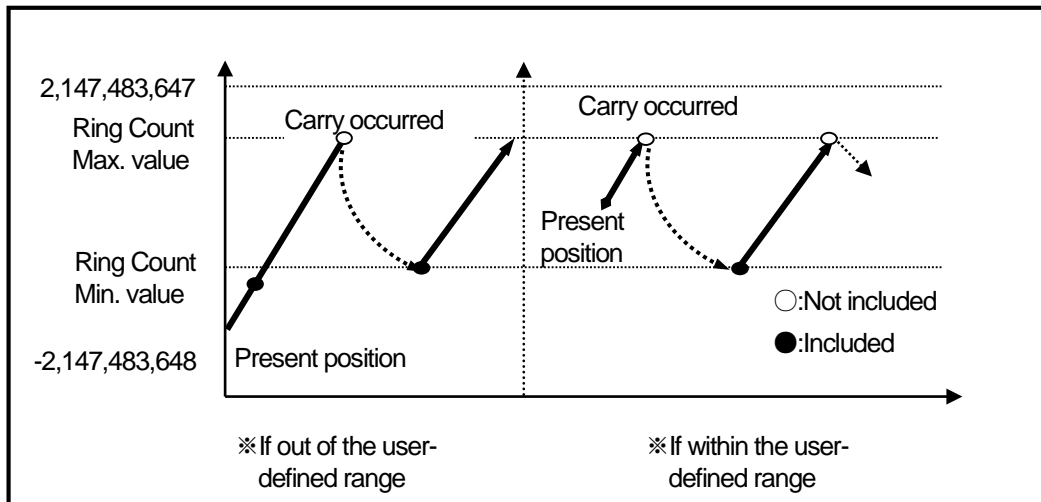

- 4) Operation when setting Ring Count based on present count value (during decreasing count)
- If present count value exceeds user-defined range when setting Ring Count
 - Error (code no. 27) is occurred and it operates linear counter. If the present count value goes into the ring count range, it operates ring counter.(The error code is not cleared.)
 - If present count value is within user-defined range when setting Ring Count
 - Present count value starts to decrease down to the user-defined minimum value and up to the user-defined maximum value and keeps counting after Borrow occurs.

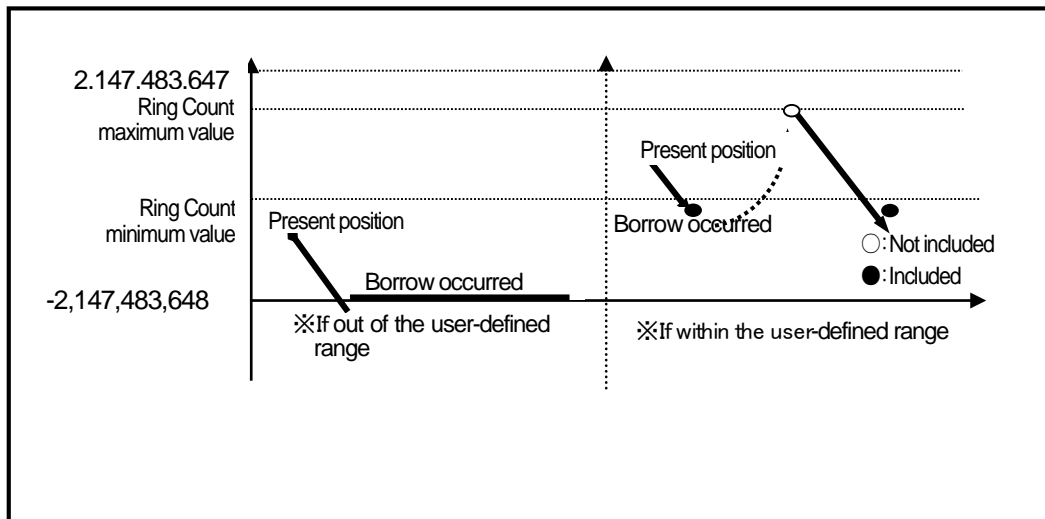

Remark

- (1) Based on count value within or out of user-defined range, count will be decided to be within or out of the range when setting Ring Count.
- (2) Ring Count setting when count value is out of the range is regarded as user's mistake. The count is not available within the Ring Count range.
- (3) Use preset function or the like when using Ring Count so to surely position the count value within the range.

(3) Compared output

- (a) High Speed counter module has a compared output function used to compare present count value with compared value in size to output as compared.
- (b) Available compared outputs are 2 for 1 channel, which can be used separately.
- (c) Compared output conditions are 7 associated with $>$, $=$, $<$.
- (d) Parameter setting

• Comp. output mode setting

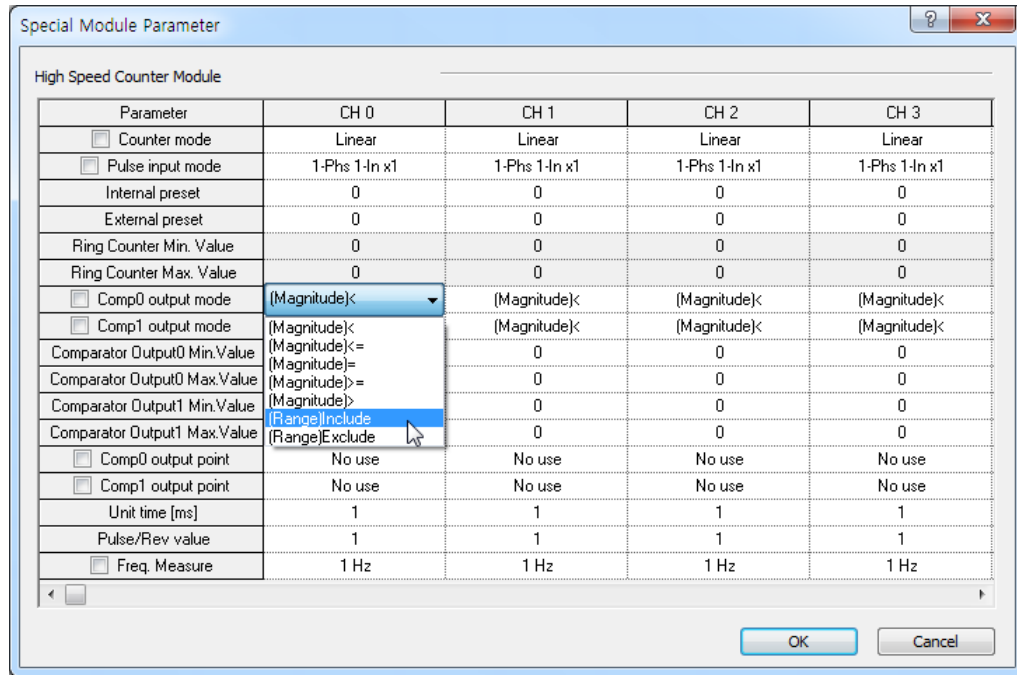

• Upper setting value is saved in special K area.

Compared output condition	Memory address (word)		Value ²⁾
	Comp output 0	Comp output 1	
Present Value < Compared Value			Set to "0"
Present Value ≤ Compared Value	Ch.0 %KW302	Ch.0 %KW 303	Set to "1"
Present Value = Compared Value	Ch.1 %KW 332	Ch.1 %KW 333	Set to "2"
Present Value ≥ Compared Value	Ch.2 %KW 362	Ch.2 %KW 363	Set to "3"
Present Value > Compared Value	Ch.3 %KW 392	Ch.3 %KW 393	Set to "4"
Compared value 1 ≤ Count value ≤ Compared value 2	Ch.4 %KW 2222	Ch.4 %KW 2223	Set to "5"
	Ch.5 %KW 2252	Ch.5 %KW 2253	
Count value ≤ Compared value 1, Count value ≥ Compared value 2	Ch.6 %KW 2282	Ch.6 %KW 2283	Set to "6"
	Ch.7 %KW 2312	Ch.7 %KW 2313	

²⁾ If compared output mode set value is other than 0~6 at using counter, error code '23' occurs.

Chapter 4 Built-in High-speed Counter Function

- In order to output the compared output signal, compared output enable flag set to '1' after compared output condition set.

Classification	Area per channel								Operation
	Ch. 0	Ch. 1	Ch. 2	Ch. 3	Ch. 4	Ch. 5	Ch. 6	Ch. 7	
Count enable signal	%KX4160	%KX4320	%KX4480	%KX4640	%KX3488 0	%KX3504 0	%KX3520 0	%KX3536 0	0: disable 1: enable
Compared 0 enable signal	%KX4164	%KX4324	%KX4484	%KX4644	%KX3488 4	%KX3504 4	%KX3520 4	%KX3536 4	0: disable 1: enable
Compared 1 enable signal	%KX4167	%KX4327	%KX4487	%KX4647	%KX3488 7	%KX3504 7	%KX3520 7	%KX3536 7	0: disable 1: enable

- In order to make external output, the compared coincidence output signal (P20~P2F) must be set. If Compared output contact is 'Off' at Special Module Parameter Setting of XG5000, Compared coincidence output signal (internal device) is only output.

Classification	Area per channel								Operation
	Ch. 0	Ch. 1	Ch. 2	Ch. 3	Ch. 4	Ch. 5	Ch. 6	Ch. 7	
Compared coincidence output signal 0	%KX4178	%KX4338	%KX4498	%KX4658	%KX34898	%KX35058	%KX35218	%KX35378	0: Compared mismatch 1: Compared match
Compared coincidence output signal 1	%KX4179	%KX4339	%KX4499	%KX4659	%KX34899	%KX35059	%KX35219	%KX35379	0: Compared mismatch 1: Compared match

- Comp. output point (P0020 ~ P002F) setting

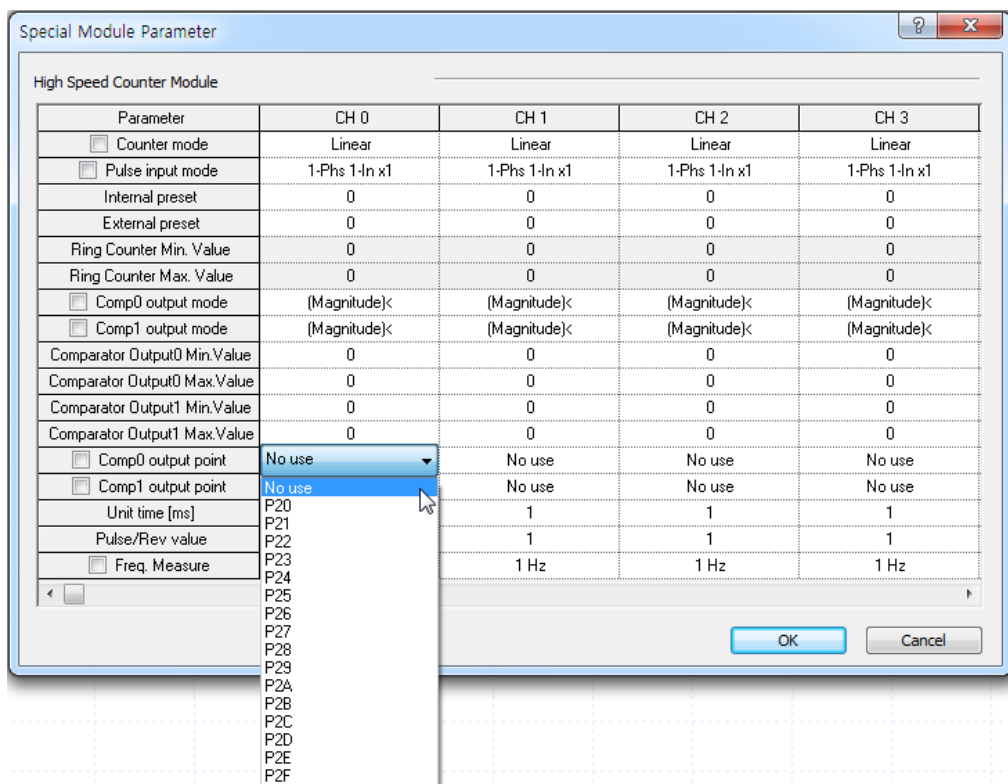

(e) Detail of comparator output

It describes detail of comparator output (based on comparator output 0)

1) Mode 0 (Present value < Compared value)

If counted present value is less than the minimum value of compared output 0, output is sent out, and if present value increases to be equal to or greater than the minimum value of compared output 0, output is not sent out.

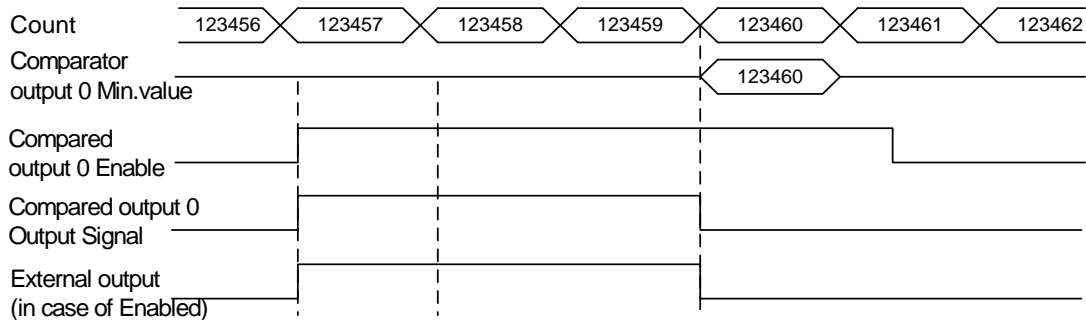

2) Mode1 (Count value ≤ Compared value)

If present count value is less than or equal to the minimum set value of compared output 0, output is sent out, and if count value increases to be greater than the minimum set value of compared output 0, output is not sent out.

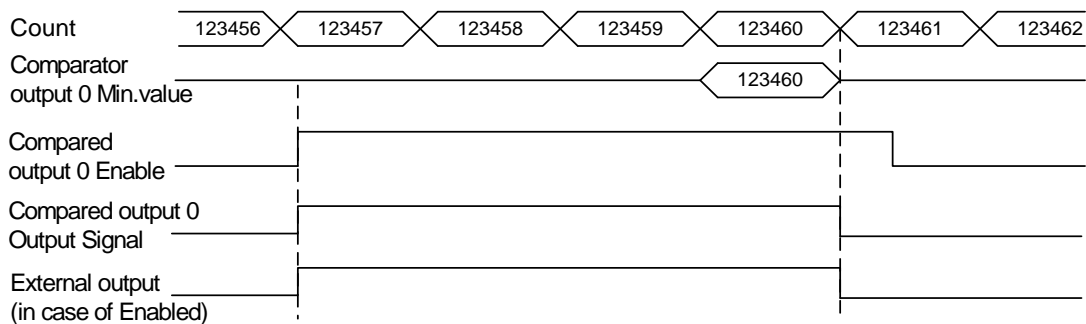

3) Mode 2 (Count value = Compared value)

If present count value is equal to the minimum set value of compared output 0, output is On. The output will keep turning on even if count value is changed from set value when count value is increased or decreased. In order to turn the output Off, Compared output Enable signal 0 is to be Off, or Compared match flag of K area and External output point are forced to be Off

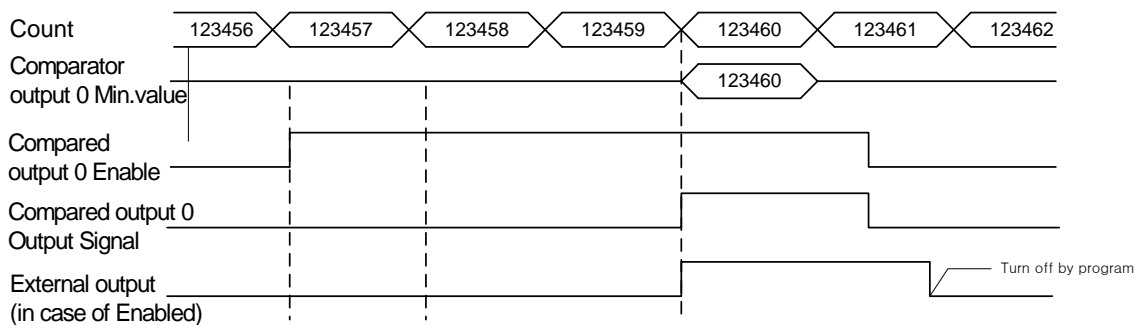

4) Mode 3 (Count value ≥ Compared value)

If present count value is greater than or equal to the minimum set value of compared output 0, output is sent out,

and if count value decreases to be less than the minimum set value of compared output 0, output is not sent out.

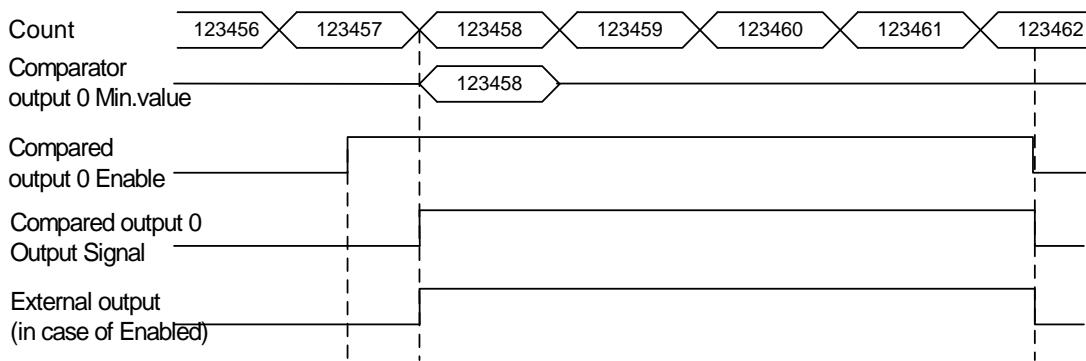

5) Mode 4 (Count value > Compared Output value)

If present count value is greater than the minimum set value of compared output 0, output is sent out, and if count value decreases to be less than or equal to the minimum set value of compared output 0, output is not sent out.

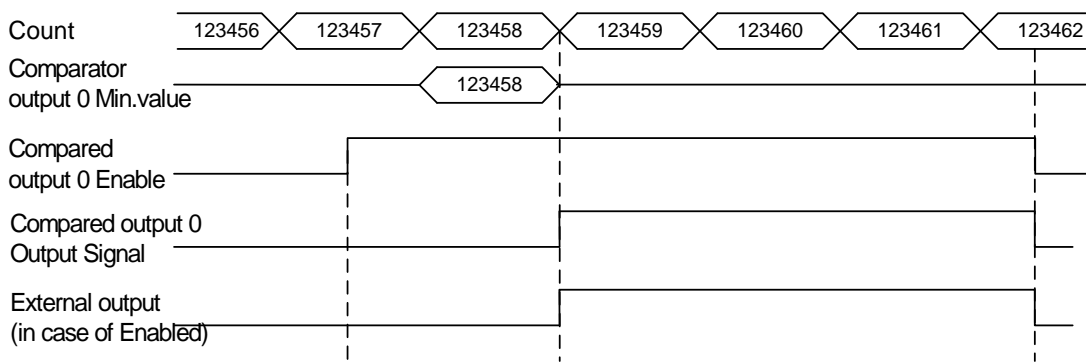

6) Mode 5

(Section comparison: Min. set value of Compared Output 0 \leq Count value \leq Max. set value of Compared Output 0)

If present count value is greater than or equal to the minimum set value of compared output 0 and less than or equal to the maximum set value of compared output 0, output is sent out, and if count value increases/decreases to exceed compared value's range, output is not sent out.

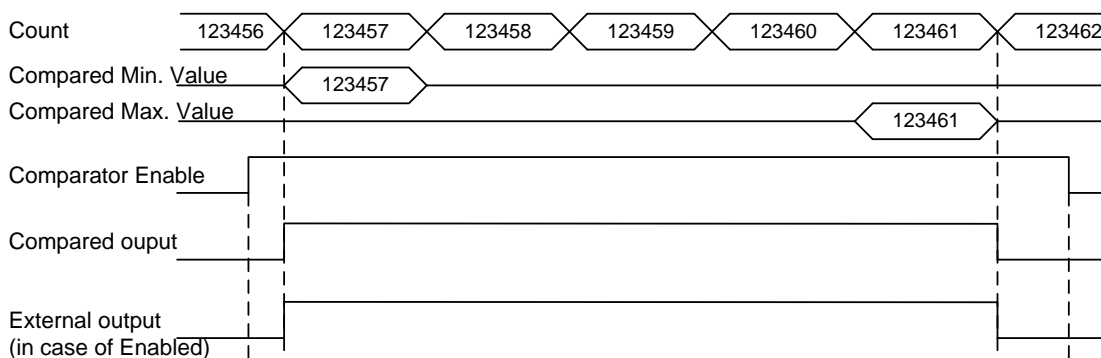

7) Mode 6 (Count value \leq Min. set value of Compared Output 0 or Count value \geq Max. set value of Compared Output 0)

If present count value is less than or equal to the minimum set value of compared 0 and greater than or equal to the

maximum set value of compared 0, output is sent out, and if count value increases/decreases to exceed compared value's range, output is not sent out.

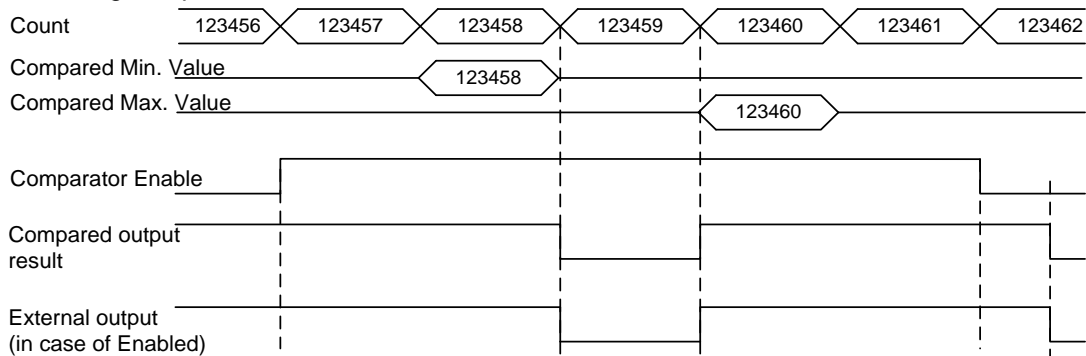

Remark

Ultimate performance XGB main unit checks present count value every 250 μ s and executes compared output function. Therefore, it can take maximum 250 μ s delay to detect compared condition.

(4) Carry signal

(a) Carry signal occurs

- 1) When count range maximum value of 2,147,483,647 is reached during Linear Count.
- 2) When user-defined maximum value of Ring Count changed to the minimum value during Ring Count.

(b) Count when Carry Signal occurs

- 1) Count stops if Carry occurs during Linear Count.
- 2) Count does not stop even if Carry occurs during Ring Count.

(c) Carry reset

- 1) The Carry generated can be cancelled by turning off the associated device area in the program.

Classification	Device area per channel (bit)							
	Ch.0	Ch.1	Ch.2	Ch.3	Ch.4	Ch.5	Ch.6	Ch.7
Carry signal	%KX4176	%KX4336	%KX4496	%KX4656	%KX34896	%KX35056	%KX35216	%KX35376

(5) Borrow signal

(a) Borrow signal occurs

- 1) When count range minimum value of -2,147,483,648 is reached during Linear Count.
- 2) When user-defined minimum value of Ring Count changed to the maximum value during Ring Count.

(b) Count when Borrow signal occurs

- 1) Count stops if Borrow occurs during Linear Count.
- 2) Count does not stop even if Borrow occurs during Ring Count.

(c) Borrow reset

- 1) The Borrow generated can be cancelled by turning off the associated device area in the program.

Classification	Device area per channel (bit)							
	Ch.0	Ch.1	Ch.2	Ch.3	Ch.4	Ch.5	Ch.6	Ch.7
Borrow signal	%KX4177	%KX4337	%KX4497	%KX4657	%KX34897	%KX35057	%KX35217	%KX35377

(6) Revolution/Unit time

While the Flag about the number of revolution per unit time is On, it counts the number of input pulses for the specified unit time so that the number of revolution per unit time is calculated.

(a) Setting

1) Set the unit time and the number of pulse per 1 revolution.

Parameter	CH 0	CH 1	CH 2	CH 3
<input type="checkbox"/> Counter mode	Linear	Linear	Linear	Linear
<input type="checkbox"/> Pulse input mode	1-Phs 1-In x1	1-Phs 1-In x1	1-Phs 1-In x1	1-Phs 1-In x1
Internal preset	0	0	0	0
External preset	0	0	0	0
Ring Counter Min. Value	0	0	0	0
Ring Counter Max. Value	0	0	0	0
<input type="checkbox"/> Comp0 output mode	(Magnitude)<	(Magnitude)<	(Magnitude)<	(Magnitude)<
<input type="checkbox"/> Comp1 output mode	(Magnitude)<	(Magnitude)<	(Magnitude)<	(Magnitude)<
Comparator Output0 Min.Value	0	0	0	0
Comparator Output0 Max.Value	0	0	0	0
Comparator Output1 Min.Value	0	0	0	0
Comparator Output1 Max.Value	0	0	0	0
<input type="checkbox"/> Comp0 output point	No use	No use	No use	No use
<input type="checkbox"/> Comp1 output point	No use	No use	No use	No use
Unit time [ms]	1000	1	1	1
Pulse/Rev value	500	1	1	1
<input type="checkbox"/> Freq. Measure	1 Hz	1 Hz	1 Hz	1 Hz

Setting value is saved at the following special K area and user can designate directly.

Class	Device per each channel (Word)								Setting range
	Ch.0	Ch.1	Ch.2	Ch.3	Ch.4	Ch.5	Ch.6	Ch.7	
Unit time	%KW322	%KW352	%KW382	%KW412	%KW2242	%KW272	%KW2302	%KW2332	1~60000ms
Pulse/Rev value	%KW323	%KW353	%KW383	%KW13	%KW2243	%KW2273	%KW2303	%KW2333	1~60000

2) In case of using Rev/unit time function, enable the following special K area

Class	Device per each channel (Word)								Operation
	Ch.0	Ch.1	Ch.2	Ch.3	Ch.4	Ch.5	Ch.6	Ch.7	
Rev/unit time command	%KX4165	%KX4325	%KX4485	%KX4645	%KX34885	%KX35045	%KX35205	%KX35365	0: disable 1: enable

3) Rev/unit time value is saved at the following special K area.

Class	Device per each channel (Word)								Ref.
	Ch.0	Ch.1	Ch.2	Ch.3	Ch.4	Ch.5	Ch.6	Ch.7	
Rev/unit time	%KD132	%KD137	%KD142	%KD147	%KD1092	%KD1097	%KD1102	%KD1107	-

(b) Count function of Revolution/Unit time is used to count the number of pulses for a specified time while auxiliary mode enable signal is On so that the number of revolution per unit time is calculated as follow.

$$\text{Input pulse} \left(\frac{\text{pls}}{\text{sec}} \right) \times \frac{\text{unit time}(\text{ms}) \times \frac{1}{1000}}{\text{number of pulses per a revolution}(\text{pls})} = \text{Revolution/Unit time}$$

(c) Number of Revolution per 1 second is indicated after number of pulse per 1 revolution is set and time is set to 1 second (1000ms). In order to indicate by Revolutions per minute (RPM), set the Unit time to 1 minute(60,000ms).

(d) In case of that number of pulse per 1 revolution set to '10', the example of calculating Revolution/Unit time is as shown below.

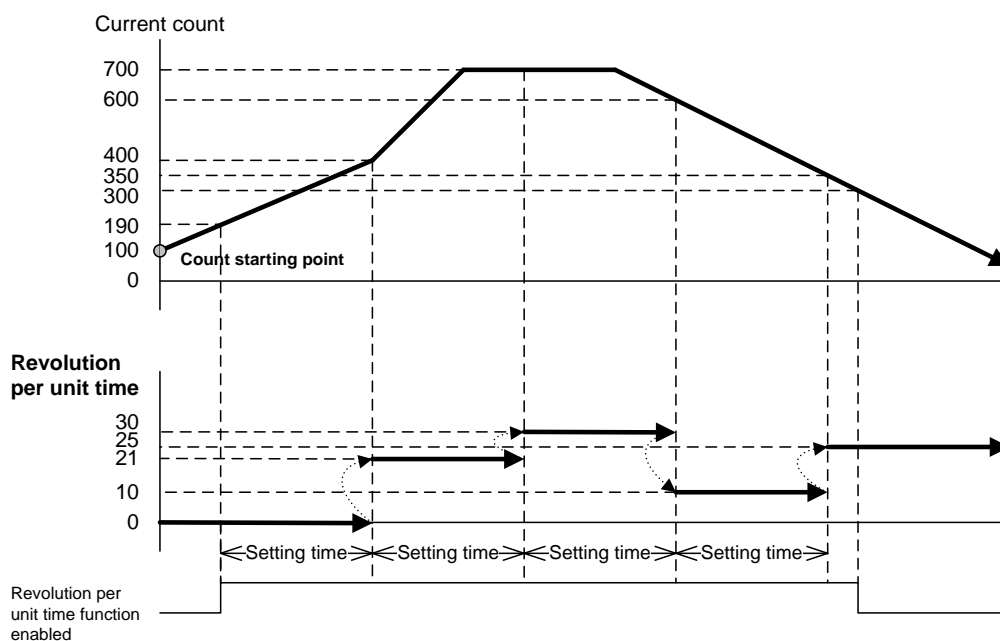

(7) Latch counter function

Latch counter function latches the current counter value when the power is turned off in case of that latch counter enable signal is On.

- Setting: If present counter value is to latch, set Count Latch Enable flag to On.

Class	Device area per channel								Operation
	Ch.0	Ch.1	Ch.2	Ch.3	Ch.4	Ch.5	Ch.6	Ch.7	
Count latch command	%KX41 66	%KX43 26	%KX44 86	%KX46 46	%KX34 886	%KX35 046	%KX35 206	%KX35 366	0: disable 1: enable

- Count latch function is operated when Count latch signal is On. Namely, counter value is not cleared when power supply Off =>On and mode change, it is counted from previous value.
- In latch counter function, internal or external preset function has to use for clearing present value.

(8) Preset function

It changes the current value into preset value.

There are two types of preset function, internal preset and external preset. External preset is fixed as input contact point of main unit(P0008~P000F).

Parameter	CH 0	CH 1	CH 2	CH 3
<input type="checkbox"/> Counter mode	Linear	Linear	Linear	Linear
<input type="checkbox"/> Pulse input mode	1-Phs 1-In x1	1-Phs 1-In x1	1-Phs 1-In x1	1-Phs 1-In x1
Internal preset	100	0	0	0
External preset	200	0	0	0
Ring Counter Min. Value	0	0	0	0
Ring Counter Max. Value	0	0	0	0
<input type="checkbox"/> Comp0 output mode	(Magnitude)<	(Magnitude)<	(Magnitude)<	(Magnitude)<
<input type="checkbox"/> Comp1 output mode	(Magnitude)<	(Magnitude)<	(Magnitude)<	(Magnitude)<
Comparator Output0 Min.Value	0	0	0	0
Comparator Output0 Max.Value	0	0	0	0
Comparator Output1 Min.Value	0	0	0	0
Comparator Output1 Max.Value	0	0	0	0
<input type="checkbox"/> Comp0 output point	No use	No use	No use	No use
<input type="checkbox"/> Comp1 output point	No use	No use	No use	No use
Unit time [ms]	1	1	1	1
Pulse/Rev value	1	1	1	1
<input type="checkbox"/> Freq. Measure	1 Hz	1 Hz	1 Hz	1 Hz

-2147483648~2147483647

OK Cancel

- Preset setting value is saved at the following special K area.

Type	Area per each channel (Double word)								Ref.
	Ch.0	Ch.1	Ch.2	Ch.3	Ch.4	Ch.5	Ch.6	Ch.7	
Internal preset value	%KD152	%KD167	%KD182	%KD197	%KD1112	%KD1127	%KD1142	%KD1157	-
External preset value	%KD153	%KD168	%KD183	%KD198	%KD1113	%KD1128	%KD1143	%KD1158	-

- Preset command is specified through the following special K area, external preset is used by executing the designated input contact point after allowance bit is on.

Type	Area per each channel (Bit)								Ref.
	Ch.0	Ch.1	Ch.2	Ch.3	Ch.4	Ch.5	Ch.6	Ch.7	
Internal preset command	%KX4161	%KX4321	%KX4481	%KX4641	%KX34881	%KX35041	%KX35201	%KX35361	-
External preset allowance	%KX4162	%KX4322	%KX4482	%KX4642	%KX34882	%KX35042	%KX35202	%KX35362	-
External preset command	%IX0.0.8	%IX0.0.9	%IX0.0.10	%IX0.0.11	%IX0.0.12	%IX0.0.13	%IX0.0.14	%IX0.0.15	-

- External preset is executed in case of that rising edge of external preset input contact is occurred when external preset allowance is enabled.

(9) Frequency measurement function

The function measures and displays the frequency for every measurement cycle when frequency measurement enable flag is On.

(a) Setting

1) Set up Frequency Measure mode.

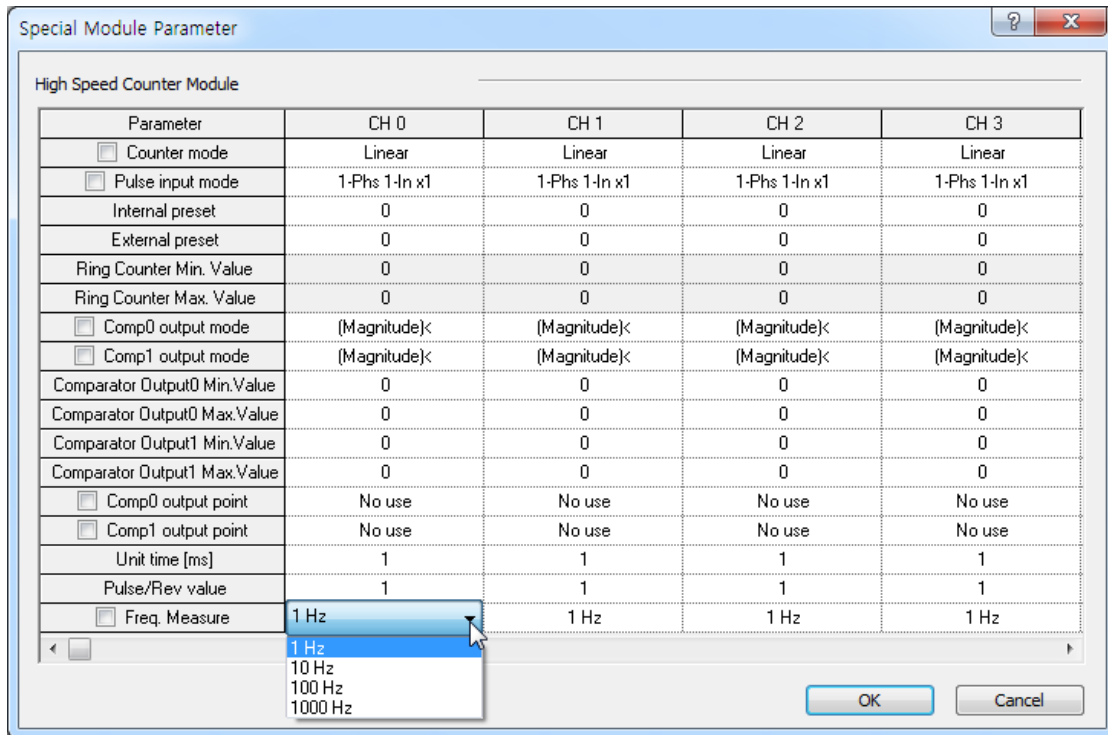

Setting value is saved at the following special K area and user can designate directly.

Class	Device per each channel (Word)								Operation
	Ch.0	Ch.1	Ch.2	Ch.3	Ch.4	Ch.5	Ch.6	Ch.7	
Frequency Measuring Period	%KW32 4	%KW35 4	%KW38 4	%KW41 4	%KW22 44	%KW22 74	%KW23 04	%KW23 34	1, 10, 100, 1000 Hz

2) Set Frequency measurement enable flag to 'Enable' when using frequency measurement function.

Class	Device per each channel (Word)								Operation
	Ch.0	Ch.1	Ch.2	Ch.3	Ch.4	Ch.5	Ch.6	Ch.7	
Frequency measurement enable command	%KX416 8	%KX4328	%KX4488	%KX4648	%KX3488 8	%KX3504 8	%KX3520 8	%KX3536 8	0: disable 1: enable

3) Frequency measurement value is saved at the following special K area.

Class	Device per each channel (Word)								Ref.
	Ch.0	Ch.1	Ch.2	Ch.3	Ch.4	Ch.5	Ch.6	Ch.7	
Frequency measurement value	%KD134	%KD139	%KD144	%KD149	%KD1094	%KD1099	%KD1104	%KD1109	-

- 4) Frequency input mode can be specified as below, whose update cycle and resolution will be decided based on the applicable mode.

Frequency unit setting	Unit[Hz]	Updated cycle[ms]
0	1	1000
1	10	100
2	100	10
3	1000	1

- 5) In case of setting up the frequency unit to 1Hz, the operation of frequency measurement function is as show below.

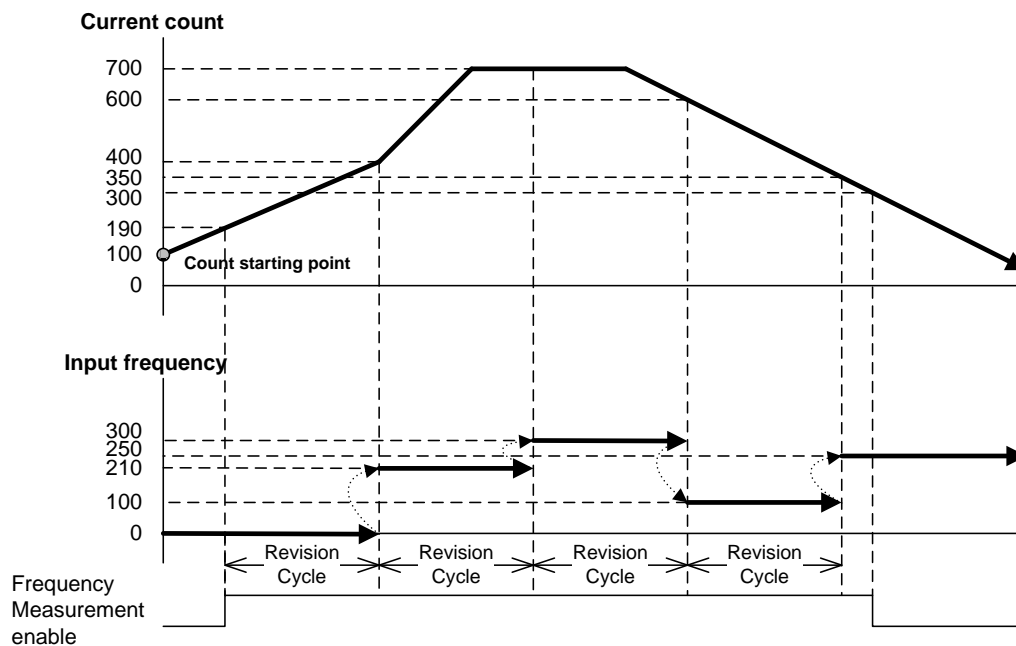

(10) Count pause

Count operation is not executed even if pulses are input when count pause flag is On.

Set the count pause signal to On when using count pause function.

Class	Device area per channel								Operation
	Ch.0	Ch.1	Ch.2	Ch.3	Ch.4	Ch.5	Ch.6	Ch.7	
Count pause	%KX4170	%KX4330	%KX4490	%KX4650	%KX34890	%KX35050	%KX35210	%KX35370	0: disable 1: enable

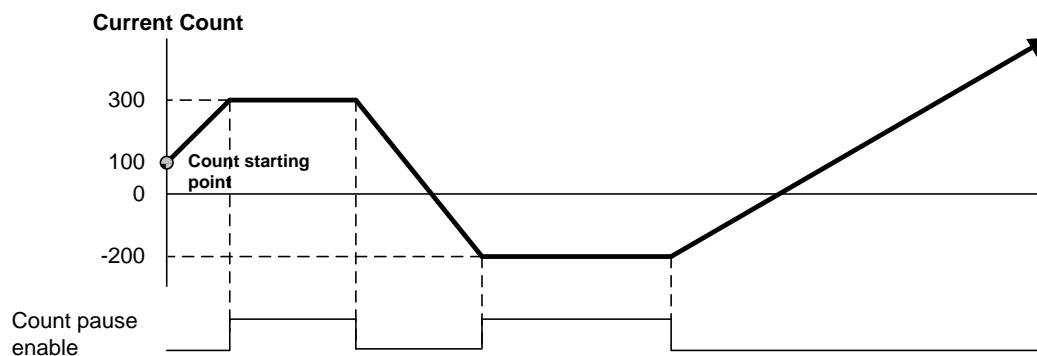

(11) Count clear

When Count clear flag signal is on, present count value is set to 0. The count clear function operates at the rising edge of the flag enable command.

Class	Device area per channel								Operation
	Ch.0	Ch.1	Ch.2	Ch.3	Ch.4	Ch.5	Ch.6	Ch.7	
Count pause	%KX4169	%KX4329	%KX4489	%KX4649	%KX34889	%KX35049	%KX35209	%KX35369	

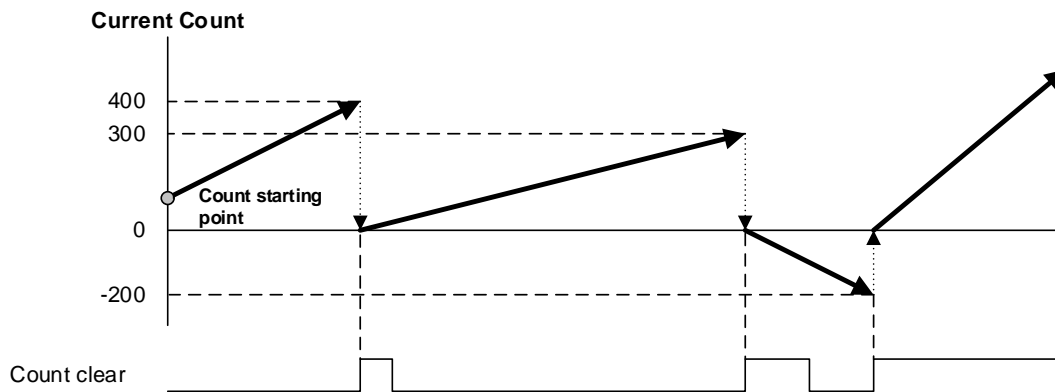

4.2 Installation and Wiring

4.2.1 Precaution for Wiring

Pay attention to the counteractions against wiring noise especially for high-speed counter input.

- (1) Make sure of using separate cables for the power line and external I/O signal line of high-speed counter module so that it is not affected from surge or induced noise from power line.
- (2) The wire has to be selected by considering the permitted current and the ambient temperature.
- (3) If the wire is so near with high temperature machines and materials, or is contacted with oil for a long time, it can be short circuit or malfunction.
- (4) Check the polarity before applying external I/O signal to terminal.
- (5) In case of that the high voltage line and the power line are wired at the same time, the induced interruption is caused. So it can be a reason for abnormal operation or malfunction.
- (6) When using pipe for wiring, grounding for pipe is necessary.
- (7) Use shielded twisted pair cable for wiring pulse input to high-speed counter. If it is speculated that there is a noise source for wiring between high-speed counter and connected devices.
- (8) Connect only A-phase in case of 1-phase input.
- (9) Wire with due regard to maximum output length of pulse generator and wiring should be as short as possible.
- (10) Make sure of grounding with class 3 grounding which is dedicated to the PLC.

4.2.2 Example of Wiring

- (1) When pulse generator(encoder) is voltage output.

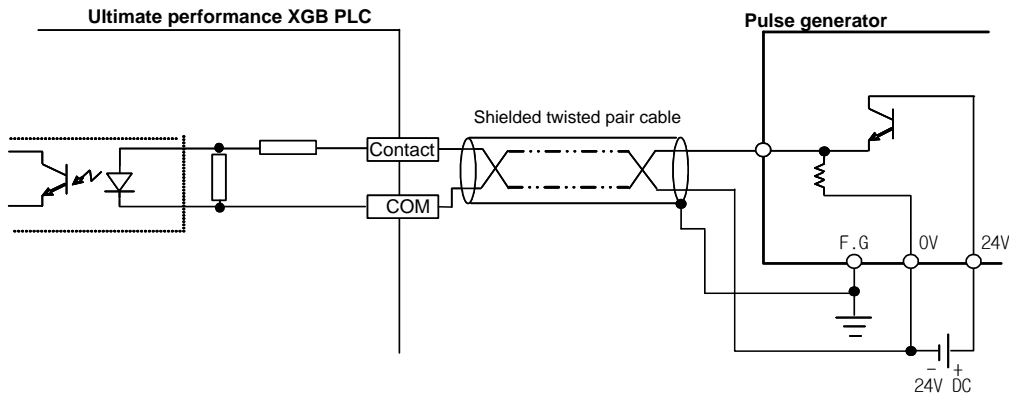

- (2) When pulse generator is open-collector output type.

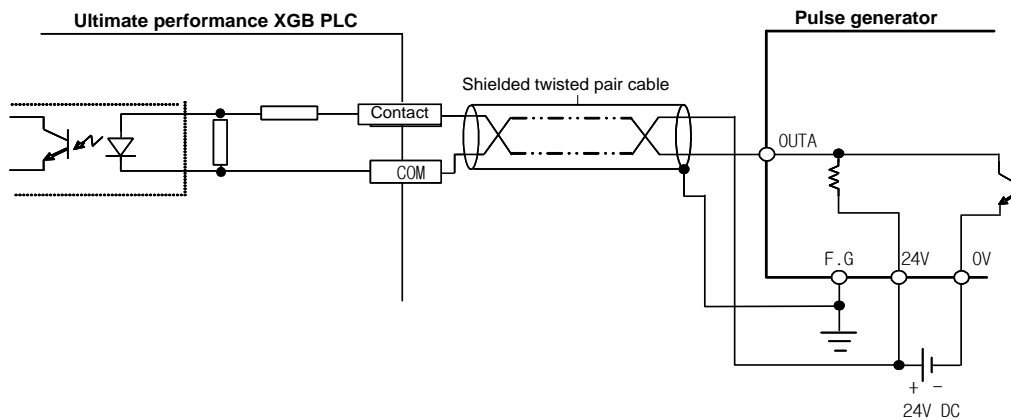

4.3 Internal Memory

4.3.1 Special Area for High-speed Counter

Parameter and operation command area of built-in high-speed counter use special K devices.

If values set in parameter are changed, it works with the changed values.

(1) Parameter setting area

Parameter	Description		Device area per channel				Remark
	Value	Setting	Ch 0	Ch 1	Ch 2	Ch 3	
			Ch 4	Ch 5	Ch 6	Ch 7	
Counter mode	h0000	Linear count	%KW300	%KW330	%KW360	%KW390	Word
	h0001	Ring count	%KW2220	%KW2250	%KW2280	%KW2310	
Pulse input mode setting	h0000	1 phase 1 input 1 multiplication	%KW301	%KW331	%KW361	%KW391	Word
	h0001	1 phase 2 input 1 multiplication					
	h0002	CW / CCW	%KW2221	%KW2251	%KW2281	%KW2311	Word
	h0003	2 phase 4 multiplication					
Comp. Output 0 mode setting	h0000	(Magnitude) <	%KW302	%KW332	%KW362	%KW392	Word
	h0001	(Magnitude) ≤					
	h0002	(Magnitude) =					
	h0003	(Magnitude) ≥	%KW2222	%KW2252	%KW2282	%KW2312	
	h0004	(Magnitude) >					
	h0005	(Range) Include					
h0006	(Range) Exclude						
Comp. Output 1 mode setting	h0000	(Magnitude) <	%KW303	%KW333	%KW363	%KW393	Word
	h0001	(Magnitude) ≤					
	h0002	(Magnitude) =					
	h0003	(Magnitude) ≥	%KW2223	%KW2253	%KW2283	%KW2313	
	h0004	(Magnitude) >					
	h0005	(Range) Include					
h0006	(Range) Exclude						
Internal preset value setting	-2,147,483,648 ~ 2,147,483,647		%KD152	%KD167	%KD182	%KD197	DWord
			%KD1112	%KD1127	%KD1142	%KD1157	
External preset value setting	-2,147,483,648 ~ 2,147,483,647		%KD153	%KD168	%KD183	%KD198	DWord
			%KD1113	%KD1128	%KD1143	%KD1158	
Ring counter min. value setting	-2,147,483,648 ~ 2,147,483,645		%KD154	%KD169	%KD184	%KD199	DWord
			%KD1114	%KD1129	%KD1144	%KD1159	
Ring counter max. value setting	-2,147,483,646 ~ 2,147,483,647		%KD155	%KD170	%KD185	%KD200	DWord
			%KD1115	%KD1130	%KD1145	%KD1160	
Comp. output min. value setting	-2,147,483,648 ~ 2,147,483,647		%KD156	%KD171	%KD186	%KD201	DWord
			%KD1116	%KD1131	%KD1146	%KD1161	
Comp. output max. value setting	-2,147,483,648 ~ 2,147,483,647		%KD157	%KD172	%KD187	%KD202	DWord
			%KD1117	%KD1132	%KD1147	%KD1162	

Chapter 4 Built-in High-speed Counter Function

Parameter	Description		Device area per channel				Remark
	Value	Setting	Ch 0	Ch 1	Ch 2	Ch 3	
			Ch 4	Ch 5	Ch 6	Ch 7	
Comp. output 0 point designation	HFFFF	No use	%KW320	%KW350	%KW380	%KW410	Word
	h0000	P0020					
	h0001	P0021					
	h0002	P0022					
	h0003	P0023					
	h0004	P0024					
	h0005	P0025					
	h0006	P0026					
	h0007	P0027					
	h0008	P0028					
	h0009	P0029					
	h000A	P002A					
	h000B	P002B					
	h000C	P002C					
	h000D	P002D					
	h000E	P002E					
h000F	P002F						
Comp. output 1 point designation	HFFFF	No use	%KW321	%KW351	%KW381	%KW411	Word
	h0000	P0020					
	h0001	P0021					
	h0002	P0022					
	h0003	P0023					
	h0004	P0024					
	h0005	P0025					
	h0006	P0026					
	h0007	P0027					
	h0008	P0028					
	h0009	P0029					
	h000A	P002A					
	h000B	P002B					
	h000C	P002C					
	h000D	P002D					
	h000E	P002E					
h000F	P002F						
Unit time [ms]	1 ~ 60,000 ms		%KW322	%KW352	%KW382	%KW412	Word
			%KW2242	%KW2272	%KW2302	%KW2332	
Pulse/Rev.value	1 ~ 60,000		%KW323	%KW353	%KW383	%KW413	Word
			%KW2243	%KW2273	%KW2303	%KW2333	
Frequency Measurement cycle setting	h0000	1Hz	%KW324	%KW354	%KW384	%KW414	Word
	h0001	10Hz					
	h0002	100Hz	%KW2244	%KW2274	%KW2304	%KW2334	Word
	h0003	1000Hz					

(b) Operation command

Parameter	Device area per channel (Bit)							
	Ch 0	Ch 1	Ch 2	Ch 3	Ch 4	Ch 5	Ch 6	Ch 7
Counter enabling	%KX4160	%KX4320	%KX4480	%KX4640	%KX3488 0	%KX3504 0	%KX3520 0	%KX3536 0
Internal preset designation of counter	%KX4161	%KX4321	%KX4481	%KX4641	%KX3488 1	%KX3504 1	%KX3520 1	%KX3536 1
External preset enabling of counter	%KX4162	%KX4322	%KX4482	%KX4642	%KX3488 2	%KX3504 2	%KX3520 2	%KX3536 2
Designation of decremental counter	%KX4163	%KX4323	%KX4483	%KX4643	%KX3488 3	%KX3504 3	%KX3520 3	%KX3536 3
Comp. output 0 enabling	%KX4164	%KX4324	%KX4484	%KX4644	%KX3488 4	%KX3504 4	%KX3520 4	%KX3536 4
Comp. output 1 enabling	%KX4167	%KX4327	%KX4487	%KX4647	%KX3488 7	%KX3504 7	%KX3520 7	%KX3536 7
Enabling of revolution time per unit time	%KX4165	%KX4325	%KX4485	%KX4645	%KX3488 5	%KX3504 5	%KX3520 5	%KX3536 5
Designation of latch counter	%KX4166	%KX4326	%KX4486	%KX4646	%KX3488 6	%KX3504 6	%KX3520 6	%KX3536 6
Frequency measurement enabling	%KX4168	%KX4328	%KX4488	%KX4648	%KX3488 8	%KX3504 8	%KX3520 8	%KX3536 8
Carry signal (Bit)	%KX4176	%KX4336	%KX4496	%KX4656	%KX3489 6	%KX3505 6	%KX3521 6	%KX3537 6
Borrow signal	%KX4177	%KX4337	%KX4497	%KX4657	%KX3489 7	%KX3505 7	%KX3521 7	%KX3537 7
Comp. output 0 signal	%KX4178	%KX4338	%KX4498	%KX4658	%KX3489 8	%KX3505 8	%KX3521 8	%KX3537 8
Comp. output 1 signal	%KX4179	%KX4339	%KX4499	%KX4659	%KX3489 9	%KX3505 9	%KX3521 9	%KX3537 9

(c) Monitor Area

Parameter	Device area per channel (DWord)							
	Ch 0	Ch 1	Ch 2	Ch 3	Ch 4	Ch 5	Ch 6	Ch 7
Current counter value	%KD131	%KD136	%KD141	%KD146	%KD1091	%KD1096	%KD1101	%KD1106
Revolution per unit time	%KD132	%KD137	%KD142	%KD147	%KD1092	%KD1097	%KD1102	%KD1107
Frequency measurement value	%KD134	%KD139	%KD144	%KD149	%KD1094	%KD1099	%KD1104	%KD1109

4.3.2 Error code

It describes errors of the built-in high-speed counter.

- Error occurred is saved in the following area.

Category	Device area per channel								Remark
	Ch0	Ch1	Ch2	Ch3	Ch4	Ch5	Ch6	Ch7	
Error code	%KW266	%KW276	%KW286	%KW296	%KW2186	%KW2196	%KW2206	%KW2216	Word

- Error codes and descriptions

Error code (Decimal)	Description
20	Counter type is set out of range
21	Pulse input type is set out of range
22	Requesting #1(3,)channel Run during the operation of #0(2) channel 2 phase * During #0(2) channel 2 phase inputting, using #1(3)channel is not possible.
23	Compared output type setting is set out of range.
25	Internal preset value is set out of counter range
26	External present value is set out of counter range
27	Ring counter setting is set out of range * Note ring counter setting should be 2 and more.
28	Compared output min. value is set out of permissible max. input range
29	Compared output max. value is set out of permissible max. input range
30	Error of Compared output min. value>Compared output max. value
31	Compared output is set out of the default output value
34	Set value of Unit time is out of the range
35	Pulse value per 1 revolution is set out of range
36	Compared output min. value is set out of permissible max. input range (Comp. output 1)
37	Compared output max. value is set out of permissible max. input range (Comp. output 1)
38	Error of Compared output min. value>Compared output max. value (Comp. output 1)
39	Compared output is set out of the default output value (Comp. output 1)
40	Frequency measurement cycle setting error

Remark

If two and more errors occur, the module displays the latest error code.

4.4 Example of Using High-speed Counter

It describes examples of using high-speed counter.

(1) Setting high-speed counter parameter

How to set types of parameters to operate a high-speed counter is described as follows.

(a) Set 『Internal Parameters』 in the basic project window.

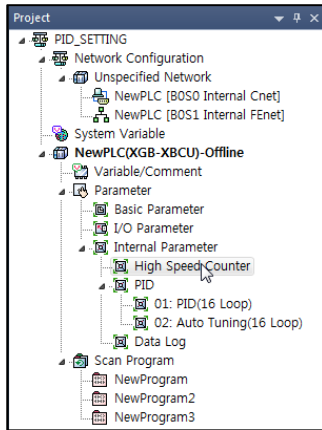

(b) Selecting high-speed counter opens a window to set high-speed counter parameters as follows.

(Every parameter settings are saved in the special K device area.)

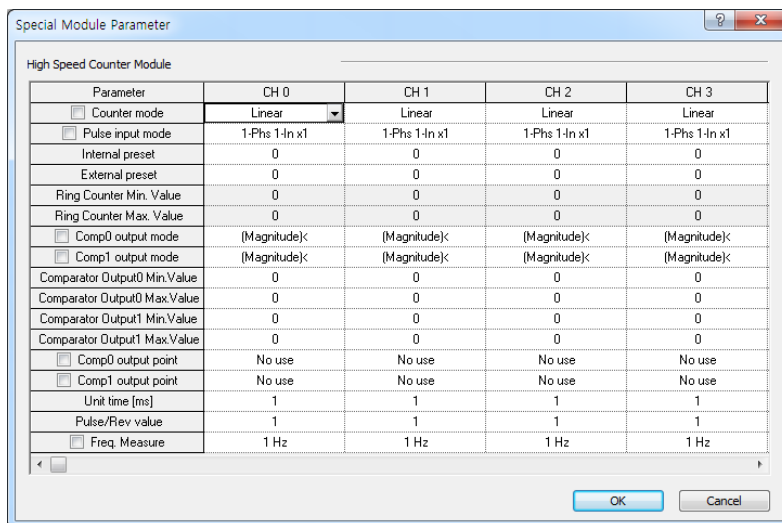

(c) Upon the setting, download program and parameter to PLC.

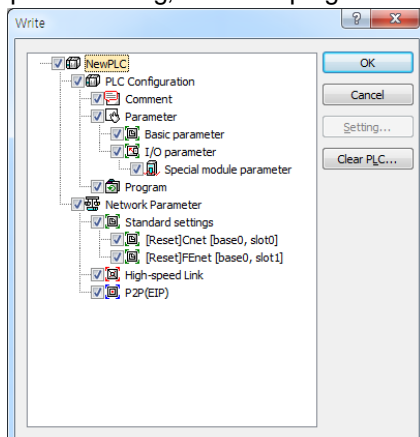

(b) Clicking 『Monitor』 shows monitor and test window of high-speed counter.

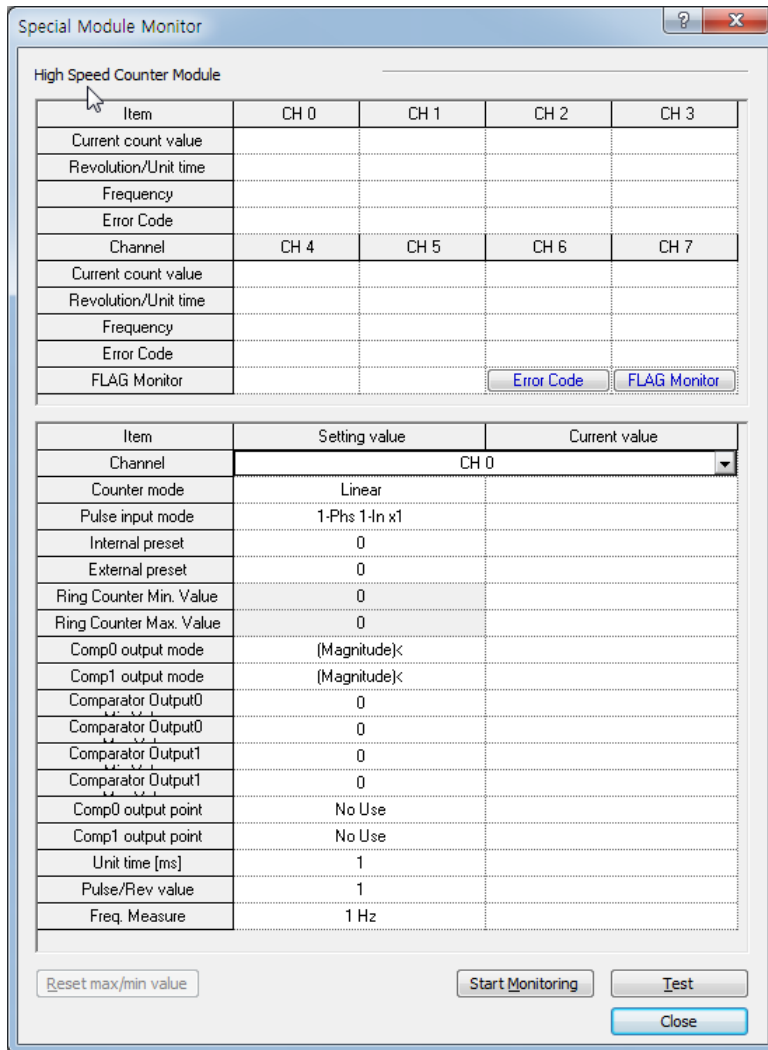

Item	Description
FLAG Monitor	Show flag monitoring and command window of high-speed counter
Start Monitoring	Start monitoring each item (special K device area monitor).
Test	Write each item setting to PLC. (Write the setting to special K device)
Close	Close monitor

(c) Clicking 『Start Monitoring』 shows the high-speed counter monitor display, in which you may set each parameter. At this moment, if any, changed values are not saved if power off=> on or mode is changed.

- (d) Clicking 『FLAG Monitor』 shows the monitor of each flag in high-speed counter, in which you may direct operation commands by flags (clicking commands reverse turn).

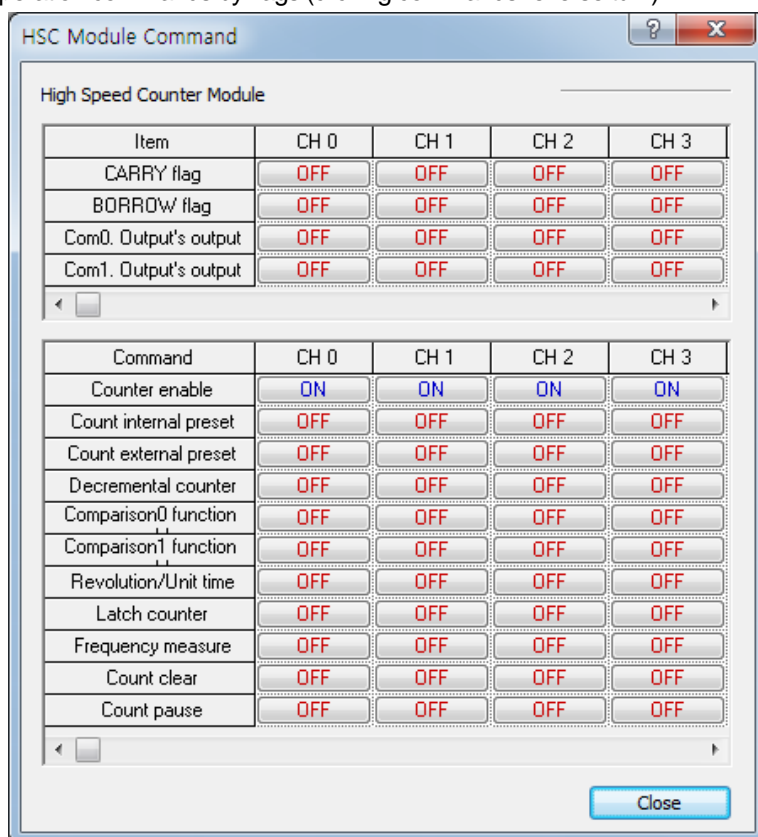

Chapter 5 Data Log Function

5.1 Overview

XGB PLC comes with built-in data log function. This chapter describes the specifications and usage of the data log function.

5.1.1 Features

Using the high-performance XGB internal data log function, you can collect run data of PLC and save them into a SD memory card in the CSV (Comma-Separated Values) format just with a simple parameter configuration. The function has the following features.

(1) Easy PLC Device Data Saving

You can save PLC's various device data with just a simple parameter configuration. It eliminates the need to construct a network to collect large volumes of run data, thereby saving system costs.

In addition, it eliminates problems that might be caused in network-based data collection, such as communication cutoff or cable disconnection.

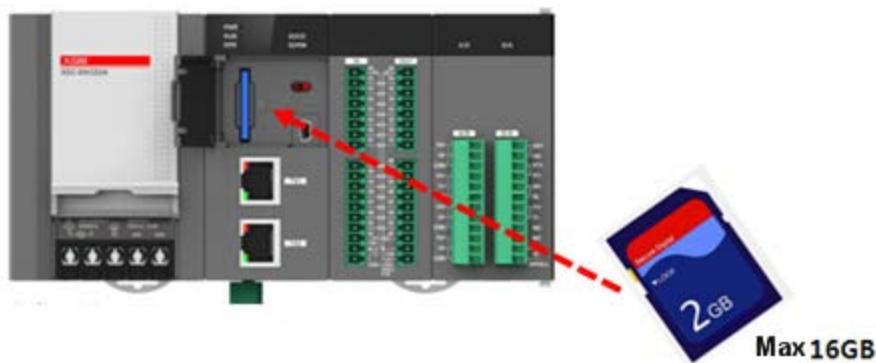

(2) Precise Data Collection

This function allows you to collect precise data for each scan, by 1ms or in accordance with other various run conditions.

In addition, you can use the trigger function to save data before/after the trigger. Or you can use the event function to save data changes from the event occurrence. This allows for easy analysis of the system's run status, which also saves system maintenance costs.

(3) Large-volume Operation Data

The function supports up to 16GB SDHC memory card, which allows for saving run data over a long period of time

(4) FTP Interface

Files saved in the data log can be read remotely using FTP, making it easier to verify data fluctuations.

5.1.2 System Composition

When using the data log function, the system composition is as follows.

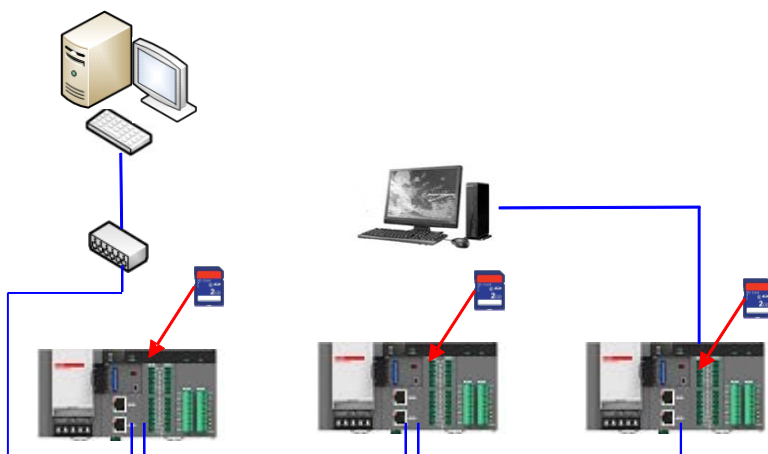

- (1) Enter parameter values using XG5000, then perform data log function.
- (2) Data saved by the PLC is saved into the SD memory in CSV format.
- (3) The saved files can be remotely read through FTP.
- (4) When XG5000 is remotely connected, you can format the SD memory without going through the PC.
(SD memory formatting only supported in PLC STOP)

5.1.3 Part Names

The names of parts related to data log function are as follows.

(1) Part Names

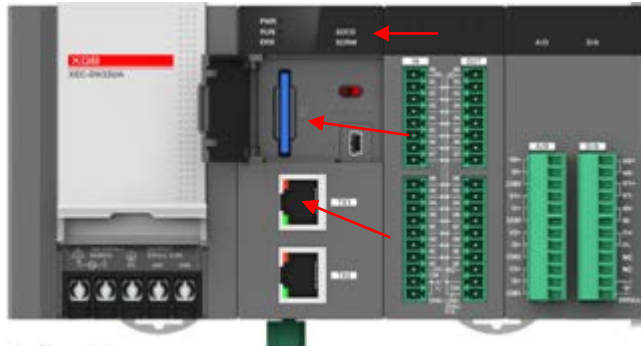

	Names	Description
①	Status LED	Indicates run status of SD memory and data log.
②	SD memory mounting slot	A slot where SD memory is mounted.
③	Internal Ethernet Port	The port is used when transmitting files using the FTP function of the internal Ethernet.

(2) LED Indications



Names	Description	Specifications
RUN	Indicates high-performance XGB PLC run	Turns on during RUN, and turns off at STOP, ERR.
ERR	Indicates high-performance XGB PLC error status	Flashes when error occurs
STATE	Indicates the status of SD memory mounted.	Turns on : SD card mounted, status normal Flashes : SD card mounted, error occurred (flashes at 500ms interval) Turns off: SD card removed
RD/WR	Indicates SD card control status	Flashes : Reading or writing SD card (flashes at 50ms interval) Turns off : Access to SD card terminated

5.1.4 Operation Sequence

Data log is performed in the following sequence.

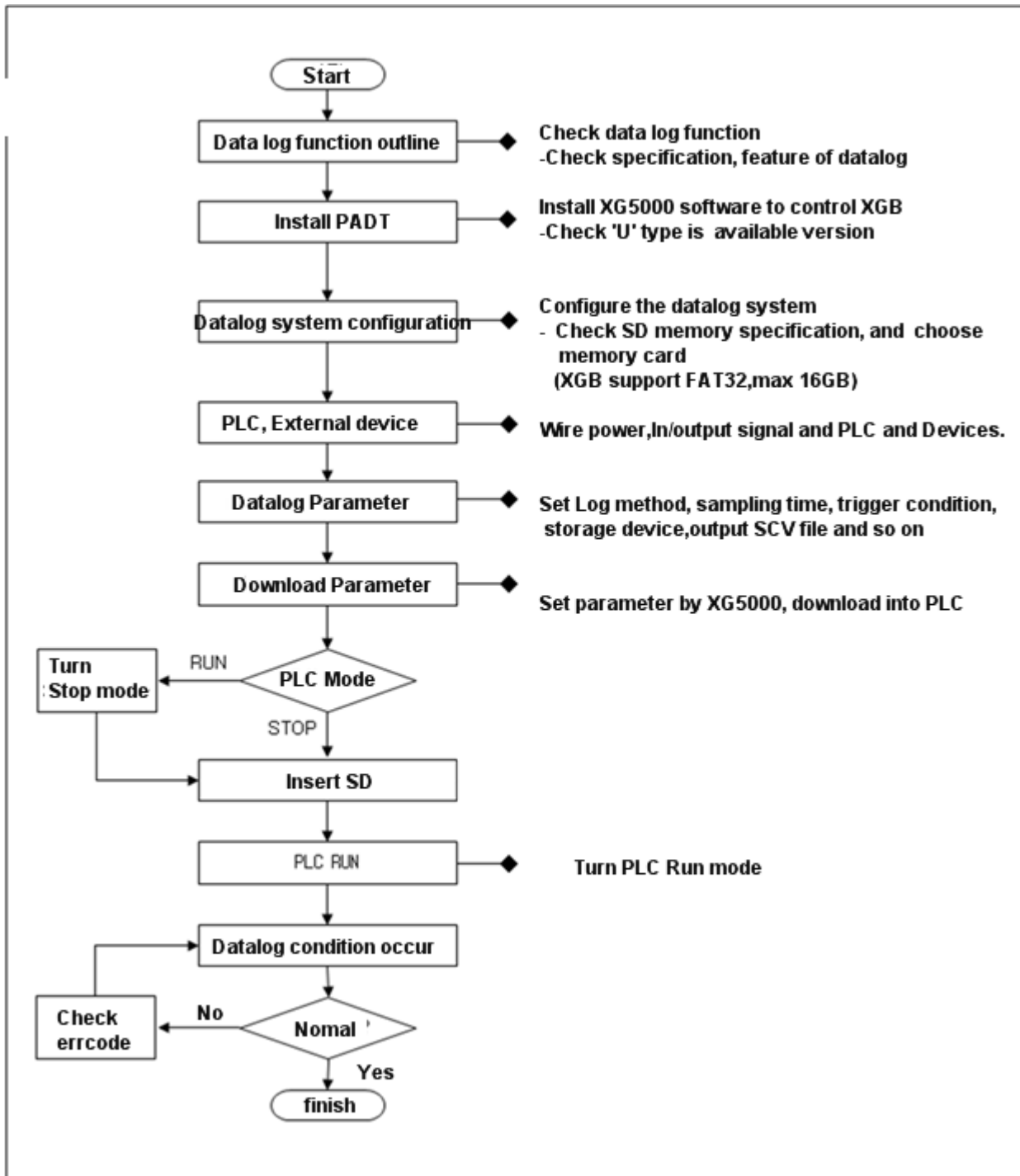

Note

- (1) The SD memory should be formatted in FAT 32 format to be used for high-performance XGB data log function.
- (2) The maximum storage of SD memory supported is 16GB.

5.1.5 Control Signal Flow

The data log function saves the PLC device values into the SD memory or exchanges the value with external device or software, in accordance with the following data flow.

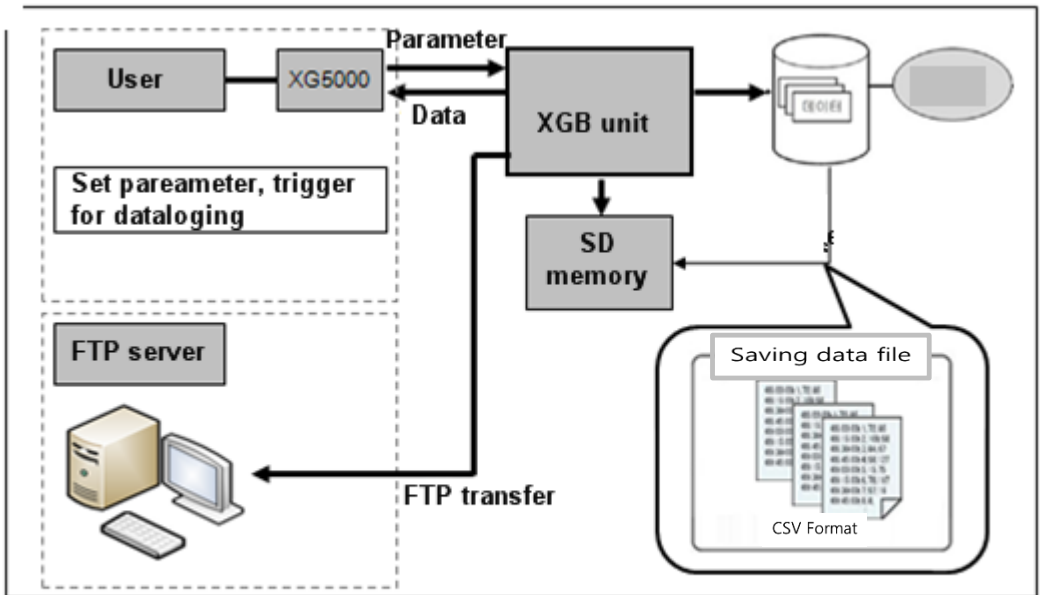

5.2 Performance Specifications

Items		Performance Specifications	Note
Function Configuration	Group Configuration	Up to 10 groups	
	Configuration Data	Up to 32 per group	
	Data Collection Type	regular / trigger / event	
	File Format	CSV	
	File Size	Up to 16MByte	
	Data Type	BIT, BYTE, WORD, DWORD, LWORD, SINT, INT, DINT, LINT USINT, UINT, UDINT, ULINT, REAL, LREAL, STRING	
	Save Data Type	Decimal, Hexadecimal, Exponent, character string	
Regular Save	Sampling Cycle	Scan Cycle, Designation Cycle	
	Sampling Object	32 per file	
	File Conversion	Conversion Timing Designate with File Size 10 ~ 16,384KB Designate with No. of Save Lines 1,000~32,768 개 Maximum No. of Files 256 per folder	
Trigger Save	Single Condition	Bit: elevation/descent Word: small, big, same, different, big or same, small or same	
	Operation Condition	AND, OR condition	
	Trigger Save Range	Up to 8192 data per group	
	Files Conversion	Conversion Timing Designate with File Size 10 ~ 16,384KB Designate with No. of Save Lines 1,000~32,768 개 Maximum No. of Files 256 per folder	
Event Save	Single Condition	Bit: ON, OFF, elevation, descent, transfer Word: small, big, same, different, big or same, small or same	
	Operation Condition	AND, OR condition	
	Files Conversion	Conversion Timing Designate with File Size 10 ~ 16,384KB Designate with No. of Save Lines 1,000~32,768 Maximum No. of Files 256 per folder	
	Formatting Function	Formatting Type Cluster Size Volume Label	Quick Format (PADT formatting recommended) 2G ~ 8G : 4096Byte, 16G : 8192Byte LS (fixed)
SD memory	Power Input	2.7 ~ 3.6VDC	
	Card Size	32mm * 24mm * 2.1mm	
	Maximum Capacity	Up to 16GB	
	Memory Type	SD, SDHC (Recommended manufacturer: SanDisk, Transcend)	
	File System	FAT 32	

Note

- (1) SanDisk, Transcend SD memories are recommended for internal data log. Use of SD memory from other manufacturer may result in unexpected run. Please choose your SD memory card with caution.

5.3 Specific Functions

Data log function refers to storing device values of PLC CPU at a set interval or when the trigger condition occurs. Thus collected data are saved into the SD memory card in CSV format.

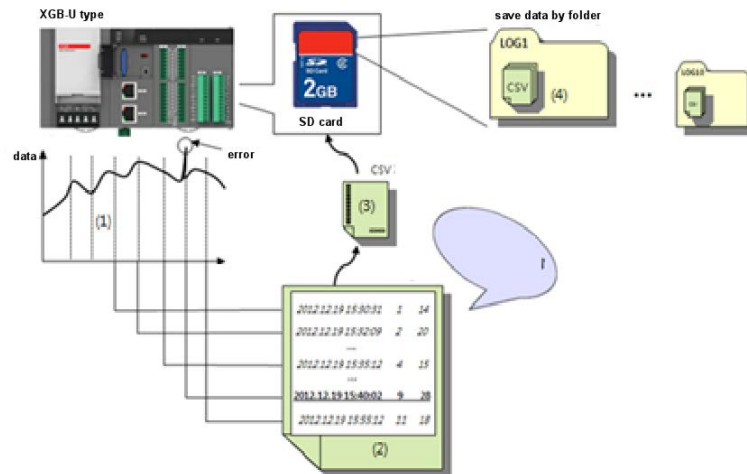

5.3.1 Data Type and Device

You can save device memories using XGB's data log function. When the clock function is normal, the memory is saved along with the time information.

If the clock function is abnormal, the time information is saved as the default value, which is 1984/ 01/01 00:00:00.000.

(1) Data Type

The data types and character strings that can be saved using the internal data log function of high-performance XGB is as follows.

Data Type	Output	Size (including ', ' BYTE)
BIT	0 or 1	2
BYTE	00 ~ FF	3
WORD	0000 ~ FFFF	5
DWORD	00000000 ~ FFFFFFFF	9
LWORD	00000000 00000000 ~ FFFFFFFF FFFFFFFF	17
SINT	-128 ~ 127	5
INT	-32,768 ~ 32,767	7
DINT	-2,147,483,648 ~ 2,147,483,647	12
LINT	-576,460,752,303,423,488 ~ 576,460,752,303,423,487	21
USINT	0 ~ 255	4
UINT	0 ~ 65,535	6
UDINT	0 ~ 4,294,967,295	11
ULINT	0 ~ 1,152,921,504,606,846,975	20

Data Type	Output	Size (including ', ' BYTE)
REAL	-3.402823466e+038 ~ -1.175494351e-038 or 0 or 1.175494351e-038 ~ 3.402823466e+038	17
LREAL	-1.7976931348623157e+308 ~ -2.2250738585072014e-308 or 0 or 2.2250738585072014e-308 ~ 1.7976931348623157e+308	24
STRING	Fixed Character (up to 32 characters)	33

ASCII Code Value	Indication	ASCII Code Value	Indication	ASCII Code Value	Indication	ASCII Code Value	Indication
0x20	SP	0x2A	*	0x3D	=	0x60	`
0x21	!	0x2B	+	0x3E	>	0x61~0x7A	English (lower case)
0x23	#	0x2D	-	0x3F	?	0x7B	{
0x24	\$	0x2E	.	0x41 ~ 0x5A	English (upper case)	0x7C	
0x25	%	0x2F	/	0x5B	[0x7D	}
0x26	&	0x30 ~ 0x39	Number	0x5C	\	0x7E	~
0x27	'	0x3A	:	0x5D]	X	
0x28	(0x3B	;	0x5E	^		
0x29)	0x3C	<	0x5F	_		

(2) Device Available for Saving

The devices that can be used to save files using the internal data log function of high-performance XGB are as follows.

Data Type	Description	Note
BIT	P, M, K, F, T, C, U, L, D, R, N	
WORD	P, M, K, F, T(current value, set value), C(current value, set value), U, Z, L, D, R, N	

(3) Calculates data unit when saving buffer

The basic unit for data saving supported by internal data log is WORD. Therefore, operation of data that accumulates inside the buffer during data collection is performed as follows.

(Unit: WORD)

Type	Calculation Unit
BOOL	1
BYTE	1
WORD	1
DWORD	2
LWORD	4
INT	1
SINT	1
DINT	2
LINT	4
UINT	1
USINT	1
UDINT	2
ULINT	4
REAL	2
LREAL	4
STRING	16

(4) Data Conversion

Data are collected in the following order, and converted into the set types.

1) 2 WORD Data (DWORD, DINT, UDINT, REAL)

Ex) M0000: 0x1234, M0001: Converts to 0x0000 → 0000 1234

Sequence	#2	#1
Device	M0001	M0000

2) 2 WORD Data (LWORD, LINT, ULINT, LREAL)

Ex) M0000: 0x1234, M0001:0x5678, M0002:0x000, M0003: Converts to 0x000 → 0000 0000 5678 1234

Sequence	#4	#3	#2	#1
Device	M0003	M0002	M0001	M0000

3) Character String Conversion

- Unlike other types, character strings are saved up to 32 characters, and converted into 2 characters per word.

If a 0x0000 value exists during conversion, conversion is performed up to that character string, and further conversion is not performed.

Ex) 16 words without 0x000 → 32 characters

16 words with 0x000 → character string converted up to 0x0000

- When converting character strings, characters which do not correspond with ASCII (see 5.3.1) are all converted to NULL.

Sequence	#16	#15	#14	...	#1
Device	M0015	M0014	M0013	...	M0000

Note

If the data are saved using the LINT type, the following may not be represented when verifying the data through Excel.

Actual save data

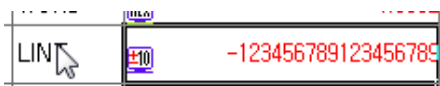

Data verified through Excel

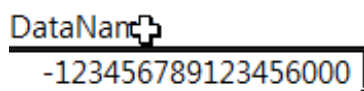

In such cases, you can view the normal data by reading the data using Word Pad.

Note

Float conversion, such as REAL type, supports IEEE754 standards as follows.

BIT 31		BIT 0
Sign (S)	Exponent (E)	Fixed Decimal Point (F)

Sign (S): 1 BIT

Exponent (E): 8 BIT

Fixed Decimal Point (F): 23 BIT

Conversion Value: $(-1)^S \times (1 + F \times 2^{-23}) \times 2^{(E-127)}$

$0 < \text{Exponent (E)} < 255 \rightarrow \text{integer}$

Exponent (E) = 0, Fixed Decimal Point (F) = 0 \rightarrow 0 (ZERO)

Exponent (E) = 0, Fixed Decimal Point (F) > 0 \rightarrow Conversion value close to 0

Exponent (E) = 255, Fixed Decimal Point (F) = 0 \rightarrow INFINITY

Exponent (E) = 255, Fixed Decimal Point (F) > 0 \rightarrow NAN

Note

In case of REAL, LREAL types, -NaN, +NaN are saved for undefined data, and -INF, +INF character strings are saved for data with infinite range.

Please verify the data save range before use.

5.3.2 Data Save Method

The data log function saves data using one of the three methods that follows.

(1) Regular Save

Regular Save refers to saving data at each scan or at a set interval. That is, data at the time of save condition are saved, without considering the status before or after the save condition. This method is useful for collecting certain data at a certain interval.

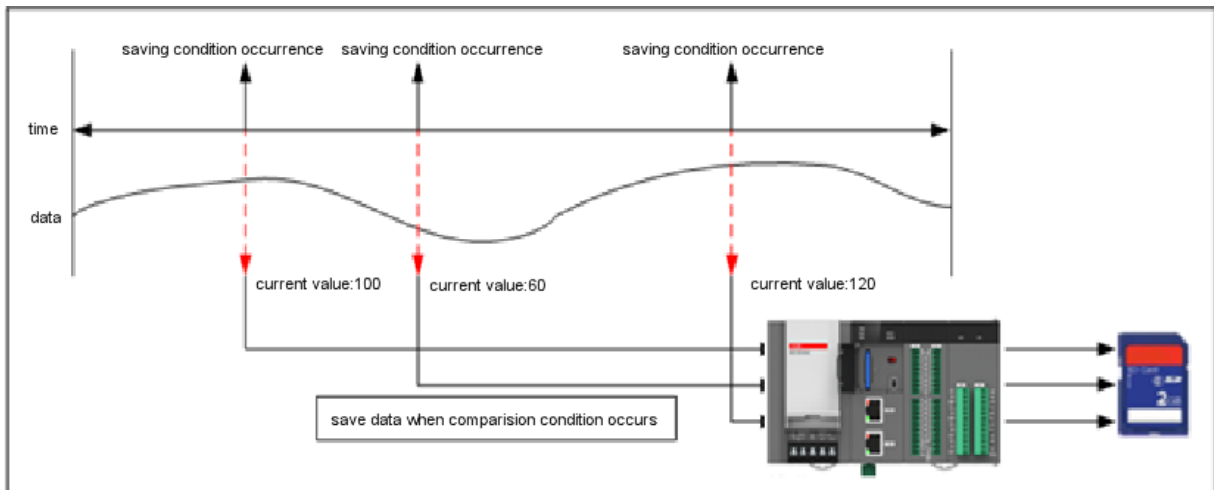

(2) Trigger Save

Trigger Save refers to saving a set number of data before and after the relevant point: the number of data are set by parameter. This method is useful when you want to view data from a certain period before and after a certain event.

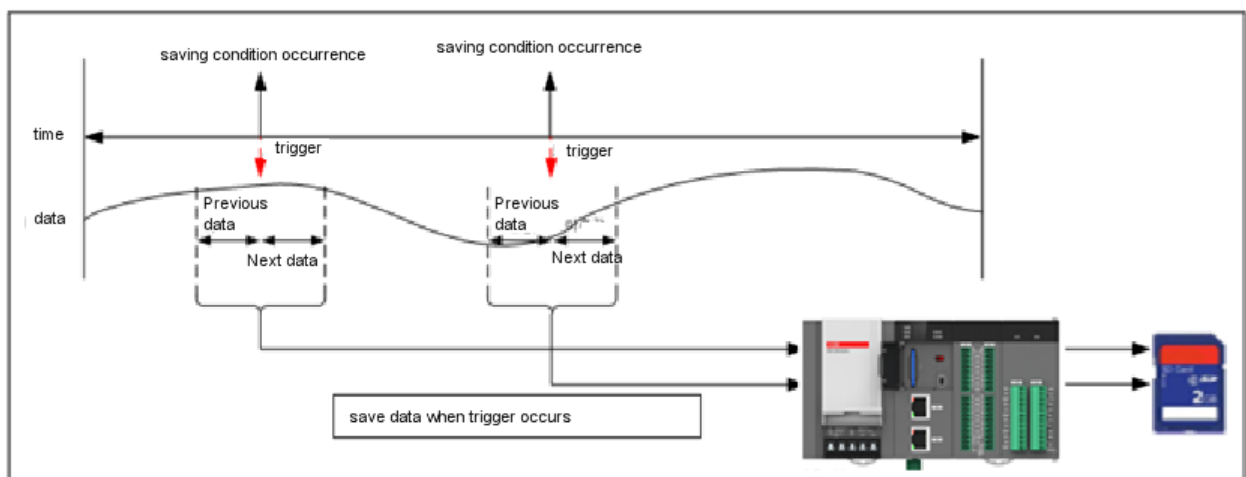

(3) Event Save

Event Save refers to monitoring the device value collected, and saving the the present data when a certain event condition is satisfied. This method is useful for analyzing fluctuation of event values and timing by saving data from the event occurrence to the event termination.

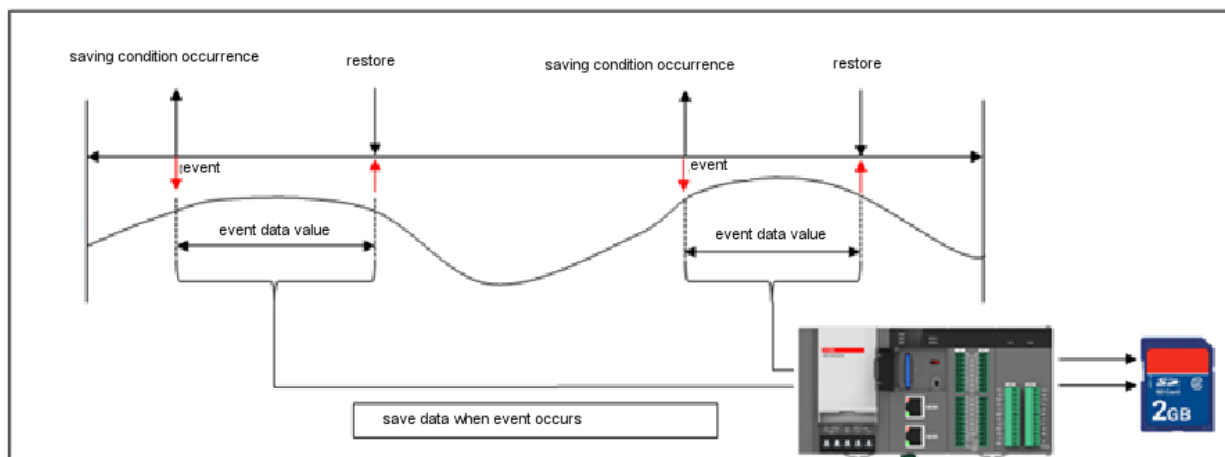

5.3.3 Data Sampling Condition

The data log function classifies the data save conditions and intervals as follows, depending on the parameter setting.

(1) Regular Save

The following are condition setting items for Regular Save.

Setting	Operation	Note
Save at every scan	Data are saved after End of each scan	
Save at certain interval	Data are saved after End of each scan after lapse of set time	

1) Save at every scan

When using the scan interval save method, data are collected after END of each scan. If the volume of stored data is large, a scan watchdog timer error may occur. Please be mindful of the scan watchdog setting of the basic parameter. Collecting data exceeding 4 words/10ms or fast save time may cause data loss.

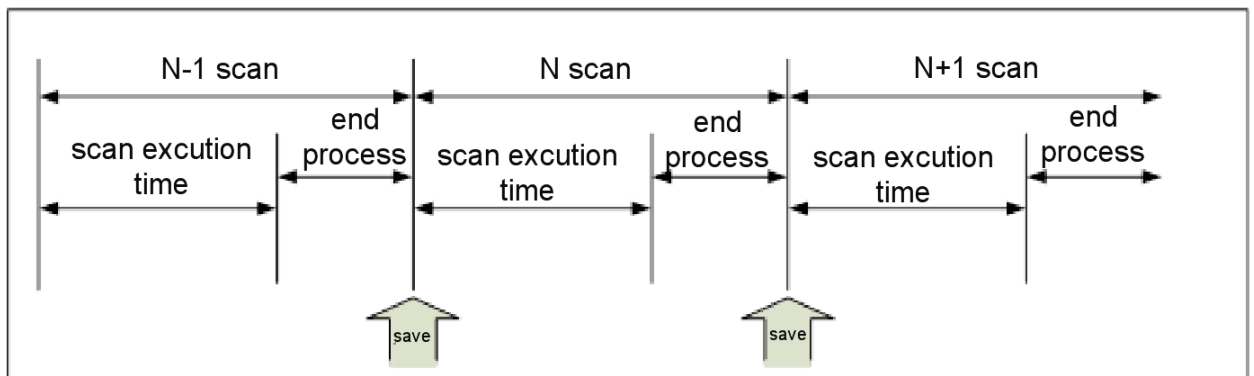

2) Designation Cycle Save





It samples data when a set interval arrives. In the case of sampling data more than 4words/10ms or setup sampling time faster, data loss can be intrigued.

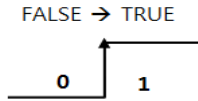
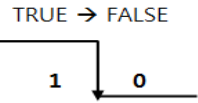
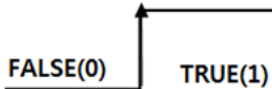

Note

- (1) Although data collection is performed at the interval set by the parameter, file save into the SD memory is performed by scan END.
- (2) Each group has its buffer area, where certain data are collected and then saved into the SD memory.

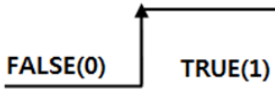
(2) Trigger Save

Save data in the preset number of collection data. The following are condition setting items for Regular Save.

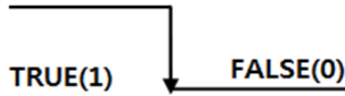
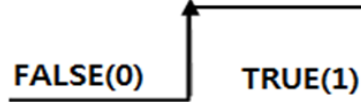
	Trigger Occurrence Condition	Device Set Condition	Operation	Note
BIT Condition	Elevation	X	Saves data at elevation edge of set device bit value 	
	Descent		Saves data at descent edge of set device bit value 	
Word Condition	Elevation	Small	Samples data at the elevation edge when Device Set Condition changes from FALSE(0) to TRUE(1).  Ex) device value >= set value device value = set value device value > set value Ex) device value < set value	
	Descent		Samples data at the descent edge when Device Set Condition changes from TRUE(1) to FALSE(0).  Ex) device value < set value Ex) device value >= set value device value = set value device value <= set value	
	Elevation	Small or Same	Samples data at the descent edge when Device Set Condition changes from FALSE(0) to TRUE(1).  Ex) device value > set value Ex) device value <= set value	
	Descent		Samples data at the descent edge when Device Set Condition changes from TRUE(1) to FLASE(0).  Ex) device value <= set value Ex) device value > set value	

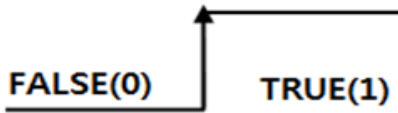
	Elevation	Large	<p>Samples data at the elevation edge when Device Set Condition changes from FALSE(0) to TRUE(1).</p>  <p>Ex) device value <= set value Ex) device value > set value device value = set value device value >= set value</p>	
	Descent		<p>Samples data at the descent edge when Device Set Condition changes from TRUE (1) to FALSE(0).</p>  <p>Ex) device value > set value Ex) device value >= set value</p>	
	Elevation	Large or Same	<p>Samples data at the elevation edge when Device Set Condition changes from FALSE(0) to TRUE(1).</p>  <p>Ex) device value < set value Ex) device value >= set value</p>	
	Descent		<p>Samples data at the descent edge when Device Set Condition changes from TRUE(1) to FALSE(0).</p>  <p>Ex) device value >= set value Ex) device value < set value</p>	
	Elevation	Same	<p>Samples data at the elevation edge when Device Set Condition changes from FALSE(0) to TRUE(1).</p>  <p>Ex) device value ≠ set value Ex) device value = set value</p>	
	Descent		<p>Samples data at the descent edge when Device Set Condition changes from TRUE(1) to FALSE(0).</p>	

Trigger			<p>TRUE(1) FALSE(0)</p> <p>Ex) device value = set value Ex) device value ≠ set value</p>
	Elevation	Different	<p>Samples data at the elevation edge when Device Set Condition changes from FALSE(0) to TRUE(1).</p> <p>FALSE(0) TRUE(1)</p> <p>Ex) device value = set value Ex) device value ≠ set value</p>
	Descent		<p>Samples data at the descent edge when Device Set Condition changes from TRUE(1) to FALSE(0).</p> <p>TRUE(1) FALSE(0)</p> <p>Ex) device value ≠ set value Ex) device value = set value</p>

Trigger condition saves data after END of each scan. In case where a trigger occurs while saving trigger data, the new trigger is ignored.

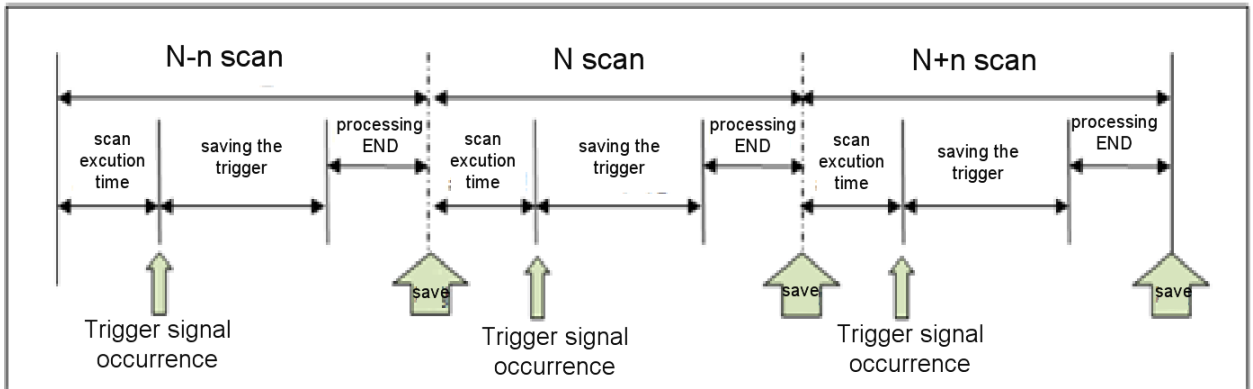

(3) Event Save

Event Save runs with similar conditions to Trigger Save. Event Save refers to saving data when the event occurs, until the conditions are not satisfied.

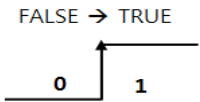
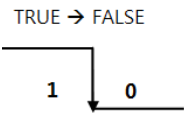
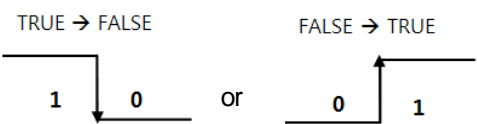
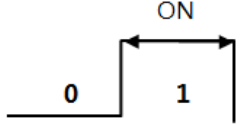
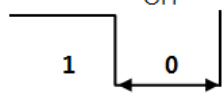
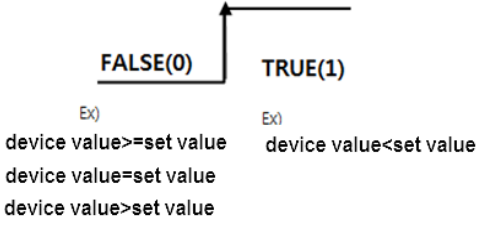
	Event Occurrence Condition	Device Set Condition	Operation	Release Value Setting
BIT Condition	Elevation		Saves data at elevation edge of set device bit value 	
	Descent		Saves data at descent edge of set device bit value 	
	Transfer		Saves data when set device bit value is transferred 	
	ON		Saves data when set device bit value is ON 	
	OFF		Saves data when set device bit value is OFF 	
Word Condition	Elevation	small	Samples data at the elevation edge when Device Set Condition changes from FALSE (0) to TRUE(1). 	Setting Available

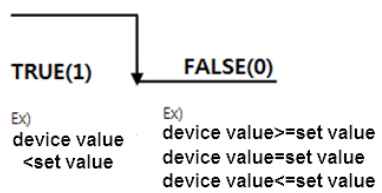
	Descent		Samples data at the descent edge when Device Set Condition changes from TRUE(1) to FALSE(0). 	
	Transfer		Samples data at the elevation edge or descent edge	
	ON		Samples data when Device Set Condition is TRUE(1)	
	OFF		Samples data when Device Set Condition is FALSE(0)	
Word Condition When Event set	Same as Above	Small or Same	Samples data if the condition conversion bit satisfies the set condition when the set word device value is smaller than or the same as the input set value	Setting Available
		Large	Samples data if the condition conversion bit satisfies the set condition when the set word device value is larger than the input set value	Setting Available
		Large or Same	Samples data if the condition conversion bit satisfies the set condition when the set word device value is larger than or the same as the input set value	Setting Available
		Same	Samples data if the condition conversion bit satisfies the set condition when the set word device value is the same as the input set value	Setting Available
			Condition set value	Setting Available

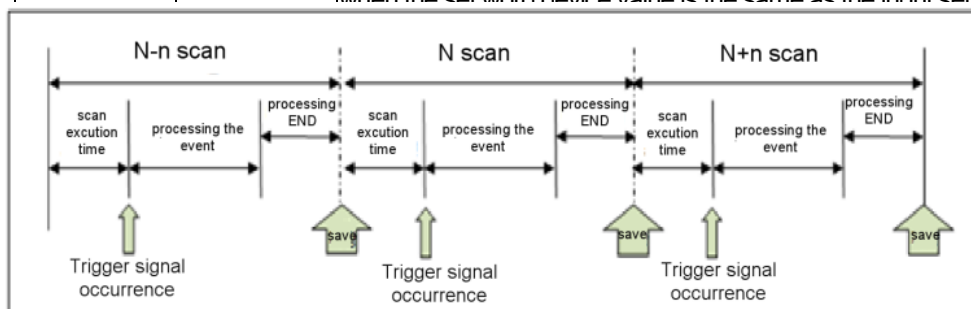

Save method is used, data are saved after END of each scan where the bit condition occurred. Event Save saves

data at each scan after the event occurs. Data loss may occur if the scan interval is faster than the set number of data.

5.3.4 Save Folder Structure

Data saved by data log are saved in the following file structure.

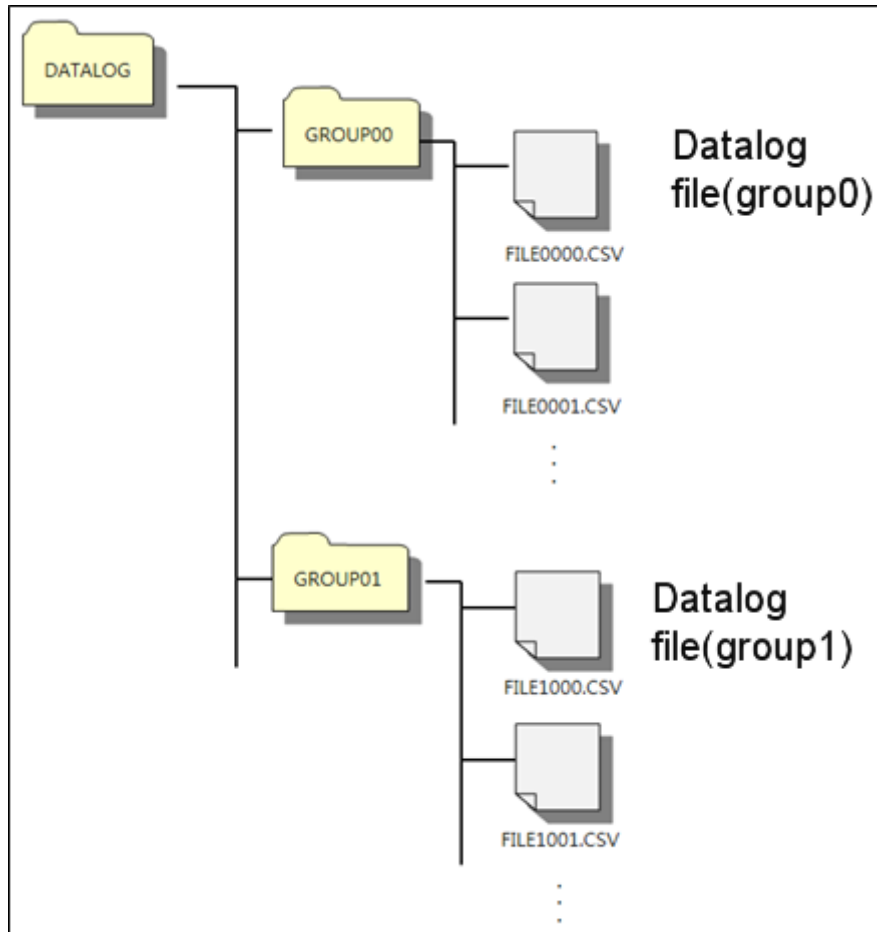

- (1) Folder Name: Folder name is fixed. Creating additional folder other than the structures show in in the Figure below in the SD memory, data log function does not show normal function. Please be careful.
- (2) Data Save Folder: This folder saves log data generated by data log. Each parameter setting group uses different folders. The file names are created in accordance with the following rules. The data folder name can be as long as 8 characters (in case of English, no space). (The folder name indicated in the folder structure diagram is arbitrary. Users can change the names.)

5.3.5 CSV File Format

CSV files generated by data log function follow the following specifications

Items	Description
Separation Character	Comma (,)
Line Change Code	CR, LF(0x0D, 0x0A)
Character Code	ASCII Code
Field Data	Decimal, Hexadecimal, Exponent, character string
File Size	Up to 16Mbyte

	A	B	C	D	E
Header	1 Remark	Project =NewPLC			
	2 Remark	Filename =FILE1001.CSV			
	3 Remark	Start Date =2014/04/14/11:52:50.877			
	4 Remark	PLC Type =XGB-XBCU			
	5 Remark	LogType =Normal			
	6 Remark	DataType INT			
	7				
	8 TIME	INDEX	DataName		
Data File	9 2014/04/14/11:52:50.877	15982	17021		
	10 2014/04/14/11:52:50.887	15983	17022		
	11 2014/04/14/11:52:50.897	15984	17023		

(1) Header File Structure

The header structure of data log files saved in the SD memory is as follows

Remark	Project Name
Remark	Save File Name
Remark	File Creation Time
Remark	PLC Type
Remark	Data Log Save Type
Remark	Data Conversion Type

(2) Data File Structure

The internal structure of data log files saved in the SD memory is as follows

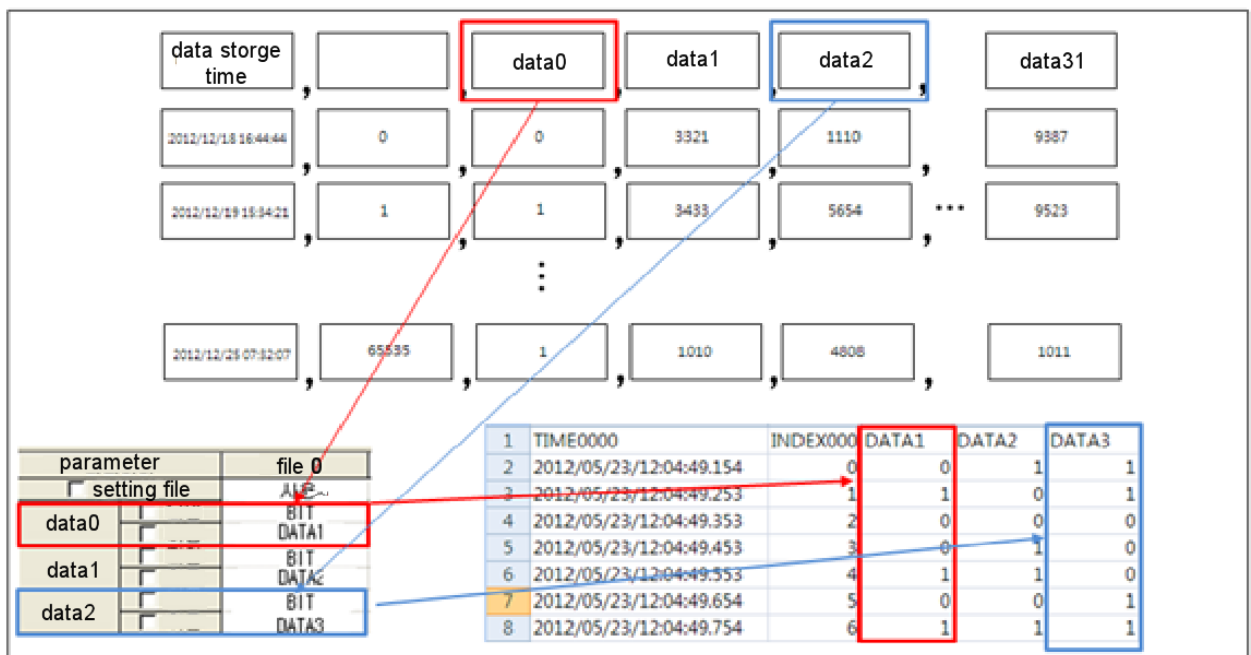
**Note**

- (1) Index indicates the number of saved data
- (2) Data 0, Data 1, ..., Data 31 indicate data names

(3) Data File Item Description

1) First Data Line

String Name	Output	Size (Word)
Temporary String	Indicates date and time with fixed characters	5
Index String	Indicates index name	2
Data String	Outputs the data name designated at data setting	

2) Data Row Repeat

Column Name	Output	Size (Byte)
Date and Time Column	String is output using the data output format set at CSV Output Setting. Ex) 2014/09/17 10:15:20:243	24
Index Column	Outputs counted numbers starting from 0 and up.	10
Data Column	BOOL 0 or 1	2
	BYTE 00 ~ FF	3
	WORD 0000 ~ FFFF	5
	DWORD 00000000 ~ FFFFFFFF	9
	LWORD 00000000 00000000 ~ FFFFFFFF FFFFFFFF	17
	SINT -128 ~ 127	5
	INT -32,768 ~ 32,767	7
	DINT -2,147,483,648 ~ 2,147,483,647	12
	LINT -576,460,752,303,423,488 ~ 576,460,752,303,423,487	21
	USINT 0 ~ 255	4
	UINT 0 ~ 65,535	6
	UDINT 0 ~ 4,294,967,295	11
	ULINT 0 ~ 1,152,921,504,606,846,975	20
	REAL -3.402823466e+038 ~ -1.175494351e-038 or 0 or 1.175494351e-038 ~ 3.402823466e+038	17
LREAL -1.7976931348623157e+308 ~ -2.2250738585072014e-308 or 0 or 2.2250738585072014e-308 ~ 1.7976931348623157e+308	24	
STRING Fixed Character (up to 32 characters)	33	

5.3.6 How to Save CSV Files

High-performance XGB collects data whenever the sampling condition occurs, saves them into the SD memory as CSV files. When the data meet file conversion time, PLC generates a new file in the SD memory card to perform data saving.

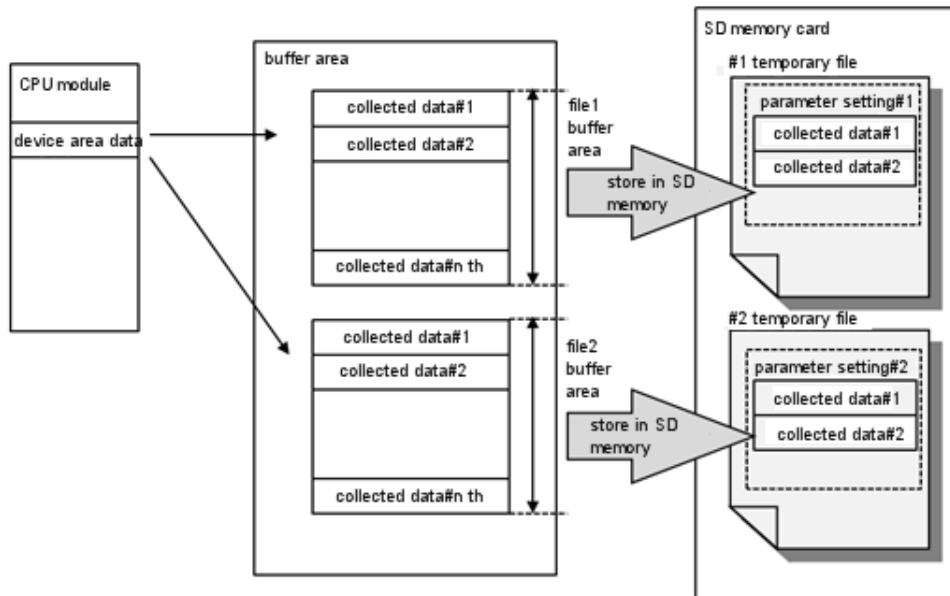

1) File Conversion Test

Temporary files are converted to CSV files at the following points

At saving	Setting Range
When the designated number of saves have been completed in the temporary file	1000 ~ 32768
When the temporary file reaches the designated size	10KB ~ 16,384KB
When the file size exceeds 16,384KB	Automatically converts to CSV files

2) Operation in Case of Exceeding the Number of Save Files

When the number of maximum saved files set by the parameter is exceeded, the following run occurs in accordance with the set runs in case of file excess.

Operation Setting in Case of Excess	Operation	Note
Maintains the latest history	Overwrites and saves new data over the oldest file	
Maintains the initial history	Performs no more file saving	

Note

In case the SD memory is not capable of saving 256 files and the storage is full, the following run occurs in accordance with the [History Setting] value in the parameter.

Maintains the latest history Saves file up to the full storage of SD memory, and continues saving into No. 0 file

Maintains the initial history Saves file up to the full storage of SD memory, then stops data saving

5.3.7 Buffer Memory

High-performance XGB has an internal buffer memory for data log function. Buffer memory refers to a volatile memory which temporarily stores collected data before saving them into the temporary file in the SD memory.

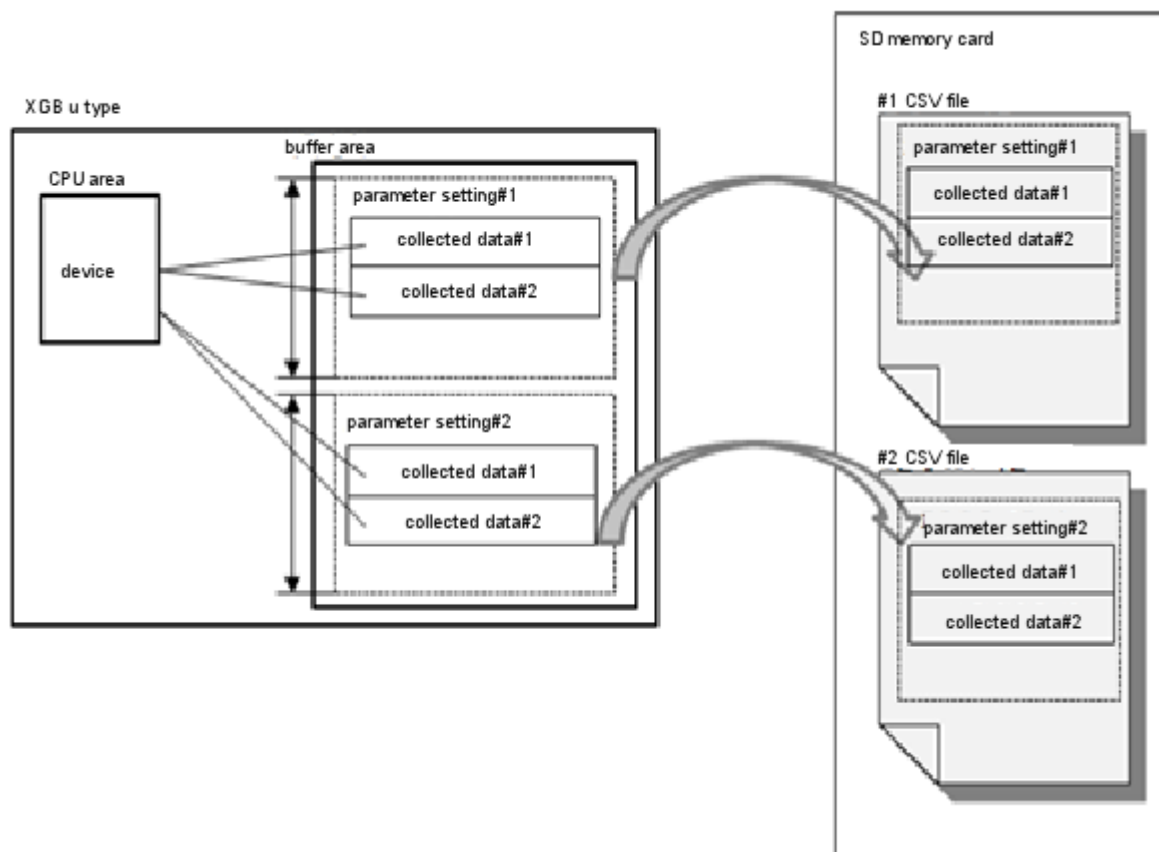

In accordance with the set sampling condition, the collected data are stored in the buffer memory first and then saved in to the temporary memory of the SD memory card when data log condition occurs. Therefore, setting too fast data sampling condition or sampling too much data, data loss can be caused by buffer memory excess. Data loss increases the DATA_CLASH flag counter.

5.3.8 Data Omission

Data omission refers to situation where normal data collection is not possible. If data collection interval is set too short, data sampling might not be performed at every set interval, which in turn might cause data omission. Cases include the following.

(1) Buffer Excess

If data sampling condition is set too fast or too much data are being sampled, the speed of saving buffer memory values into the temporary file in the SD memory may be slower than the data collection speed, which causes the buffer storage to be exceeded and data omission. (5.11 see data processing time)

(2) Too Frequent File Conversion

Upon occurrence of file conversion condition, the temporary file should be converted to CSV file to create a new temporary file. Meanwhile, the buffer memory values cannot be saved into the temporary file. Therefore, too frequent occurrence of file conversion condition may cause the buffer memory storage to be exceeded, and thus leading to data omission.

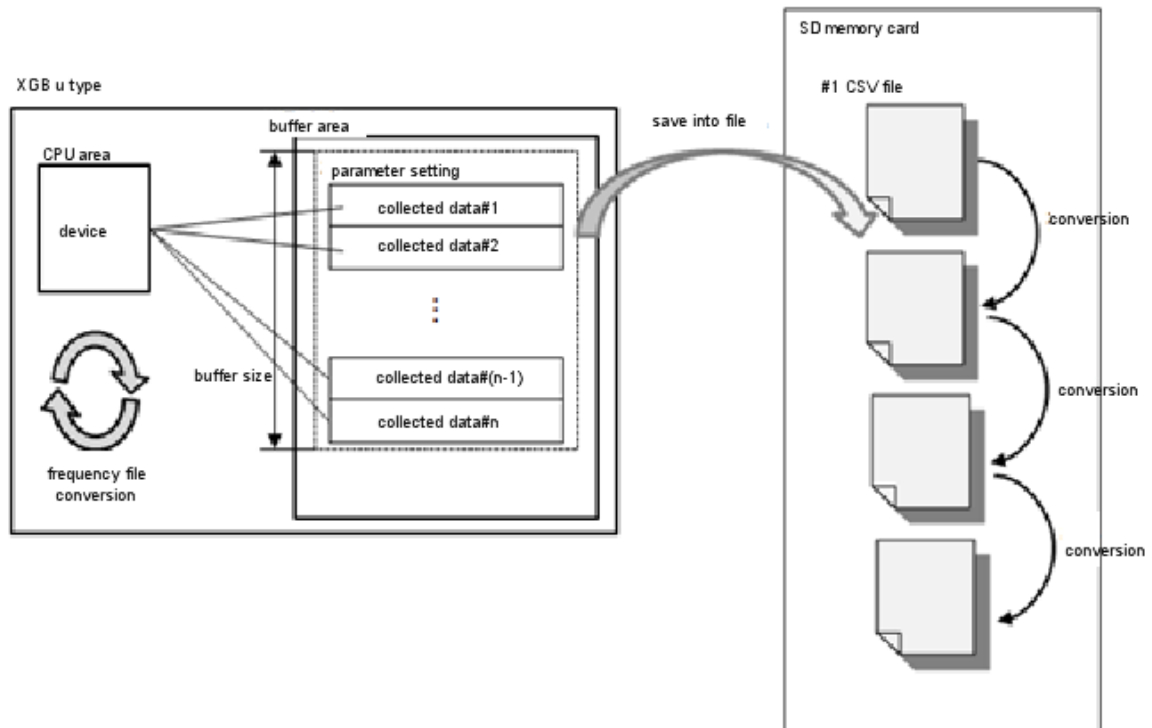

(3) FTP Operation / Web Server Operation

When using Data Log, in case of using FTP and Web Server at same time, please consider the Data Log performance.

5.3.9 Files Backup Cycle

Data collected by data log are not directly saved into the SD memory. They are saved into the designated buffer, and later saved in to the SD memory when a certain volume (4Kbyte) has been collected. When the data save interval is long and the volume of data to collect is not large, it takes a lot of time to save data into the SD memory. If collected data are saved only in the buffer before sudden shutoff or reset occurs, the saved data are all lost.

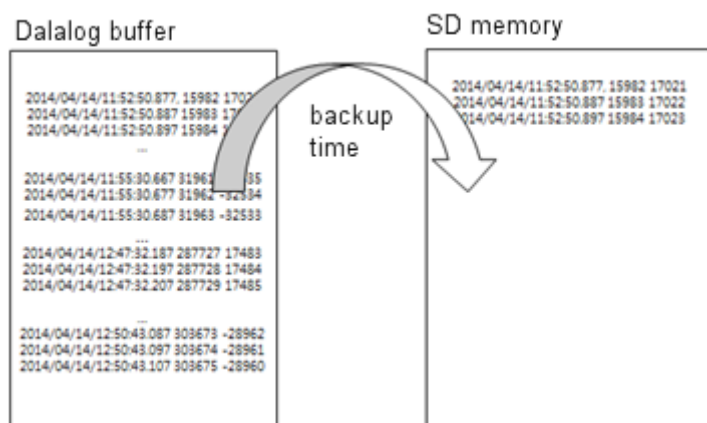

To prevent this, the collected data need to be saved into the data at certain intervals regardless of the storage. The data saved into the SD memory is not lost even in case of sudden power change. Backup time can be set at from 1 to 5 seconds. However, setting too short backup time may affect data log performance.

5.4

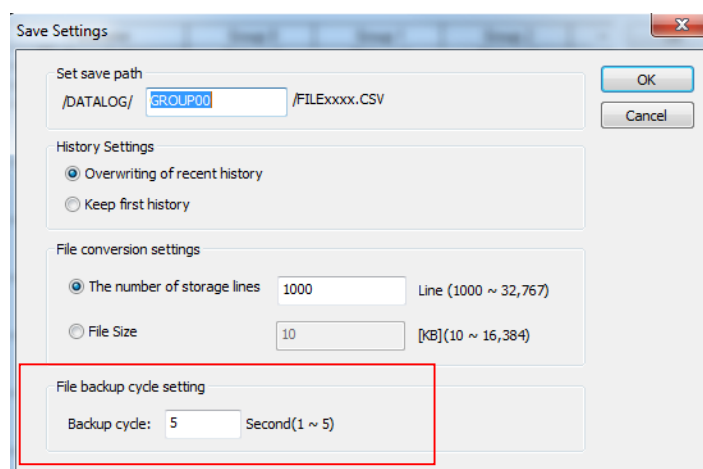

5.4 Regular Save

Among internal data log functions of high-performance XGB, Regular Save runs in two methods: Scan Save and Save at Designated Interval

Scan Saves refer to saving data at each scan, and Save at Designated Interval refers to saving data at an interval set by the user.

5.4.1 Save Method

(1) Operation Description

Among internal data log functions of high-performance XGB, Scan Saves refer to saving data at each scan into the SD memory. When using the scan interval save method, data are saved after END of each scan. The collected data are accumulated in the PLC internal buffer. When a certain amount is accumulated, these are saved into the SD memory. If the set interval is too short or the data to collect is too large, a scan watchdog timer error may occur due to increased data volume. Please be mindful of the scan watchdog setting of the basic parameter.

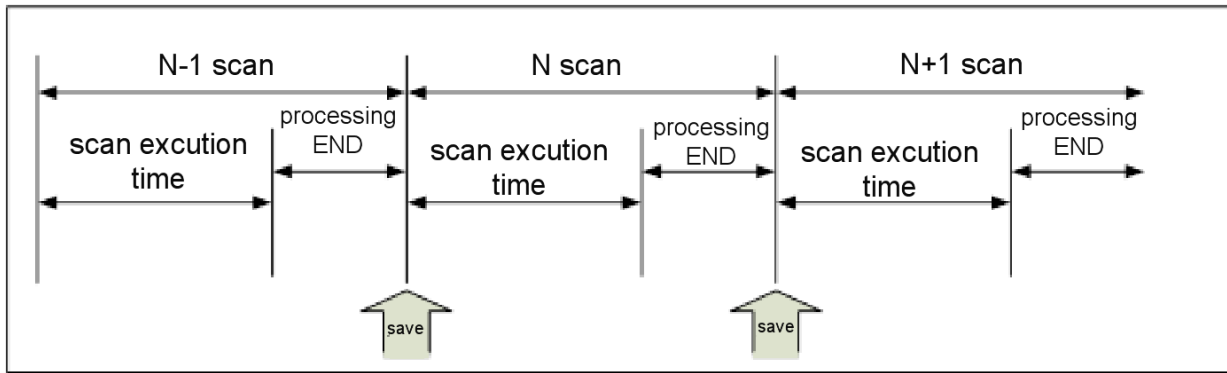

(2) Setting Method

- 1) Choose XG5000 - [Project Window] - [internal parameter] - [data log]

This activates the data log parameter setting window.

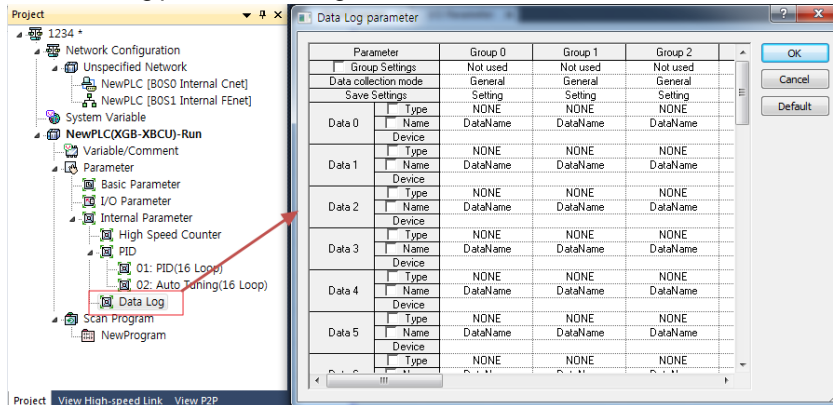

- 2) Set the group to use on the data log parameter window.

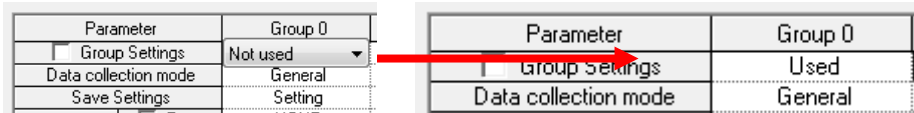

Note

It runs when both the data log parameter and the data log EN flag are set. In case either condition is omitted, the data log run will not progress.

Please verify whether both the data log parameter and the data log EN flag are set. (See 5.10, Flag List)

- 3) Choose [Save at Every Scan] at the [Data Collection Method]

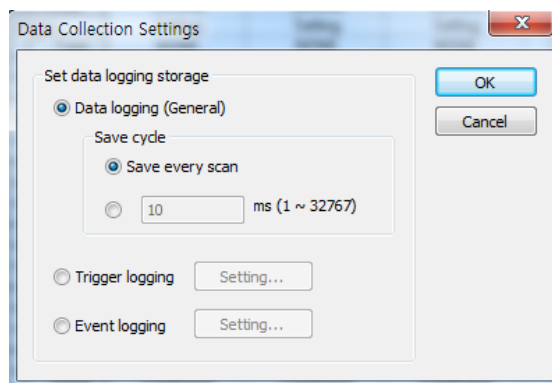

- 4) Set the path, history setting and file conversion point at [Save Setting]

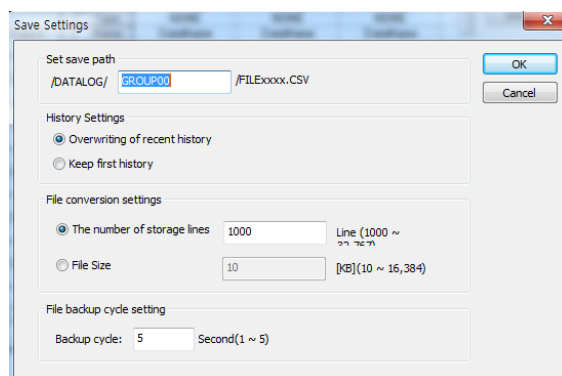

- 5) Set the data conversion type, storage device and name

Data 0	<input type="checkbox"/> Type	NONE
	<input type="checkbox"/> Name	NONE
	<input type="checkbox"/> Device	BIT
Data 1	<input type="checkbox"/> Type	BYTE
	<input type="checkbox"/> Name	WORD
	<input type="checkbox"/> Device	DWORD
Data 2	<input type="checkbox"/> Type	LWORD
	<input type="checkbox"/> Name	SINT
	<input type="checkbox"/> Device	INT
Data 3	<input type="checkbox"/> Type	DINT
	<input type="checkbox"/> Name	LINT
	<input type="checkbox"/> Device	USINT
Data 4	<input type="checkbox"/> Type	UINT
	<input type="checkbox"/> Name	UDINT
	<input type="checkbox"/> Device	ULINT
	<input type="checkbox"/> Type	REAL
	<input type="checkbox"/> Name	LREAL
	<input type="checkbox"/> Device	STRING

Data 0	<input type="checkbox"/> Type	INT
	<input type="checkbox"/> Name	DataName
	<input type="checkbox"/> Device	

- 6) Connect the SD memory card, and turn on the Data Log Enable Flag (K40000) when the DL RDY (K40010) Flag is On to activate the function. Data log will not be activated if the Enable Flag is ON while DL RDY (K40010) Flag is OFF.
- The following are Enable Flags for each data log group

Item	Type	Description
%KW4000	WORD	Data Log Enable Flags
%KX64000	BIT	Group 0 Enable Flag 1: Operation, 0: Stop
%KX64001	BIT	Group 1 Enable Flag 1: Operation, 0: Stop
%KX64002	BIT	Group 2 Enable Flag 1: Operation, 0: Stop
%KX64003	BIT	Group 3 Enable Flag 1: Operation, 0: Stop
%KX64004	BIT	Group 4 Enable Flag 1: Operation, 0: Stop
%KX64005	BIT	Group 5 Enable Flag 1: Operation, 0: Stop
%KX64006	BIT	Group 6 Enable Flag 1: Operation, 0: Stop
%KX64007	BIT	Group 7 Enable Flag 1: Operation, 0: Stop
%KX64008	BIT	Group 8 Enable Flag 1: Operation, 0: Stop
%KX64009	BIT	Group 9 Enable Flag 1: Operation, 0: Stop

OFF the data log Enable Flag (K40000) to stop data saving. When the SD memory still has data to save, the Log Ending (K40201) flag turns ON, and back to OFF once all data are saved.

The data STOP progress can be verified though LOG, STOP Progress flag. When the flag value is 100, it indicates completion of all data save.

Note

When using Scan Save, set the data log parameters by referring to PLC scan.

Setting too much data and too fast interval may cause data loss

- Scan time can be verified from the following menu.

[On-line] – [Diagnosis] – [PLC Information] – [Performance Tab]

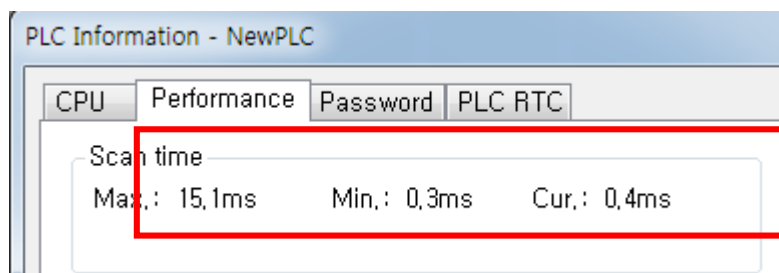

5.4.2 Save at Designated Interval

(1) Description

Save at Designated Interval refers to saving data at intervals set by the user. It is different from Scan Save in that the former collects data at certain intervals, and is capable of saving data that change at certain intervals at more accurate points.

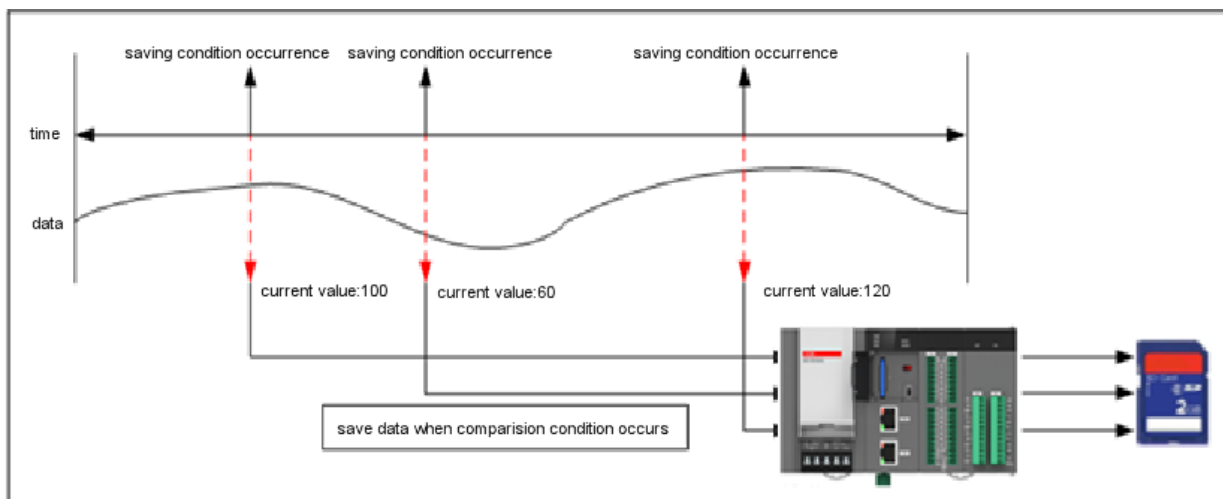

The collected data at each set cycle are scan END processed and saved into the SD memory as a CSV file.

(2) Setting Method

1) Choose XG5000 –[Project Window] - [internal parameter] - [data log]

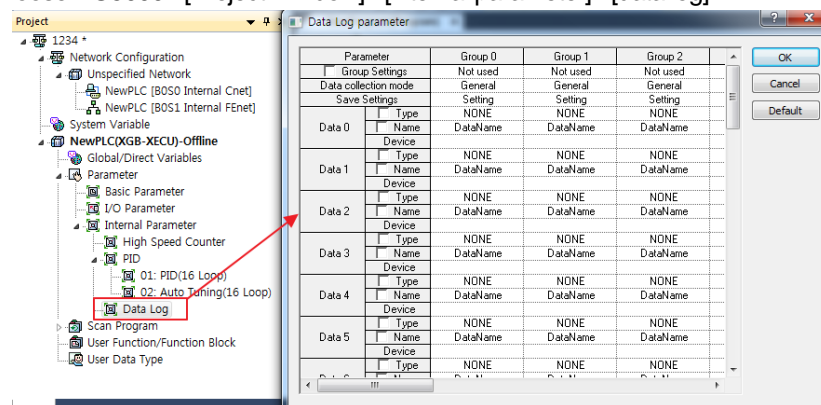

This activates the data log parameter setting window.

2) Set the group to use on the data log parameter window.

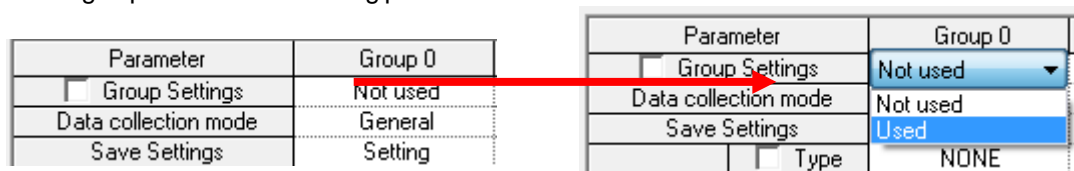

- 1) Set save interval at [Data Collection Method] (Range: 1~32,767ms)

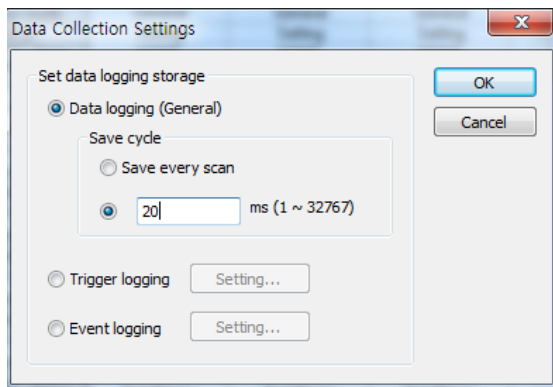

Note

Setting too fast interval (faster than data log save performance) may cause data loss

- ☞ data log: 4 words /10ms
- ☞ data log + FTP(web server): 4 words /20ms
- ☞ data log + FTP +web server: 4 words /30ms

- 2) Set the path, history setting and file conversion point at [Save Setting]

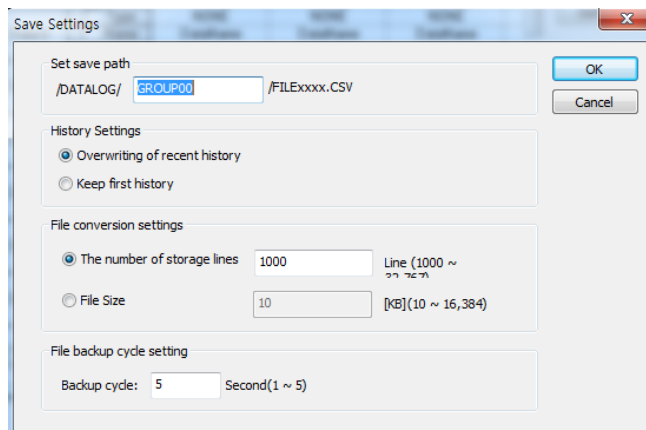

- 3) Set the data conversion type, storage device and name

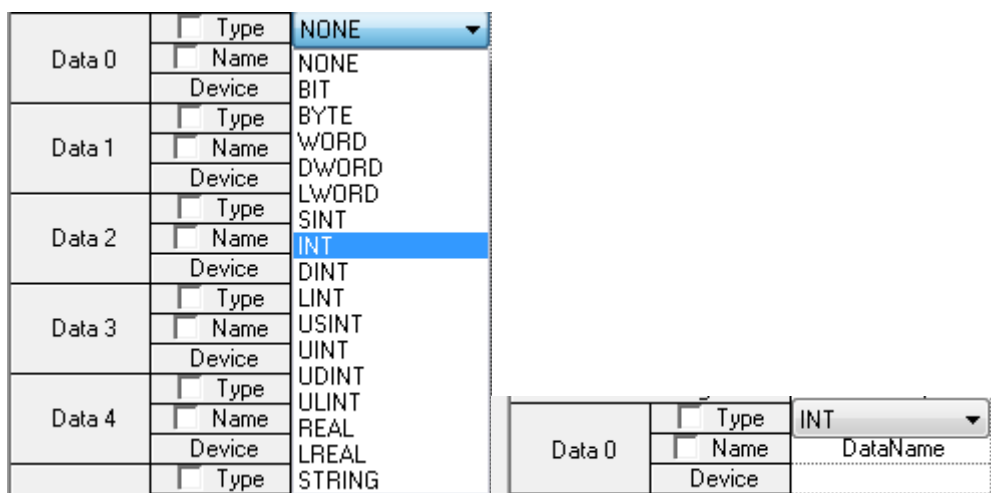

- 4) Connect the SD memory card, and turn on the Data Log Enable Flag (K40000) when the DL RDY (K40010) Flag is On to activate the function. Data log will not be activated if the Enable Flag is ON while DL RDY (K40010) Flag is OFF.
- The following are Enable Flags for each data log group

Item	Type	Description
%KW4000	WORD	Data Log Enable Flags
%KX64000	BIT	Group 0 Enable Flag 1: Operation, 0: Stop
%KX64001	BIT	Group 1 Enable Flag 1: Operation, 0: Stop
%KX64002	BIT	Group 2 Enable Flag 1: Operation, 0: Stop
%KX64003	BIT	Group 3 Enable Flag 1: Operation, 0: Stop
%KX64004	BIT	Group 4 Enable Flag 1: Operation, 0: Stop
%KX64005	BIT	Group 5 Enable Flag 1: Operation, 0: Stop
%KX64006	BIT	Group 6 Enable Flag 1: Operation, 0: Stop
%KX64007	BIT	Group 7 Enable Flag 1: Operation, 0: Stop
%KX64008	BIT	Group 8 Enable Flag 1: Operation, 0: Stop
%KX64009	BIT	Group 9 Enable Flag 1: Operation, 0: Stop

OFF the data log Enable Flag (%KX64000) to stop data saving.

When the SD memory still has data to save, the Log Ending flag turns ON, and back to OFF once all data are saved.

The data STOP progress can be verified though LOG, STOP Progress flag. When the flag value is 100, it indicates completion of all data save.

5.5 Trigger Save

Trigger Save refers to saving a set number of data before and after the relevant point: the number of data is set by parameter. This method is useful when you want to view data from a certain period before and after a certain event. When Event Save method is used, data are saved after END of each scan where the set bit condition occurred.

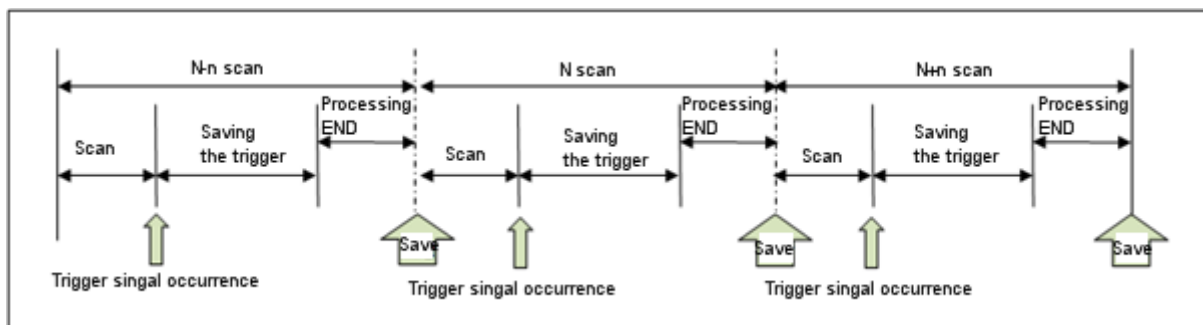
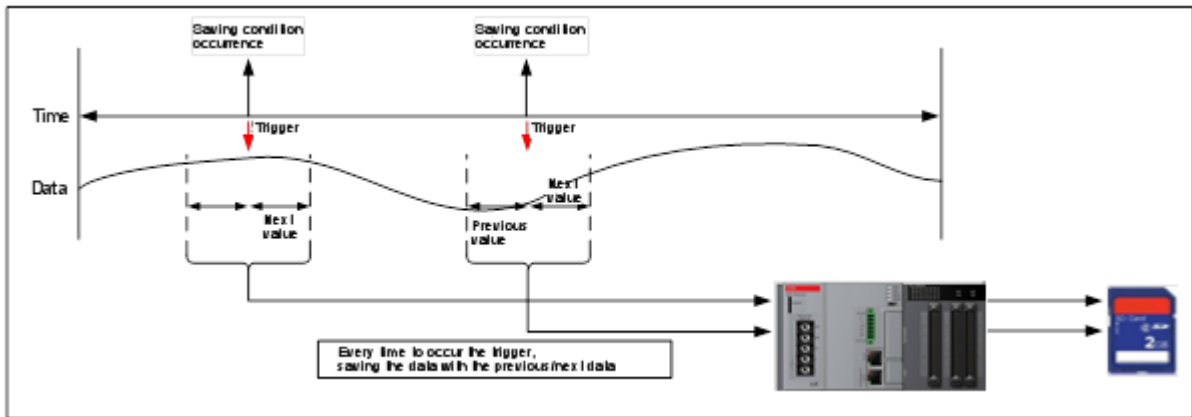

Note

After selecting Trigger Save, if the first trigger condition occurs and another trigger condition occurs while collecting data, the new trigger is ignored and the trigger reoccurrence flag value increases.

5.5.1 Trigger Condition

Trigger Save function runs under Single Condition, Multiple Condition. The setting item for single/multiple conditions are as follows. Multiple Condition runs by connecting Single Condition using AND, OR. Up to 4 Single Conditions can be set to form a condition. When the Trigger Condition occurs and data saving initiates, T character string is inserted into the first data string to indicate the trigger starting point.

(1) Single Condition

Single Condition runs under BIT Condition, WORD Condition.

1) BIT Condition

BIT condition checks the set device BIT value, and collects data by detecting trigger when the value is either [elevation] or [descent].

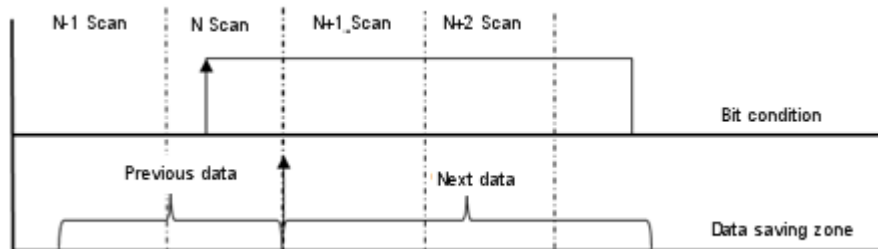

2) WORD Condition

Word Condition compares the set device with the input value, and converts them into TRUE or FALSE. If the set device value satisfies the input condition, data are collected when the value is either [elevation] or [descent].

Ex) If set value is <50, elevation condition

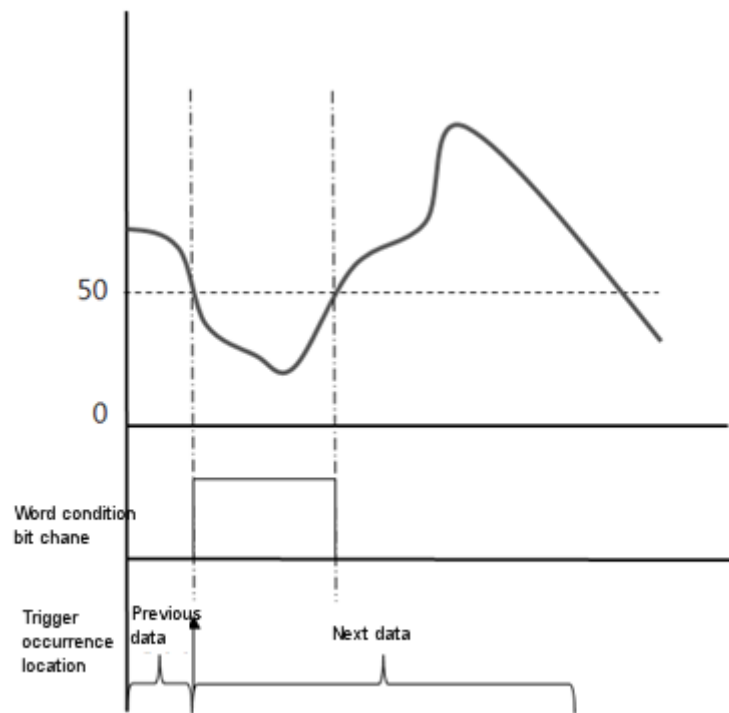

3) Condition Description

	Trigger Occurrence Condition	Device Set Condition	Operation	Note
BIT Condition	Elevation	X	Saves data at elevation edge of set device bit value	
	Descent		Saves data at descent edge of set device bit value	
Word Condition	Elevation	small	Saves data at the elevation edge of the relevant bit, when the set word device value is smaller than the input set value	
	Descent		Saves data at the descent edge of the relevant bit, when the set word device value is smaller than the input set value	
	Elevation	Small or Same	Saves data at the elevation edge of the relevant bit, when the set word device value is smaller than or the same as the input set value	
	Descent		Saves data at the descent edge of the relevant bit, when the set word device value is smaller than or the same as the input set value	
	Elevation	Large	Saves data at the descent edge of the relevant bit, when the set word device value is larger than the input set value	
	Descent		Saves data at the descent edge of the relevant bit, when the set word device value is larger than the input set value	
	Elevation	Large or Same	Saves data at the elevation edge of the relevant bit, when the set word device value is larger than or the same as the input set value	
	Descent		Saves data at the descent edge of the relevant bit, when the set word device value is larger than or the same as the input set value	
	Elevation	Same	Saves data at the elevation edge of the relevant bit, when the set word device value is the same as the input set value	
	Descent		Saves data at the descent edge of the relevant bit, when the set word device value is the same as the input set value	
	Elevation	Different	Saves data at the elevation edge of the relevant bit, when the set word device value is different from the input set value	
	Descent		Saves data at the descent edge of the relevant bit, when the set word device value is different from the input set value	

(2) Multiple Condition

Multiple Condition refers to setting up to 4 single conditions and operating by performing the operations that fit the conditions

At least two Single Conditions should be set. Trigger Save begins when operation with the set single conditions satisfy the result.

Multiple Condition runs under AND Calculation, OR Calculation.

Note

When less than 2 single conditions are set for trigger multiple condition, the following error message is displayed.

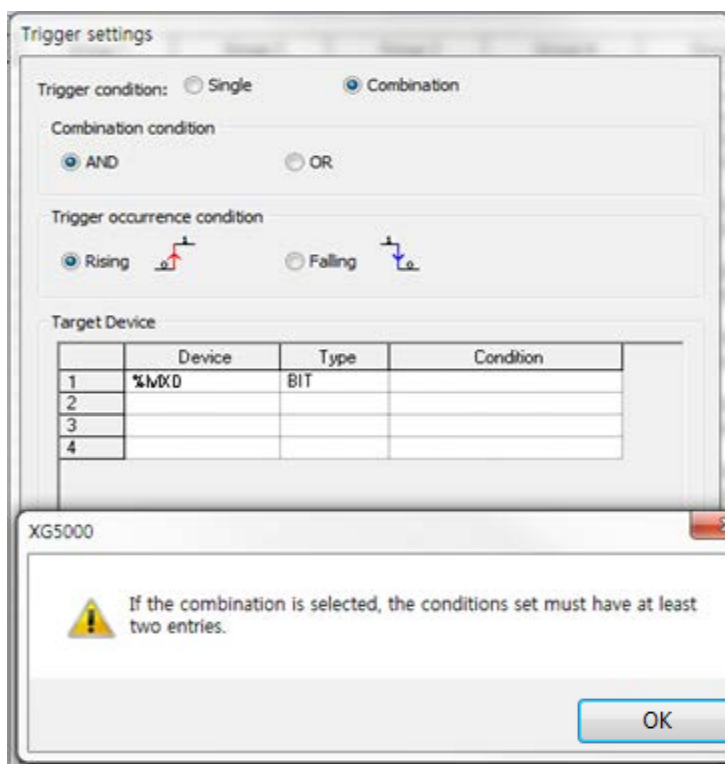

1) AND Calculation

Trigger occurs when all relevant conditions are satisfied at a single scan.

The following figure shows an example of trigger save activated by trigger elevation and descent occurring at one scan.

☞ When setting only with BIT condition

	Condition	Set Device	Trigger Occurrence Condition
Condition 0	BIT	%MX1010	Elevation
Condition 1	BIT	%IX0.0.1	
Condition 2	BIT	%MX2010	
Condition 3	BIT	%QX0.2.2	

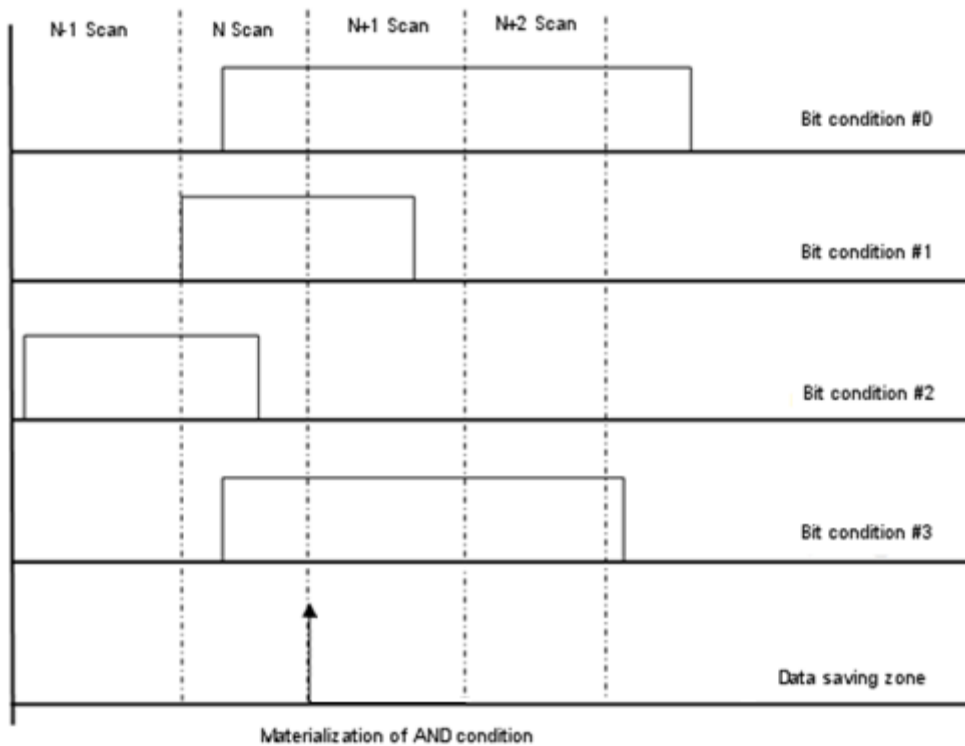

☞ When setting with combination of Bit and WORD conditions

	Condition	Comparison Condition	Set Value	Set Device	Trigger Occurrence Condition
Condition 0	Word	<	50	%MW10	Elevation
Condition 1	BIT			%MX15	

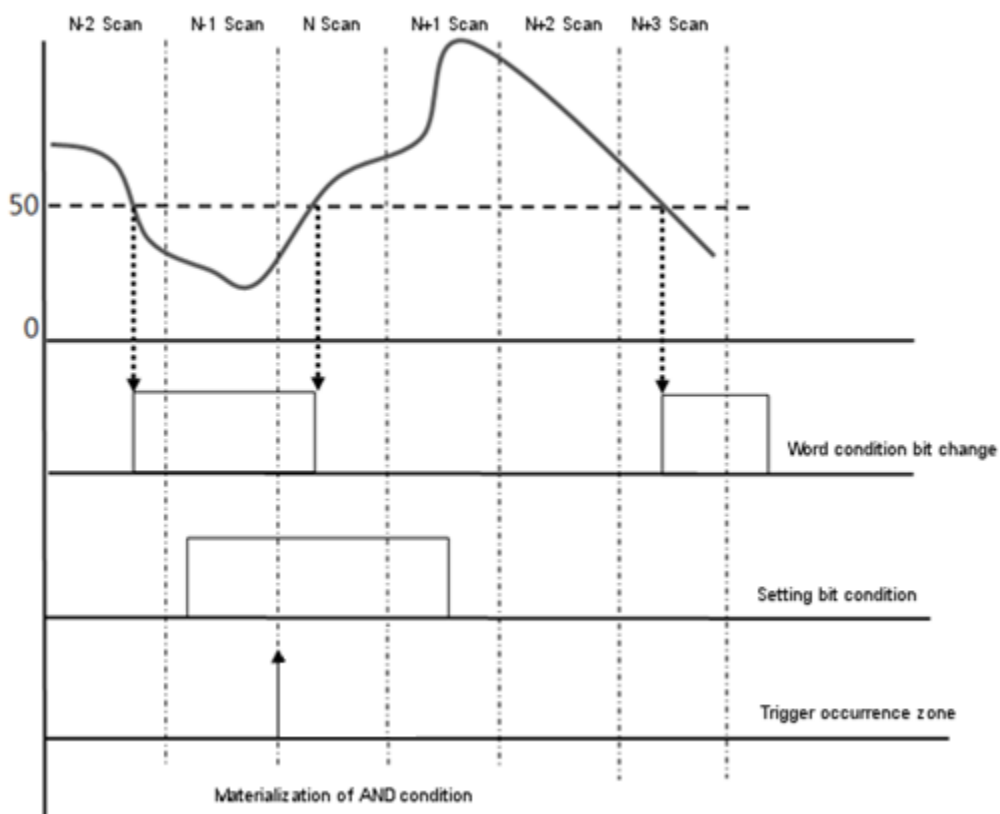

2) OR Calculation

Trigger occurs when even one condition is satisfied at a single scan. After selecting Trigger Save, if the Trigger Condition is again satisfied before data saving is complete, the new trigger is ignored and the trigger reoccurrence flag value increases.

☞ When setting only with BIT condition

	Condition	Set Device	Trigger Occurrence Condition
Condition 0	BIT	%MX1010	Elevation
Condition 1	BIT	%IX0.0.1	
Condition 2	BIT	%MX2010	
Condition 3	BIT	%QX0.2.2	

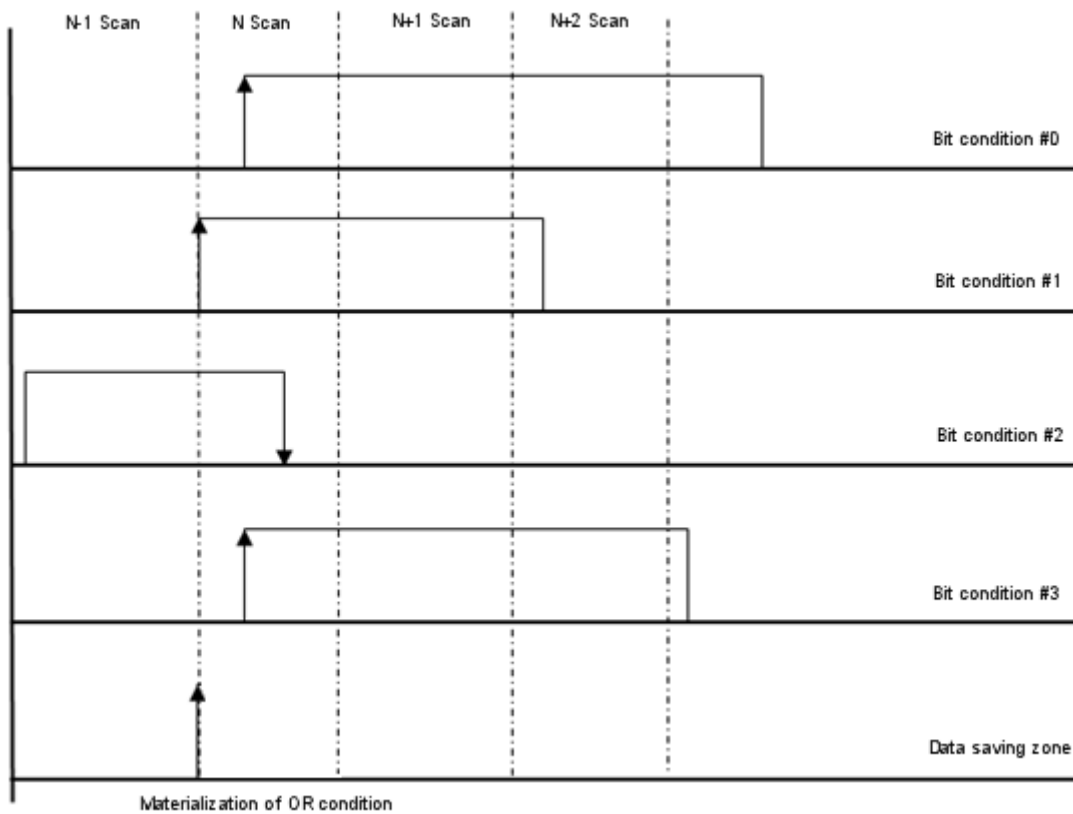

☞ When setting with combination of Bit and WORD conditions

	Condition	Comparison Condition	Set Value	Set Device	Trigger Occurrence Condition
Condition 0	Word	<	50	%MW10	Elevation
Condition 1	BIT			%MX15	

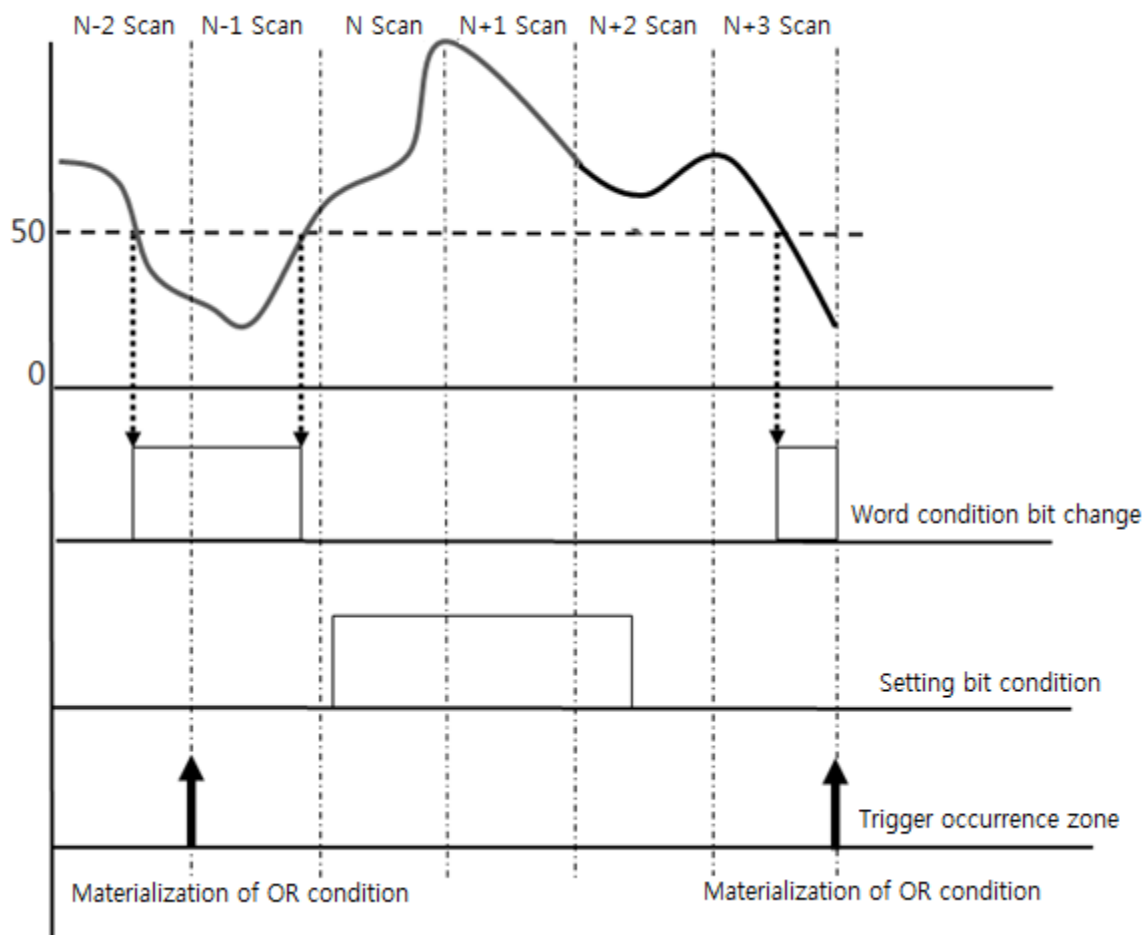

5.5.2 Trigger Sample Block Calculation

During Trigger Save, data collection progresses for each sample block. Sample block refers to the unit of collected data set by the data log parameter, where sample refers to each data value. The number of trigger sample blocks and the total number of samples are calculated as follows.

$$\text{No. of sample blocks} = \text{Trigger Buffer Space}^1 / \{(\text{No. of set data}^2 * \text{size of set data}^3) + (\text{RTC data size}^4)\}$$

$$\text{No. of stored samples} = \text{sample block} * \text{No. of set data}$$

- 1) Trigger Buffer Space: 8960 Word/Group
- 2) No. of Set Data 32 (Maximum)
- 3) Size of Set Data

Data Type	Data Size
BIT	1
BYTE	1
WORD	1
DWORD	2
LWORD	4
INT	1
SINT	1
DINT	2
LINT	4
UINT	1
USINT	1
UDINT	2
ULINT	4
REAL	2
LREAL	4
STRING	16

Ex)

- No. and Type of Set Data 20 (INT 10, DWORD 10)

◆ Max. No. of sample blocks that can be set:
 $8960 / \{(10 * 1) + (10 * 2) + 3\} = 271$ sample blocks

◆ Total No. of Samples

$$271 * 20 = 5420 \text{ samples}$$

- 4) RTC size of data : 3 words (fixed value)

5.5.3 Trigger Sample Calculation

The item that can be set at the parameter is the total number of trigger sample blocks and the number of sample blocks before trigger condition. The number of sample blocks after trigger is determined by the two input values

$$\begin{array}{l} \text{Total Number of Trigger} \\ \text{Samples} \\ \text{(Setting Available)} \end{array} = \begin{array}{l} \text{Number of Samples before} \\ \text{Trigger Condition} \\ \text{(Setting Available)} \end{array} + \begin{array}{l} \text{Number of Samples after Trigger Condition} \\ \text{Setting Available} \end{array}$$

5.5.4 Trigger Sample Save Cycle

When Trigger Condition occurs, data collected are saved at the sampling interval set by the parameter. The saving interval is as follows.

→ Scan interval, 100 ms, 200 ms, 500 ms, 1000 ms, 2000 ms

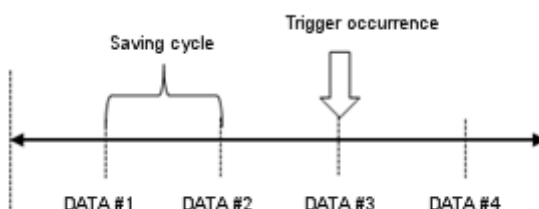

Caution

After selecting Trigger Save, if the Trigger Condition is again satisfied before data saving is complete, the new trigger is ignored and the trigger reoccurrence flag value increases. Trigger Condition is checked after saving the set number of trigger sample blocks, and then the data are saved.

5.5.5 Trigger Sample Save Section

- (1) If Trigger occurs after the number of previous data set by the parameter

→ Saves data in the number set by the parameter

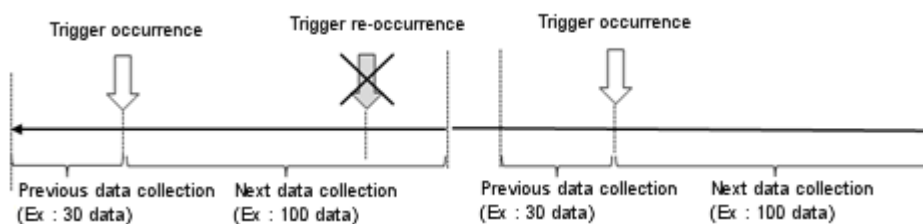

- (2) If Trigger occurs before the number of previous data set by the parameter

→ Saves data in the number of transfer data collected, and then collects subsequent data (Saves less number of data than the number set by the parameter)

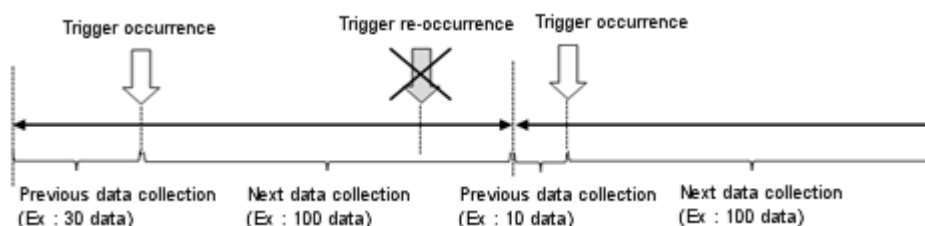

5.5.6 Setting Method

(1) Single BIT Condition

- 1) Choose XG5000 –[Project Window] - [internal parameter] - [data log]
This activates the data log parameter setting window.

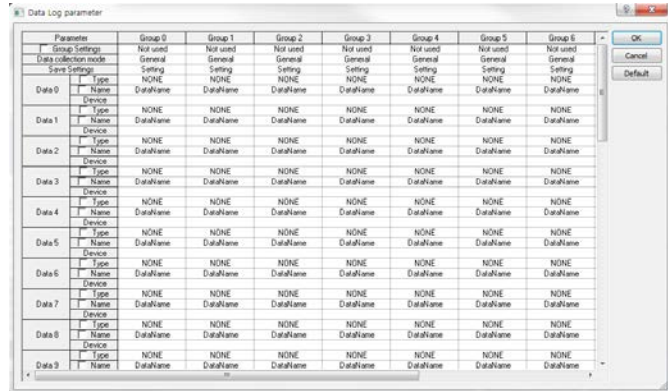
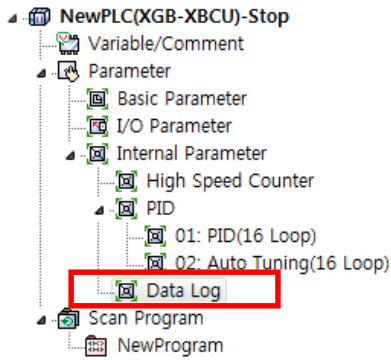

- 2) Set the group to use on the data log parameter window.



- 3) Select [Trigger Logging] at [Data Collection Method] to activate [Setting] menu on the left. Then, select the [Setting] menu on the left.

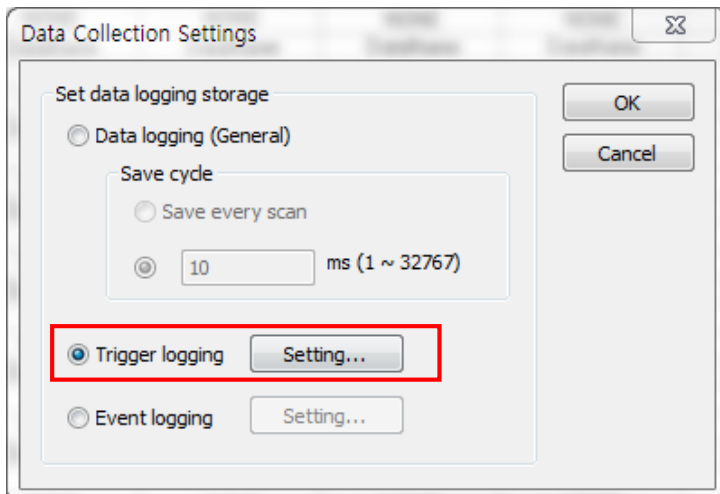



Upon selection, the following window is activated for trigger setting.

Select [Single Condition] as the Trigger Condition. Select either [Elevation] or [Descent] as the Trigger Occurrence Condition.

Trigger settings

Trigger condition: Single Combination

Combination condition
 AND OR

Trigger occurrence condition
 Rising  Falling 

Target Device

	Device	Type	Condition
1			
2			
3			
4			

Sample Block settings
 Sampling frequency: Scan Tim 2240 Sample
 Total sample blocks: 200 Sample (Max.:
 Sample blocks after: 200 Sample

OK Cancel

- 5) Select the condition setting menu to activate the following setting window. Select [BIT Condition], and input device values into the device window in BIT types.

Trigger settings

Conditions set
 Bit condition
 Device: %MXD
 Word condition
 Device: < > 0



OK Cancel

When setting is complete, the window closes and the conditions initially set at the Trigger Setting Condition menu are displayed as follows.

Trigger settings

Trigger condition: Single Combination

Combination condition
 AND OR

Trigger occurrence condition
 Rising  Falling 

Target Device

	Device	Type	Condition
1	%MXD	BOOL	
2			
3			
4			

Sample Block settings
 Sampling frequency: Scan Tim 2240 Sample
 Total sample blocks: 200 Sample (Max.:
 Sample blocks after: 200 Sample

OK Cancel

- 6) Select Trigger Occurrence Condition value.

Trigger settings

Trigger condition: Single Combination

Combination condition
 AND OR

Trigger occurrence condition
 Rising Falling

Target Device			
	Device	Type	Condition
1	%MX0	BOOL	
2			
3			
4			

Sample Block settings

Sampling frequency: Scan Tim 2240 Sample

Total sample blocks: 200 Sample (Max.: 2240 Sample)

Sample blocks after: 200 Sample

OK Cancel

- 7) Input sampling interval, total number of samples and number of samples after trigger, then finish Trigger setting. See [5.5.2 Trigger Sample Block Calculation] for operation of number of sample blocks.
- 8) Device values set at the Data Log Basic Setting window are collected, and saved into the SD memory after type conversion.

Data 0	<input type="checkbox"/> Type	NONE
	<input type="checkbox"/> Name	NONE
	Device	BOOL
Data 1	<input type="checkbox"/> Type	BYTE
	<input type="checkbox"/> Name	WORD
	Device	DWORD
Data 2	<input type="checkbox"/> Type	LWORD
	<input type="checkbox"/> Name	SINT
	Device	INT
Data 3	<input type="checkbox"/> Type	DINT
	<input type="checkbox"/> Name	LINT
	Device	USINT
Data 4	<input type="checkbox"/> Type	UINT
	<input type="checkbox"/> Name	UDINT
	Device	ULINT
	<input type="checkbox"/> Type	REAL
	<input type="checkbox"/> Name	LREAL
	<input type="checkbox"/> Type	STRING

(2) Single WORD Condition

- 1) Choose XG5000 –[Project Window] - [internal parameter] - [data log]

This activates the data log parameter setting window.

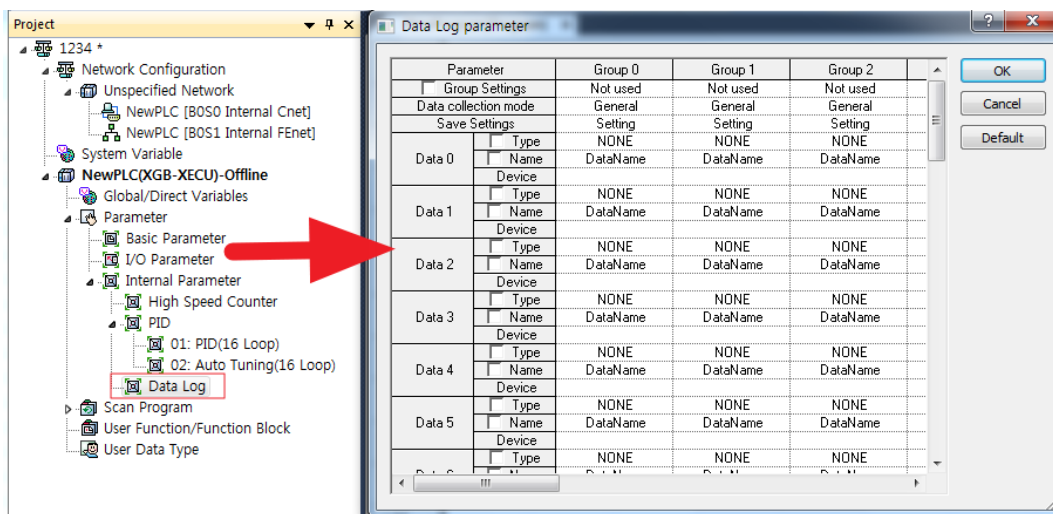

- 2) Set the group to use on the data log parameter window.



- 3) Select [Trigger Logging] at [Data Collection Method] to activate [Setting] menu on the left.

Then, select the [Setting] menu on the left.

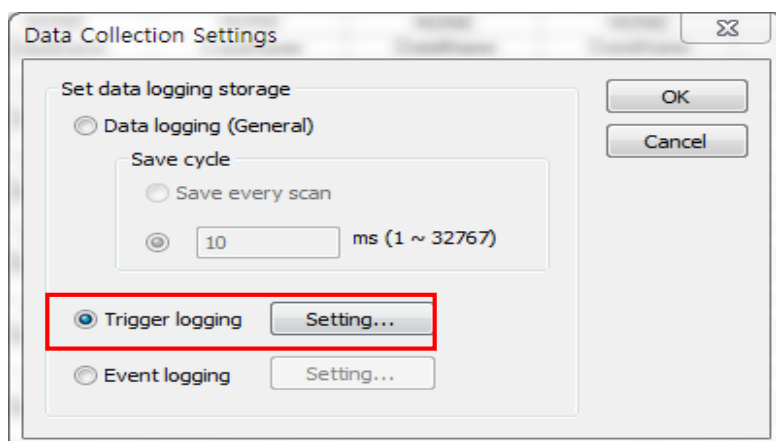



- 4) Upon selection, the following window is activated for trigger setting. Select [Single Condition] as the Trigger Condition. Select either [Elevation] or [Descent] as the Trigger Occurrence Condition.

Trigger settings

Trigger condition: Single Combination

Combination condition
 AND OR

Trigger occurrence condition
 Rising  Falling 

Target Device

	Device	Type	Condition
1			
2			
3			
4			

Sample Block settings
 Sampling frequency: Scan Tim 2240 Sample
 Total sample blocks: 200 Sample (Max.:
 Sample blocks after: 200 Sample

OK Cancel

- 5) Select the condition setting menu to activate the following setting window. Select [Word Condition], and input device values into the device window in BIT types, and input comparison condition and comparison values
- ▣ **Comparison Condition: Large, Large or Same, Same, Small, Small or Same, Not Same.**

Trigger settings

Conditions set
 Bit condition
 Word condition

Device M0100 >= 50



OK Cancel

When setting is complete, the window closes and the conditions initially set at the Trigger Setting Condition menu are displayed as follows.

Trigger settings

Trigger condition: Single Combination

Combination condition
 AND OR

Trigger occurrence condition
 Rising  Falling 

Target Device

	Device	Type	Condition
1			
2			
3			
4			

Sample Block settings
 Sampling frequency: Scan Tim 2240 Sample
 Total sample blocks: 200 Sample (Max.:
 Sample blocks after: 200 Sample



OK Cancel

- 6) Select Trigger Occurrence Condition value.

Trigger settings

Trigger condition: Single Combination

Combination condition
 AND OR

Trigger occurrence condition
 Rising  Falling 

Target Device

	Device	Type	Condition
1	%Mx100	BOOL	
2			
3			
4			

Sample Block settings

Sampling frequency: 2240 Sample

Total sample blocks: Sample (Max.:

Sample blocks after: Sample

OK Cancel

- 7) Input sampling interval, total number of samples and number of samples after trigger, then finish Trigger setting. See [5.5.2 Trigger Sample Block Calculation] for operation of number of sample blocks.
- 8) Device values set at the Data Log Basic Setting window are collected, and saved into the 3 after type conversion.

Caution

(4) When inputting single, word condition set values, set device type as [BIT] and [WORD], respectively.

(5)

(3) Multiple AND Condition

- 1) Choose XG5000 –[Project Window] - [internal parameter] - [data log]

This activates the data log parameter setting window.

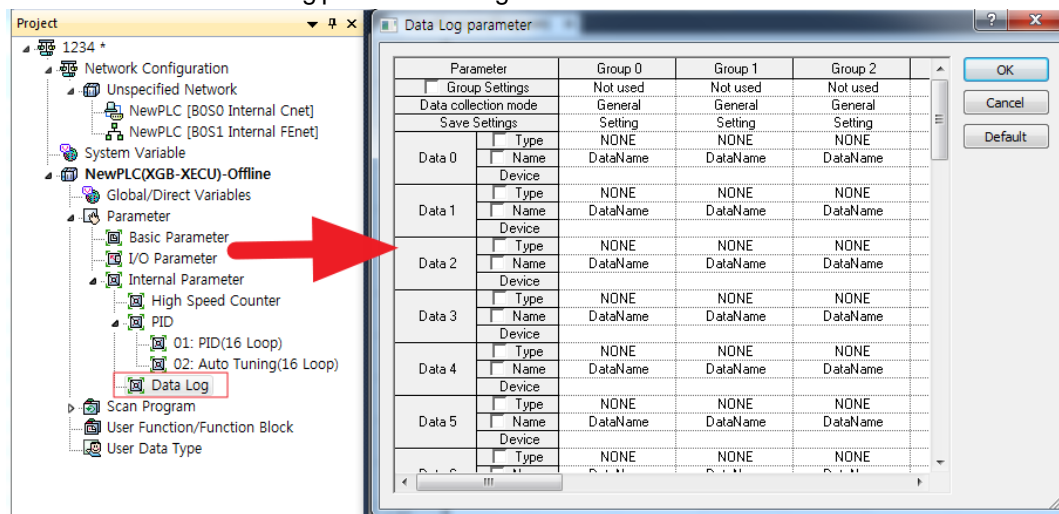

- 2) Set the group to use on the data log parameter window.

3)



- 3) Select [Trigger Logging] at [Data Collection Method] to activate [Setting] menu on the left. Then, select the [Setting] menu on the left.

4)

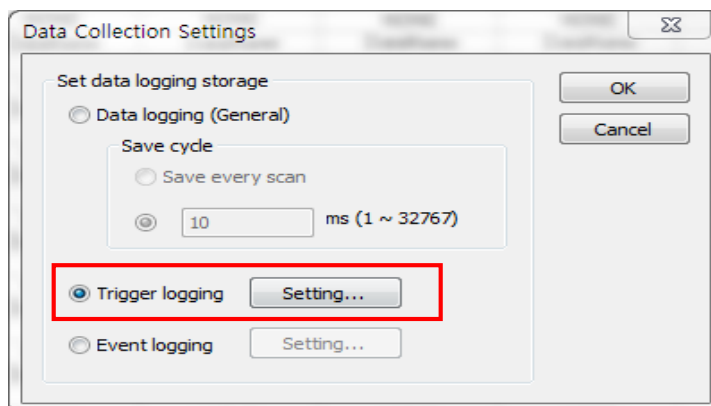

- 4) Upon selection, the following window is activated for trigger setting. Select [Multiple Condition] as Trigger Condition, Select either [Elevation] or [Descent] as the Trigger Occurrence Condition.

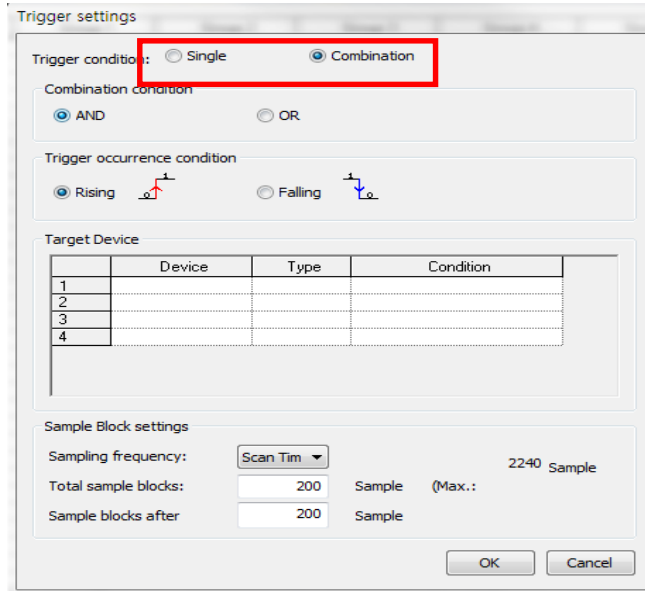

- 5) Select [Trigger Condition] and [Multiple Condition] to activate the condition setting window which allows for up to 4 inputs.

Target Device			
	Device	Type	Condition
1			
2			
3			
4			

- 6) Select each condition setting menu one by one, inputting specific set values. [Multiple Condition] activates Trigger Condition by combining [Single Conditions] through operation to save data. As described below, the basic setting method is the same as that of Single Condition.

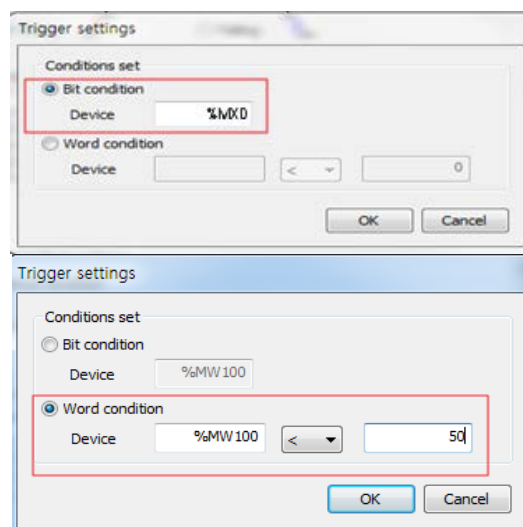

When setting is complete, the window closes and the conditions initially set at the Trigger Setting Condition menu are displayed as follows.

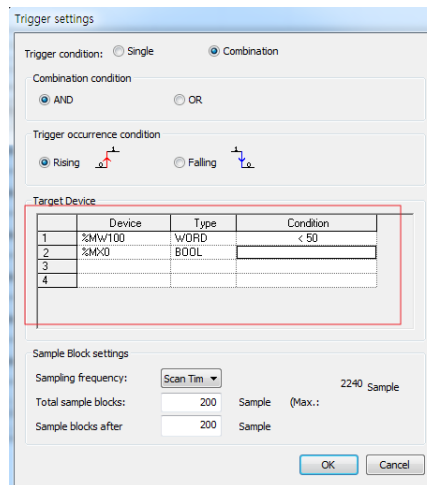

If only one [Condition Setting] is input after selecting Calculation Condition before finishing the setting, the following phrase is displayed and the setting is not complete.

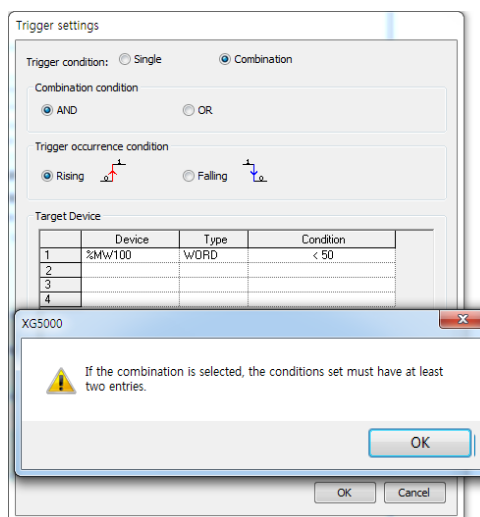

- 7) Input sampling interval, total number of samples and number of samples after trigger, then finish Trigger setting.
- 8) Device values set at the Data Log Basic Setting window are collected when the Trigger Condition occurs, converted into the set type, and saved into the SD memory. Multiple OR Condition

Data 0	Type	NONE
	Name	NONE
	Device	BIT
Data 1	Type	BYTE
	Name	WORD
	Device	DWORD
Data 2	Type	LWORD
	Name	SINT
	Device	INT
Data 3	Type	DINT
	Name	LINT
	Device	USINT
Data 4	Type	UINT
	Name	UDINT
	Device	ULINT
	Type	REAL
	Name	LREAL
	Device	STRING

(4) Multiple OR Condition

[Trigger Setting] is identical to the [Multiple OR Calculation] above.

- 1) Select each condition setting menu one by one, inputting specific set values.
[Multiple Condition] activates Trigger Condition by combining [Single Conditions] through operation to save data. As described below, the basic setting method is the same as that of Single Condition.

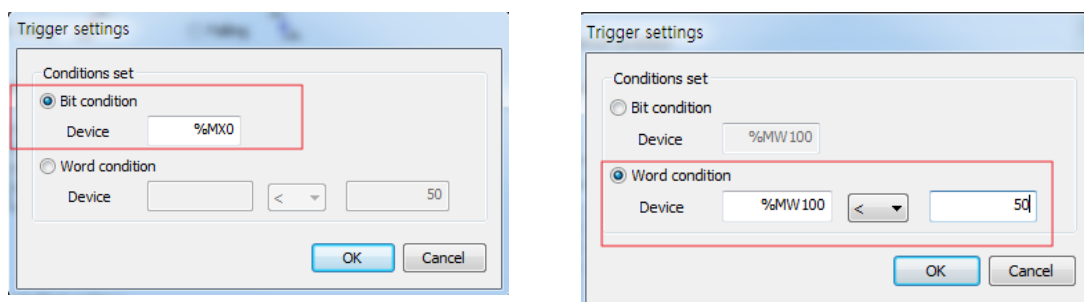

When setting is complete, the window closes and the conditions initially set at the Trigger Setting Condition menu are displayed as follows.

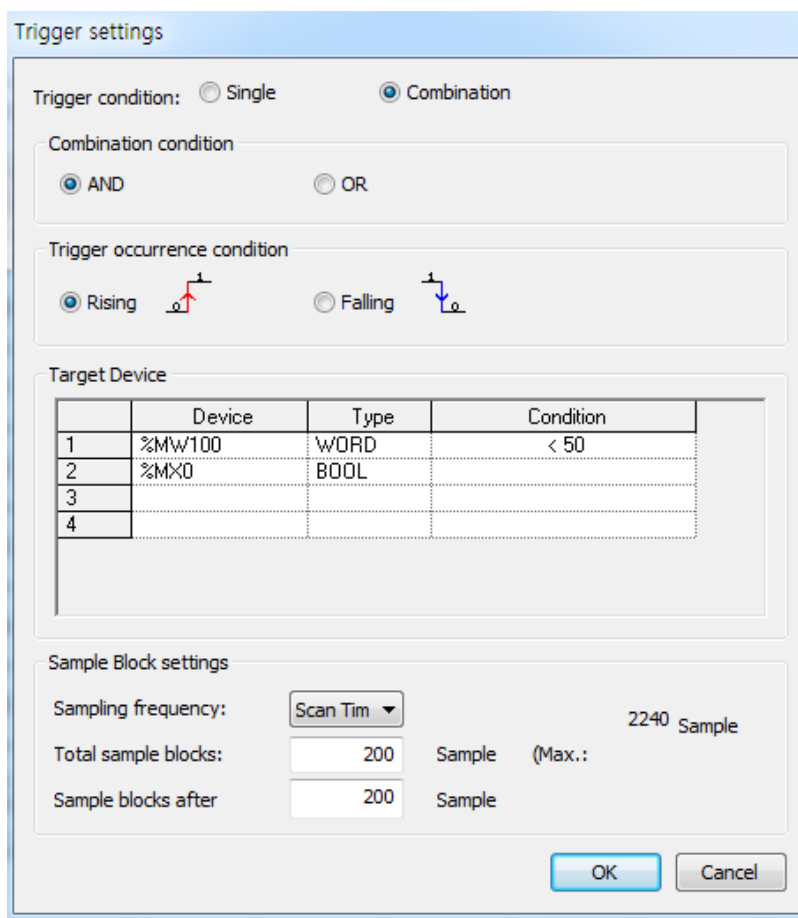

If only one [Condition Setting] is input after selecting Calculation Condition before finishing the setting, the following phrase is displayed and the setting is not complete.

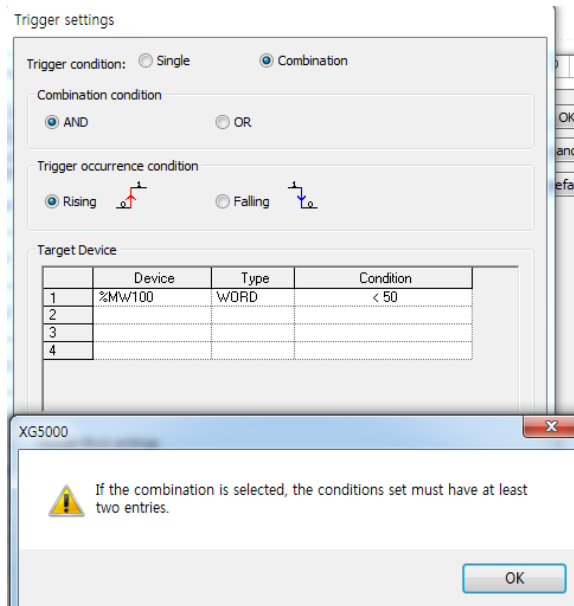

- 2) Input sampling interval, total number of samples and number of samples after trigger, then finish Trigger setting.
- 3) Device values set at the Data Log Basic Setting window are collected when the Trigger Condition occurs, converted into the set type, and saved into the SD memory.

Data 0	Type	NONE
	Name	NONE
	Device	BIT
Data 1	Type	BYTE
	Name	WORD
	Device	DWORD
Data 2	Type	LWORD
	Name	SINT
	Device	INT
Data 3	Type	DINT
	Name	LINT
	Device	USINT
Data 4	Type	UINT
	Name	UDINT
	Device	ULINT
	Type	REAL
	Device	LREAL
	Type	STRING

5.6 Event Save

Event Save refers to monitoring the device value collected, and saving the present data when a certain event condition is satisfied. This method is useful for analyzing fluctuation of event values and timing by saving data from the event occurrence to the event termination. Event Save refers to saving data when the event occurs, until the conditions are not satisfied.

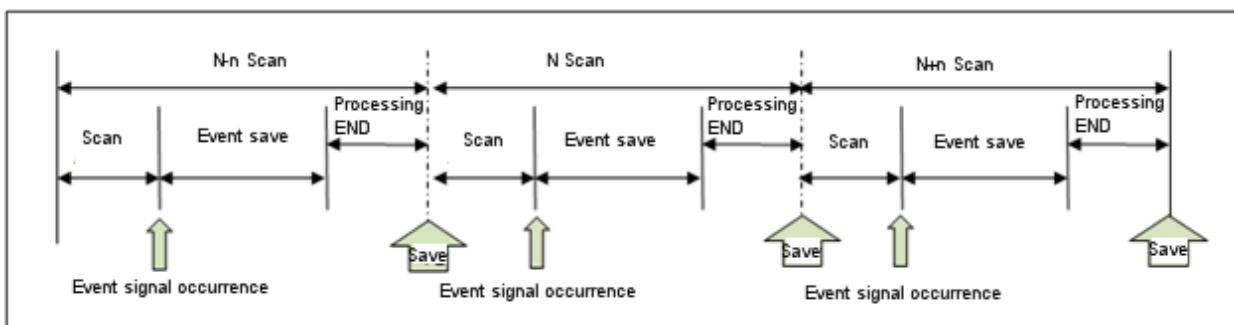
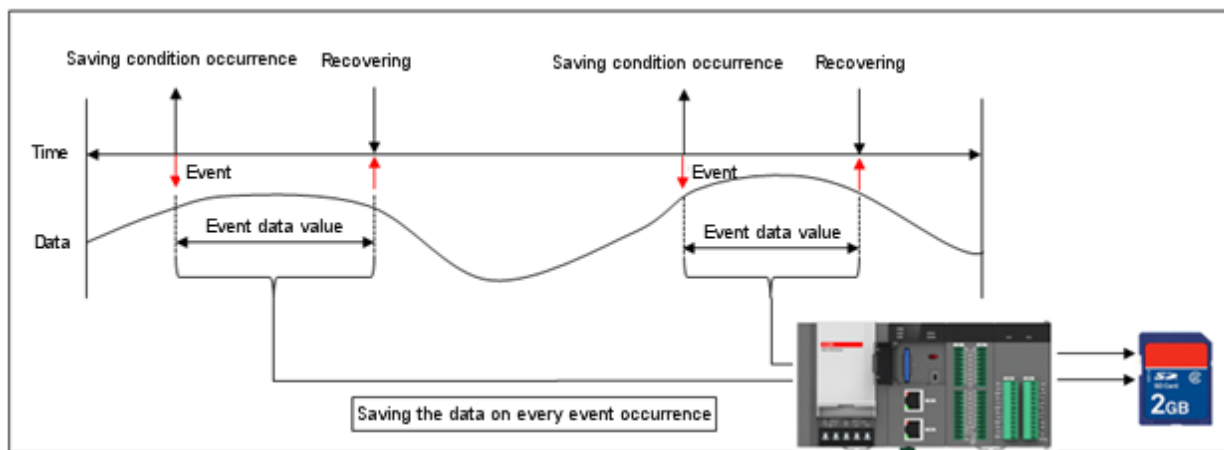

Note

After selecting Trigger Save, if the first trigger condition occurs and another trigger condition occurs while collecting data, the new trigger is ignored.

5.6.1 Event Condition

Event Save function runs under Single Condition, Multiple Condition. The setting item for single/operation conditions are as follows. Multiple Condition runs by connecting Single Condition using operation. Up to 4 Single Conditions can be set to form a condition. When the Trigger Condition occurs and data saving initiates, E character string is inserted into the first data string to indicate the trigger starting point.

(1) Single Condition

Single Condition runs under BIT Condition, WORD Condition.

1) BIT Condition

BIT condition checks the set device BIT value, and collects data by detecting trigger when the value is either [elevation], [descent], [transfer], [ON], or [OFF].

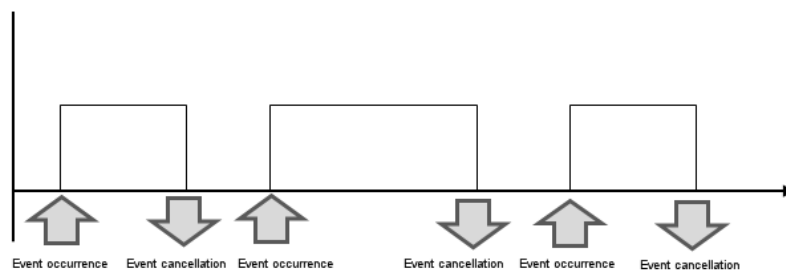

2) WORD Condition

Word Condition compares the set device with the input value, and converts them into TRUE or FALSE. If the set device value satisfies the input condition, saves data when the value is [elevation], [descent], [transfer], [ON], or [OFF].

Ex) If set value is >50, elevation condition

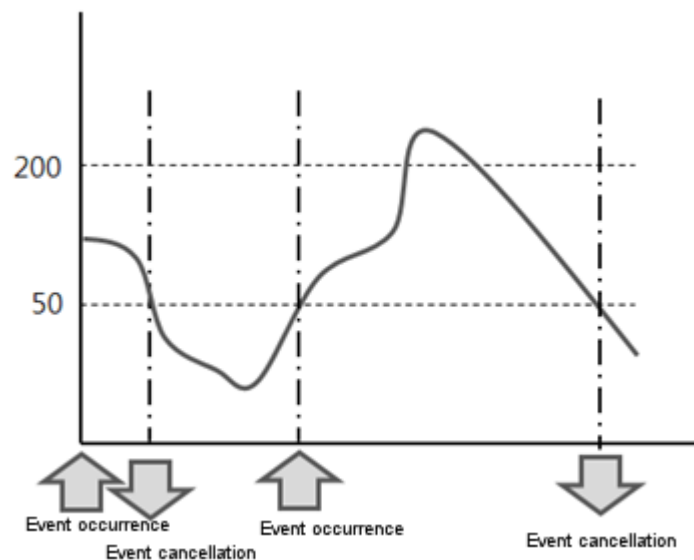

3) Release Value Setting

Among Event Save functions, release value setting can be done only in WORD Condition. It affects data save interval and frequency. Once the release value is set, the condition after event occurrence saves data until the release value is satisfied.

	Use Release Value Setting	Do Not Use Release Value Setting
%MW0 > 100	☞ Release Value Setting 50 Saves data until the setting value after event occurrence is 50	Saves data until the condition is met after event occurrence
%MW0 >= 100		
%MW0 == 100	Release Value Cannot be Set	
%MW0 < 100	☞ Release Value: 120 Saves data until the setting value after event occurrence is 120	
%MW0 <= 100		
%MW0 <> 100	Release Value Cannot be Set	

Note

Release value can be set as follows. If the following is not complied with, an error window will appear and data input will not work. Check it when setting the parameter.

☞ Release value many not overlap with the range of set values.

Condition	Range of Release Value
Large	Set Value >= Release Value
Large or Same	Set Value > Release Value
small	Set Value <= Release Value
Small or Same	Set Value <= Release Value
Same	Setting Available
Not Same	

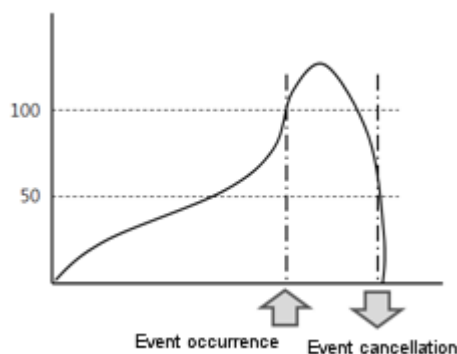

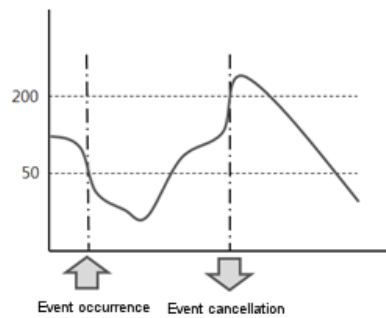

4) Condition Description

	Occurrence Condition	Device Set Condition	Operation	Release Value Release Value Setting	
BIT Condition	Elevation	X	Saves data at elevation edge of set device bit value	X	
	Descent		Saves data at descent edge of set device bit value		
	Transfer		Saves data when set device bit value is transferred		
	ON		Saves data when set device bit value is ON		
	OFF		Saves data when set device bit value is OFF		
Word Condition	Elevation	small	Saves data at the point where the condition conversion bit elevates when the set word device value is smaller than the input set value	Setting Available	
	Descent		Saves data at the point where the condition conversion bit descends when the set word device value is smaller than the input set value		
	Transfer		Saves data at the point where the condition conversion bit is transferred when the set word device value is smaller than the input set value		
	ON		Saves data at the point where the condition conversion bit is ON when the set word device value is smaller than the input set value		
	OFF		Saves data at the point where the condition conversion bit is OFF when the set word device value is smaller than the input set value		
	Same as Above		Small or Same	Saves data if the condition conversion bit satisfies the set condition when the set word device value is smaller than or the same as the input set value	Setting Available
			Large	Saves data if the condition conversion bit satisfies the set condition when the set word device value is larger than the input set value	Setting Available
			Large or Same	Saves data if the condition conversion bit satisfies the set condition when the set word device value is larger than or the same as the input set value	Setting Available
			Same	Saves data if the condition conversion bit satisfies the set condition when the set word device value is the same as the input set value	Setting Available
			Not Same	Saves data if the condition conversion bit satisfies the set condition when the set word device value is not the same as the input set value	Setting Available

(2) Multiple Condition

Multiple Condition refers to setting up to 4 single conditions and operating by performing the runs that fit the conditions
Event condition occurs when operation with the set condition satisfies the result

Setting	Operation	Note
AND Condition	Performs AND run with the set conditions, and saves data when the result is 1.	
OR Condition	Performs OR run with the set conditions, and saves data when the result is 1.	

1) AND Calculation

Event occurs when all relevant conditions are satisfied at a single scan. The following is an example of activating Event Save.

☞ When setting only with BIT condition

	Condition	Set Device	Event Occurrence Condition
Condition 0	BIT	%MX1010	Elevation
Condition 1	BIT	%IX0.0.1	
Condition 2	BIT	%MX2010	
Condition 3	BIT	%QX0.2.2	

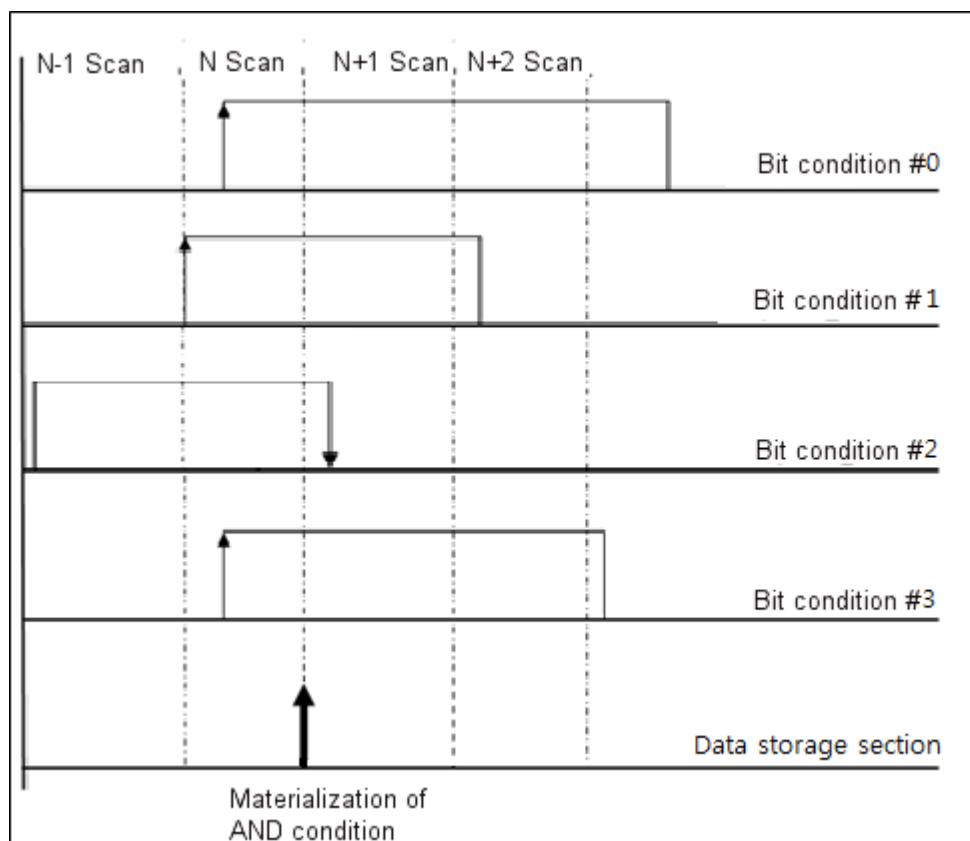

☞ When setting with combination of Bit and WORD conditions (no release value set)

	Condition	Comparis on Condition	Set Value	Release Value	Set Device	Event Occurrence Condition
Condition 0	Word	<	50	-	%MW100	Elevation
Condition 1	BIT	/			%MX15	

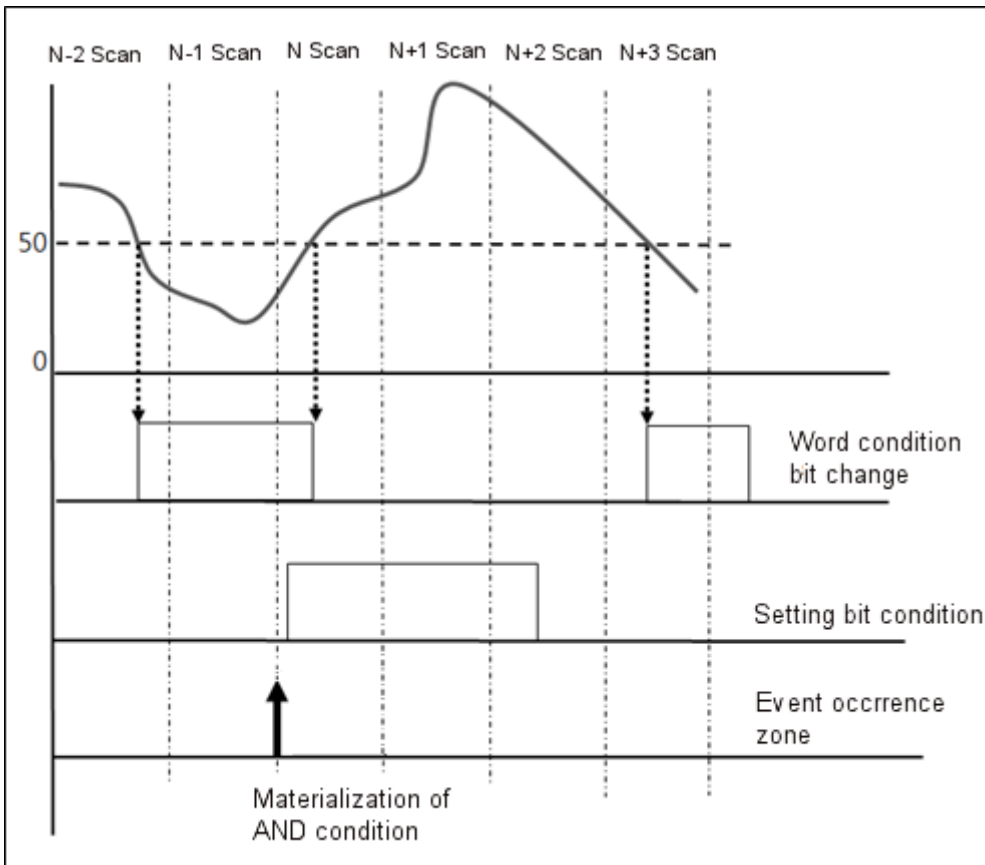

☞ When setting with combination of BIT and WORD conditions (release value set)

	Condition	Comparison Condition	Set Value	Release Value	Set Device	Event Occurrence Condition
Condition 0	Word	<	50	100	%MW100	Elevation
Condition 1	BIT	/			%MX15	

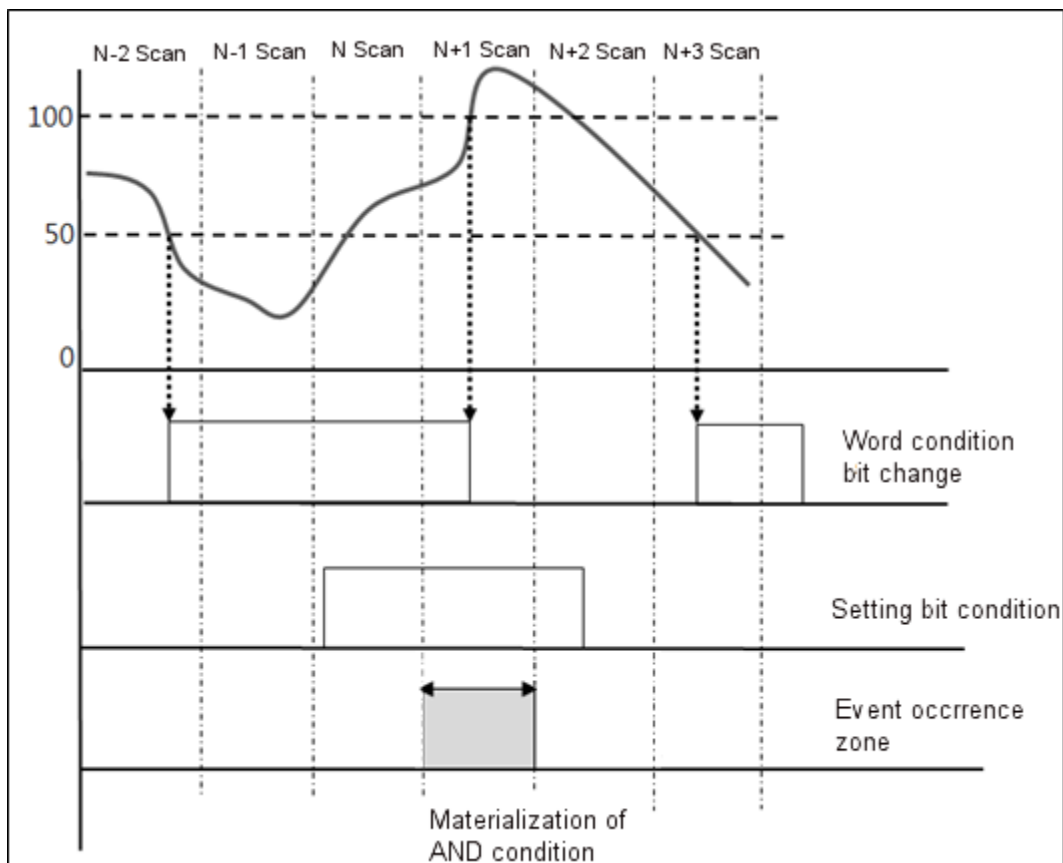

2) OR Calculation

Event occurs when even one condition is satisfied at a single scan. After selecting Trigger Save, if the Trigger Condition is again satisfied before data saving is complete, and the trigger reoccurrence flag value increases.

☞ When setting only with BIT condition

	Condition	Set Device	Event Occurrence Condition
Condition 0	BIT	%MX1010	ON
Condition 1	BIT	%IX0.0.1	
Condition 2	BIT	%MX2010	
Condition 3	BIT	%QX0.2.2	

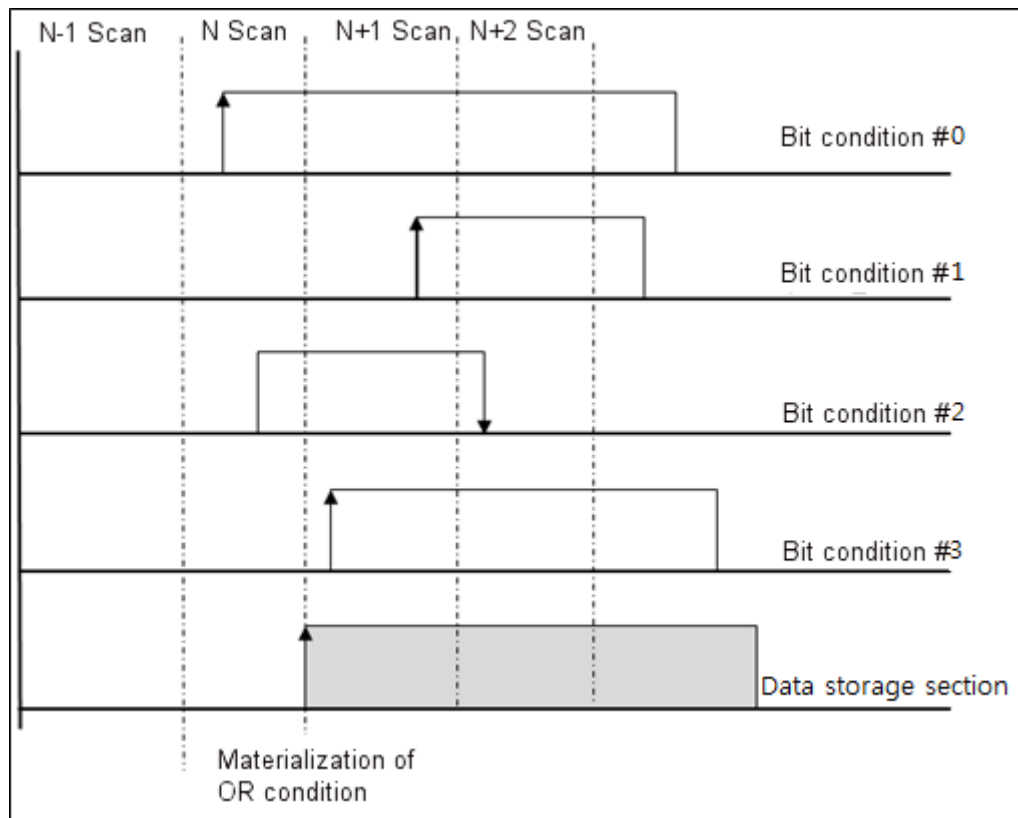

☞ When setting with combination of BIT and WORD conditions (no release value set)

	Condition	Comparison Condition	Set Value	Release Value	Set Device	Event Occurrence Condition
Condition 0	Word	<	50	-	%MW10	Elevation
Condition 1	BIT				%MX15	

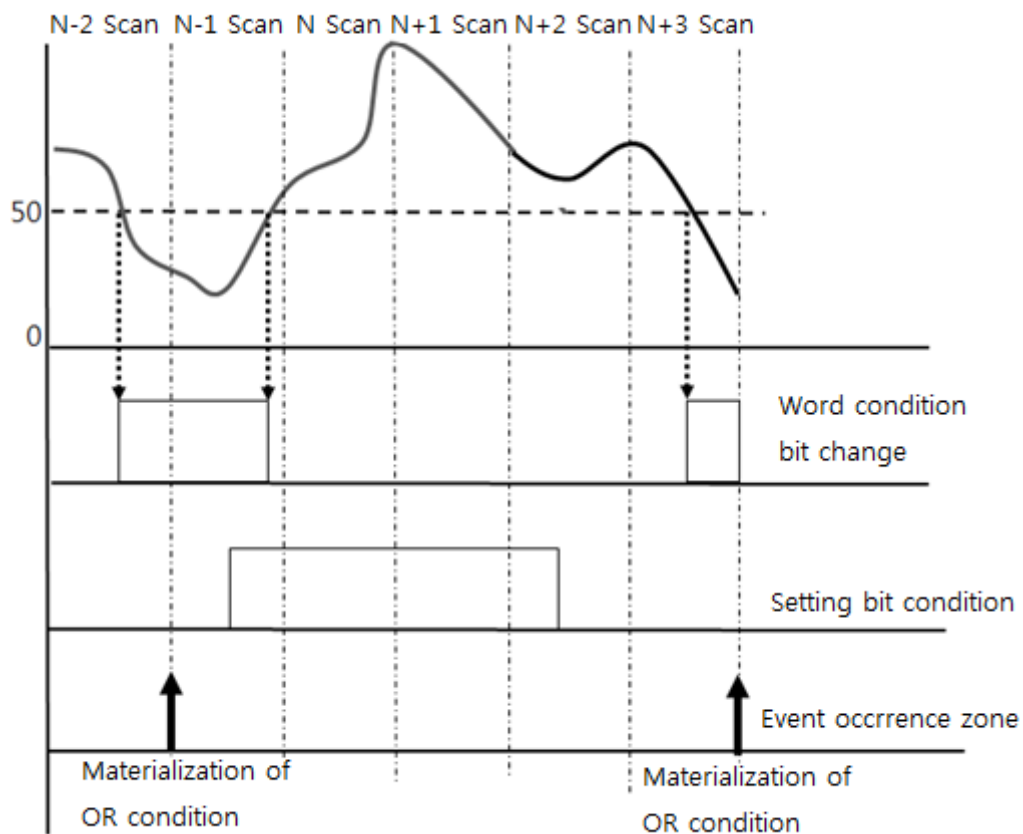

☞ When setting with combination of BIT and WORD conditions (release value set)

	Condition	Comparison Condition	Set Value	Release Value	Set Device	Event Occurrence Condition
Condition 0	Word	<	50	100	%MW10	ON
Condition 1	BIT				%MW15	

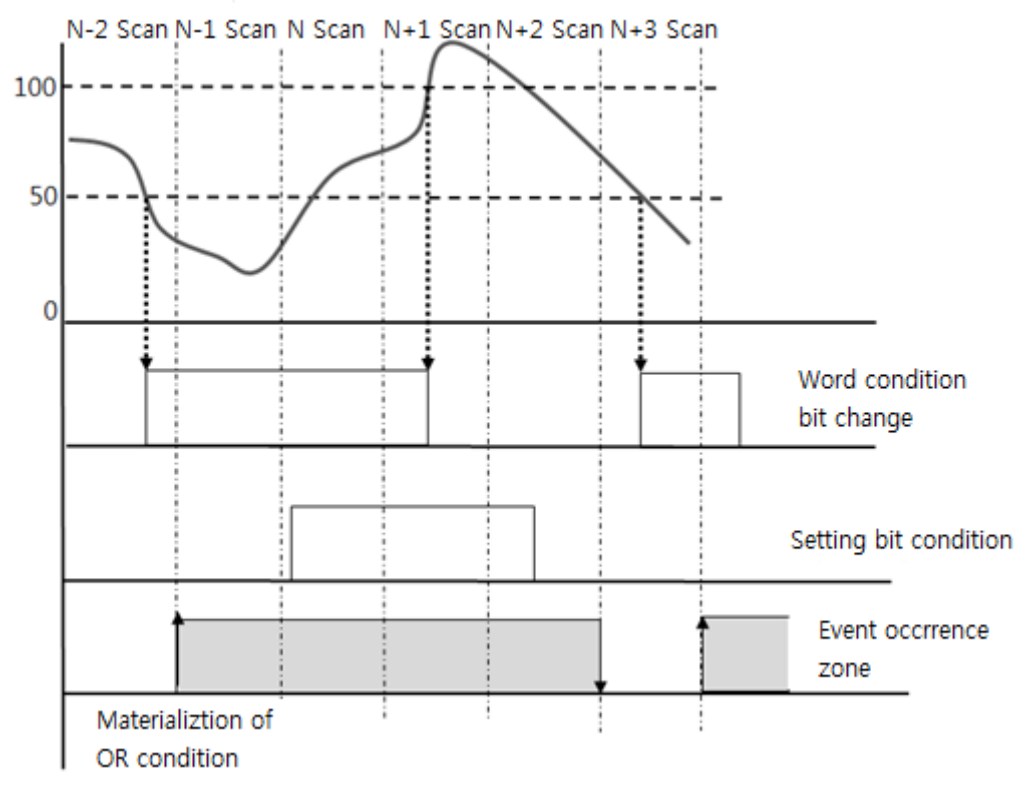

5.6.2 Setting Method

(1) Single BIT Condition

1) Choose XG5000 –[Project Window] - [internal parameter] - [data log]

This activates the data log parameter setting window.

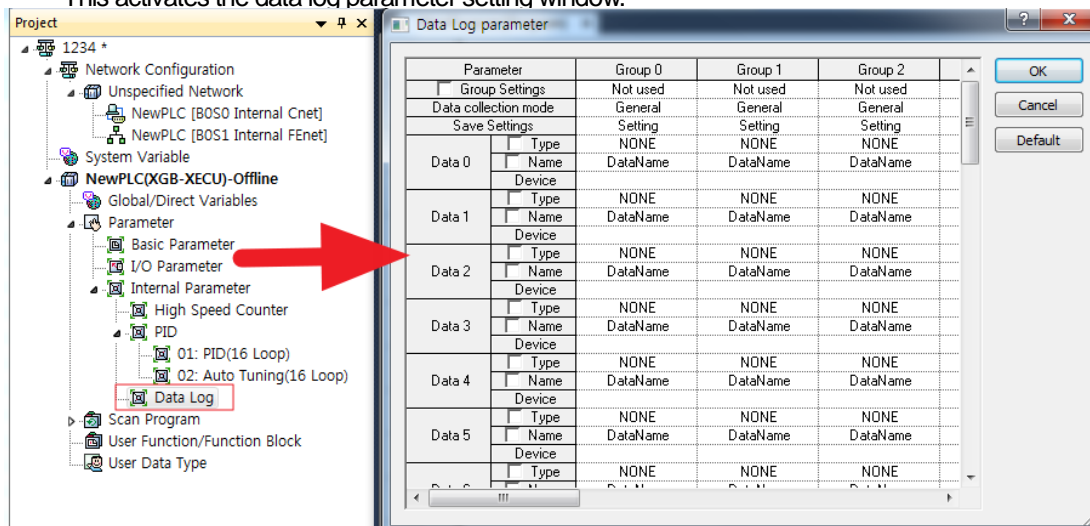

2) Set the group to use on the data log parameter window.

Parameter	Group 0
Group Settings	Not used
Data collection mode	General
Save Settings	Setting

Parameter	Group 0
Group Settings	Used
Data collection mode	General
Save Settings	Setting

3) Select [Event Logging] at [Data Collection Method] to activate [Setting] menu on the left.
Then, select the [Setting] menu on the left.

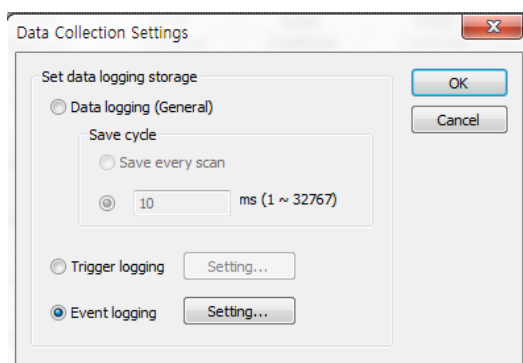

- 4) Upon selection, the following window is activated for event setting.
Select [Single Condition] as the Event Condition.

The 'Event settings' dialog box is shown with the following configuration:

- Event condition: Single, Combination
- E-mail settings: Don't send E-mail, Send E-mail
- Mail address: [Empty text box]
- Message: [Empty text area]
- Type: Information
- Event occurrence condition: Rising, Falling, Transition, On, Off
- Combination condition: AND, OR
- Target Device table:

	Device	Type	Condition
1			
2			
3			
4			

- 5) Select the condition setting menu to activate the following setting window.
Select [BIT Condition], and input device values into the device window in BIT types.

The 'Event settings' dialog box is shown with the following configuration:

- Conditions set: Bit condition, Word condition
- Device: %MX100
- Word condition: Device: [Empty text box], < [Empty dropdown], 0 Set Value
- Using Recovery: Using Recovery, 0 Cancel Value

When setting is complete, the window closes and the conditions initially set at the Event Setting Condition menu are displayed as follows.

The 'Event settings' dialog box is shown with the following configuration:

- Event condition: Single, Combination
- E-mail settings: Don't send E-mail, Send E-mail
- Mail address: [Empty text box]
- Message: [Empty text area]
- Type: Information
- Event occurrence condition: Rising, Falling, Transition, On, Off
- Combination condition: AND, OR
- Target Device table:

	Device	Type	Condition
1	%MX100	BIT	0
2			
3			
4			

- 6) Select the timing of data saving at the Event Occurrence Condition. The number and timing of data change depending on the set value.

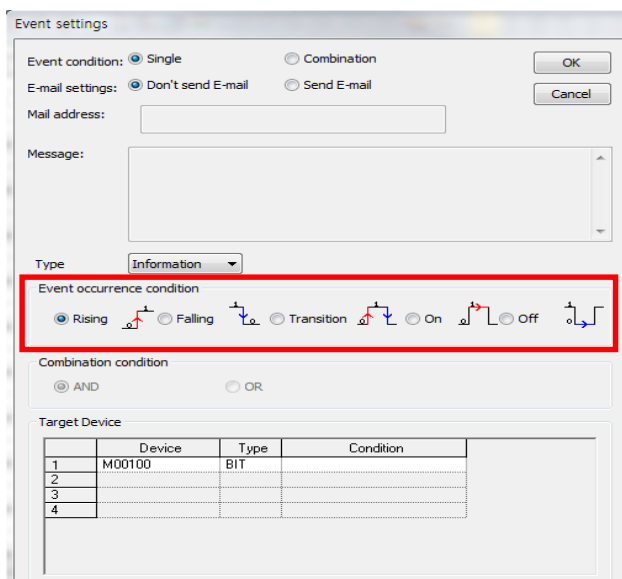

- 7) Mail Transmission allows the user to receive the relevant information via e-mail. Select [Mail Transmission] to enable the mail address box.

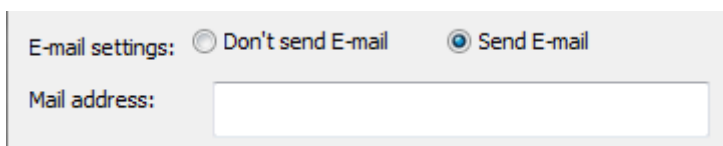

A mail address can be as long as 64 characters (English). A warning window will be activated if the mail address format is not complied with.

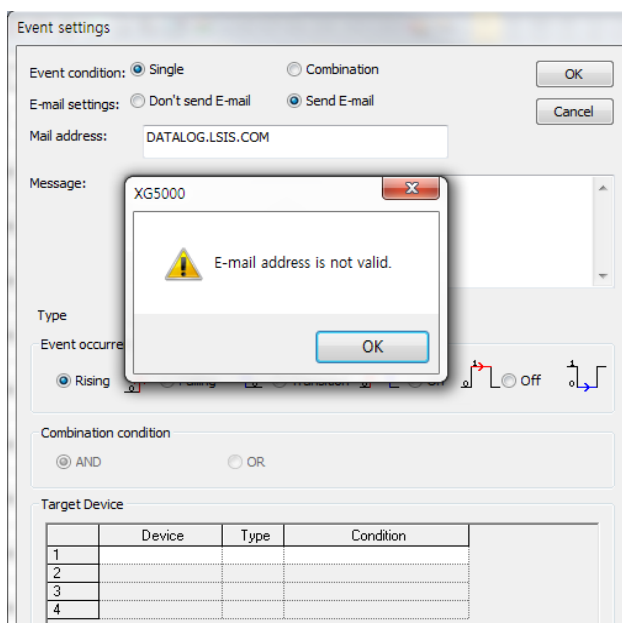

Single WORD Condition

- 1) Choose XG5000 –[Project Window] - [internal parameter] - [data log]

This activates the data log parameter setting window.

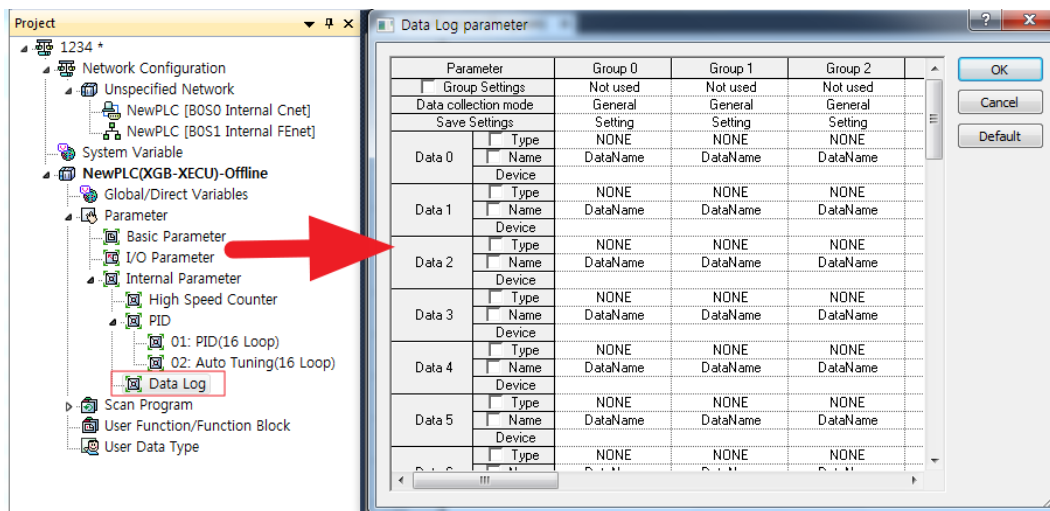

- 2) Set the group to use on the data log parameter window.



- 3) Select [Event Logging] at [Data Collection Method] to activate [Setting] menu on the left. Then, select the [Setting] menu on the left.

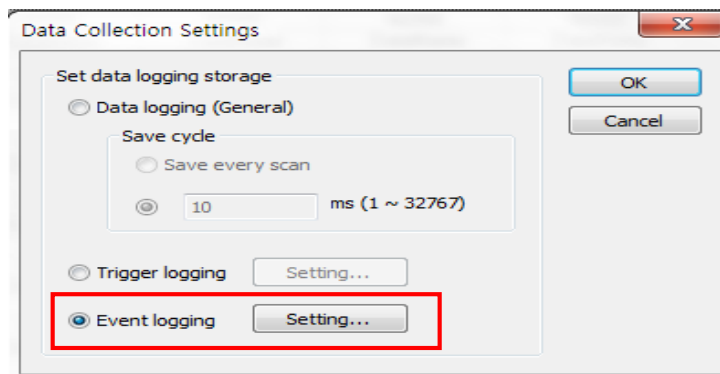

- 4) Upon selection, the following window is activated for event setting.
Select [Single Condition] as the Event Condition.

Event settings

Event condition: Single Combination

E-mail settings: Don't send E-mail Send E-mail

Mail address:

Message:

Type: Information

Event occurrence condition

Rising Falling Transition On Off

Combination condition

AND OR

Target Device

	Device	Type	Condition
1			
2			
3			
4			

- 5) Select the condition setting menu to activate the following setting window.
Select [WORD Condition], and input device values into the device window in BIT types.

Event settings

Conditions set

Bit condition

Device:

Word condition

Device: %MW100 < 100 Set Value

Using Recovery Cancel Value

OK Cancel

When setting is complete, the window closes and the conditions initially set at the Event Setting Condition menu are displayed as follows.

Event settings

Event condition: Single Combination

E-mail settings: Don't send E-mail Send E-mail

Mail address:

Message:

Type: Information

Event occurrence condition

Rising Falling Transition On Off

Combination condition

AND OR

Target Device

	Device	Type	Condition
1	%MW100	WORD	< 100, 0: Not used
2			
3			
4			

- 6) Select the timing of data saving at the Event Occurrence Condition. The number and timing of data change depending on the set value.

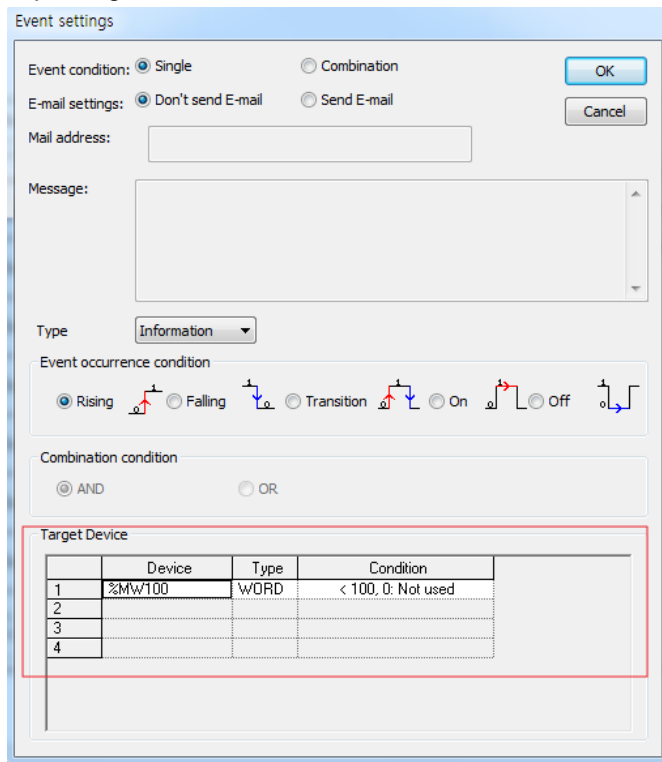

- 7) Mail Transmission allows the user to receive the relevant information via e-mail. Select [Mail Transmission] to enable the mail address box.

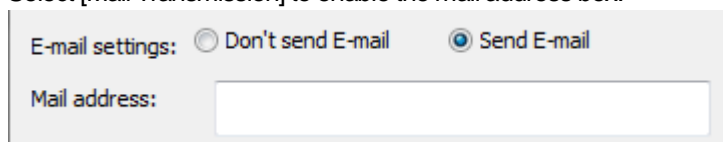

A mail address can be as long as 64 characters (English). A warning window will be activated if the mail address format is not complied with.

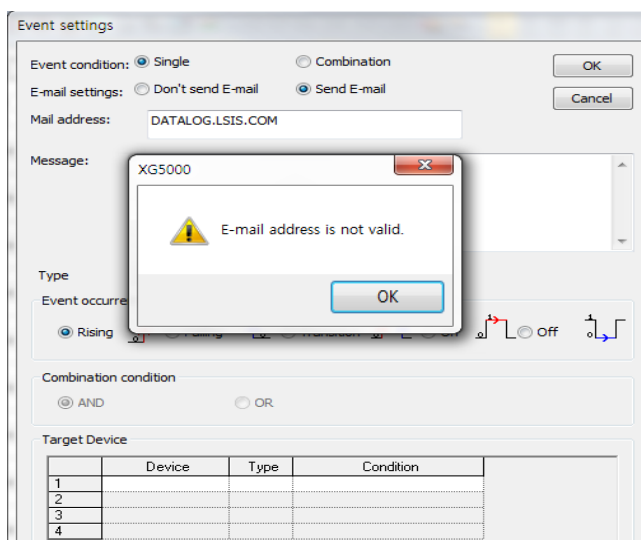

Multiple AND Condition

- 1) Choose XG5000 –[Project Window] - [internal parameter] - [data log]

This activates the data log parameter setting window.

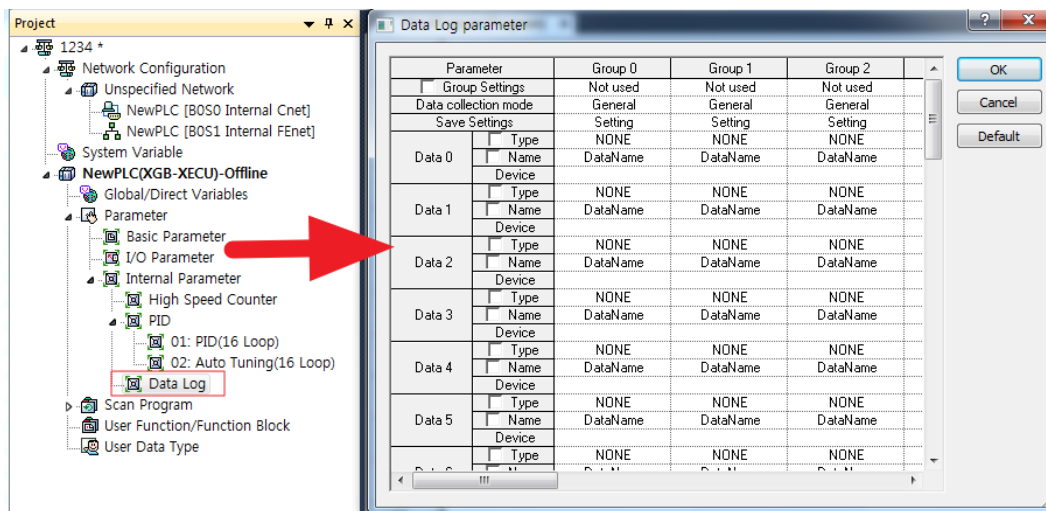

- 2) Set the group to use on the data log parameter window.



- 3) Select [Event Logging] at [Data Collection Method] to activate [Setting] menu on the left. Then, select the [Setting] menu on the left.

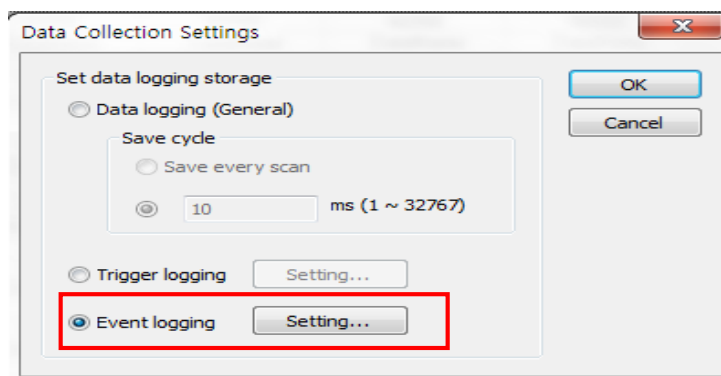

- 4) Select [Event Condition] and [Multiple Condition] to activate the condition setting window which allows for up to 4 inputs.

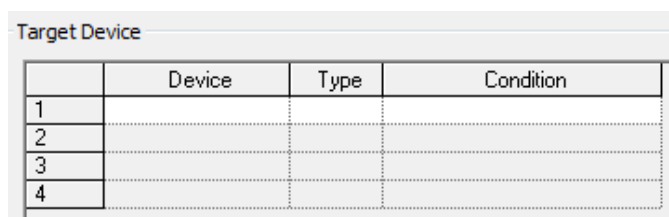

- 5)

- 5) Select the timing of data saving at the Event Occurrence Condition. The number and timing of data change depending on the set value.

Event settings

Event condition: Single Combination

E-mail settings: Don't send E-mail Send E-mail

Mail address:

Message:

Type: Information

Event occurrence condition

Rising Falling Transition On Off

Combination condition

AND OR

Target Device

	Device	Type	Condition
1	%Mw100	WORD	< 100, 0: Not used
2	%Mx15	BOOL	
3			
4			

- 6) Select each condition setting menu one by one, inputting specific set values. [Multiple Condition] activates Event Condition by calculating [Single Conditions] using the set run method. The basic setting is performed in the same way as Single Condition.

Event settings

Conditions set

Bit condition

Device: %Mx100

Word condition

Device: < 100 Set Value

Using Recovery 0 Cancel Value

OK Cancel

Event settings

Conditions set

Bit condition

Device:

Word condition

Device: %Mw100 < 100 Set Value

Using Recovery 0 Cancel Value

OK Cancel

- 7) When setting is complete, the window closes and the conditions initially set at the Event Setting Condition menu are displayed as follows.

The 'Event settings' dialog box is shown with the following configuration:

- Event condition: Single, Combination
- E-mail settings: Don't send E-mail, Send E-mail
- Mail address: [Empty text box]
- Message: [Empty text area]
- Type: Information
- Event occurrence condition: Rising, Falling, Transition, On, Off
- Combination condition: AND, OR
- Target Device table:

	Device	Type	Condition
1	%MW100	WORD	< 100, 0: Not used
2	%MX15	BOOL	
3			
4			

If only one [Condition Setting] is input after selecting Calculation Condition before finishing the setting, the following phrase is displayed and the setting is not complete.

The 'Event settings' dialog box is shown with an error message overlay. The configuration is as follows:

- Event condition: Single, Combination
- E-mail settings: Don't send E-mail, Send E-mail
- Mail address: [Empty text box]
- Message: [Empty text area]
- Event occurrence condition: [Not visible]
- Combination condition: [Not visible]
- Target Device table:

	Device	Type	Condition
1	M00100	BIT	
2			
3			
4			

The error message box (XG5000) contains the following text:

! If the combination is selected, the conditions set must have at least two entries.

Multiple OR Condition

- 1) The same sequence as [AND Calculation Condition] applies up to the [Event Setting] menu.
- 2) Select [Event Logging] at [Data Collection Method] to activate [Setting] menu on the left. Then, select the [Setting] menu on the left.

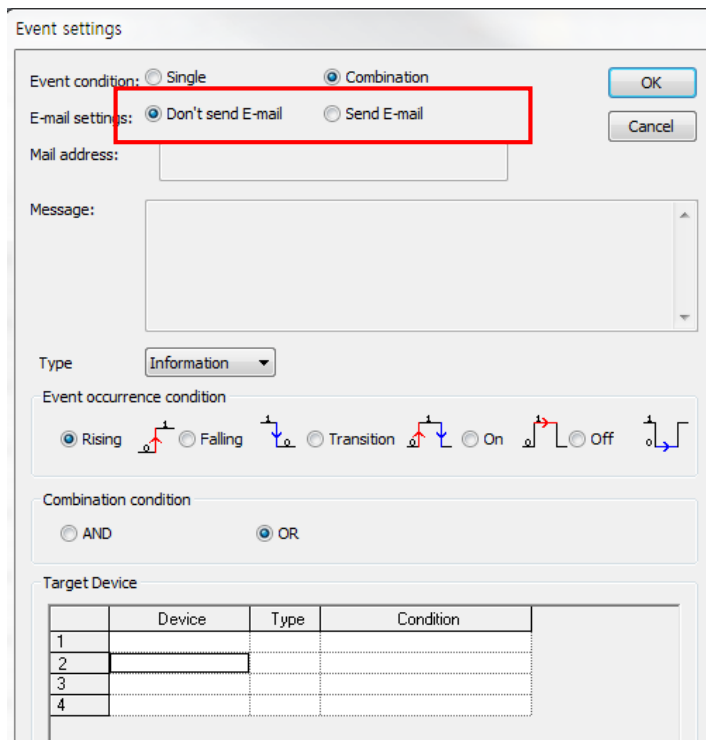
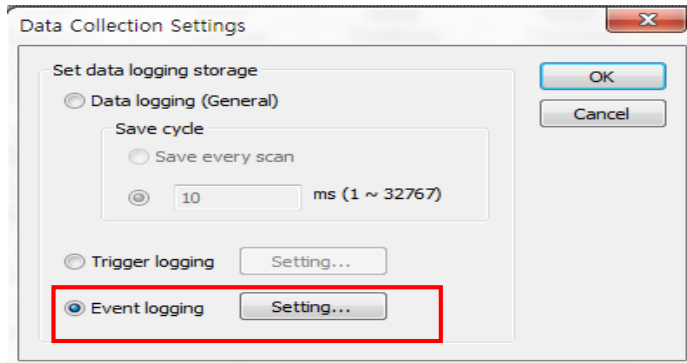

- 3) Select [Event Condition] and [Multiple Condition] to activate the condition setting window which allows for up to 4 inputs.

	Device	Type	Condition
1			
2			
3			
4			

- 4) Select the timing of data saving at the Event Occurrence Condition. The number and timing of data change depending on the set value.

Event settings

Event condition: Single Combination

E-mail settings: Don't send E-mail Send E-mail

Mail address:

Message:

Type: Information

Event occurrence condition

Rising Falling Transition On Off

Combination condition

AND OR

Target Device

	Device	Type	Condition
1			
2			
3			
4			

- 5) Select each condition setting menu one by one, inputting specific set values. [Multiple Condition] activates Event Condition by calculating [Single Conditions] using the set run method. The basic setting is performed in the same way as Single Condition.

Event settings

Conditions set

Bit condition

Device: MX100

Word condition

Device: %MW100 < 100 Set Value

Using Recovery 0 Cancel Value

OK Cancel

Event settings

Conditions set

Bit condition

Device:

Word condition

Device: %MW100 < 100 Set Value

Using Recovery 0 Cancel Value

OK Cancel

- 6) When setting is complete, the window closes and the conditions initially set at the Event Setting Condition menu are displayed as follows.

	Device	Type	Condition
1	%Mw100	WORD	< 100, 0: Not used
2	%Mx15	BOOL	
3			
4			

If only one [Condition Setting] is input after selecting Calculation Condition before finishing the setting, the following phrase is displayed and the setting is not complete.

	Device	Type	Condition
1	%Mw100	WORD	< 100, 0: Not used
2			
3			
4			

5.7 Additional Functions

This section provides detailed description of additional functions of internal data log

5.7.1 File Save History Setting

When the maximum number of files are saved into the data log, file save changes depending on whether [Overwrite with Latest History] or [Maintain First History] is chosen at the [History Setting]

Overwrite with the latest history

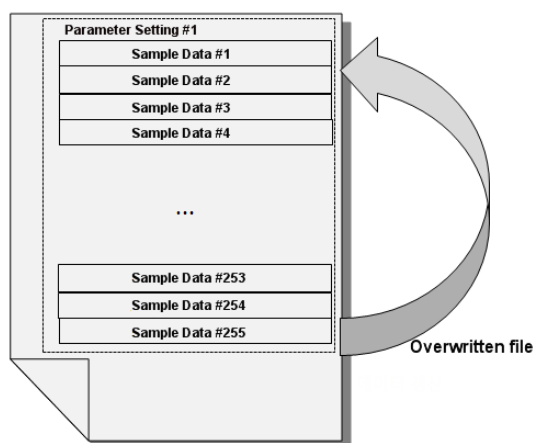

☞ Saves data in the maximum number of saved files (256 files/folder), and then goes back to the beginning to delete old files, and save the latest history.

☞ When the maximum files are saved after selecting [Overwrite with Latest History], the file save excess flag value increases. (See 5.10, Flag List)

☞ If the 10% or less of the SD memory storage is free, the data are written over the file first saved.

☞ The overwritten file has the same size as the previous one.

Maintains the initial history

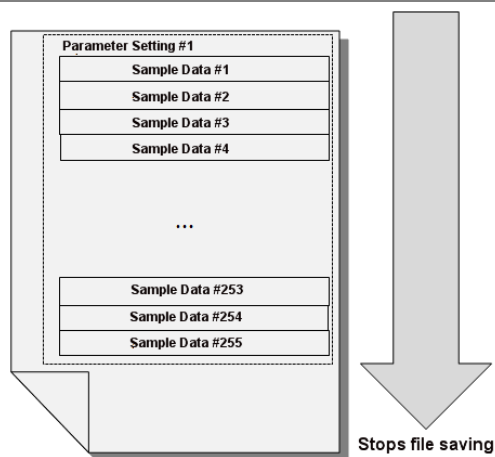

☞ Saves data in the maximum number of saved files (256 files/folder), and then stops file saving.

☞ If the 10% or less of the SD memory storage is free, stops file saving.

Setting Method

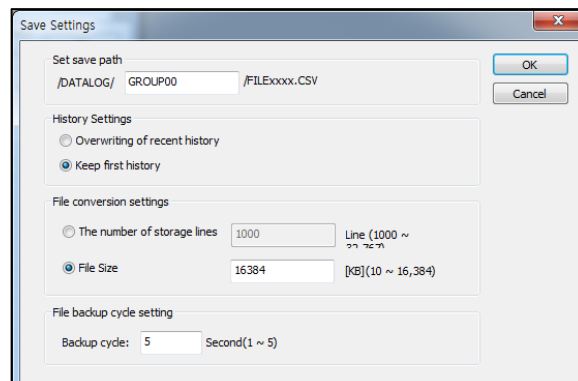
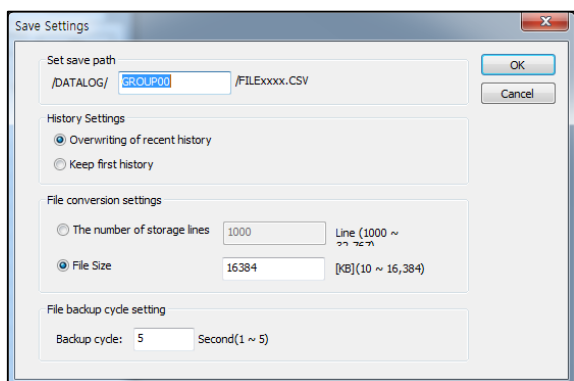

Caution

Do not change data log parameter if file is overwritten after selecting [Overwrite the latest history]

Changing the parameter changes the data save format, causing error.

If error occurs after change, perform formatting using the SD memory.

5.7.2 E-mail Transmission

Internal data log allows for receiving information at the pre-entered E-mail address when the event set at [Event Save] occurs. The E-mail address should comply with the e-mail address format, and can be as long as 64 characters (English)
Upon Event Occurrence The transmitted information consists of the following.



Please make sure to select [Send E-mail] at the [Event Settings] parameter setting window.

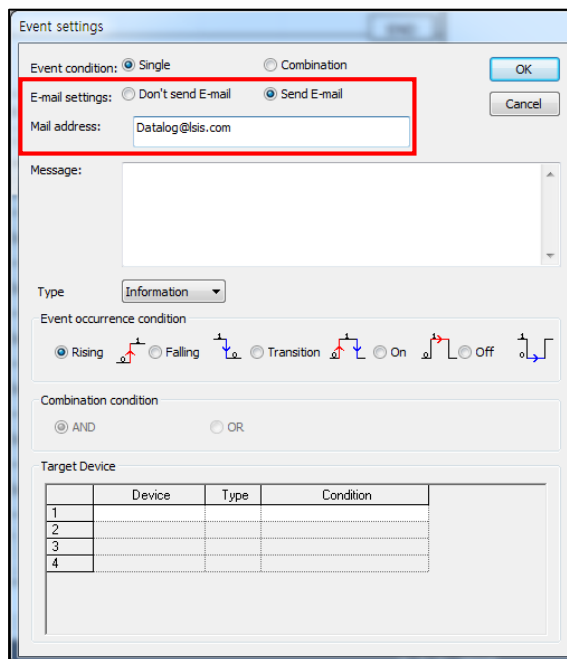

Caution

If an event occurs again while sending an e-mail, mail transmission for the second event is not performed.
Mail transmission is done after the first mail transmission.

5.7.3 Formatting Function

Internal data log supports SD memory formatting function. SD memory formatting is done through XG5000. SD memory formatting is supported only when PLC is in STOP mode.

(1) Formatting Specifications

The SD memory formatting supported by data log has the following specifications.

Item	Set Specifications
File System ¹⁾	FAT32
Supported SD memory Capacity ²⁾	2GByte ~ 16GByte
Allotted Cluster Size ³⁾	4096Byte (512 Sector ⁵⁾ * 8) 8192Byte (for 16G)
Volume Label ⁴⁾	LS (fixed)
PLC Operation Mode ⁶⁾	STOP (REMOTE available)
Formatting Mode ⁷⁾	Fast Formatting

- 1) File System: Rules of Saving Files into Disk
- 2) Supported SD memory Capacity: MMC card not supported, 2GByte~ 16GByte SD memory supported (SD, SDHC supported)
Micro SD not supported.
- 3) Allotted Cluster Size: Minimum Unit for File Saving
- 4) Sector: Minimum Unit for Data Saving (Default: 512 Byte)
- 5) Volume Label: SD memory Card Name
- 6) PLC Operation Mode: Operates only in STOP mode
- 7) Formatting Mode: Fast-formats the SD memory Only deletes the FAT and directory area within the file system.

Note

When performing [Formatting Function] at PLC, all contents within the SD memory are deleted, followed by creation of a folder with the name set by the parameter.

(2) Execution

- 1) Select XG5000 –[On-line] –[Reset/Clear] – [SD Memory] –[Format]

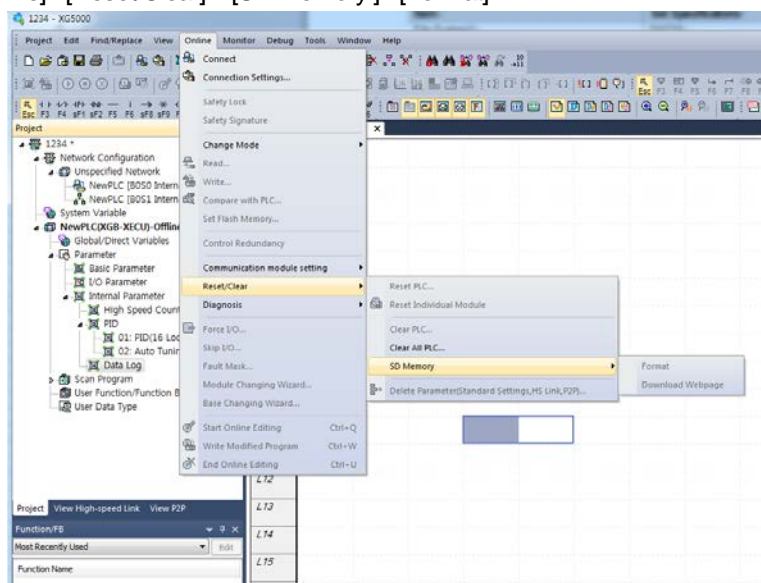

- 2) Before executing SD memory formatting, cautions for formatting process are activated..
After reviewing the cautions, press [Yes] to proceed to the next stage.

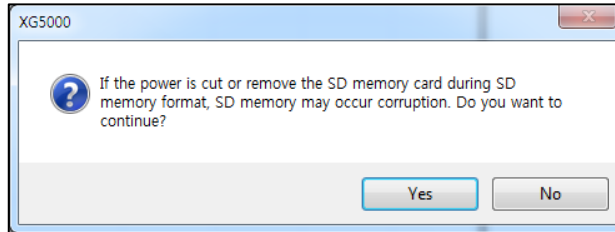

Caution

Detaching the SD memory with force, power off or reset during formatting may cause internal damage of the connected card, which may not show normal run afterwards.

- 3) Subsequently the formatting setting window is activated. The setting window is as follows.
The storage, file system and allotted unit size are Default values that are read when connecting the SD memory. Also, only fast formatting is supported. Volume label should be in English, and can be as long as 10 characters.. After setting as indicated above, press [Start] to begin formatting. The status bar indicates the current progress.

Ex) when a 8G memory is connected

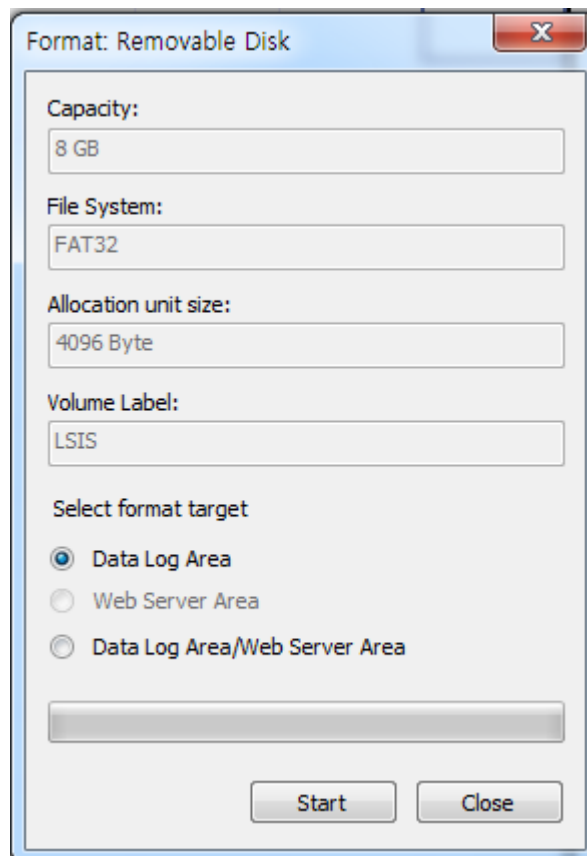

(3) Formatting Complete and Error Codes

1) Status Information

F Area Address	Flag Name	Description
%FW0032	_SD_FMT_INFO	SD memory formatting information
BIT	%FX0512	_SD_FMT_RUN
	%FX0513	_SD_FMT_DONE
	%FX0514	_SD_FMT_NG
%FW0033	_SD_FMT_ECODE	SD memory formatting error codes

2) Error Code

Error Code	Error Name	Error Description
0x0001	SD Detachment	When the SD memory card is forcibly removed during SD memory formatting
0x0002	File System Damage	When the file system is damaged during SD memory formatting
0x0003	PLC Mode Change	When PLC run mode is changed during SD memory formatting

2) Completion Phrase

FOO321 Bit turns ON when formatting is complete. In this case, the following completion window appears.

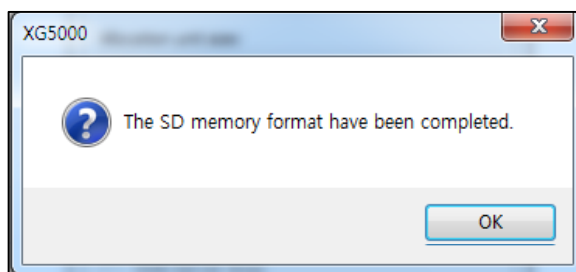

If formatting failed, an error window appears along with the relevant code.

SD Detachment	File System Damage
PLC Mode Change	

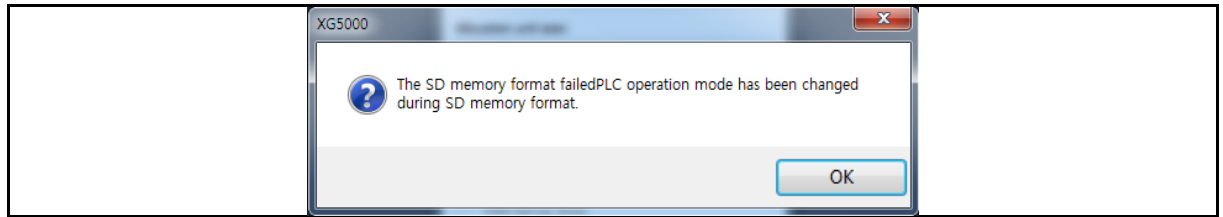

5.7.4 Diagnosis Function

Data log provides SD memory diagnosis function.

SD memories that do not comply with the following cannot be used. Data log function will not be executed when such memories are connected.

(1) FAT32 File System Diagnosis

- ☞ The memory should be formatted using the FAT32 format, to allow for file saving. Files will not be saved if it is formatted using other formats.

(2) SD Memory Internal Data Diagnosis

- ☞ When a memory used in another data log module is connected, the system compares the data in the file, and regards it as a different memory if the data do not match. In this case, file save does not progress further. When this happens, format the memory before connecting it.

(3) SD Memory LOCK Status Check

- ☞ If the lock slide switch on the top left side of the SD memory is set to Lock, an error occurs when connecting the SD memory for the first time and the data log function does not run.

(4) Memory Diagnosis after Power On/Off

- ☞ In case a sudden power off or reset stops data saving into the SD memory while data log is running, the system diagnoses the file system and then proceeds with file diagnosis for data log execution. The time required increases as the number of folders and files increase, up to 15 seconds. During this time, the data log function cannot be used.

Caution

Since sudden power off may cause file system / file damage or saving of abnormal data.

Therefore, make sure to execute STOP flag or PLC STOP when trying to stop data log function, so as to ensure normal data saving.

5.8 CSV File Structure

5.8.1 File Save Format

The name of CSV files are created in the following form.

Name	F	I	L	E	0	0	0	0	.CSV
Description	File Name				Group Number	File Number			Extension
Range	Fixed Value				0~9	000 ~ 255			Fixed Value

The first 3 characters are fixed as 'FILE,' and the 4th number indicates the group number selected, and the following 5~8th numbers indicate the file number.

For example, the 8th file of the 7th group will be named 'FILE7008.CSV.'

5.8.2 File Name and Save Sequence

When executing data log function after selecting a certain group, the file sequence progresses from Number 0. When executing data log function on multiple groups, files are first created for Group 0, and progresses sequentially to Group 9. Selecting [Do Not Use] at the [Group Setting] will stop file saving in the current group, and files creating will move into the next group.

Group Name	Group 0	Group 1	Group 2	Group 3	Group 4	Group 5	...	Group 9
File Name and Creation Sequence	LOG0000	LOG1000	LOG2000	LOG3000	LOG4000	LOG5000		LOG9000
	LOG0255	LOG1255	LOG2255	LOG3255	LOG4255	LOG5255		LOG9255

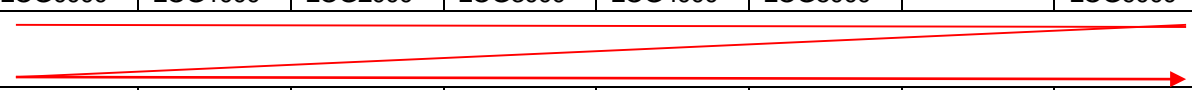

Note

While the data value collected from PLC is saved at the interval set by the parameter, saving into the SD memory is performed using Scan Save method, starting from Group 0.

5.8.3 Parameter Change during File Saving

During data log function run, parameter can be changed under the following conditions.

- ☞ Files are saved into the SD memory for the first time (Rollover-Cnt is 0)
- ☞ The set data type and number are the same

Changing the parameter under the above conditions will not perform a separate file conversion: files are saved after the existing saved files.

Setting	Save Data					Parameter	
		A	B	C	D	E	
First Parameter	1	Remark	Project =NewPLC				<ul style="list-style-type: none"> ➤ Data TypeLINT ➤ No. of Settings1 ➤ Save Method: Regular Save ➤ History Setting: Overwrite with the latest history ➤ File Conversion Point: File Size: 100KB
	2	Remark	Filename =FILE0000.CSV				
	3	Remark	Start Date =2004/02/27/03:54:02.738				
	4	Remark	PLC Type =XGB-XBCU				
	5	Remark	LogType =Normal				
	6	Remark	DataType LINT				
	7						
	8	TIME	INDEX	DataName			
	9	2004/02/27/03:54:02.738	0	62567			
	10	2004/02/27/03:54:02.748	1	62607			
	11	2004/02/27/03:54:02.758	2	62652			
	12	2004/02/27/03:54:02.768	3	62696			
Change Parameter	17	2004/02/27/03:54:02.818	8	62913			<ul style="list-style-type: none"> ➤ Data TypeLINT ➤ No. of Settings1 ➤ Save Method: Regular Save ➤ History Setting: Overwrite with the first history ➤ File Conversion Point: File Size: 100KB
	18	2004/02/27/03:54:02.828	9	62959			
	19	2004/02/27/03:54:02.838	10	63003			
	20	2004/02/27/03:54:02.848	11	63049			
	21	2004/02/27/03:54:02.858	12	63094			
	22	2004/02/27/03:54:02.868	13	63139			
	23	2004/02/27/03:54:02.878	14	63184			
	24	2004/02/27/03:54:02.888	15	63230			
25	2004/02/27/03:54:02.898	16	63275				

Caution

Data log error flag occurs if the conditions for parameter change are not satisfied, and file saving stops.

5.9 SD Memory Card

5.9.1 SD Memory Specifications

To use data log function, the SD memory used should satisfy the following specifications.

Items	Description
Memory Capacity:	Up to 16 GB (supports SPI MODE, SD, SDHC)
File System	FAT32
Voltage Range	2.7 ~ 3.6V
Working Temperature Range	-25°C ~ 85°C
Static Tolerance	Should satisfy IEC61000-4-2
Number of Detachments	Up to 10,000 times
Current Consumption	Up to 100mA (when reading, writing)
Number of Read/Writes	Up to 100,000 times (for SLC)
Size	32mm * 24mm * 2.1mm
Writing Prevention	Use the lock switch on the SD memory card
Recommended Products	SanDisk, Transcend

Note

Data log function of high-performance XGB is capable of using all SD memories that satisfy the specifications above.

Optimal performance can be expected by using the recommended products (SanDisk, Transcend).

Please use the recommended products unless required otherwise

5.9.2 SD Memory Part Names

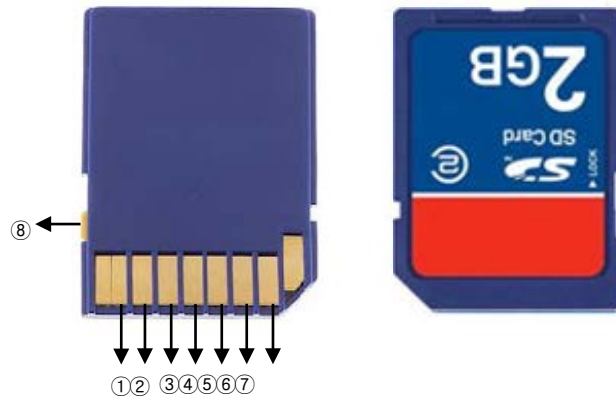

Number	Name	Description
①	DO	A signal line through which response data of the SD memory is transmitted upon request from PLC
②	VSS	Signal Ground
③	SCLK	Sync CLK signal of DO/DI signal
④	VCC	3.3V supply socket
⑤	VSS	Signal Ground
⑥	DI	A signal line through which the data requested by PLC is transmitted to the SD memory
⑦	CS	SD Memory Selection Signal Line
⑧	LOCK SW	Slide Lock

5.9.3 Caution

Please pay attention to the following when using data log function with SD memory card.

(1) Power Off during SD Memory Writing

- 1) Power off or PLC reset during writing of data collected by high-performance XGB into the SD memory may damage the file system of the memory card. Although PLC verifies the file system of the SD memory when applying electric power to convert the damaged files into usable files, such restoration may not be possible depending on the level of damage. When powering off PLC, please perform power off after verifying that the SD memory writing is not being performed.
- 2) Power off or PLC reset during writing of data collected by high-performance XGB into the SD memory causes all data saved in the buffer memory inside the buffer memory. Therefore, the data collected immediately before power off may not have been saved properly. When powering off PLC, please perform power off after verifying that the SD memory writing is not being performed.

(2) Time Required when Suspending SD Memory Writing

In cases of using K area flag to turn off the data log permission flag while data saving is in progress, all data collected before reception of the relevant flag command are saved into the SD memory, and then the data log operation stops. Therefore, a small time is required until the data log function actually stops. The stop progress can be verified using the STOP PROGRESS flag in K area. The time required for data log stop varies depending on the volume of data collected. When SD memory writing is complete, the data log STOP status flag value changes to 1.

(3) Removal of Memory Card during Read/Write in SD Memory

- 1) Forcibly removing the SD memory from PLC during writing or reading of data collected by high-performance XGB may damage the file system of the memory card. Therefore, please remove SD memory after disabling the data log function using the command flag. If SD memory is removed during read/write of the SD memory, the SD STATE LED flashes at 500ms interval.

The following figure shows the sequence of disconnecting or exchanging SD memory card.

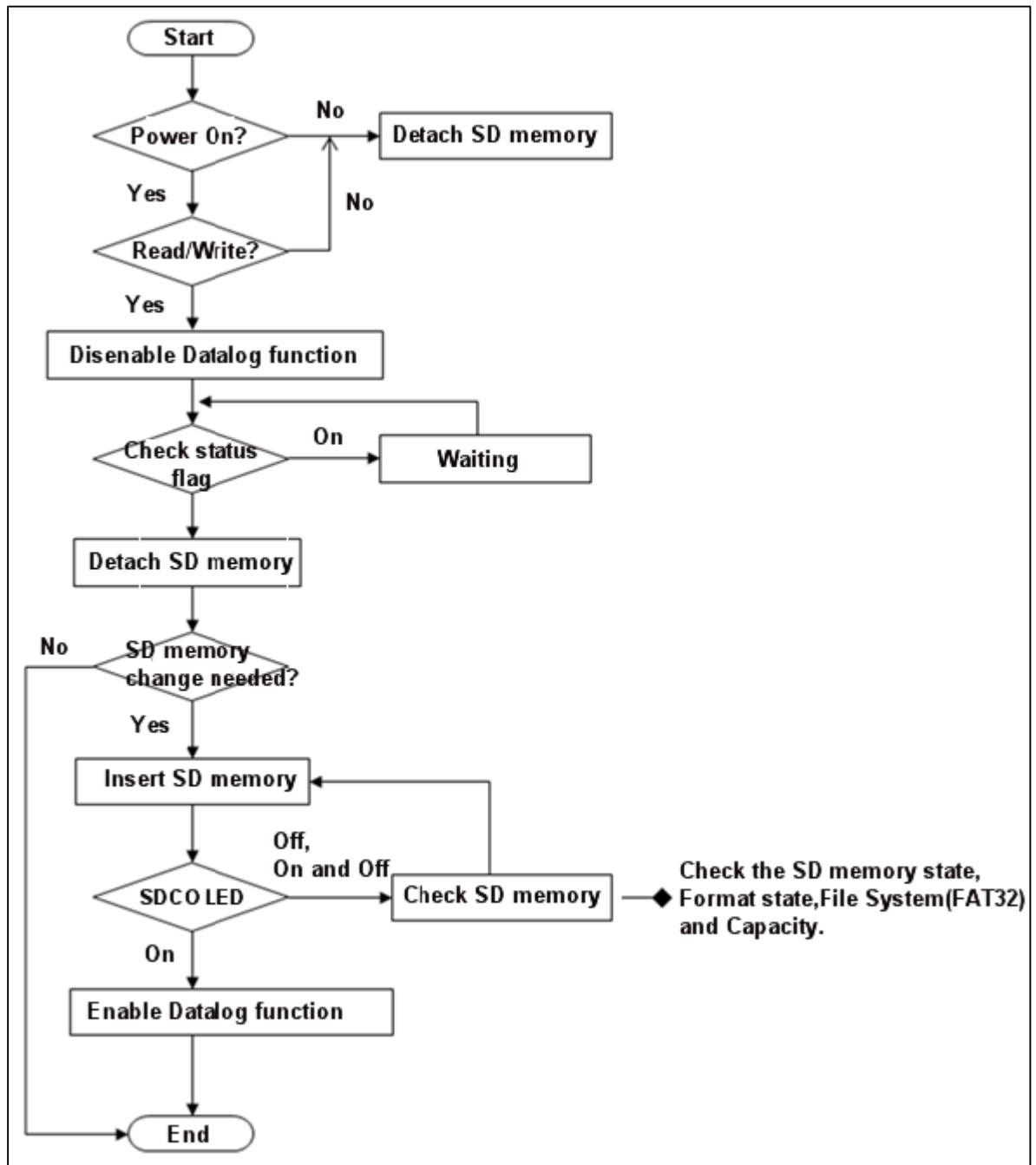

- 2) Power off or reset during data log run may cause abnormal data saving. Also, the file system may be damaged and not recognized the SD memory and the files. In cases of power off during data saving, the SD memory diagnosis function is activated, and other PLC functions are not performed during that time (approximately 15 seconds).

(4) Use of Cover to Prevent SD Memory Detachment

When connecting SD memory to the high-performance PLC, se the direction properly.

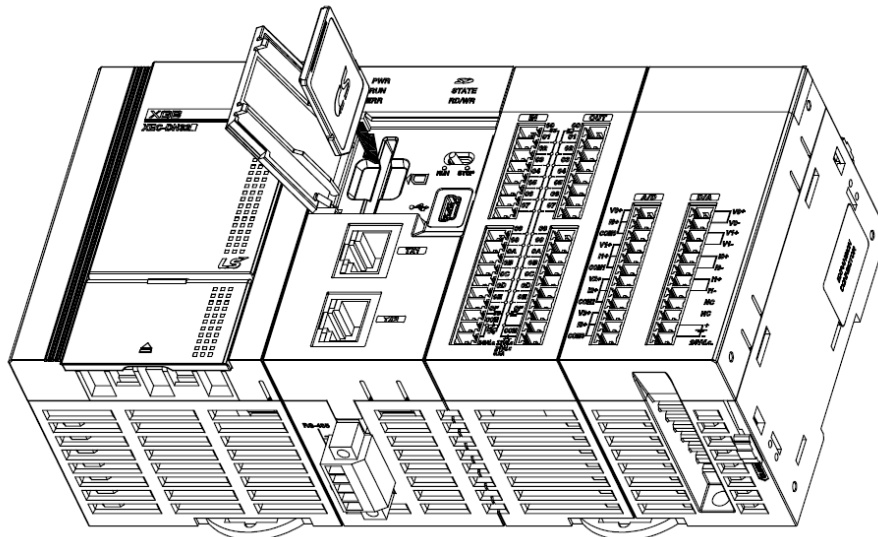

Also, please use a cover to prevent SD memory detachment due to vibration

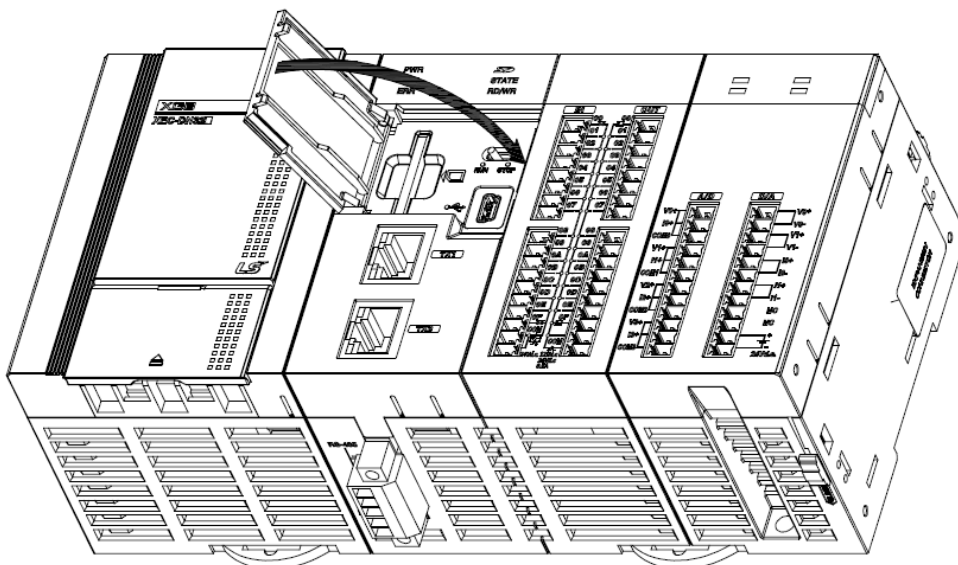

5.9.4 SD Memory Usage

Data log uses only 90% of the total storage of the connected memory. The purpose of this restriction is to reduce the time required for SD memory access

SD Memory Capacity (Actual Capacity)	Capacity Used by Data Log
2G (1.83G)	About 1.5GByte
4G (3.76G)	About 3.3GByte
8G (7.39G)	About 6.6GByte
16G (14.8G)	About 13.2GByte

Note

SD memory state may affect scan time and saving performance. SD memory should be formatted before use. When using the SD memory for a long time, formatting on a regular basis is required to maintain performance.

5.10 Flag List

5.10.1 Common Flag

Address	Data Type	Variable	Function	Description
%KW4000	WORD	_DL_En	Data Log Setting	Data Log Setting Flag : Sets the BIT that corresponds to the set group Ex) Group 3 in use → Bit 3 ON Group 3 not in use → Bit 3 OFF
%KX64016	BIT	_DL_RDY	Data Log Ready State	Indicates SD memory availability
%KX64017	BIT	_DL_SD_Detect	SD Memory Mounting State	Indicates SD memory mounting state
%KW4002	WORD	_DL_SD_StorageSize (GB)	SD Memory Capacity:	Capacity of the SD memory connected
%KW4003	WORD	_DL_SD_Cluster	SD Cluster Size	SD Cluster Size
%KD2002	DWORD	_DL_SD_RemainVolume (KB)	Remaining SD memory storage	Remaining SD memory storage (KB)
%KW4006	WORD	_DL_Err_Code	Common Error Code	Common error code for the overall data log functions
%KW4007 ~ %KW4019		RESERVED		

5.10.2 Group-specific Flag

(1) Parameter Group 0 Flag

Address	Data Type	Variable	Function	Description
%KX64000	BIT	_DL_0_Group_En	Sets the Group 0 data log	Data Log Setting Flag 0: Stop, 1: Save Setting
%KX64320	BIT	_DL_0_Log_Run	Group 0 Data Log Operation Bit	Data log save progress 0: Stop, 1: Saving
%KX64321	BIT	_DL_0_Log_Ending	Group 0 Data Log STOP Progress Bit	Data Log Stop State 0: Stop, 1:STOP
%KX64322	BIT	_DL_0_Log_Err	Group 0 Data Log Error Bit	Data Log Error Bit 0: No Error, 1: Error Occurred
%KX64323	BIT	_DL_0_Data_Clash	Group 0 Data Clash State	Data Clash State 0: No Clash, 1: Clash
%KW4021	WORD	_DL_0_Err_Code	Group 0 Error Code	Error Code
%KW4022	WORD	_DL_0_File_Index	Group 0 Save File Index	Save File Index Range :0~255
%KW4023	WORD	_DL_0_File_Overwrite_Cnt	Group 0 File Overwrite Count	File Overwrite Count

%KD2012	DWORD	_DL_0_File_Pointer	Group 0 File Files Save Pointer	File Save Size : The first created file has the same size as the saved file. After rollover, the size is the same as that of the previously saved file.
%KD2013	DWORD	_DL_0_Data_Index	Group 0 Data Index	Saved File Index Info Range :0~999,999,999
%KW4028	WORD	_DL_0_DL_Stop_Progress (%)	Group 0 Data Log STOP Progress	Data Log STOP Progress : Indicates the progress until data saving stops Range: 0~100 (%)
%KW4029	WORD	_DL_0_Data_Clash_Cnt	Group 0 Data Clash Count	Number of data clashes, number of data dump due to buffer overflow
%KX64480	BIT	_DL_0_Trig_State	Group 0 Trigger Condition Occurrence State	Trigger Condition Occurrence State 0: Stop, 1: Running
%KW4031	WORD	_DL_0_Trig_Cnt	Group 0 Trigger Condition Occurrence State	Trigger Condition Occurrence State
%KW4032	WORD	_DL_0_Trig_ReCnt	Group 0 Trigger Condition Reoccurrence Count	Count of ignoring triggers that reoccurred before Trigger Save is complete
%KX64528	BIT	_DL_0_Evt_State	Group 0 Trigger Event Condition Occurrence State	Trigger Event Condition Occurrence State 0: Stop, 1: Running
%KW4034	WORD	_DL_0_Evt_Cnt	Group 0 Event Condition Occurrence Count	Event Condition Occurrence Count
%KW4035 ~ %KW4039		RESERVED		

(2) Parameter Group 2~9 Flag

Address	Size	Variable	Function	Description
%KW4040	20Word	-	-	Parameter of Group 1 (Structure identical to Group 0)
%KW4060	20Word	-	-	Parameter of Group 2 (Structure identical to Group 0)
%KW4080	20Word	-	-	Parameter of Group 3 (Structure identical to Group 0)
%KW4100	20Word	-	-	Parameter of Group 4 (Structure identical to Group 0)
%KW4120	20Word	-	-	Parameter of Group 5 (Structure identical to Group 0)
%KW4140	20Word	-	-	Parameter of Group 6 (Structure identical to Group 0)
%KW4160	20Word	-	-	Parameter of Group 7 (Structure identical to Group 0)
%KW4180	20Word	-	-	Parameter of Group 8 (Structure identical to Group 0)
%KW4200	20Word	-	-	Parameter of Group 9 (Structure identical to Group 0)

5.10.3 Error Code and Solution

Error codes related to data log function is as follows.

Items	Error Code	Error Name	Solution	Note
Overall Error Codes	0x0000	No Error	-	
	0x0001	Parameter Error	Please check the data log parameter setting. Parameter errors are indicated as errors also in the group where they occurred, and subsequent groups are not checked. (‘Use’ setting is selected but the set data do not exist; ‘Trigger’ setting is selected and trigger is not allowed or no condition is set; ‘Event’ setting is selected and event is not allowed or no condition is set)	
	0x0002	SD card locked	Please check the LOCK switch on the right side of SD card	
	0x0003	File System Error	Format in FAT32 format and connect SD memory.	
	0x0004	Connect other SD Card	Format in FAT32 format and connect SD memory.	
	0x0005	SD Card Not Supported	Please connect SD Card with storage of 2GB~16GB.	
	0x000A	SD Card Capacity Exceeded	SD memory storage is fully used, and data cannot be saved. Please replace SD memory or format the memory before reconnecting. Available storage is less than 20%	
	0x000C	Shut Down Error	Power off may lead to data loss. If data is not saved, it means the file system inside the SD memory is damaged. Please format the memory before use. Power off before STOP	
	0x0010	DATALOG Folder Comparison Error	Format in FAT32 format and connect SD memory. (Another folder exists apart from “DATALOG” folder)	
	0x0011	Group Folder Comparison Error	Format in FAT32 format and connect SD memory. (Folder of another group than the parameter exists)	
	0x0020	Sector Error	Format in FAT32 format and connect SD memory.	
	0x0030	SD memory detached	Format in FAT32 format and connect SD memory.	
	0x00A0	Boot Sector Damaged	The boot sector inside the SD memory is damaged. Format before reconnecting, or replace the memory.	
	0x00B0	DIR Entry Damage	The DIR information inside the SD memory is damaged. Format before reconnecting, or replace the memory.	
	0x00C0	FAT Entry Damage	The FAT information inside the SD memory is damaged. Format before reconnecting, or replace the memory.	
	0x00D0	Partition Information Error	The partition information inside the SD memory is damaged. Format before reconnecting, or replace the memory.	
	0x00F0	File System Mount Error	Although SD memory initialization process varies depending on the scan time, if the relevant error code persists, format the SD memory before reconnecting.	
	0x0015	SD Memory Storage Full:	SD memory storage is fully used, and data cannot be saved. Please replace SD memory or format the memory before reconnecting.	
	0x8000	Format Error	Please check the SD card for damage Please check power supply	

Group-specific Errors Code81 92Byte	0x0001	Group No. X Parameter Error	Please check the data log parameter setting. In case of parameter errors, subsequent groups are not checked, and it is indicated as error in the overall error code. (‘Use’ setting is selected but the set data do not exist; ‘Trigger’ setting is selected and trigger is not allowed or no condition is set; ‘Event’ setting is selected and event is not allowed or no condition is set)	
	0x0004	Group No. X Connect another SD card	Format in FAT32 format and connect SD memory. Group No. X parameter is different from the parameter information in the first saved file	
	0x000C	Shut Down Error	Power off may lead to data loss. If data is not saved, it means the file system inside the SD memory is damaged. Please format the memory before use. Power off before STOP	
	0x1000	Group No. X Folder Creation Error	Format in FAT32 format and connect SD memory.	
	0x2000	Group No. X File Open Error	Format in FAT32 format and connect SD memory.	
	0x3000	Group No. X File Save Location Search Error	Format in FAT32 format and connect SD memory.	
	0x4000	Group No. X File Write Error	Format in FAT32 format and connect SD memory.	
	0x5000	Group No. X File Flush Error	Format in FAT32 format and connect SD memory.	
	0x6000	Group No. X File Close Error	Format in FAT32 format and connect SD memory.	
	0x7000	Group No. X File Search Error	Format in FAT32 format and connect SD memory.	
0x9000	Group No. X File Rave Error	Format in FAT32 format and connect SD memory.		

5.11 Data Processing Time

This section describes the data storage time of data log function.

The processing times described in this section do not represent absolute values, but actual measurement of each example.

The actual processing time varies depending on the scan time, volume of collected data, format of the collected data, type and storage of SD memory and number of files in the SD memory.

5.11.1 Impact on Scan

Scan time fluctuates depending on the data log function parameters. Also, the time is affected by the SD memory connected.

The following measurements were taken using memories made by SanD, Transcent

Scan Time Variation = within 30% of max scan time (when scan time is 10ms or longer)

Ex 1) In case of setting data log for a 1ms scan program, the scan time may increase up to 6ms.

Ex 2) In case of setting data log for a 10ms scan program, the scan time may increase up to 13ms.

Ex 2) In case of setting data log for a 100ms scan program, the scan time may increase up to 130ms.

5.11.2 Save Performance by Scan time

The following figures are save performance measurement by save intervals and number of set data saved. These measurements represent relative values. The actual vales may vary depending on the program, setting parameter and SD memory applied. You can use it as a reference when using data log function.

(1) Set Condition

Data processing time was measured under the following conditions.

Item		Description	Note
Scan Time		1ms / 10ms	
Buffer Size		500kByte	
Data Collection Time		4 Word/ 10ms	
Data Log Setting	Sampling Method	Designated Interval	
	Data	M Area, Type Word	
	CSV Output	Time, Index information included	
	File Save	16MByte	
SD MEMORY CARD		SanDisk 2G	

(2) Results:

Measurement taken under the conditions above showed the following results. The table below does not represent absolute values: in actual use, please consider the scan time and settings.

	Number of Devices					Unit
	4 WORD (4 WORD * 1 Group)	8 WORD (8 WORD * 1 Group)	32 WORD (32 WORD * 1 Group)	64 WORD (32 WORD * 2 Group)	320 WORD (32 WORD * 10 Group)	
1ms	1.5	1.7	1.6	1.7	1.6	ms
10ms	3.5	3.4	3.5	3.2	3.7	

5.11.3 Save Performance of Each Function Setting

(1) Set Condition

Item		Description	Note
Scan Time		1ms	
Function Applied		Data Log, FTP, Web Server	
Buffer Size		500kByte	
Data Log Setting	Sampling Method	Designated Interval	
	Data	M Area, Type Word	
	CSV Output	Time, Index information included	
	File Save	16MByte	
SD MEMORY CARD		SanDisk 2G	

(2) Results:

Measurement taken under the conditions above showed the following results. The table below does not represent absolute values: in actual use, please consider the scan time and settings.

	Number of Devices					Unit
	4 WORD (4 WORD * 1 Group)	8 WORD (8 WORD * 1 Group)	32 WORD (32 WORD * 1 Group)	64 WORD (32 WORD * 2 Group)	320 WORD (32 WORD * 10 Group)	
DL ¹⁾	10	20	40	40	1000	ms
DL + FTP ²⁾	20	40	80	80	2000	
DL + FTP + Web ³⁾	30	60	120	120	3000	

- 1) When using the "Data Log"
- 2) When using the "Data Log + FTP" or "Data Log + Web Server"
- 3) When using the "Data Log + FTP + Web Server"

5.11.4 Impact of Maximum Data Setting on Scan

1) Measurement Condition

Condition	Set Value
Set Group	10
Configuration Data	32 Data
File Save History Setting	Maintains the initial history
SD Memory Storage	4GByte (TLC type)

2) Results

Item Type	Scan Time				Data Collection Interval
	10ms	50ms	100ms	500ms	
BOOL	15ms	65ms	129ms	644ms	1,000ms
BYTE	16ms	65ms	128ms	643ms	1,000ms
WORD	15ms	66ms	128ms	643ms	1,000ms
DWORD	15ms	65ms	128ms	643ms	2,000ms
LWORD	16ms	66ms	129ms	645ms	4,000ms
INT	15ms	65ms	128ms	642ms	1,000ms
DINT	16ms	66ms	129ms	644ms	2,000ms
LINT	17ms	66ms	130ms	645ms	4,000ms
UINT	15ms	65ms	129ms	644ms	1,000ms
UDINT	16ms	67ms	129ms	645ms	2,000ms
ULINT	16ms	66ms	130ms	646ms	4,000ms
USINT	16ms	66ms	129ms	645ms	1,000ms
SINT	16ms	66ms	129ms	643ms	1,000ms
REAL	17ms	69ms	130ms	645ms	2,000ms
LREAL	19ms	69ms	133ms	649ms	4,000ms
STRING	18ms	69ms	132ms	645ms	5,000ms

5.11.5 Save Process Time Verification

Date log function does not guarantee saving of all data under any setting. It performs the maximum operation that PLC is capable of at the time when data log condition occurs. That is, since data log processing time may fluctuate depending on the parameter setting, sampling data amount, scan time and run state of PLC's other functions such as internal communication and position determination, it may not run as specified by the set collection condition in some cases. Therefore, it is recommended to use data log function after verifying each processing time of the system before using data log function.

(1) Save Process Time Verification

The following figure represents the flow from data log function performed by high-performance XGB to saving into SD memory. Details are as follows.

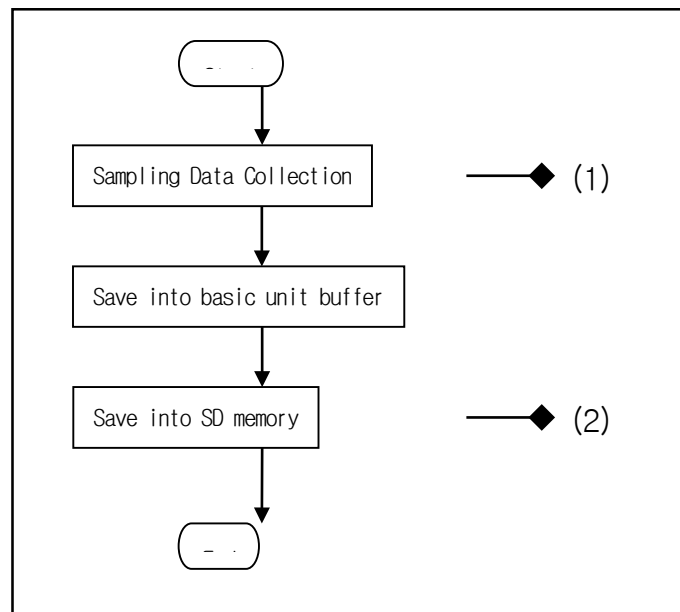

Stage		Operation	Note
(1)	Data Collection	High-performance XGB collects data and saves them into the buffer inside PLC. Although data are collected under the conditions (scan, designated interval) set by the parameter, data may not be collected as per the set conditions depending on data amount, scan time and other factors in some cases. Therefore, it is imperative to verify whether the data are being collected properly.	
(2)	Save Data	Saves the data stored in the buffer into the SD memory in CSV format. When the data save speed is less than the speed of data collection, the internal buffer is exceeded, and data omission may occur. Therefore, it should be verified whether properly collected data can be saved in CSV format.	

(2) Verification of Data Collection Processing Time

This section explains how to verify whether high-performance XGB is collecting the data as per properly set conditions. It should be verified whether all data are being properly collected using Regular Save. Verification methods and solution to possible issues follow.

Verification	Description and Solution		Note
Data Collection Failure Count Flag	Description	Verify whether buffer excess count in Area K is 0. If it is not 0, it means that data omission occurred due to data collection being too fast compared with the data collection time. Insert "C" character strings into the saved file	
	Solution	In case of sampling at designated interval, increase the sampling interval. Decrease the amount of data collected at each sampling. Disable FTP file transmission.	

- (3) If you use a high-performance XGB Data Log function, PLC scan time would be increasing due to the time consumption in collecting and storing data. Setup the parameters refer to measurement result.

Chapter 6. Built-in PID Function

6.1 Features of Built-in PID Function

Here describes built-in PID (Proportional Integral Derivative) function. When there is plant (target of control), Control means that the user changes the status such as velocity, temperature, position, voltage, current etc. as the user wishes. Here describes PID control that is most frequently used among diverse control methods.

Basic concept of PID control is as follows. First, it detects the PV (Process Value) through sensor and calculates what the difference with SV (Set value) is. Then it outputs MV (Manipulated Value) for PV to be same with SV.

At this time, 3 types of operation, such as Proportion, Integration, Derivation is executed according to the requirement of the user. PID control has high compatibility, flexibility, affordability in comparison with Robust control and Linear optimal control. In case of other control methods, since control device can be applied to the system after mathematical analysis of system, if system or the requirement of the user changes, the analysis of system is done again. But in case of PID control, PID device copes with change of system or requirement of the user with simple auto-tunings without analysis of system rapidly.

The figure 6.1 is example indicating system configuration of temperature control of heating system.

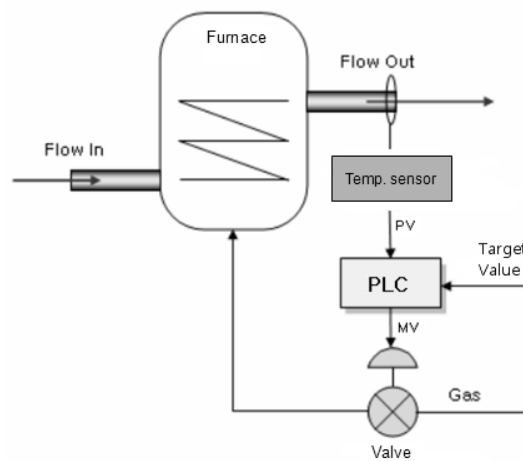

<Figure 6.1PID Temperature control system with PLC>

At this time, PLC becomes control device for this system, output temperature of heating system becomes target for control. And temperature sensor and valve becomes devices to detect and manipulate the status of system respectively. If temperature sensor detects the output temperature and inputs that to PLC, PLC manipulate the valve status through PID operation and control the quantity of gas that goes into heating system. So temperature of heating system changes. This process is called control loop and PID control is executed by repeating the control loop. The control loop is repeated with a cycle of ms ~ s.

The built-in PID control functions of ultimate performance XGB feature as follows.

- (1) Since operations are executed within CPU part, it can be controlled by PID parameters and PLC program without PID module.
- (2) A variety of controls can be selected
 - That is, a user can easily select P operation, PI operation and PID operation.
- (3) Precise control operation
 - It can make precise PID control operations possible through floating point operations.
- (4) PWM (Pulse Width Modulation) output available.
 - It outputs control operation results to the output contact point designated by a user through PWM.
- (5) Improving convenience of control settings and monitoring
 - Through parameter setting method and K area flag, it maximizes control parameter settings during operation and convenience of monitoring
- (6) Freely selectable operation direction
 - Forward, reverse and mixed forward/reverse operations are available
- (7) Cascade operation realizing quick and precise PID control
 - It can increase quickness of response to disturbance through cascade loop.
- (8) Various additional functions
 - PID control can be achieved by various methods a user wishes because set value ramp, the present value follow-up, limiting change of values and types of alarm functions are provided.

6.2 Basic Theory of PID Control

Here describes basic theory of PID control and how to configure PID control.

(1) Terms

Terms used in this user manual are as follows.

- PV: status of plant detected by sensor (Process value)
- SV: Target value (Set Value) to control plant, if control is done normally, PV should follow the SV.
- E: error between SV and PV. It can be expressed as (SV-PV).
- K_p: proportional coefficient
- T_i: Integral time constant. Sometimes called integral time
- T_d: Derivative time constant. Sometimes called derivative time
- MV: Control input or control device output. The input to plant to make PV follow the V
- T_s: Sampling time, a cycle of operation to execute PID control

(2) PID operation expression

Basic PID operation expressions are as follows.

$$E = SV - PV \quad (6.2.1)$$

$$MV_p = K_p E \quad (6.2.2)$$

$$MV_i = \frac{K_p}{T_i} \int E dt \quad (6.2.3)$$

$$MV_d = K_p T_d \frac{dE}{dt} \quad (6.2.4)$$

$$MV = MV_p + MV_i + MV_d \quad (6.2.5)$$

PID control operation expressions of XGB series are more complicate than expression (6.2.1) ~ (6.2.5) mathematically but those are based on the above expression. The followings describe the characteristics of control process with an example that controls the output temperature of heating system in figure 6.1. At this example, the system and PID parameters imaginary to help the comprehension and those may be different with real heating system. If the heating system in figure 6.1 is expressed as second order system with transfer function like expression (6.2.6) in frequency domain, it is expressed as differential equation like expression (6.2.6) in the time domain.

$$\text{Transfer function} = \frac{32}{(2s+1)(3s+5)} \quad (6.2.6)$$

$$\frac{6}{32} \frac{d^2 y(t)}{dt^2} + \frac{13}{32} \frac{dy(t)}{dt} + 5y(t) = x(t) \quad (6.2.7)$$

That is, $x(t)$ is Manipulated value and $y(t)$ is Process value.

At this system, we assume that the PID parameter is specified as shown below to describe the PID control operation.

Items	Value	Items	Value
Output temperature of heating system (PV)	0°C	Proportional coefficient (K_P)	5
Target temperature (SV)	50°C	Integral time (T_i)	3s
Cycle of operation	0.01s	Derivative time (T_d)	0.19s

<Table 6.1 example of control of heating system>

At this system, if we assume that target value of output temperature is 50°C and initial value of output temperature is 0°C, SV and PV becomes 50 and 0 respectively. In case of this, PID controller acts as follows.

(3) Proportional control (P control)

In the proportional control, the controller yields output that is proportional to error.

Manipulated value of controller by Proportional control is as follows.

$$MV_P = E \times K_P \quad (6.2.8)$$

(a) If P control starts, output of controller by initial P operation is as follows.

$$MV_0 = 50 \times 4 = 200$$

If P control is executed for 10 seconds, output temperature will be as table 6.2.

If this is expressed with graph, it will be as Figure 6.2.

Time	Target temp.	Proportional coefficient	Output temp.	Error
0	50	5	0	50
1	50	5	44.98	5.02
2	50	5	53.08	-3.08
3	50	5	50.15	-0.15
4	50	5	48.42	1.58
5	50	5	48.28	1.72
6	50	5	48.44	1.56
7	50	5	48.49	1.51
8	50	5	48.49	1.51
9	50	5	48.49	1.51

< Table 6.2 example of Proportional control >

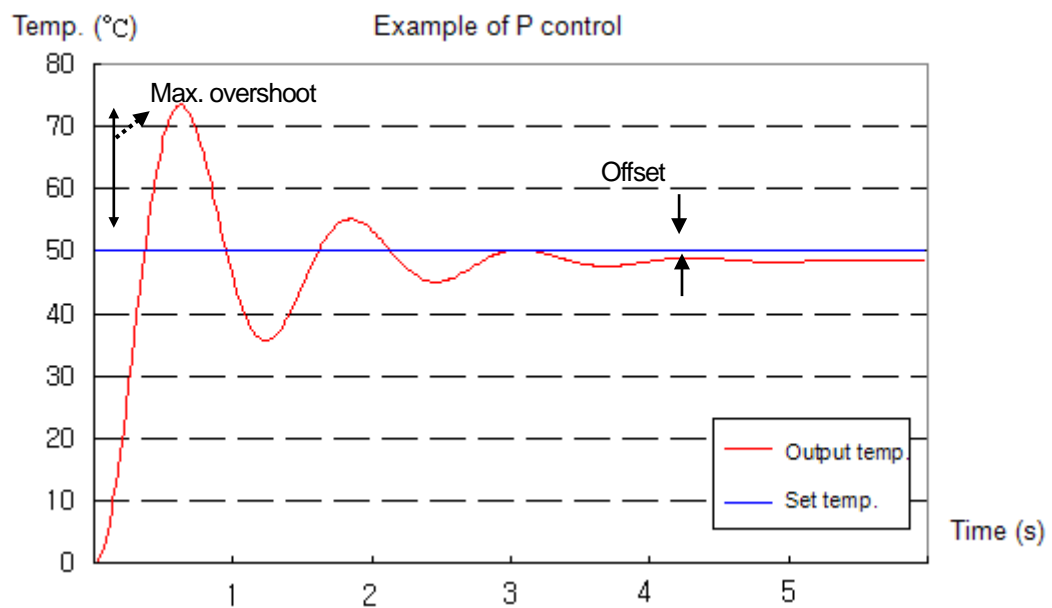

< Figure 6.2 simulation of proportional control >

(b) Concerning the result of simulation, it has the maximum overshoot of about 23.4°C at 0.62s and after 7s, it converges at 48.49°C with offset of 1.51°C (about 3%).

(c) Offset is an unavoidable error when only P control is executed. Offset decreases proportional to P coefficient but overshoot increases proportional to P coefficient. Table 6.3 and Figure 6.3 is simulation of offset and overshoot according to P coefficient.

Time	Target temperature	Kp = 5	Kp = 2.5	Kp = 1
0	50	0	0	0
1	50	45.02	63.46	46.67
2	50	53.11	42.52	46.77
3	50	50.15	47.93	41.38
4	50	50.22	47.25	41.60
5	50	48.27	46.96	43.30
6	50	48.35	46.92	43.25
7	50	48.44	46.90	43.21
8	50	48.53	46.90	43.18
9	50	48.53	46.90	43.18

<Table 6.3 Temperature- time table according to P coefficient>

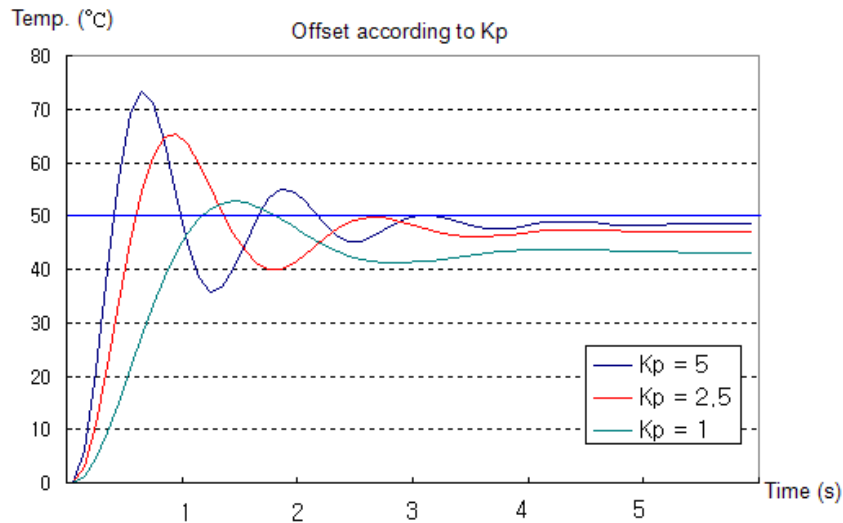

< Figure 6.3 Temperature- time graph according to P coefficient >

(c) Considering table 6.3, as P coefficient decreases, offset increases but overshoot decreases.

(d) Generally, offset can't be solved with only P control. In order to remove the offset, P control and I control is used together.

(4) Proportional Integral Control (PI Control)

In I control, it yields the output proportional to error accumulated according to time. And the expression is as follows.

$$MV_i = \frac{K_P}{T_i} \int Edt \quad (6.2.9)$$

(a) In the expression 6.2.9, T_i means the time takes for MV_i , output by I control, to be added into real output.

(b) Generally, I control is used with P control. So the expression of PI control is as follows.

$$MV = MV_P + MV_i = E \times K_P + \frac{K_P}{T_i} \int Edt \quad (6.2.10)$$

(c) In the above heating system, the simulation results are as shown in the table 6.4 when proportional coefficient is 2.5 and integral time is 1.5s.

Time	Target temp.	Proportional coefficient	Integral time	P Control	PI Control
0	50	2.5	1.5	0	0
1	50	2.5	1.5	63.46	74.41
2	50	2.5	1.5	42.52	40.63
3	50	2.5	1.5	47.93	52.99
4	50	2.5	1.5	47.05	49.67
5	50	2.5	1.5	46.96	49.70
6	50	2.5	1.5	47.12	50.38
7	50	2.5	1.5	47.03	49.76
8	50	2.5	1.5	47.07	50.14
9	50	2.5	1.5	47.06	49.94
10	50	2.5	1.5	47.06	50.02
11	50	2.5	1.5	47.06	49.99
12	50	2.5	1.5	47.06	50.00
13	50	2.5	1.5	47.06	50.00
14	50	2.5	1.5	47.06	50.00
15	50	2.5	1.5	47.06	50.00

< Table 6.4 Temperature- time table according to P coefficient >

(d) Considering table 6.4 and Figure 6.4, if P and I control is used together, offset is removed and temp. converges at 50°C, target temp. after 12s

(e) But in this case, convergence time is longer than that of P control and overshoot is larger. Generally, as integral time increases, overshoot decrease. About this, refer to the Figure 6.5.

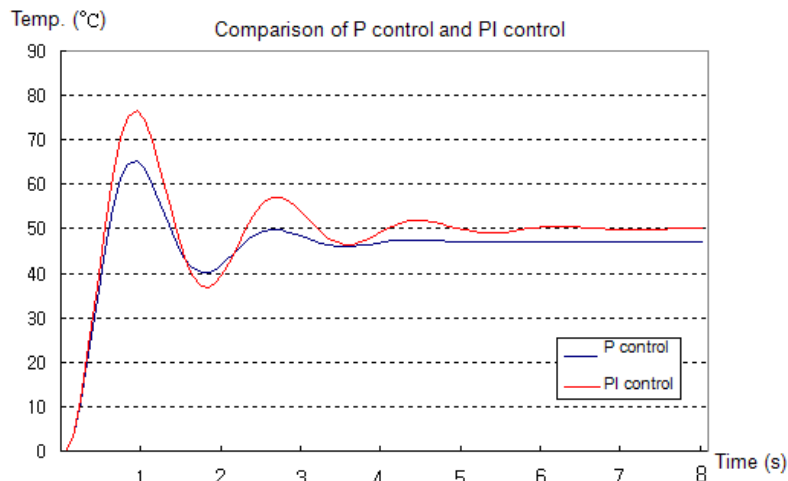

< Figure 6.4 Temp.- time graph >

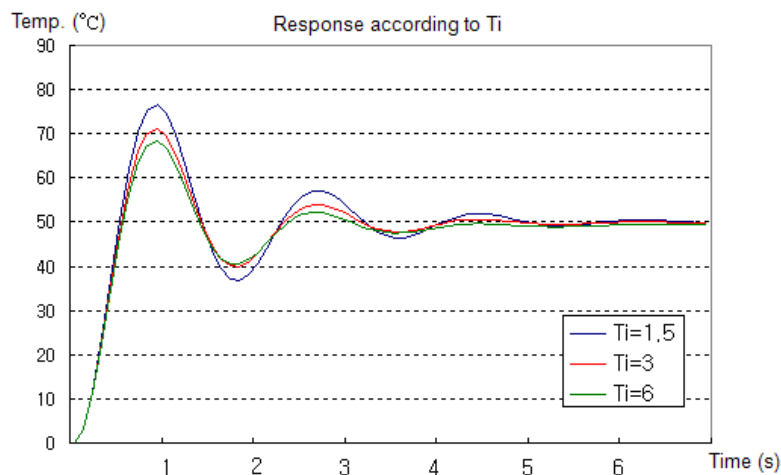

< Figure 6.5 overshoot according to integral time >

(f) Like this, if I control is used, overshoot is larger. According to system, large overshoot can be problem. In order to solve this, PID control is used.

(5) Proportional integral derivative control (PID control)

In D control, when status of system changes rapidly, D control yields the output to reduce the error. Namely, D control yields the output proportional to change velocity of current status. So if D control is used, response speed of controller about status change of system increases, and overshoot decreases. Output of controller by D control is as shown in expression 6.2.11.

$$MV_d = K_P T_d \frac{dE}{dt} \quad (6.2.11)$$

(a) In the expression 6.2.11, T_d means the time takes for MV_d output by I control, to be added into real output.

(b) Generally, D control is not used solely but with PD control. So PID control is expressed as expression 6.2.12.

$$MV = MV_p + MV_i + MV_d = E \times K_p + \frac{K_p}{T_i} \int E dt + K_p T_d \frac{dE}{dt} \quad (6.2.12)$$

(c) The Figure 6.6 is simulation result when PID control is applied to above heating system.

Time	Target temp.	Proportional coefficient	Integral time	Derivative time	PI Control	PID Control
0	50	2.5	1.5	0.3	0	0
1	50	2.5	1.5	0.3	74.41	55.50
2	50	2.5	1.5	0.3	40.63	56.33
3	50	2.5	1.5	0.3	52.99	52.50
4	50	2.5	1.5	0.3	49.67	50.92
5	50	2.5	1.5	0.3	49.70	50.34
6	50	2.5	1.5	0.3	50.38	50.12
7	50	2.5	1.5	0.3	49.76	50.05
8	50	2.5	1.5	0.3	50.14	50.02
9	50	2.5	1.5	0.3	49.94	50.01
10	50	2.5	1.5	0.3	50.02	50.00
11	50	2.5	1.5	0.3	49.99	50.00
12	50	2.5	1.5	0.3	50.00	50.00
13	50	2.5	1.5	0.3	50.00	50.00

< Table 6.5 comparison of PI control and PID control >

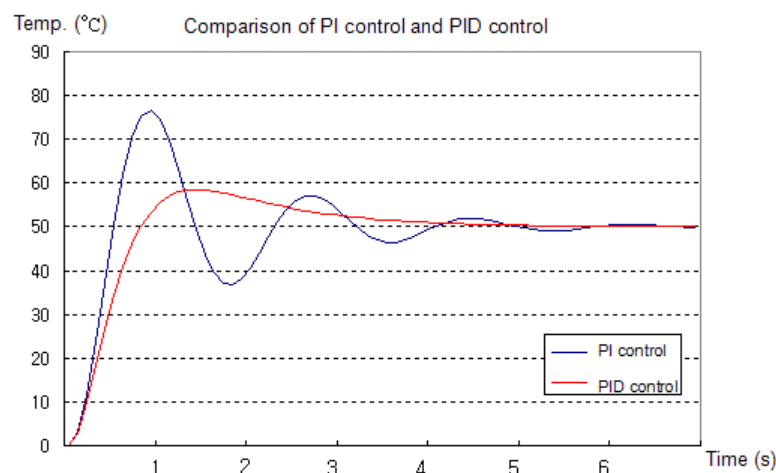

< Figure 6.6 comparison of PI control and PID control >

(d) Considering table 6.5, in case PID control is used, max. overshoot decreases from 16.5°C to 8.5°C. At this time, P coefficient, integral time, derivative time are not optimal values, just one of the examples. Actually, P coefficient, integral time, derivative time values vary according to PID control system.

6.3 Functional Specifications of PID Control

The performance specifications of the built-in PID control function in XGB series are summarized in the below table.

Item		Specifications
No. of loops		16 Loop
Scope of setting PID constants	Proportional constant(P)	Real number (0 ~ 3.40282347e+38)
	Integral constant(I)	Real number (0 ~ 3.40282347e+38), unit: second
	Differential constant(D)	Real number (0 ~ 3.40282347e+38), unit: second
Scope of set value		INT (-32,768 ~ 32,767)
Scope of present value		INT (-32,768 ~ 32,767)
Scope of maneuver value		INT (-32,768 ~ 32,767)
Scope of manual maneuver value		INT (-32,768 ~ 32,767)
Indication	RUN/STOP	Operation: PID RUN Flag On (by loops) Stop: PID RUN Flag Off (by loops)
	Error	Normal: PID Error Flag Off (by loops) Error: PID Error Flag On, Error code occurrence (by loops)
	Warning	Normal: PID Warning Flag Off (by loops) Error: PID Warning Flag On, Warnig code occurrence (by loops)
Control operation		Control of P,PI,PD and PID, control of forward/reverse operation
Control interval		10.0ms ~ 6,553.6ms (0.1msUnit)
Additional functions	PWM output	Supportable
	Mixed forward/reverse output	Supportable
	Limiting change of present value	INT (-32,768 ~ 32,767)
	Limiting change of maneuver value	INT (-32,768 ~ 32,767)
	Equally dividing set value	0 ~ 65,536 (frequency of control cycle time)
	Present value follow-up	0 ~ 65,536 (frequency of control cycle time)
	Cascade control	Supportable.
	Min./max. present value	-32,768 ~ 32,767
	Differential filter	0.01 ~ 655.35 (x 100 Scaled Up)
	Dead band setting	0 ~ 65,535
	Prevention of dual integral accumulation	Supportable
PID operation pause	Supportable	

< Table 6.6 built-in PID control performance specification >

6.4 Usage of PID Control Functions

6.4.1 PID Control Parameter Setting

To use the built-in PID control function of XGB series, it is necessary to set PID control parameters by loops in the parameter window and operate it through the commands. Here, it explains parameters to use PID control functions and how to set them.

(1) PID parameter settings

Follow the steps below to set the PID control function parameters of XGB series.

- (a) If selecting the built-in parameters in Parameter of the project window, it shows the built-in parameter setting window as in below figure.

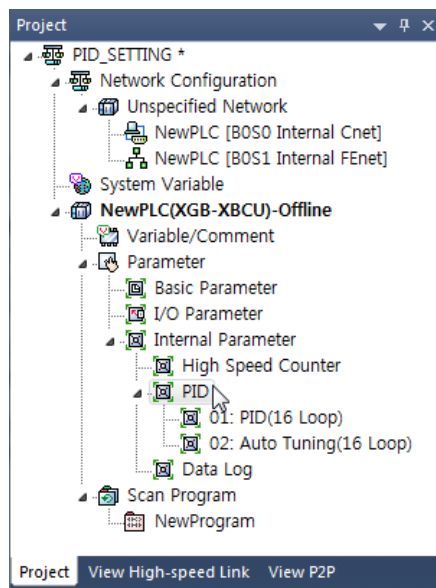

< Figure 6.7 Parameters setting window >

- (b) If selecting PID Control, it shows the PID control parameter setting window as in below figure.

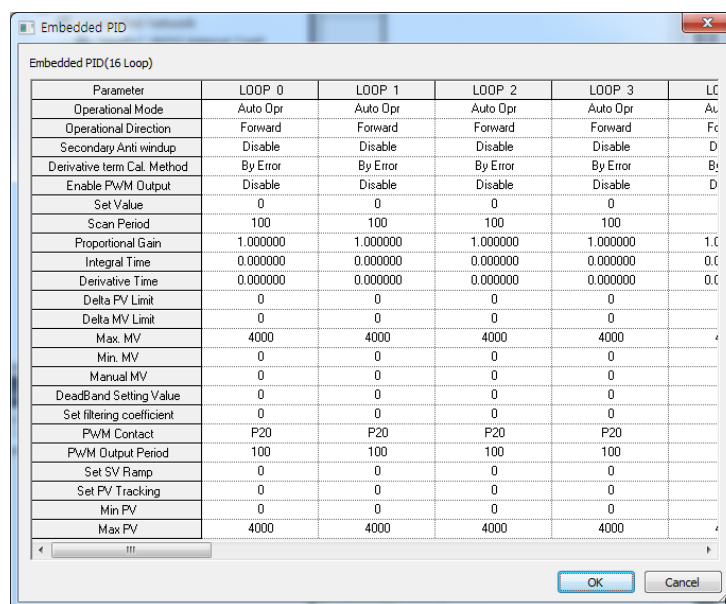

[Figure 6.8 Built-in PID function parameters setting window]

(c) Input items

The items to set in the built-in PID function parameter window and the available scope of them are summarized in below table.

Items	Description	Scope
RUN mode	Set the operation mode of PID control.	Auto/manual operation
RUN direction	Set the operation direction of PID control.	Forward/reverse
Prevention of dual integral accumulation	Set whether to allow dual integral accumulation.	Disabled/enabled
Differential Control Calculation Method	Select the PID derivative operation source.	PV/ERR
PWM output	Set whether to allow PWM output of maneuver value.	Disabled/enabled
Operation cycle time	Set the operation cycle time of PID control cycle.	100 ~ 65535
Set value	Set target control value.	-32,768 ~ 32,767
Proportional gain	Set proportional gain.	Real number
Integral time	Set integral time.	Real number
Differential time	Set differential time.	Real number
Limiting change of present value	Set the limited change of present value per operation cycle.	-32,768 ~ 32,767
Limiting change of maneuver value	Set the limited change of maneuver value per operation cycle.	-32,768 ~ 32,767
Max. maneuver value	Set the max. maneuver value for control.	-32,768 ~ 32,767
Min. maneuver value	Set the min. maneuver value for control.	-32,768 ~ 32,767
Manual maneuver value	Set the manual maneuver value for control.	-32,768 ~ 32,767
DeadBand setting	Set the deadband width of the set value.	0 ~ 65,535
Differential filter value	Set the filter coefficient of differential operation.	0 ~ 65,535
PWM junction	Set the junction to which PWM output is out.	P20 ~ P3F
PWM output cycle	Set the output cycle of PWM output.	100 ~ 65,535
Set value ramp	Set the frequency of set value ramp.	0 ~ 65,535
Present value follow-up	Set the follow-up frequency of the present value follow-up function.	0 ~ 65,535
Min. present value	Set the min. value of the input present value.	-32,768 ~ 32,767
Max. present value	Set the max. value of input present value.	-32,768 ~ 32,767

< Table 6.7 PID function parameter setting items >

(2) Description of Setting of PID Parameters

(a) Operation mode

It is the mode to set the operation for PID control of a loop in question.

The available scope is automatic operation or manual operation.

If automatic operation is selected, it outputs the PID control result internally operated by the input PID control parameter as the maneuver value while if manual operation is selected, it outputs the value input to the manual maneuver value parameter without PID operation modified. The default is automatic operation.

(b) Operation direction

It is designed to set the operation direction for PID control of a loop in question. The available scope is forward or reverse direction. At the moment, forward direction means increase of PV when MV increases; reverse direction means decrease PV when MV increases. For instance, a heater is a kind of forward direction system because PV(temperature) increases when

output(heating) increases. A refrigerator is a kind of reverse direction system in which PV(temperature) decreases when output increases.

(c) Prevention of dual integral accumulation

It makes dual integral accumulation function enabled/disabled. To understand integral accumulation prevention function, it is necessary to explain the phenomenon of integral accumulation first of all. Every drive has a limit. That is, a motor is limited to the speed and a valve can become status overcoming the complete open/close. If it happens that MV output from a control is beyond the output limit of a drive, its output is maintained as saturated, which may deteriorate the control performance of a system and shorten the life of a drive. Formula (6.2.3) shows that the integral control among PID control output components accumulates errors as time goes on, from which it may take more time to return the normal status after the actuator is saturated in a system of which response characteristically is slow. It is so called integral accumulation phenomenon as illustrated in Fig. 6.9, which shows that if the initial error is very large, the error is continuously accumulated by integral control. Accordingly, a drive is saturated within its output upper limit while the control signal is getting larger, keeping being saturated for a long while until the drift becomes negative and the integral term turns small enough. Due to the operation, the PV may have a large over-shoot as seen in the figure. Such a wind-up phenomenon may occur if the initial drift is large or by a large disturbance or due to malfunction of a device.

The PID function of XGB series is basically with the integral accumulation prevention function, cutting off any integral accumulation phenomenon. In addition, it can detect a time when SV is suddenly decreased, providing a more strong dual integral accumulation prevention function.

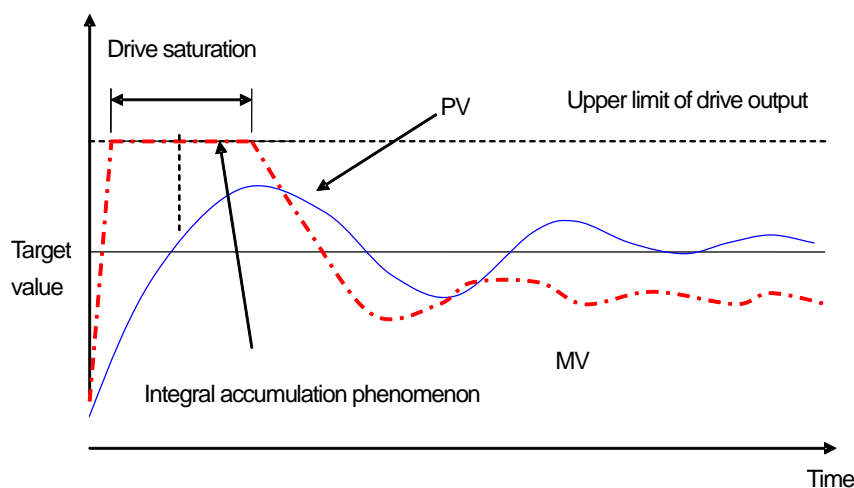

< Figure 6.9 Integral accumulation phenomenon >

(d) PWM Output Enabled

PWM output means an output method to turn a junction on – off with a duty proportional to control output calculated by a uniform output cycle. If PWM output is enabled, it realizes PWM output in accordance with PWM output cycle set in the parameter of PWM output junction(P20 ~ P3F) designated in the parameter. At the moment, the PWM output cycle follows the PWM output cycle separately set in PID operation cycle. PWM output cycle is available between 10ms ~ 6553.5ms (setting value: 100 ~ 65,535) while it is set at a unit of integer per 0.1ms.

(Be aware, actual PWM output value have max 2ms output err)

figure shows the relation between PID control output and PWM output.

Ex) if PWM output cycle: 1 second, PWM output junction: P20, max. output: 10000, min. output: 0

Time	Output	P40 junction operation
0 sec	5000	0.5 sec On, 0.5 sec Off
1 sec	3000	0.3 sec On, 0.7 sec Off

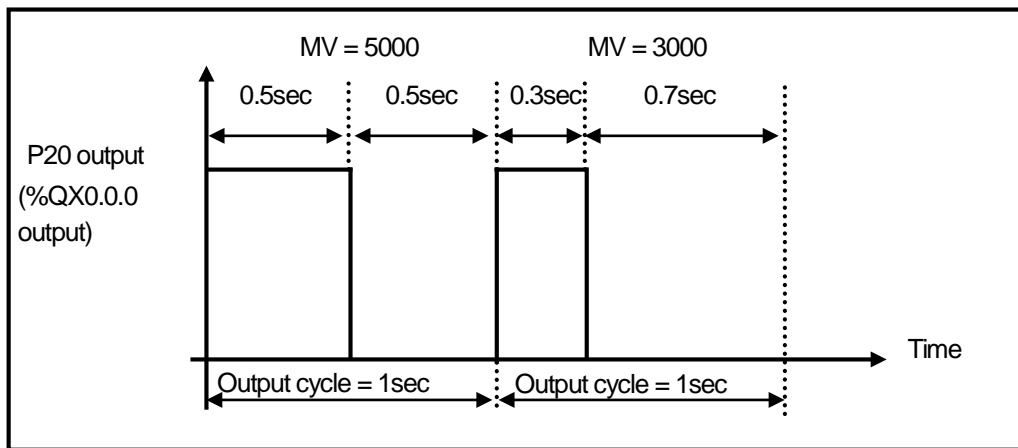

[Figure 6.10 Relation between PWM output cycle and MV]

(e) Set value

It sets the target of a loop in question, that is, the target status a user wishes to control. In case of the PID control built in XGB, physical values (temperature, flow rate, pressure and etc) of an object to control is not meaningful and instead, it should use the physical amount of an object to control after converting them into numerals. For instance, in order to control a system using a sensor that the output is 0V when its heating device temperature is 0°C while it is 10V when the temperature is 100°C as much as 50°C, it is necessary to set SV as 2000 (as long as it uses AD input module XBE-AD04A).

(f) Operation cycle

It sets the cycle to yield control output by executing the built-in PID operation. The setting cycle is 0.1ms and available between 10ms ~ 6553.5ms (setting value: 100 ~ 65,535) while it is set at a unit of integer per 0.1ms. For instance, to set PID operation per 100ms, set the operation cycle as 1000.

(g) Proportional gain

It is intended to set the proportional coefficient of a PID loop in question (K_p). As larger K_p , the proportional control operation is getting stronger. The scope is real number.

(h) Integral time

It sets the integral time of PID loop in question (T_i). As larger the integral time, the integral operation is getting weaker. The scope is real number at the unit of second.

(i) Differential time

It sets the differential time of PID loop in question (T_d). As larger the differential time, the differential operation is getting stronger. The scope is real number at the unit of second.

(j) Limiting change of present value

It sets the limit of change in present value of PID loop in question. If PV suddenly changes due to signal components such as sensor's malfunction, noise or disturbance during control of PID, it may cause sudden change of PID control output. To prevent the phenomenon, a user can set the max. limit of change in present value that is allowed per PID operation cycle. If the change of present value is limited accordingly, it may calculate the present value as much as the limit although the present value is changed more than the limit once the limit of change in present value is set. If using the PV change limit function, it may prevent against sudden change of control output owing to noise or etc. If it is, however, set too small, it may reduce the response speed to the PV change of an actual system, not to sudden change by noise or etc, so it is necessary to set the value appropriately according to the environment of a system to control in order that the PV toward the set value does not take a longer time. The available scope is between -32,768~32,767. If setting the PV change limit as 0, the function is not available.

(k) Limiting change of MV (Δ MV function)

It limits the max. size that control output, which is output by PID operation is changed at a time. The output MV in this operation cycle is not changed more than the max. change limit set in the previous operation cycle. The function has an effect to prevent a drive from operating excessively due to sudden change of output by preventing sudden change of output resulting from instantaneous change of set value. If it is, however, set too small, it may cause taking a longer time until PV reaches to its target, so it is necessary to adjust it appropriately. The available scope is between -32,768 ~ 32,767. If setting it as 0, the function does not work.

(l) Max. MV

It sets the max. value of control output that may be output by the result of PID operation. The available scope is between -32,768 ~ 32,767. If it exceeds the max. output designated by PID operation result, it outputs the set max. output and alerts the max. output excess warning. For the types and description of warnings, refer to Error/Warning Codes.

(m) Min. MV

It sets the min. value of control output that may be output by the result of PID operation. The available scope is between -32,768 ~ 32,767. If it is smaller than the min. output value designated by PID operation result, it outputs the set min. MV and alerts the min. output shortage warning. For the types and description of warnings, refer to Error/Warning Codes.

(n) Manual MV

It sets the output when the operation mode is manual. The available scope is between -32,768 ~ 32,767.

(o) DeadBand setting

It sets the deadband between set value and present value. Although it may be important to reduce normal status reply of PV for its set value even when MV fluctuates heavily, depending on control system, it may be more important to reduce the frequent change of MV although the normal status reply is somewhat getting larger. DeadBand may be useful in the case. Below figure shows an example of DeadBand setting.

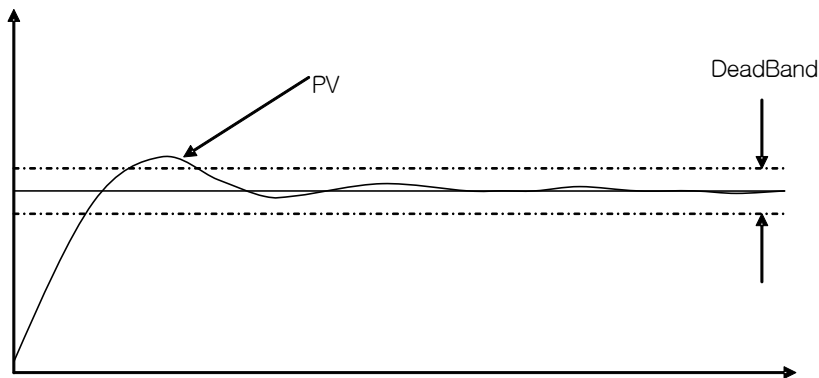

[Figure 6.11 Example of DeadBand setting]

If setting deadband as in the figure, the PID control built in XGB may regard the error between PV and set value as 0 as long as PV is within the available scope of deadband from set value.

That is, in this case, the change of MV is reduced. The available scope of setting is between 0 ~ 65,535 and if it is set as 0, it does not work.

(o) Differential Filter Value Setting

It sets the coefficient of differential filter. Since differential control outputs in proportion to gradient of error and gradient of PV change, it may suddenly change MV as it generates a large response to instantaneous noise or disturbance. To prevent it, XGB series uses a value to which PV is filtered mathematically for differential control. Differential filter value is the coefficient to determine the filter degree for differential control. As smaller differential value set, as stronger differential operation is. The available scope is between 0 ~ 65,535 and if it is set as 0, the differential filter does not work.

(p) Setting set value ramp

Since the drift is suddenly large if SV is heavily changed during PID control, MV is also changed heavily to correct it. Such an operation may cause excessive operation of a system to control and a drive. To prevent it, SV ramp is used, changing SV gradually step by step when modifying SV during operation. If using the function, SV is gradually changed by SV ramp when SV is changed during PID control. At the moment, SV ramp setting represents the frequency of PID operation cycle taken from when SV starts changing to when it reaches to the final SV. For instance, if SV is to be changed from 1000 to 2000 during operation as PID operation cycle is 10ms and its SV ramp is 500, SV may reach to 2000 after $500 \times 10\text{ms} = 5$ seconds, that is, as it increases each 2 per operation cycle and after the 500th operation scans. The available scope of setting is between 0 ~ 65,535 and it is set as 0, it does not work.

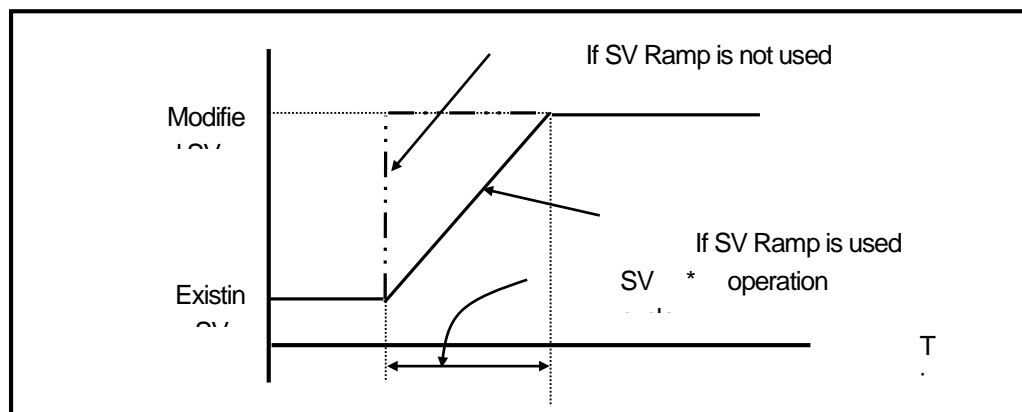

[Figure 6.12 SV Ramp function]

(q) PV Follow-up setting

It is intended to prevent any excessive operation of a drive resulting from sudden change of output at the initial control and changes SV gradually from PV at the time when PID operation starts, not directly to SV in case control just turns from stop to operation mode or it changes from manual to automatic operation. At the moment, SV represents the frequency of PID operation cycles taken from when control starts to when it reaches to the set SV (other operations are same as SV ramp function). The available scope is between 0 ~ 65,535. If SV is changed again while PV follow-up is in operation, the SV would be also changed according to SV ramp.

(r) Min./max. PV

It sets the min./max. value entered as the present value of PID control. The available scope is between -32,768 ~ 32,767.

6.4.2 PID Flags

The parameter set by the XGB series built-in PID control function is saved into the flash memory of the basic unit. Such parameters are moved to K area for the built-in PID function as soon as PLC turns from STOP to RUN mode. PID control operation by PID control command is executed through K area data for PID functions. Therefore, if a user changes the value in the trend monitor window or variable monitor window during operation, PID operation is executed by the changed value. At the moment, if PLC is changed to RUN again after being changed to STOP, it loads the parameters in flash memory to K area, so the data changed in K area is lost. Thus, to keep applying the parameters adjusted in K area, it is necessary to write the parameter set in K area to flash memory by using WRT command. (In case of IEC, APM_WRT)

(1) PID Flag Configuration

K area flags for XGB series built-in PID control function are summarized in the below table.

Loop	K area	IEC type	Symbol	Data type	Default	Description
Common	K12000~F	%KX19200~15	_PID_MAN	Bit	Auto	PID output designation (0:auto, 1>manual)
	K12010~F	%KX19216~31	_PID_PAUSE	Bit	RUN	PID pause (0:RUN, 1:pause)
	K12020~F	%KX19232~47	_PID_REV	Bit	Forward	Control direction(0:forward, 1:reverse) operation control
	K12030~F	%KX19248~63	_PID_AW2D	Bit	Disabled	Dual integral accumulation Prevention (0:enabled, 1:disabled)
	K12040~F	%KX19264~79	_PID_REM_RUN	Bit	Disabled	PID remote operation (0:disabled, 1:enabled)
	K1205~K1207	%KW1205~%KW1207	Reserved	WORD	-	Reserved area
	K12080~F	%KX19328~43	_PID_PWM_EN	Bit	Disabled	PWM output enable (0:disabled, 1:enabled)
	K12090~F	%KX19344~59	_PID_STD	Bit	-	PID operation indication (0:stop, 1:run)
	K12100~F	%KX19360~75	_PID_ALARM	Bit	-	PID warning (0:normal, 1:warning)
	K12110~F	%KX19376~91	_PID_ERROR	Bit	-	PID error(0:normal, 1:error)
	K12120~F	%KX19392~407	_PID_MV_BMPL	Bit	Disabled	PID MV BuMPLess changeover (0:disabled, 1:enabled)
K1213~K1215	%KW1213~%KW1215	Reserved	WORD	-	Reserved	
Loop 0	K1216	%KW1216	_PID00_SV	INT	0	PID SV
	K1217	%KW1217	_PID00_T_s	WORD	100	PID operation cycle[0.1ms]
	K1218	%KD609	_PID00_K_p	REAL	1	PID proportional constant
	K1220	%KD610	_PID00_T_i	REAL	0	PID integral time[sec]
	K1222	%KD611	_PID00_T_d	REAL	0	PID differential time[sec]
	K1224	%KW1224	_PID00_d_PV_max	WORD	0	PID PV change limit
	K1225	%KW1225	_PID00_d_MV_max	WORD	0	PID MV change limit
	K1226	%KW1226	_PID00_MV_max	INT	4000	PID MV max. value limit
	K1227	%KW1227	_PID00_MV_min	INT	0	PID MV min. value limit
	K1228	%KW1228	_PID00_MV_man	INT	0	PID manual output
	K1229	%KW1229	_PID00_PV	INT	-	PID PV

< Table 6.8 K area flags for PID control >

Loop	K area	IEC type	Symbol	Data type	Default	Description
Loop 0	K1230	%KW1230	_PID00_PV_old	INT	-	PID PV of previous cycle
	K1231	%KW1231	_PID00_MV	INT	0	PID MV
	K1232	%KD616	_PID00_ERR	DINT	-	PID control error
	K1234	%KD617	_PID00_MV_p	REAL	0	PID MV proportional value component
	K1236	%KD618	_PID00_Mv_i	REAL	0	PID MV integral control component
	K1238	%KD619	_PID00_MV_d	REAL	0	PID MV differential control component
	K1240	%KW1240	_PID00_DB_W	WORD	0	PID deadband setting
	K1241	%KW1241	_PID00_Td_lag	WORD	0	PID differential filter coefficient
	K1242	%KW1242	_PID00_PWM	WORD	H'20	PID PWM junction setting
	K1243	%KW1243	_PID00_PWM_Prd	WORD	100	PID PWM output cycle
	K1244	%KW1244	_PID00_SV_RAMP	WORD	0	PID SV Ramp value
	K1245	%KW1245	_PID00_PV_Track	WORD	0	PID PV follow-up setting
	K1246	%KW1246	_PID00_PV_MIN	INT	0	PID PV min. value limit
	K1247	%KW1247	_PID00_PV_MAX	INT	4000	PID PV max. value limit
	K1248	%KW1248	_PID00_ALM_CODE	Word	0	PID warning code
	K1249	%KW1249	_PID00_ERR_CODE	Word	0	PID error code
	K1250	%KW1250	_PID00_CUR_SV	INT	0	PID SV of current cycle
		K1251-1255	%KW1251-1255	Reserved	WORD	-
Loop 1	K1256~K1295	%KW1256~%KW1295	-	-	-	PID Loop1 control parameter
~						
Loop16	K1816~K1855	%KW1816~%KW1855	-	-	-	PID Loop16 control parameter

< Table 6.8 K area flags for PID control (continued) >

K1200 ~ K1211 areas are the common bit areas of PID loops while each bit represents the status of each PID control loop. Therefore, each 16 bits, the max number of loops of XGB PID control represents loop status and setting respectively. K1216 ~ K1255 areas are K areas for PID control loop 0 and save the loop 0 setting and status. It also contains parameters such as SV, operation cycle, proportional coefficient, integral time and differential time set in the built-in parameter window and the XGB built-in PID function executes PID control by each device value in question. In addition, the output data such as MV calculated and output while PID control is executed is also saved into the K areas. By changing the values in K areas, control setting may be changed any time during PID control.

Remark

By changing value of area, you can change control setting whenever you want during the PID control

1) PID control flag expression : _PID[n]_xxx

→ [n] : loop number

→ xxx : flag function

Ex) _PID10_K_p : means K_p of loop 10.

(2) PID flag function

Each function of K area flags for XGB series built-in PID control function is summarized as follows.

(a) Common bit area

The area is a flag collecting operation setting and information consisting of bits to each 16 loop. Each bit of each word device represents the information of each loop. That is, 'n' th bit represents the information about PID loop n.

1) _PID_MAN (PID RUN mode setting)

Flag name	address	IEC type address	Unit	Setting
_PID_MAN (PID RUN mode setting)	K1200n	%KX19200 + n	BIT	Available

It determines whether to operate the PID control of n loop automatically or manually. For more information about RUN mode, refer to 6.2.3 PID control parameter setting. If the bit is off, it operates automatically; if on, it runs manually.

2) _PID_PAUSE (PID Pause setting)

Flag name	Address	IEC type address	Unit	Setting
_PID_PAUSE (PID pause setting)	K1201n	%KX19216 + n	BIT	Available

It changes PID control of n loop to pause status. If PID control is paused, the control MV is fixed as the output at the time of pause. At the moment, PID operation is continued internally with output fixed. If changing pause status to operation status again, it resumes control, so it may take a longer time until the PV is going to SV once system status is largely changed during pause. If the bit is off, it cancels pause; if on, it operates as paused.

3) _PID_REV (PID RUN direction setting)

Flag name	Address	IEC type address	Unit	Setting
_PID_REV (PID RUN direction setting)	K1202n	%KX19232 + n	BIT	Available

It sets the RUN direction of PID control of 'n'th loop. For more information about run direction, refer to 7.2.3 PID control parameter setting. If the bit is off, it operates normally; if on, it operates reversely.

4) _PID_AW2D (Dual Integral accumulation prevention setting)

Flag name	Address	IEC type address	Unit	Setting
_PID_AW2D (dual integral accumulation prevention setting)	K1203n	%KX19248 + n	BIT	Available

It sets enable/disable of dual integral accumulation prevention of 'n'th loop. For more information about dual integral accumulation prevention, refer to 7.2.3 PID control parameter setting. If the bit is off, it is enabled; if on, it is disabled.

5) `_PID_D_on_ERR` (Select differential calculation source)

Flag name	Address	IEC type address	Unit	Setting
<code>_PID_D_on_ERR</code> (Select differential calculation source)	K1206n	%KX19296 + n	BIT	Available

Set the D operation source of the nth loop to PV / ERR.

6) `_PID_REM_RUN` (PID remote operation setting)

Flag name	Address	IEC type address	Unit	Setting
<code>_PID_REM_RUN</code> (PID remote run setting)	K1204n	%KX19264 + n	BIT	Available

XGB series built-in PID function can be started by both run from command's start junction and remote run bit setting. That is, XGB starts PID control if PIDRUN command's start junction is on or remote run setting bit is on. Namely, if one of them is on, it executed PID control.

7) `_PID_PWM_EN` (PWM output enable)

Flag name	Address	IEC type address	Unit	Setting
<code>_PID_PWM_EN</code> (PWM output enable)	K1208n	%KX19328 + n	BIT	Available

It determines whether to output the MV of PID control of 'n'th loop as PWM output. For more information about PWM output, refer to 6.2.3 PID control parameter setting. If the bit is off, it is disabled; if on, it is enabled.

8) `_PID_STD` (PID RUN status indication)

Flag name	Address	IEC type address	Unit	Setting
<code>_PID_STD</code> (PID RUN status indication)	K1209n	%KX19344 + n	BIT	Unavailable

It indicates the PID control RUN status of 'n' th loop. If a loop is running or paused, it is on while if it stops or has an error during RUN, it is off. In the area as monitoring area, it is changed to the current run status by PLC although a user enters any value temporarily.

9) `_PID_ALARM` (PID Warning occurrence)

Flag name	Address	IEC type address	Unit	Setting
<code>_PID_ALARM</code> (PID Warning occurrence)	K1210n	%KX19360 + n	BIT	Unavailable

It indicates warning if any warning occurs during PID control of 'n'th loop. Once a warning occurs during PID control operation of a loop, it is on while if it is normal, it is off. At the moment, despite of warning, PID control continues without interruption, but it is desirable to check warning information and take a proper measure. Once a warning occurs, the warning code is also indicated in warning code area of a loop. For more information about the types of warning codes and measures, refer to 6.5. In the area as monitoring area, it is changed to the current run status by PLC although a user enters any value temporarily.

10) _PID_ERROR (PID Error occurrence)

Flag name	Address	IEC type address	Unit	Setting
_PID_ERROR (PID error occurrence)	K1211n	%KX19376 + n	BIT	Unavailable

If an error that discontinues running during PID control of 'n' th loop occurs, it indicates the error's occurrence. If an error generates warning, it is on; if normal, it is off. When an error occurs, PID control stops and MV is output as the min. output set in parameter. Also, if an error occurs, the error code is indicated in the error code area of a loop. For more information about type of error codes and measures, refer to 6.5. In the area as monitoring area, it is changed to the current run status by PLC although a user enters any value temporarily.

11) _PID_MV_BMPL (PID MV BuMPLess changeover)

Flag name	Address	IEC type address	Unit	Setting
_PID_MV_BMPL (PID MV BuMPLess changeover)	K1212n	%KX19392 + n	BIT	Available

This allows to not only determine an appropriate MV value through operation so that MV can continue smoothly when the corresponding PID loop changes from manual to auto output mode, but also reflect the MV value to the internal state so as to stabilize MV. This function shows an algorithm difference between single operation and cascade operation, but both operations are performed by this bit.

If the corresponding bit (in cascade operation, the corresponding bit of the master/slave loop is On) is On, Bumpless changeover is performed. If it is Off, The [Default] Bumpless changeover function is Disabled

(b) PID Flag area by loops

PID flag areas by loops are allocated between K1216 ~ K1855 and for totally 16 loops, each 40 words is allocated per loop. Therefore, the individual data areas of 'n' th loop are between K (1216+16*n) ~ K (1255+16*n). Every setting of the PID flag areas by loops may be changed during PID control operation. Once the settings are changed, they are applied from the next PID control cycle.

1) _PIDxx_SV (PID xx Loop SV setting)

Flag name	Address	IEC type address	Unit	Scope
_PIDxx_SV (PID xx Loop SV setting)	K1216+16*xx	%KW1216+16*xx	INT	-32,768 ~ 32,767

It sets/indicates the SV of PID control of 'xx' th loop. For more information about SV, refer to 6.2.3 PID control parameter setting. The available scope is between -32,768 ~ 32,767.

2) _PIDxx_T_s (PID xx Loop operation cycle)

Flag name	Address	IEC type address	Unit	Scope
_PIDxx_T_s (PID xx Loop operation cycle)	K1217+16*xx	%KW1217+16*xx	WORD	100 ~ 65,535

It sets/indicates the operation cycle of PID control of 'xx' th loop. For more information about operation cycle, refer to 6.2.3 PID control parameter setting. The available scope is between 100 ~ 65,535.

3) `_PIDxx_K_p` (PID xx Loop proportional constant)

Flag name	Address	IEC type address	Unit	Scope
<code>_PIDxx_K_p</code> (PID xx Loop proportional constant)	K1218+16*xx	%KD609+20*xx	REAL	Real number

It sets/indicates the proportional constant of PID control of 'xx' th loop. For more information about proportional constant, refer to 7.2.3 PID Control Parameter Setting. The available scope is real number (-3.40282347e+38 ~ -1.17549435e-38, 0, 1.17549435e-38 ~ 3.40282347e+38). If it is, however, set as 0 and lower, the PID control of a loop generates an error and does not work.

4) `_PIDxx_T_i` (PID xx Loop Integral time)

Flag name	Address	IEC type address	Unit	Scope
<code>_PIDxx_T_i</code> (PID xx Loop integral time)	K1220+16*xx	%KD610+20*xx	REAL	Real number

It sets/indicates integral time of PID control of 'xx' th loop. The available scope is real number. If it is set as 0 and lower, it does not execute integral control.

5) `_PIDxx_T_d` (PID xx Loop differential time)

Flag name	Address	IEC type address	Unit	Scope
<code>_PIDxx_T_d</code> (PID xx Loop differential time)	K1222+16*xx	%KD611+20*xx	REAL	Real number

It sets/indicates differential time of PID control of 'xx' th loop. The available scope is real number. If it is set as 0 and lower, it does not execute differential control.

6) `_PIDxx_d_PV_max` (PV change limit)

Flag name	Address	IEC type address	Unit	Scope
<code>_PIDxx_d_PV_max</code> (PV change limit)	K1224+16*xx	%KD612+20*xx	WORD	0 ~ 65,535

It sets the PV change limit of 'xx' th loop.

For more information about PV change limit, refer to 6.2.3 PID control parameter setting. If it is set as 0, the PV change limit function does not work.

7) `_PIDxx_d_MV_max` (MV change limit)

Flag name	Address	IEC type address	Unit	Scope
<code>_PIDxx_d_MV_max</code> (MV change limit)	K1225+16*xx	%KD610+20*xx	WORD	0 ~ 65,535

It sets the MV change limit of 'xx' th loop. For more information about MV change limit, refer to 6.2.3 PID control parameter setting. If it is set as 0, the MV change limit function does not work.

8) `_PIDxx_MV_max`, `_PIDxx_MV_min`, `_PIDxx_MV_man` (max. MV, min. MV, manual MV)

Flag name	Address	IEC type address	Unit	Scope
<code>_PIDxx_MV_max</code> (max. MV)	K1226+16*xx	%KW1226+16*xx	INT	-32,768 ~ 32,767
<code>_PIDxx_MV_min</code> (min. MV)	K1227+16*xx	%KW K1227+16*xx		
<code>_PIDxx_MV_man</code> (manual MV)	K1228+16*xx	%KW K1228+16*xx		

It sets the max. MV, min. MV and manual MV of 'xx' th loop. For more information about max. MV, min. MV and manual MV, refer to 6.2.3 PID control parameter setting. If the max. MV is set lower than the min. MV, the PID control loop generates an error and does not work.

9) `_PIDxx_PV` (prevent value)

Flag name	Address	IEC type address	Unit	Scope
<code>_PIDxx_PV</code> (present value)	K1229+16*xx	%KW1229+16*xx	INT	-32,768 ~ 32,767

It is the area that receives the present value of 'xx' th PID control loop. PV is the present status of the system to control and is normally saved into U device via input devices such as A/D input module if it is entered from a sensor. The value is used to execute PID operation by moving to `_PIDxx_PV` by means of commands like MOV.

10) `_PIDxx_PV_OLD` (PV of previous control cycle)

Flag name	Address	IEC type address	Unit	Scope
<code>_PIDxx_PV_OLD</code> (PV of previous control cycle)	K1230+16*xx	%KW1230+16*xx	INT	Unavailable

The area indicates the PV just before the xx th PID control loop. The flag, as a dedicated monitoring flag, would be updated by PLC although a user directly enters it.

11) `_PIDxx_MV` (Control MV)

Flag name	Address	IEC type address	Unit	Scope
<code>_PIDxx_MV</code> (control MV)	K1231+16*xx	%KW1231+16*xx	INT	Unavailable

The area shows the MV of 'xx' th PID control loop. As the area in which XGB built-in PID operation result is output every PID control cycle, it delivers the value in the area to U device every scanning by using commands like MOV in the program and outputs to D/A output module, operating a drive.

12) _PID00_ERR (Present error)

Flag name	Address	IEC type address	Unit	Scope
_PID00_ERR (present error)	K1232+16*xx	%KW1232+16*xx	DINT	Unavailable

The areas shows the current error of 'xx' th PID control loop. It is also used as an indicator about how much gap the present status has with a desired status and if an error is 0, it means the control system reaches a desired status exactly. Therefore, if control starts, error is quickly reduced at transient state and it reaches normal state, maintaining remaining drift as 0, it could be an ideal control system. The flag, as a dedicated monitoring, is updated although a user directly enters it.

13) _PIDxx_MV_p, _PIDxx_MV_i, _PIDxx_MV_d (P/I/D control components of MV)

Flag name	Address	IEC type address	Unit	Scope
_PIDxx_MV_p (MV proportional control component)	K1234+16*xx	%KD616+20*xx	REAL	Unavailable
_PIDxx_MV_i (MV integral control component)	K1236+16*xx	%KD617+20*xx		
_PIDxx_MV_d (MV differential control component)	K1238+16*xx	%KD618+20*xx		

It indicates 'n' th loop MV by classifying proportional control MV, integral control max. MV and differential control MV. The entire MV consists of the sum of these three components. The flag, as a dedicated monitoring, is updated although a user directly enters it.

14) _PIDxx_DB_W (DeadBand setting)

Flag name	Address	IEC type address	Unit	Scope
_PIDxx_DB_W (DeadBand setting)	K1240+16*xx	%KW1232+16*xx	WORD	0 ~ 65,535

It sets the deadband of 'xx' th loop. For more information about Deadband function, refer to 6.2.3 PID control parameter setting. If it is set as 0, the function does not work.

15) _PIDxx_Td_lag (Differential filter coefficient)

Flag name	Address	IEC type address	Unit	Scope
_PIDxx_Td_lag (differential filter coefficient)	K1241+16*xx	%KW1241+16*xx	WORD	0 ~ 65,535

It sets the differential filter coefficient of 'xx' th loop. For more information about differential filter coefficient, refer to 6.2.3 PID control parameter setting. If it is set as 0, the function does not work.

16) _PIDxx_PWM (PWM output junction setting)

Flag name	Address	IEC type address	Unit	Scope
_PID00_PWM (PWM output junction setting)	K1242+16*xx	%KW1242+16*xx	WORD	H'20 ~ H'3F

It sets the junction to which PWM output of 'xx' th loop is output. PWM output junction is valid only between H'20 ~ H'3F. If any other value is entered, PWM output does not work.

17) _PIDxx_PWM_Prd (PWM Output cycle setting)

Flag name	Address	IEC type address	Unit	Scope
_PIDxx_PWM_Prd (PWM output cycle setting)	K1243+16*xx	%KW1243+16*xx	WORD	100 ~ 65,535

It sets the PWM output cycle of 'xx' th loop. The available scope is between 100 ~ 65,535 at the unit of 0.1ms.

18) _PIDxx_SV_RAMP (SV ramp setting)

Flag name	Address	IEC type address	Unit	Scope
_PIDxx_SV_RAMP (SV ramp setting)	K1244+16*xx	%KW1244+16*xx	WORD	0 ~ 65,535

It sets the SV ramp value of 'xx' th loop. For more information about SV ramp of PV, refer to 6.2.3 PID control parameter setting. If it is set as 0, the function does not work.

19) _PIDxx_PV_Track (PV follow-up setting)

Flag name	Address	IEC type address	Unit	Scope
_PIDxx_PV_Track (PV follow-up setting)	K1245+16*xx	%KW1245+16*xx	WORD	0 ~ 65,535

It sets the PV follow-up SV of 'xx' th loop. For more information about PV follow-up, refer to 6.2.3 PID control parameter setting. If it is set as 0, the function does not work.

20) _PIDxx_PV_MIN, _PIDxx_PV_MAX (Min. PV input, Max. PV input)

Flag name	Address	IEC type address	Unit	Scope
_PIDxx_MV_p (MV proportional control component)	K1246+16*xx	%KW1246+16*xx	INT	-32,768 ~ 32,767
_PIDxx_MV_i (MV integral control component)	K1247+16*xx	%KW1247+16*xx		

It sets the min./max. PV of 'xx' th loop.

21) _PIDxx_ALM_CODE (Warning code)

Flag name	Address	IEC type address	Unit	Scope
_PIDxx_ALM_CODE (Warning code)	K1248+16*xx	%KW1248+16*xx	WORD	Unavailable

It indicates warning code if a warning occurs during 'xx' th loop run. The flag, as a dedicated monitoring, is updated although a user directly enters it. For more information about warning code, refer to 6.5.

22) _PIDxx_ERR_CODE (Error code)

Flag name	Address	IEC type address	Unit	Scope
_PIDxx_ERR_CODE (error code)	K1249+16*xx	%KW1249+16*xx	WORD	Unavailable

It indicates error code if an error occurs during 'xx' th loop run. The flag, as a dedicated monitoring, is updated although a user directly enters it. For more information about warning code, refer to 6.5.

23) _PIDxx_CUR_SV (SV of the present cycle)

Flag name	Address	IEC type address	Unit	Scope
_PIDxx_CUR_SV (SV of the present cycle)	K1250+16*xx	%KW1250+16*xx	INT	Unavailable

It indicates SV currently running of 'xx' th loop. If SV is changing due to SV ramp or PV follow-up function, it shows the currently changing PV. The flag, as a dedicated monitoring, is updated although a user directly enters it.

6.5 PID Instructions

It describes PID control commands used in XGB series. The command type of PID control used in XGB series built-in PID control is 4.

(1) PIDRUN

PIDRUN is used to execute PID control by loops.

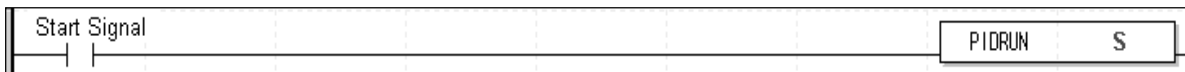

- Operand S means the loop no. to execute PID control and available only for constant(0~15).
- If start signal contact is on, the PID control of a loop starts.

(2) PIDCAS

PIDCAS is a command to execute CASCADE control.

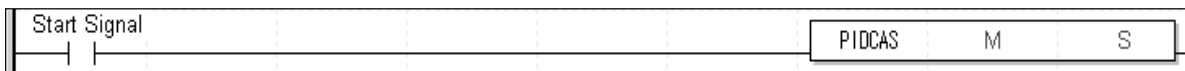

- Operand M and S mean master loop and slave loop respectively and available only for constant(0~15).
- If start signal contact is on, cascade control is executed through master loop and slave loop.

Cascade control is called a control method which is intended to increase control stability through quick removal of disturbance by connecting two PID control loops in series and is structured as follows.

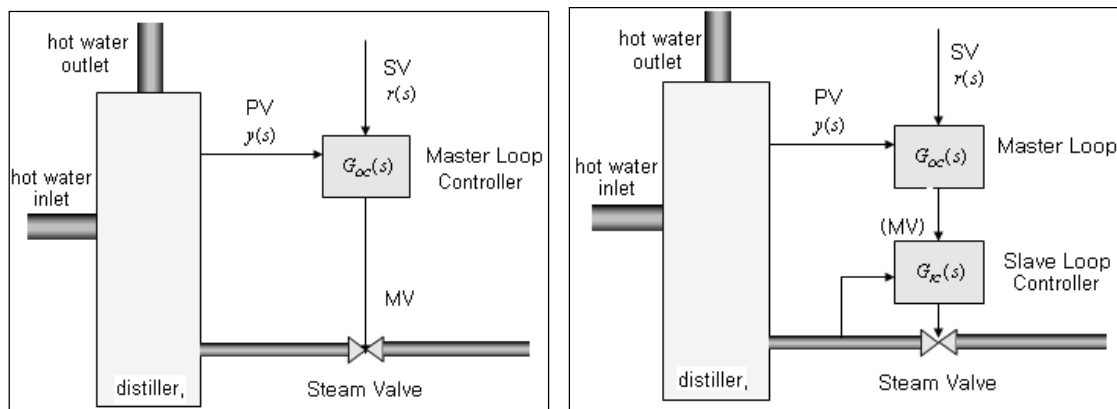

[Figure 6.13 Comparison of single loop control and cascade control]

Looking at the figure, it is found that cascade control contains slave loop control within external control loop. That is, the control output of external loop PID control is entered as SV of the internal loop control. Therefore, if steam valve suffers from disturbance in the figure, single loop PID control may not be modified until PV, $y(s)$ appears while cascade control is structured to remove any disturbance by the internal PID loop control before any disturbance that occurs in its internal loop affects the PV, $y(s)$, so it can early remove the influence from disturbance.

XGB internal PID control connects two PID control loops each other, making cascade control possible. At the moment, MV of external loop is automatically entered as the SV of internal loop, so it is not necessary to enter it through program.

(3) PIDHBD

PIDHBD is a command to execute the mixed forward/reverse E control.



- Operand F and R represent forward operation loop and reverse operation loop and available only for constant(0~15).
- If start signal contact is on, it starts the mixed forward/reverse operation from the designated forward/reverse loops.

The mixed forward/reverse control is called a control method to control forward operation control output and reverse operation control operation alternatively to a single control process. The XGB built-in PID control enables the mixed forward/reverse control by connecting two PID control loops set as forward/reverse operations. At the moment, it uses PIDHBD command. For more information about the command, refer to 6.2.5. The mixed forward/reverse run is executed as follows in the XGB built-in PID control.

(a) Commencement of mixed run

If PIDHBD command starts first, it starts reverse run when PV is higher than SV; it starts forward run if PV is lower than SV.

(b) Conversion of RUN direction

The conversion of run direction is executed according to the following principles. In case of forward operation run, it keeps running by converting to reverse operation once PV is over $SV + \text{DeadBand}$ value. At the moment, the DeadBand setting value uses the deadband of a loop set for forward operation. If PV is below $SV - \text{DeadBand}$ value during reverse operation, it also keeps running by converting to forward operation. In the case, the DeadBand setting uses the deadband of a loop set for reverse loop. It may be illustrated as 6.14.

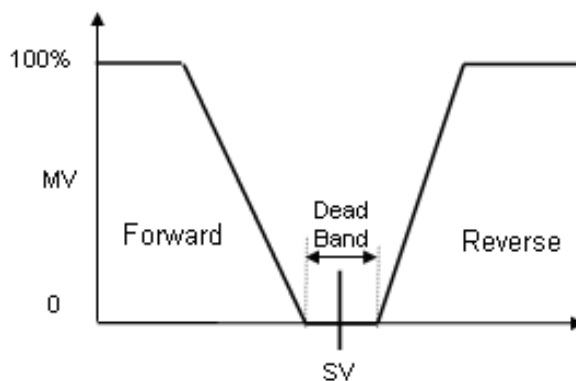

[Figure 6.14 Conversion of RUN direction in the mixed forward/reverse control]

- (c) At the moment, every control parameter uses the parameter of a loop set for forward operation while MV is output to MV output area of a loop of forward operation. Reversely, every control parameter uses the parameter of a loop set for reverse operation during reverse operation run while MV is also output to MV output area of reverse operation loop.

6.6 PID Auto-tuning

6.6.1 Basic Theory of PID Auto-tuning

It describes the function of PID auto-tuning.

The performance of PID controller is very different according to P, I, D coefficient. Generally, It is very difficult and takes long time to predict the system and set P, I, D coefficient because of non-periodical disturbance, interference of other control loop, dynamic characteristic of control system though the engineer is good at handling the PID controller. So auto-tuning that sets the PID coefficient automatically is very useful. Generally, there are many methods in setting the PID coefficient. Here, it will describe Relay Auto-tuning.

(1) PID coefficient setting by Relay auto-tuning

It makes critical oscillation by force and uses the width and period of oscillation to specify the PID coefficient. It applies max. output and min. output to control system for auto-tuning. Then, oscillation with steady period and steady width occurs around the Set value like figure 6.15, and it can calculate the boundary gain by using it like expression (6.3.1).

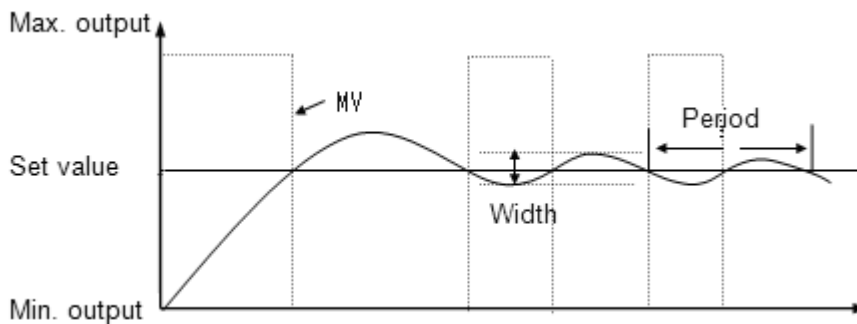

< Figure 6.15 Relay auto-tuning >

$$K_u = \frac{4 \times (\text{Max.output} - \text{Min.output})}{\pi \times \text{width}} \quad (6.4.1)$$

At this time, oscillation period is called boundary period. If boundary gain and period is specified, use table 6.9, Ziegler & Nichols tuning table to specify the PID coefficient. This Relay tuning is relatively simple to configure and easy to know the boundary gain and period so it is used frequently and XGB built-in PID auto-tuning uses this method.

Controller	Proportional gain (Kp)	Integral time(Ti)	Differential time(Td)
P	$0.5K_u$	-	-
PI	$0.45K_u$	$P_u / 1.2$	-
PID	$0.6K_u$	$P_u / 2$	$P_u / 8$

< Table 6.9 Ziegler & Nichols tuning table >

6.6.2 PID Auto-tuning Function Specifications

The specifications of the XGB series built-in PID auto-tuning function are summarized as in Table.

Item		Specifications
Scope of SV		INT (-32,768 ~ 32,767)
Scope of PV		INT (-32,768 ~ 32,767)
Scope of MV		INT (-32,768 ~ 32,767)
Error indication		Normal: error flag off Error: error flag off, error code occurs
AT direction setting		Forward/Reverse
Control cycle		100 ~ 65,536 (0.1msUnit)
Additional function	PWM output	Supportable
	Hysteresis	Supportable

[Table 6.10 Spec. of built-in PID auto-tuning function]

6.6.3 Auto-tuning Parameter Setting

To use the XGB series auto-tuning function, it is necessary to start it by using a command after setting auto-tuning parameters by loops in the parameter window. It explains the parameters to use auto-tuning function and how to set them.

(1) Auto-tuning parameter setting

To set the parameters of XGB series auto-tuning function, follow the steps.

- (a) If selecting parameter in project window and the built-in parameter, it shows the built-in parameter setting window as seen in below figure.

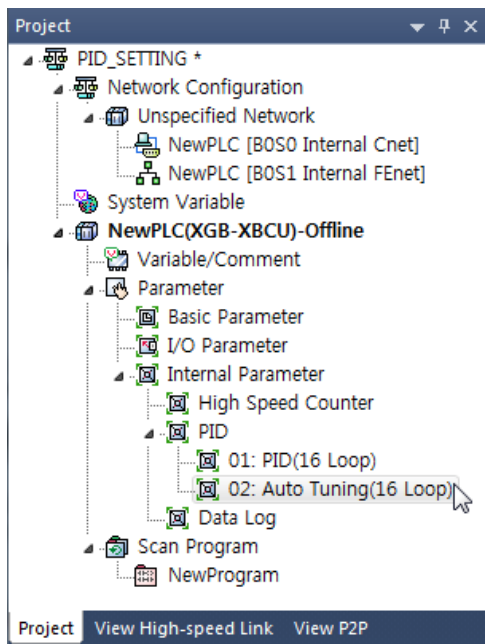

< Figure 6.16 Built-in parameter setting window >

(b) If selecting auto-tuning, it shows the parameter setting window as seen in Figure 6.17.

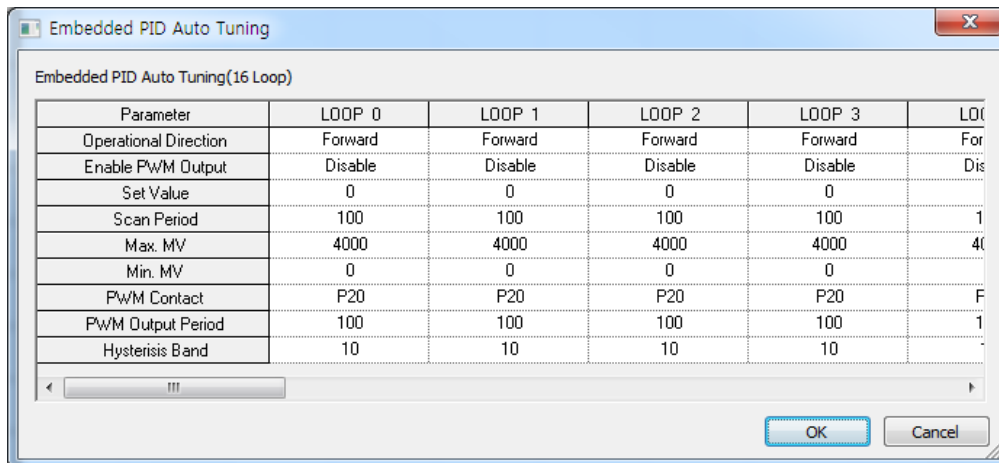

<Figure 6.17 Built-in auto-tuning function parameter setting window>

(c) Input items

Table shows the items to set in auto-tuning parameter window and the available scopes.

Items	Description	Scope
RUN direction	Set the run direction of auto-tuning.	Forward/reverse
PWM output enable	Set whether to set PWM output of MV enabled/disabled.	Disable/enable
SV	Set SV.	-32,768 ~ 32,767
Operation time	Set auto-tuning operation time.	100 ~ 65535
Max. MV	Set the max. MV in control.	-32,768 ~ 32,767
Min. mV	Set the min. MV in control.	-32,768 ~ 32,767
PWM junction designation	Designate the junction to which PWM output is output.	P20 ~ P3F
PWM output cycle	Set the output cycle of PWM output.	100 ~ 65,535
Hysteresis setting	Set the hysteresis of auto-tuning MV.	0 ~ 65,535

< Table 6.11 Auto-tuning function parameter setting items>

(2) Description of auto-tuning parameters and how to set them

(a) RUN direction

RUN direction is to set the direction of auto-tuning run of a loop. The available option is forward or reverse. The former (forward) means that PV increase when MV increases while the latter (reverse) means PV decreases when MV increases. For instance, a heater is a kind of forward direction system because PV (temperature) increases when output (heating) increases. A refrigerator is a kind of reverse direction system in which PV (temperature) decreases when output increases.

(b) PWM output enable

PWM output means an output method to turn a junction on – off with a duty proportional to control output calculated by a uniform output cycle. If PWM output is enabled, it realizes PWM output in accordance with PWM output cycle set in the parameter of PWM output junction (P20 ~ P3F) designated in the parameter. At the moment, the PWM output cycle follows the PWM output cycle separately set in auto-tuning operation cycle.

(c) SV

It sets the auto-tuning SV of a loop in question. Similar to PID control, physical values (temperature, flow rate, pressure and etc) of an object to control is not meaningful and instead, it should use the physical amount of an object to control after converting them into numerals. For instance, in order to control a system using a sensor that the output is 0V when its heating device temperature is 0°C while it is 10V when the temperature is 100°C as much as 50°C, it is necessary to set SV as 2000(as long as it uses AD input module XBE-AD04A).

(d) Operation time

It sets the cycle to execute operation for auto-tuning. The setting cycle is 0.1ms and available between 10ms ~ 6553.5ms (setting value: 100 ~ 65,535) while it is set at a unit of integer per 0.1ms.

(e) Max./min. MV

It sets the max./min. value of output for auto-tuning. The available scope is between -32,768 ~ 32,767. If the max. MV is set lower than min. MV, the auto-tuning function of a loop generates an error and does not work.

(f) Hysteresis setting

Looking at relay tuning in Figure 6.15, it shows it outputs the max. MV as auto-tuning starts but it converts to min. output as PV is over SV and then, it converts to the max. output as PV is lower than SV. However, if input PV contains noise components or reply components, auto-tuning ends by a slight vibration of PV around SV, yielding incorrect tuning result. To prevent it, hysteresis may be set. XGB auto-tuning converts output at SV + Hysteresis when PV increases or at SV - Hysteresis when it decreases once hysteresis is set. With it, it may prevent incorrect tuning by a slight vibration around SV.

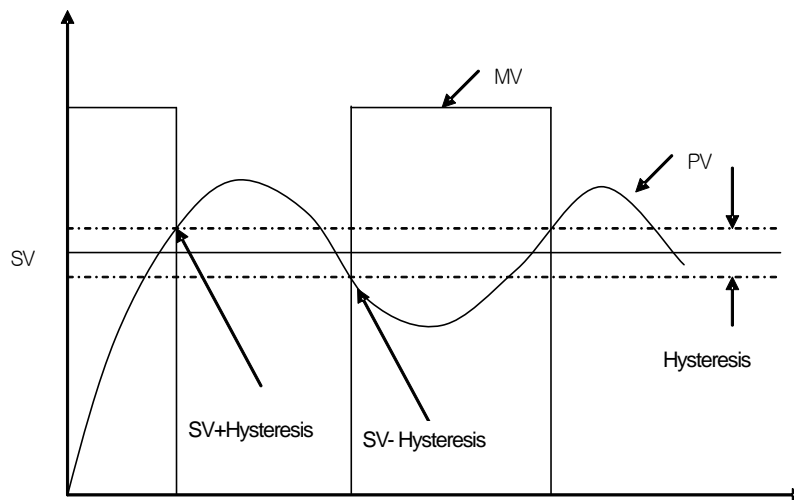

[Figure 6.16 Example of Hysteresis setting]

6.6.4 Auto-tuning Flags

The parameters set in the XGB series auto-tuning function are saved to the flash memory of basic unit. Such parameters are moved to K area for auto-tuning function as soon as PLC enters to RUN mode from STOP. Auto-tuning operation using auto-tuning command is achieved by data in K area. At the moment, if PLC is changed to RUN again after being changed to STOP, it takes the parameters in flash memory to K area, so the data changed in K area is lost. Therefore, to continuously apply the parameters adjusted in K area, it is necessary to write the parameters set in K area into flash memory by using WRT command. (In case of IEC type, APM_WRT function block)

(1) Auto-tuning flag configuration

The K area flags of XGB series auto-tuning function are summarized in Table 6.12.

Loops	K area	IEC type	Symbol	Data type	Default	Description
Common	K18560~F	%KX29696 ~%KX29711	_AT_REV	Bit	Forward	Auto-tuning direction(0:forward, 1:reverse)
	K18570~F	%KX29712 ~%KX29727	_AT_PWM_EN	Bit	Disable	PWM output enable(0:disable, 1:enable)
	K18580~F	%KX29728 ~%KX29743	_AT_ERROR	Bit	-	Auto-tuning error(0:normal,1:error)
	K1859	%KW1859	Reserved	WORD	-	Reserved area
Loop0	K1860	%KW1860	_AT00_SV	INT	0	AT SV – loop 00
	K1861	%KW1861	_AT00_T_s	WORD	100	AT operation cycle (T_s)[0.1msec]
	K1862	%KW1862	_AT00_MV_max	INT	4000	AT MV max. value limit
	K1863	%KW1863	_AT00_MV_min	INT	0	AT MV min. value limit
	K1864	%KW1864	_AT00_PWM	WORD	0	AT PWM junction setting
	K1865	%KW1865	_AT00_PWM_Prd	WORD	0	AT PWM output cycle
	K1866	%KW1866	_AT00_HYS_val	WORD	0	AT hysteresis setting
	K1867	%KW1867	_AT00_STATUS	WORD	0	AT auto-tuning status indication
	K1868	%KW1868	_AT00_ERR_CODE	WORD	0	AT error code
	K1869	%KD	_AT00_K_p	REAL	0	AT result proportional coefficient
	K1871	-	_AT00_T_i	REAL	0	AT result integral time
	K1873	-	_AT00_T_d	REAL	0	AT result differential time
	K1875	-	_AT00_PV	INT	0	AT PV
	K1876	-	_AT00_MV	INT	0	AT MV
	K1877~1879	%KW1877 ~%KW1879	Reserved	Word	0	Reserved area

[Table 6.12 K area flags for auto-tuning]

K1856 ~ K1859 areas (In case of IEC type, %KW1856~%KW1859) are the common bit areas for auto-tuning and each bit represents auto-tuning loop status respectively. K1860~K1879 areas save the setting and status of loop 0 as the K area for auto-tuning loop 0. In the area, the parameters such as PV, operation cycle and etc set in the built-in parameter window are saved and the XGB built-in auto-tuning function executes auto-tuning by the device values and saves the results into the K areas.

(2) Auto-tuning flag function

Each function of K area flags for XGB series auto-tuning is summarized as follows.

A) Common bit area

The area is a flag collecting operation setting and information consisting of bits to each 16 loop. Each bit of each word device represents the information of each loop.

1) `_AT_REV` (auto-tuning run direction setting)

Flag name	Address	IEC type address	Unit	Setting
<code>_AT_REV</code> (PID RUN direction setting)	K1856n	%KX29696 + n	BIT	Available

It determines the run direction of auto-tuning of 'n' th loop. If the bit is off, it is forward operation; if on, it is reverse operation.

2) `_AT_PWM_EN` (PWM output enable)

Flag name	Address	IEC type address	Unit	Setting
<code>_AT_PWM_EN</code> (PWM output enable)	K857n	%KX29713 + n	BIT	Available

It sets whether to output the auto-tuning MV of 'n' th loop as PWM output. If the bit is off, it is disabled; if on, it is enabled.

3) `_AT_ERROR` (Auto-tuning error occurrence)

Flag name	Address	IEC type address	Unit	Setting
<code>_PID_ERROR</code> (PID error occurrence)	K1858n	%KX29728 + n	BIT	Unavailable

It indicates the error in case an error that discontinues operation during auto-tuning of 'n' th loop occurs. If an error occurs, it is on; if normal, it is off. Once an error occurs, auto-tuning stops and the MV is output as the min. output set in the parameter. Also, if an error occurs, it indicates the error code in the error code area of a loop. For more information about error code types and measures, refer to 6.5. The area, as a dedicated monitor area, is updated although a user directly enters it.

B) Auto-tuning flag area by loops

The auto-tuning flag areas by loops are K1860 ~ K2179 and each 20 words per loop are allocated to totally 16 loops. Therefore, individual data area of 'n' th loop is between K (1860+16*n) ~ K (1879+16*n).

1) `_ATxx_SV` (auto-tuning xx Loop SV setting)

Flag name	Address	IEC type address	Unit	Scope
<code>_ATxx_SV</code> (AT xx Loop SV setting)	K1860+16*xx	%KW1860+16*xx	INT	-32,768 ~ 32,767

It sets/indicates the auto-tuning SV of 'xx' th loop.
The available scope is between -32,768 ~ 32,767.

2) `_ATxx_T_s` (Auto-tuning xx Loop operation cycle)

Flag name	Address	IEC type address	Unit	Scope
<code>_PIDxx_T_s</code> (Auto-tuning xx Loop operation cycle)	K1861+16*xx	%KW1861+16*xx	WORD	100 ~ 65,535

It sets/indicates the operation cycle of 'xx' th loop auto-tuning. The available scope is 100 ~ 65,535.

3) `_ATxx_MV_max`, `_ATxx_MV_min`(max. MV, min. MV)

Flag name	Address	IEC type address	Unit	Scope
<code>_PIDxx_MV_max</code> (Max. MV)	K1862+16*xx	%KW1862+16*xx	INT	-32,768 ~ 32,767
<code>_PIDxx_MV_min</code> (Min. MV)	K1863+16*xx	%KW1863+16*xx		

It sets max. MV and min. MV of 'xx' th loop respectively. If the max. MV is set lower than min. MV, the auto-tuning loop generates an error and does not work.

4) `_ATxx_PWM` (AT output junction setting)

Flag name	Address	IEC type address	Unit	Scope
<code>_AT00_PWM</code> (AT output junction setting)	K1864+16*xx	%KW1864+16*xx	WORD	H'20 ~ H'3F

It sets the junction that PWM output of 'xx' th loop is output. The PWM output junction is valid only between H'20 ~ H'3F (hex). If any other value is entered, PWM output does not work.

5) `_ATxx_PWM_Prd` (PWM output cycle setting)

Flag name	Address	IEC type address	Unit	Scope
<code>_ATxx_PWM_Prd</code> (PWM output cycle setting)	K1865+16*xx	%KW1865+16*xx	WORD	100 ~ 65,535

It sets the PWM output cycle of 'xx' th loop. The available scope is between 100 ~ 65,535 at the unit of 0.1ms.

6) `_ATxx_HYS_val` (Hysteresis setting)

Flag name	Address	IEC type address	Unit	Scope
<code>_ATxx_HYS_val</code> (Hysteresis setting)	K1866+16*xx	%KW1866+16*xx	WORD	0 ~ 65,535

It sets the hysteresis of 'xx' th loop. For more information about hysteresis function, refer to 6.3.3 Auto-Tuning Parameter Setting. If it is set as 0, it does not work.

7) `_ATxx_STATUS` (Auto-tuning status)

Flag name	Address	IEC type address	Unit	Scope
<code>_ATxx_STATUS</code> (Auto-tuning status)	K1867+16*xx	%KW1867+16*xx	WORD	Unavailable

It indicates the auto-tuning status of 'xx' th loop. If auto-tuning is in operation, it is 1(h0001); if completed, it is 128(h0080). In any other cases, it shows 0(h0000).

8) `_ATxx_ERR_CODE` (Error code)

Flag name	Address	IEC type address	Unit	Scope
<code>_ATxx_ERR_CODE</code> (Error code)	K1868+16*xx	%KW1868+16*xx	WORD	Unavailable

It indicates error code in case an error occurs during the auto-tuning of 'xx'th loop. The flag, as a dedicated monitor, is updated although a user directly enters it. For more information about error code, refer to 6.5.

9) `_ATxx_K_p`, `_ATxx_T_i`, `_ATxx_T_d` (AT result proportional coefficient, integral time, differential time)

Flag name	Address	IEC type address	Unit	Scope
<code>_ATxx_K_p</code> (proportional coefficient)	K1869+16*xx	%KD934+20*xx	Real	Unavailable
<code>_ATxx_T_i</code> (integral time)	K1871+16*xx	%KD1004+20*xx		
<code>_ATxx_T_d</code> (differential time)	K1873+16*xx	%K1005+20*xx		

The area indicates proportional coefficient, integral time and differential time calculated after the auto-tuning of 'xx' th loop is normally completed. The flag, as a dedicated monitoring, updated although a user directly enters it.

10) `_ATxx_PV` (PV)

Flag name	Address	IEC type address	Unit	Scope
<code>_ATxx_PV</code> (PV)	K1875+16*xx	%KW1875+16*xx	INT	-32,768 ~ 32,767

It is the area to receive PV of 'xx' th auto-tuning loop. PV is the present status of a system to control and in case of PID control, the entry from a sensor is saved into U device through input devices such as A/D input module and it moves the value to `_ATxx_PV` by using commands such as MOV every scanning, executing auto-tuning.

11) `_ATxx_MV` (Auto-tuning MV)

Flag name	Address	IEC type address	Unit	Scope
<code>_ATxx_MV</code> (auto-tuning MV)	K1876+16*xx	%KW1876+16*xx	INT	Unavailable

It is the area to output MV of 'xx' th auto-tuning loop. Every auto-tuning cycle, it saves XGB auto-tuning and it delivers the value in the area by using commands like MOV in a program and operates a drive every scanning.

6.6.5 Auto-tuning Instructions

The commands used in XGB series auto-tuning are as follows.

1) PIDAT

PIDAT is a command to execute auto-tuning by loops.

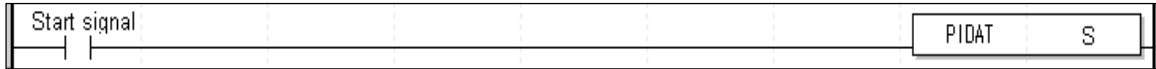

- Operand S means the loop no. to execute auto-tuning and available only for constant(0~15).
- If start signal contact is on, the PID control of a loop starts.

6.7 Example Programs

The paragraph explains example programs regarding the directions of XGB built-in PID function. The example programs are explained with water level system as illustrated in 6.17.

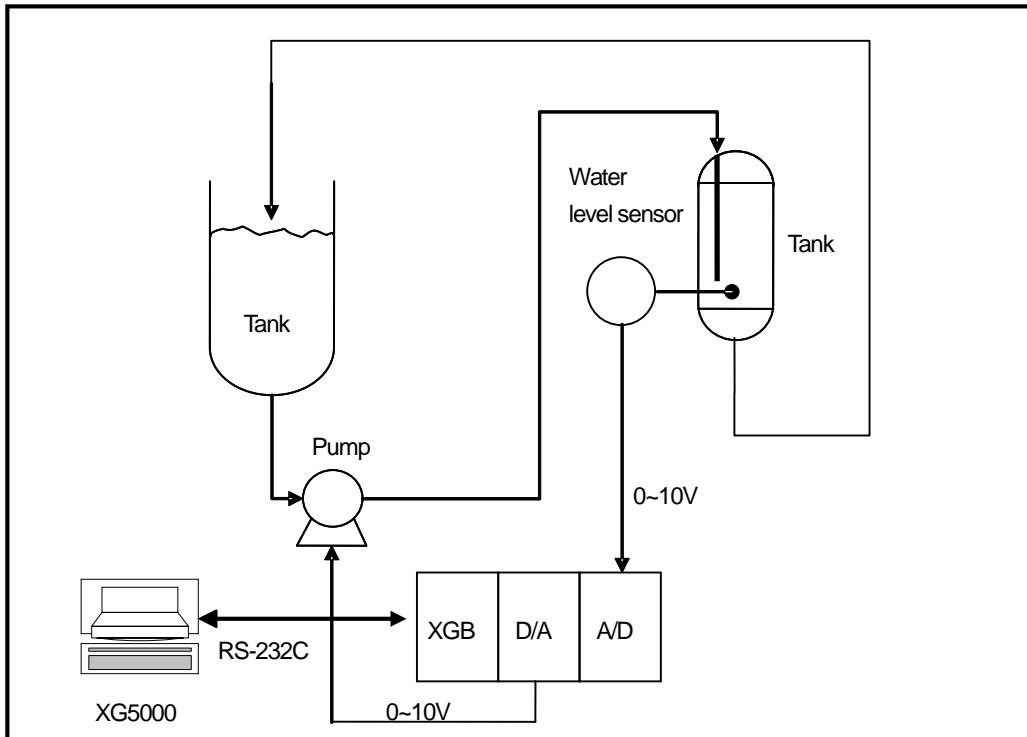

[Figure 6.17 Example of water level control system]

6.7.1 Example System Structure

The example system in figure is an example of a system to control a pail's water level to a desired level. The pail's water level is sensed by a water level sensor and entered to A/D input module while PID control operation result, MV is output to a pump through D/A output module, controlling a pump's rotation velocity, regulating the water amount flowing into a pail and regulating the water level as desired. Each mechanism is explained as follows.

(1) XGB basic unit

The XGB basic unit operates by PID control operating PID control operation. It receives PV from A/D input module (XBF-AD04A), executes the built-in PID control operation, output the MV to D/A (XBF-DV04A) and executes PID control.

(2) A/D input module (XBF-AD04A)

It functions as receiving PV of an object to control from a water level sensor and delivering it to basic unit. XBF-AD04A is a 4CH analog input module and settings of analog input types and scopes can be changed in the I/O parameter setting window appeared when selecting I/O parameter in the parameter item of project window. For more information, refer to Analog I/O Module.

(3) D/A output module (XBF-DV04A)

It functions as delivering control MV from basic unit to a drive (pump). XBF-DV04A is a 4CH analog voltage output module and ranges 0 ~ 10V. For detail setting, refer to Analog I/O Module.

(4) Water Level Sensor

A water level sensor plays a role to deliver the PV of an object to control to XGB by measuring the water level of a pail and outputting it within 0 ~ 10V. Since the types and output scope of water level sensors varies, the output scope of a sensor should be identical with that of A/D input module's input scope. The example uses a water level sensor outputting between 0 ~ 10V.

(5) Drive (pump)

A drive uses a pump that receives control output of XGF-DV04A and of which rotation velocity is variable. For accurate PID control, the output scope of XBF-DV04A (0~10V) should be same with that of a pump's control input. The example uses a pump that receives its control input between 0 ~ 10V.

6.7.2 Example of PID Auto-tuning

Here, with examples, it explains how to calculate proportional constant, integral time and differential time by using PID auto-tuning function

(1) PID auto-tuning parameter setting

- (a) If double-clicking Parameter – Built-in Parameter – PID – Auto-tuning parameter in the project window, it opens up the auto-tuning parameter setting window as illustrated in Figure 6.18.

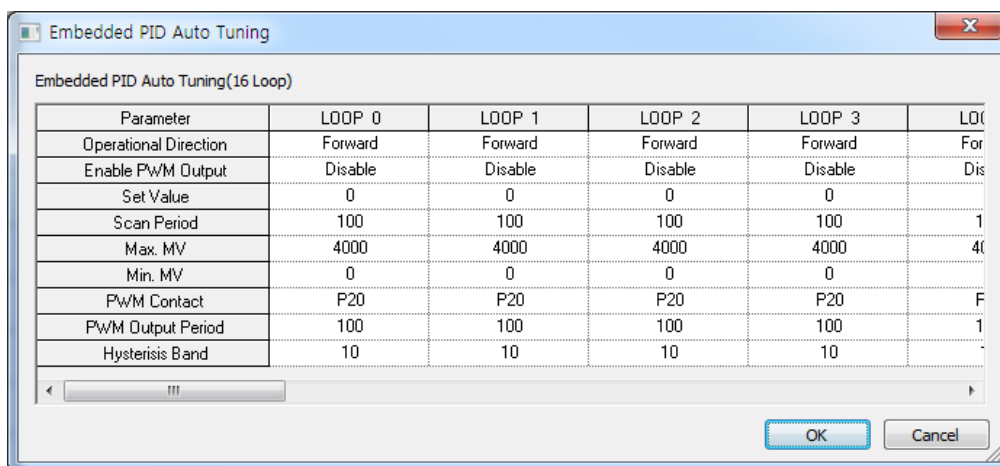

[Figure 6.18 Auto-tuning parameter setting window]

- (b) Set each parameter and click OK.

In the example, Loop 0 is set as follows.

- RUN direction: forward
 - Since in the system, water level is going up as MV increases and pump's rotation velocity increases, it should be set as forward operation.
- PWM output: disabled
 - In the example, auto-tuning using PWM is not executed. Therefore, PWM output is set as disabled.
- SV: 1000(2.5V)
 - It shows an example in which XBF-AD04A is set as the voltage input of 0~10V.

- Max. MV: 4000
- Max. MV is set as 4000. If MV is 4000, XBF-DV04A outputs 10V.
- Min. MV: 0
- Min. MV is set as 0. If MV is 0, XBF-DV04A outputs 0V.
- PWM junction, PWM output cycle
- It is not necessary to set it because the example does not use PWM output.
- Hysteresis setting: 10

(2) A/D input module parameter setting

(a) If double-clicking Parameter – I/O parameter, it opens up the setting window as illustrated in figure 6.19.

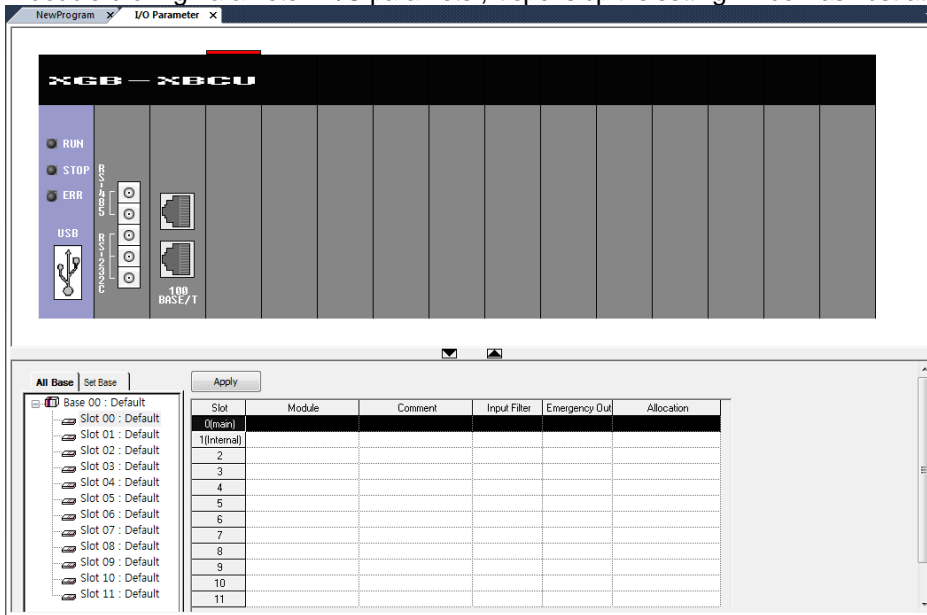

[Figure 6.19 I/O parameter setting window]

(b) If selecting A/D module for a slot in A/D input module, it opens up the setting window as illustrated in Figure 6.20.

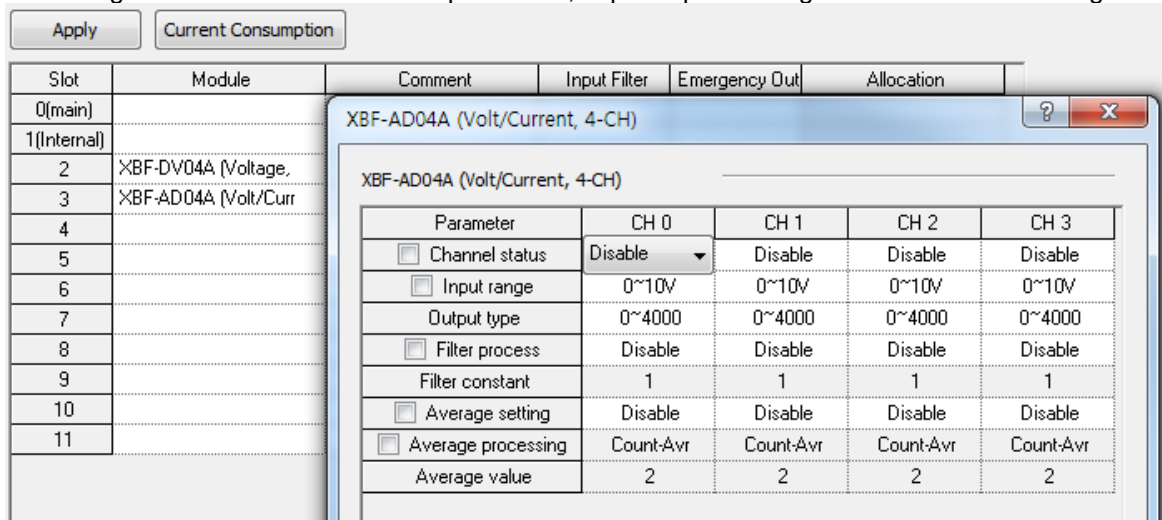

[Figure 6.20 A/D input mode setting window]

(c) Check A/D Module operation parameter and click OK. The example is set as follows.

- RUN CH: CH0 RUN
 - The example receives the water level sensor input as CH0.
- Input scope: 0 ~ 10V
 - Set XBF-AD04A input scope as 0 ~ 10V so that it should be identical with the output scope of water level sensor.
- Output data type: 0 ~ 4000
 - It converts the input 0 ~ 10V to digital value from 0 ~ 4000 and delivers it to basic unit.
 - In the case, the resolving power of digital value 1 is $10/4000 = 2.5\text{mV}$
- Filter process, averaging: disabled
 - The example sets the input values in order that filter process and averaging are not available.
 - For more information about each function, refer to 12 Analog I/O Module.

(3) D/A Output Module Parameter setting

- (a) Set the parameter of D/A output module(XBF-DV04A) that output MV to a drive.
How to set them is as same as A/D input module. In the example, it is set as follows.

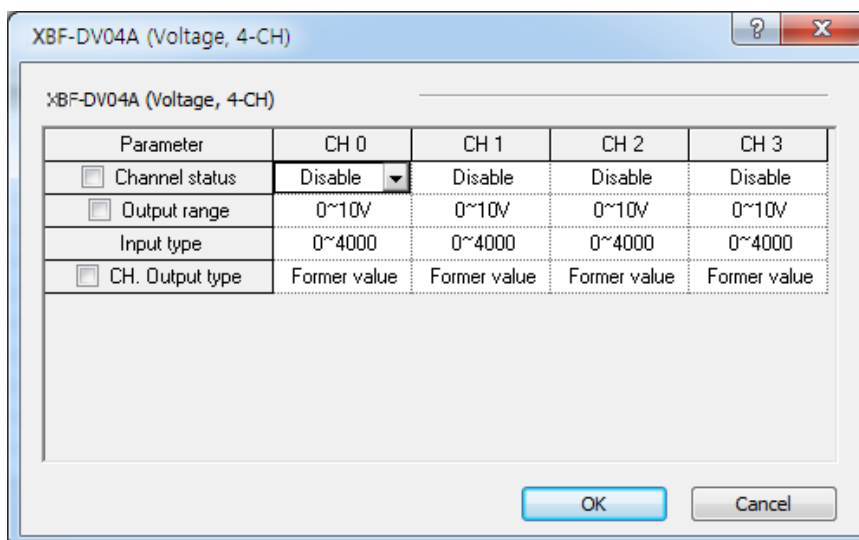

- RUN CH: CH0 RUN
 - In the example, MV is output as CH0 of D/A output module.
- Output scope : 0 ~ 10V
- Input data type: 0 ~ 4000

(4) Example of PID Auto-tuning program

The example of PID auto-tuning program is illustrated as Figure 6.21.

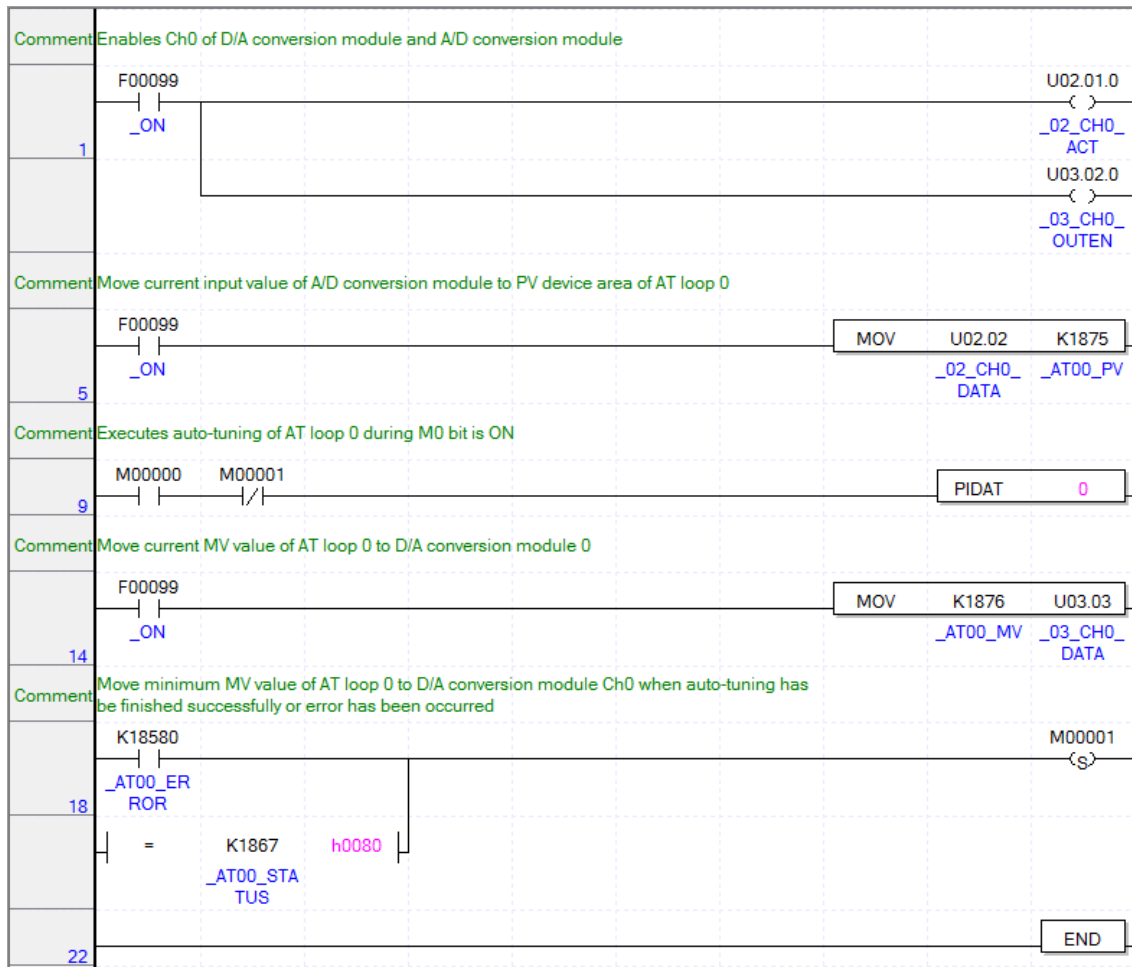

< Figure 6.21 Auto-tuning example program >

(a) Devices used

Device	Data type	Application
F0099	BIT	It is always on, so it readily operates once PLC is RUN.
U02.01.0	BIT	It starts operation of CH0 of Slot 2 A/D input module.
U03.02.0	BIT	It starts operation of CH0 of Slot 3 D/A output module.
U02.02	INT	PV entered to A/D input module.
U03.03	INT	MV entered to D/A output module.
K1875	INT	Device to which PV is entered for LOOP 0 auto-tuning
K1876	INT	Device to which auto-tuning MV of LOOP 0 is output.
K1867	WORD	Device to which auto-tuning status indicates.
K18580	BIT	Junction that is on once auto-tuning has an error.
K1863	INT	Min. MV of auto-tuning designated in parameter.

(b) Program explanation

- 1) Since F0099(always on) is ON if PLC is converted form STOP to RUN, CH0 of A/D and D/A starts operating.
- 2) At the moment, PV entered to CH0 of A/D is moved to K1875, the input device of PV and saved accordingly.

- 3) Once M0000 junction is on, the auto-tuning of loop 0 starts.
 - 4) The auto-tuning MV of loop 0 that is output by PIDAT command is output to D/A output module by line 14 MOV command.
 - 5) If auto-tuning is complete or there is any error during auto-tuning, M0001 junction is set, blocking operation of PIDAT command and it outputs min. MV set in parameter to D/A output module.
- (c) Monitoring and changing PID control variables using K area
- In XGB series built-in auto-tuning, it can monitor and change RUN status of auto-tuning by using K area allocated as fixed area by loops.

1) Variable registration

If selecting “Register in Variable/Description” by right clicking in the variable monitor window, “Variable/Device Selection” window appears. Select “Item” as PID, deselect “View All” and enter 0(means loop number) in “Parameter No”, K area device list to save every setting and status of loop 0 appears as shown Figure 6.22. Then, if selecting a variable to monitor and clicking “OK”, a selected device is registered to variable monitor window as illustrated in Figure 6.23. Through the monitor window, a user can monitor auto-tuning run status or change the settings.

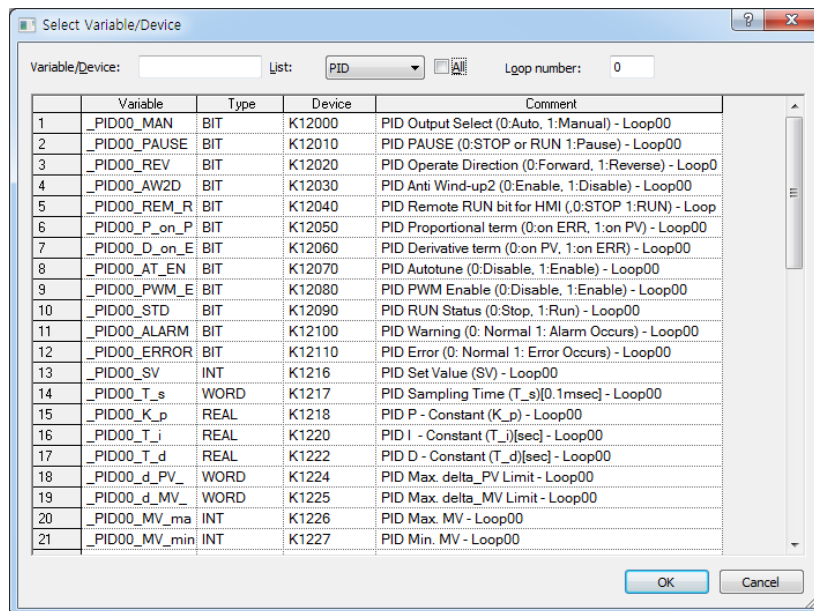

[Figure 6.22 Variable registration window]

	PLC	Program	Device/Variable	Value	Type	Variable/Device	Comment
1	NewPLC	<GLOBAL>	K12000	10	BIT	_PID00_MAN	PID Output Select (0:Auto, 1:Manual) - Loop00
2	NewPLC	<GLOBAL>	K12010	10	BIT	_PID00_PAUSE	PID PAUSE (0:STOP or RUN 1:Pause) - Loop00
3	NewPLC	<GLOBAL>	K12020	10	BIT	_PID00_REV	PID Operate Direction (0:Forward, 1:Reverse) - Loop00
4	NewPLC	<GLOBAL>	K12030	10	BIT	_PID00_AW2D	PID Anti Wind-up2 (0:Enable, 1:Disable) - Loop00
5	NewPLC	<GLOBAL>	K12040	10	BIT	_PID00_REM_RUN	PID Remote RUN bit for HMI (0:STOP 1:RUN) - Loop00
6	NewPLC	<GLOBAL>	K12050	10	BIT	_PID00_P_on_PV	PID Proportional term (0:on ERR, 1:on PV) - Loop00
7	NewPLC	<GLOBAL>	K12060	10	BIT	_PID00_D_on_ERR	PID Derivative term (0:on PV, 1:on ERR) - Loop00
8	NewPLC	<GLOBAL>	K12070	10	BIT	_PID00_AT_EN	PID Autotune (0:Disable, 1:Enable) - Loop00
9	NewPLC	<GLOBAL>	K12080	10	BIT	_PID00_PWM_EN	PID PWM Enable (0:Disable, 1:Enable) - Loop00

[Figure 6.23 Auto-tuning variables registered]

(5) Observing RUN status by using trend monitor function

Since it is possible to monitor the operation status of XGB series built-in auto-tuning graphically, it is useful to monitor the operation status of auto-tuning clearly.

(a) If selecting Monitor – Trend monitor menu, it shows the trend monitor window as illustrated in Figure 6.24.

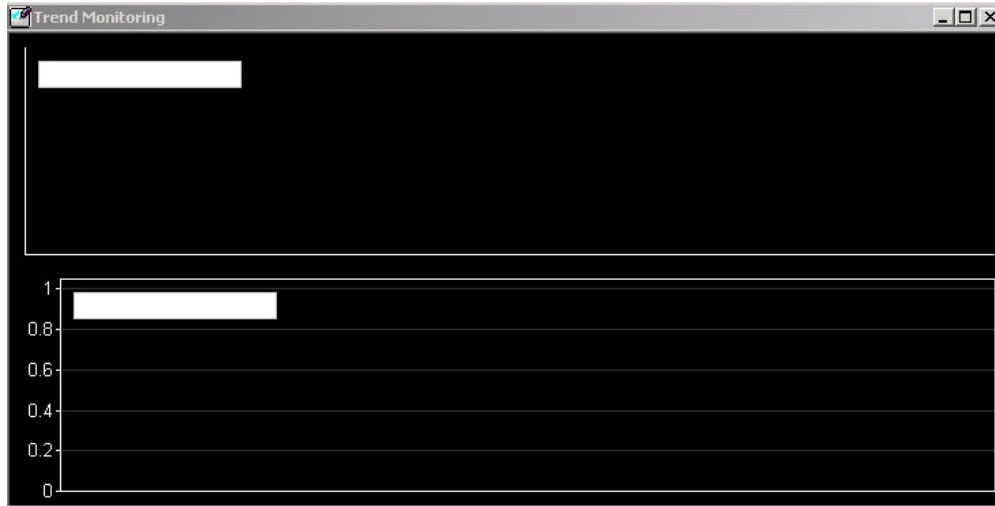

[Figure 6.24 Trend Monitor window]

(b) If right-clicking trend setting, a user can select a variable to monitor as illustrated in Figure 6.25.

ID	Device	Variable Name	Type
1			

[Figure 6.25 window to register trend monitor variable]

(c) For more information about trend monitor, refer to “XG5000 Use’s Manual.”

6.7.3 Stand-alone Operation After PID Auto-tuning

Here, with example, it explains how to execute PID control followed by PID auto-tuning.

(1) PID auto-tuning parameter setting

- PID auto-tuning parameters are set as same as examples of 6.4.2 Example of PID Auto-tuning.

(2) Setting parameters of A/D input module and D/A output module

- Set the parameters of A/D input module and D/A output module as same as the example in 6.4.2 Example of PID Auto-tuning.

(3) PID parameter setting

- (a) If double-clicking Parameter – Built-in Parameter – PID – PID Parameter, it shows the built-in PID parameter setting window as seen in Figure 6.26.

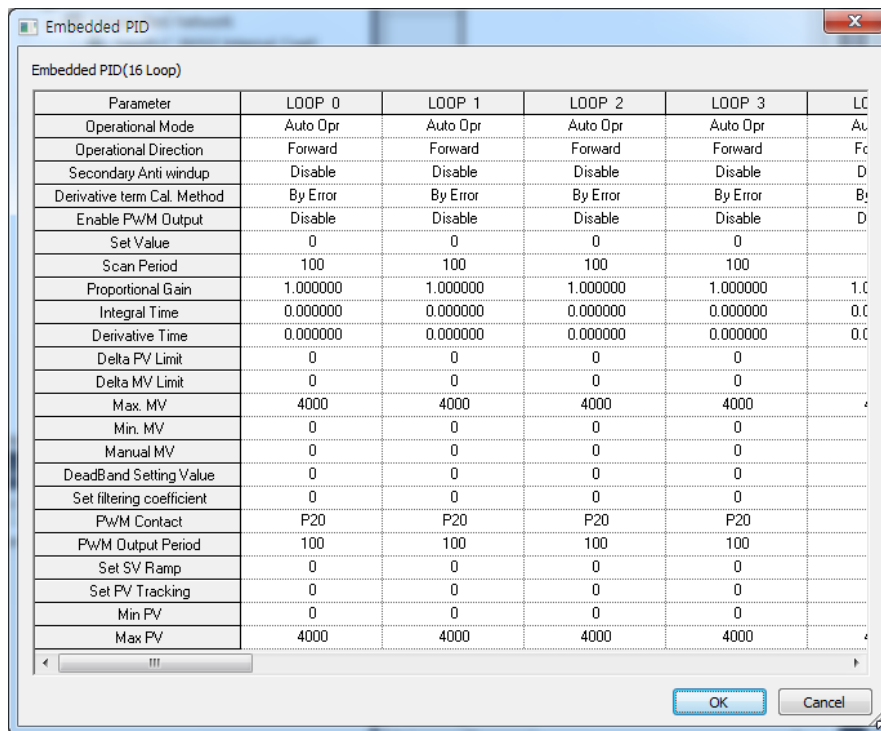

[Figure 6.26 Auto-tuning parameter setting window]

- (b) Set each parameter and click OK.

In the example, Loop 0 is set as follows.

- RUN mode: automatic
 - Set as automatic in order that PID control is executed as the built-in PID operation outputs MV.
- RUN direction: forward
 - Since in the system, water level is going up as MV increases and pump's rotation velocity increases, it should be set as forward operation.
- PWM Output: disabled
 - In the example, auto-tuning using PWM is not executed. Therefore, PWM output is set as disabled.

- SV: 1000(2.5V)
 - It shows an example in which XBF-AD04A is set as the voltage input of 0~10V
- Operation cycle: 1000
 - In the example, it is set that PID control is executed every 100ms.
- Proportional gain, integral time and differential time
 - It should be initially set as 1,0,0 because PID auto-tuning results is used with PID constant.
- Max. MV: 4000
 - Max. MV is set as 4000. If MV is 4000, XBF-DV04A outputs 10V.
- DeadBand: 0
 - It is set as 0 because the example does not use DeadBand function.
- Differential filter setting: 0
 - it is also set as 0 because the example does not use differential filter.
- Min. MV: 0
 - Min. MV is set as 0. If MV is 0, XBF-DV04A outputs 0V.
- PWM junction, PWM output cycle
 - It is not necessary to set them because the example does not use PWM output.
- SV ramp, PV follow-up: 0
 - It is not necessary to set SV ramp and PV follow-up because the example does not use them.
- Min. PV, Max. PV: 0
 - Set them as 0 and 4000 respectively so that it could be identical with A/D input module's input scope.

(c) Example of PID control program after PID auto-tuning

The program example for PID auto-tuning is illustrated as Figure 6.27.

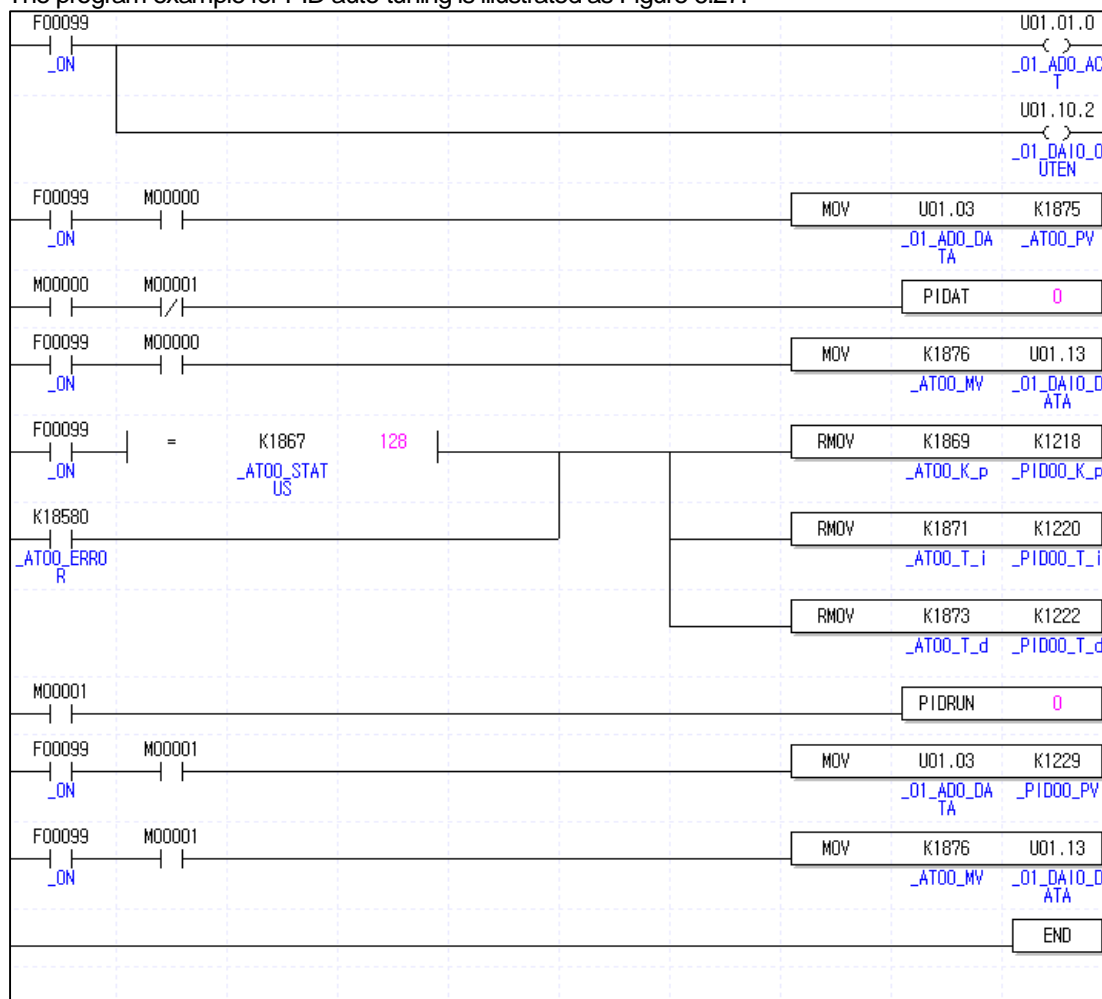

[Figure 6.27 Example program of PID control after auto-tuning]

1) Devices used

Device	Data type	Application
F0099	BIT	It is always on, so it readily operates once PLC is RUN.
U01.01.0	BIT	It starts operation of CH0 of Built-in A/D input module.
U01.10.2	BIT	It starts operation of CH0 of Built-in D/A output module.
U01.03	INT	PV entered to A/D input module.
U01.13	INT	MV entered to D/A output module.
K1875	INT	Device to which PV is entered for LOOP 0 auto-tuning
K1876	INT	Device to which auto-tuning MV of LOOP 0 is output.
K1867	WORD	Device to which auto-tuning status indicates.
K18580	BIT	Junction that is on once auto-tuning has an error.
K1869	REAL	proportional coefficient calculated after the auto-tuning
K1871	REAL	integral time calculated after the auto-tuning.
K1873	REAL	differential time calculated after the auto-tuning.
K1218	REAL	proportional coefficient of PID designated in parameter.
K1220	REAL	integral time of PID designated in parameter.
K1222	REAL	differential time of PID designated in parameter.
K1229	INT	Device to which PV is entered for Loop 0 PID control
K1876	INT	Device to which MV of loop 0 PID control is output.

2) Program explanation

- a) Since F0099 (always on) is ON if PLC is converted from STOP to RUN, CH0 of A/D and D/A starts operating.
- b) Once M0000 junction is on, the auto-tuning of loop 0 starts. At the moment, PV entered to CH0 of A/D is moved to K1875, the PV input device of loop 0 and saved accordingly.
- c) The auto-tuning MV of Loop 0 output by PIDAT command is output to D/A output module by line 11, MOV command.
- d) Once auto-tuning is complete, it moves P, I, D coefficients generated from auto-tuning to the input devices of P, I and D, K1218, K1220 and K1222, sets M001 and starts the operation of PID loop 0.

6.8 Error / Warning Codes

It describes error codes and warning codes of the XGB built-in PID function. The error codes and warning codes that may occur during use of the XGB built-in PID function are summarized as table. If any error or warning occurs, remove potential causes of the error by referring to the tables.

6.8.1 Error Codes

Error codes	Indications	Measures
H'0001	MV_MIN_MAX_ERR	It occurs when max. MV is set lower than min. MV. Make sure to set max. MV larger than min. MV.
H'0002	PV_MIN_MAX_ERR	It occurs when max. PV is set lower min. Pv. Make sure to set max. PV larger than min. PV.
H'0003	PWM_PERIOD_ERR	It occurs when the period of auto tuning or PID operation loop is set under 100(10ms). Make sure to set output period more than 100.
H'0004	SV_RANGE_ERR	It occurs when SV is larger than PV at the start time of auto-tuning if auto-tuning is forward or when SV is larger than PV at the start time of auto-tuning if auto-tuning is reverse.
H'0005	PWM_ADDRESS_ERR	It occurs when the junction designated as PWM output junction is beyond between P20 ~ P3F.
H'0006	P_GAIN_SET_ERR	It occurs when proportional constant is set lower than 0.
H'0007	I_TIME_SET_ERR	It occurs when integral time is set lower than 0.
H'0008	D_TIME_SET_ERR	It occurs when differential time is set lower than 0.
H'0009	CONTROL_MODE_ERR	It occurs when control mode is not P, PI, PD or PID.
H'000A	TUNE_DIR_CHG_ERR	It occurs when operation direction is changed during auto-tuning. Never attempt to change operation direction during auto-tuning.
H000B	PID_PERIOD_ERR	It occurs when period of operation is smaller than 100 (10ms) at Auto-tuning or PID operation. Make sure to set period of operation larger than 100.
H000C	HBD_WRONG_DIR	In mixed operation, It occurs when the direction parameter of forward operation set to reverse operation or the direction parameter of reverse operation set to forward operation. Make sure set to appropriate direction each loop.
H000D	HBD_SV_NOT_MATCH	In mixed operation, it occurs when the Set value of each loop is not concurrent. Make sure set to Set value concurrently.

[Table 6.13 : PID error codes]

6.8.2 Warning Codes

Error codes	Indications	Measures
H'0001	PV_MIN_MAX_ALM	It occurs when the set PV is beyond the min./max. PV.
H'0002	PID_SCANTIME_ALM	It occurs when PID operation cycle is too short. It is desirable to set PID operation cycle longer than PLC scan time.
H'0003	PID_dPV_WARN	It occurs when the PV change of PID cycle exceeds PV change limit.
H'0004	PID_dMV_WARN	It occurs when the PV cycle MV change exceeds MV change limit.
H'0005	PID_MV_MAX_WARN	It occurs when the calculated MV of PID cycle exceeds the max. MV.
H'0006	PID_MV_MIN_WARN	It occurs when the calculated MV of PID cycle is smaller than the min. MV

[Table 6.14 : PID error codes]

Part 3. Embedded Positioning

Chapter 1 Overview

Part 3 describes the specification, method to use each positioning function, programming and the wiring with external equipment of embedded positioning function.

1.1 Characteristics

The characteristics of positioning module are as follows.

(1) The positioning function is embedded in XBC-DN32UP/ XBC-DP32UP/XBC-DR28UP PLC.

(2) Various positioning control function

It has various functions needed for positioning system such as positioning control, speed control etc.

The operation data including positioning address and operation method, operation pattern is available to set up to 400 for each axis. With this operation data, positioning for each axis is available.

(a) Various sing-axis operations are available.

- 1) Position Control
- 2) Speed Control
- 3) Feed Control
- 4) Multi-axis Synchronous Start
- 5) Point Operation

(b) Various Multi-axis Operations are available.

- 1) Circular arc Interpolation (up to 2 groups, 2 axes per one group)
- 2) Linear Interpolation (up to 4 axes)
- 3) Helical Interpolation
- 4) Ellipse Interpolation

(c) Switching Control in operation is available.

- 1) Position/Speed Control Switching
- 2) Speed/Position Control Switching.

(d) Cam Control is available.

It is available to create up to 7 kinds of cam data with various cam profile of XG-PM Software.

e) Various Homing Control Function.

1) 7 methods are available for Homing.

- a) Origin detection after DOG Off
- b) Origin detection after deceleration in case of DOG On
- c) Origin detection by the HOME and upper/lower limit
- d) Origin detection by DOG
- e) High speed Origin detection
- f) Origin detection by upper/lower limit
- g) Origin detection by HOME

2) It is Available to set the origin of machine without homing by setting the floating origin

(f) For the Acceleration/Deceleration method, it is available to select trapezoid or S curve.

(3) High speed start process .

The start time of positioning is less than 5 ms(1 ms when continuous operation is not used).

In addition, there is no delay time between axes in synchronous start and interpolation start.

(4) Easy maintenance.

Various data such as operation data, operation parameter are saved on FLASH Memory in PLC. Therefore, data will be saved permanently. Max writing count of the flash memory is 100,000.

(5) Self-diagnosis, monitoring and test are available with XG-PM software package.

- (a) Monitoring (Module & External Input/output Signal) Function
- (b) Trace Function
- (c) Trend Function
- (d) Reading and Saving Module Parameter/Operation Data
- (e) Creation of Cam Data
- (f) Providing details about errors and the solution for it
- (g) Print Function of various forms
- (h) Editing operation data in Excel program is available

Notes

For using positioning, set XBF-PD04E in XG5000 I/O parameter.. Embedded Positioning parameter can be set in XG-PM.

Chapter 1 Overview

1.2 Purpose of Positioning Control

The purpose of positioning is to transfer the objects (tools etc.) with setting speed from the current position and stop them on the setting position correctly. And high precision positioning is available by positioning pulse string signal as it is connected to various control driving devices such as servo driving devices or stepping motor.

In application, it can be used widely with engineering machine, semiconductor assembly machine, grinder, small machine center, lifter etc.

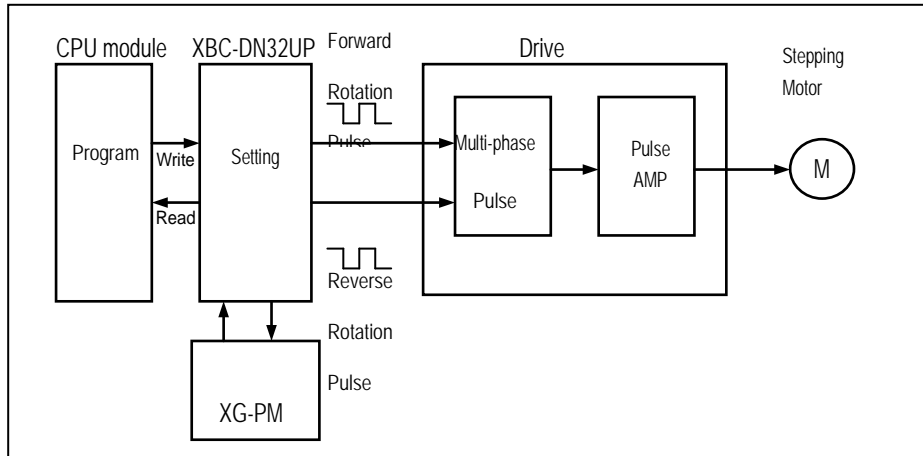

Fig. 1.1 Overview of Position Control for Stepping Motor

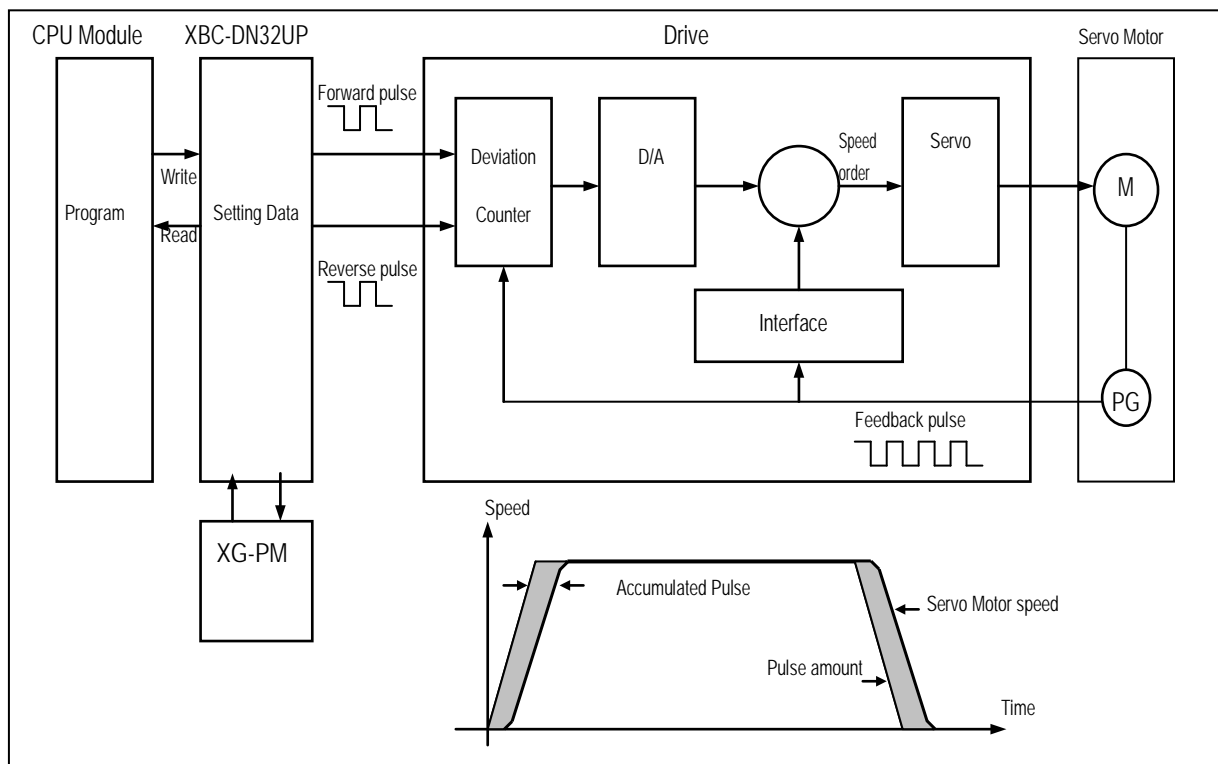
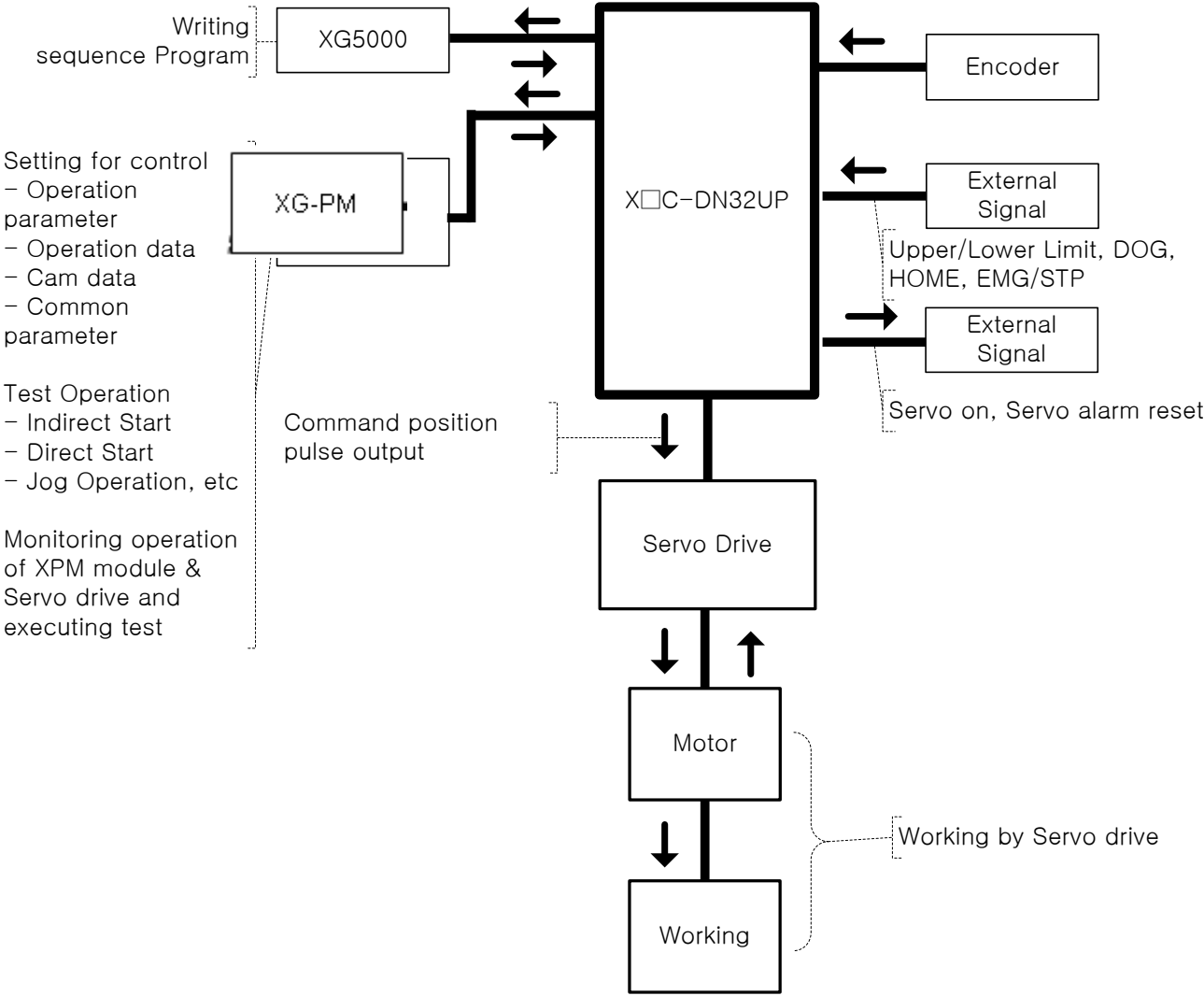

Fig. 1.2 Overview of Position Control for Servo Motor

1.3 Signal Flow of Embedded Positioning

The flow of PLC system using the embedded positioning is as follows.



1.4 Function overview of embedded positioning

Describe Representative functions of APM module (Coordinate & Linear Interpolation, Circular Interpolation & Stop) briefly.

1.4.1 Position Control

Execute positioning control for the designated axis from the starting position(current position) to goal position(the position to move to).

(1) Control by Absolute coordinates

- Execute positioning control from starting position to goal position designated in positioning data
- Positioning control is executed based on origin designated in homing
- Moving direction is decided by starting position and goal position.
 - Starting Position < Goal Position : Forward Positioning Operation
 - Starting Position > Goal Position : Reverse Positioning Operation

[Example]

■ Starting Position : 1000

■ Goal Position : 8000

Value of Forward movement is 7000 ($7000=8000-1000$)

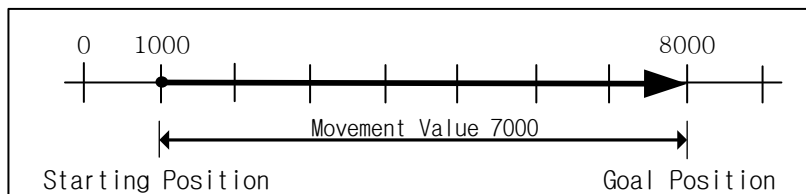

(2) Control by Incremental Coordinates

- Execute positioning control from starting position as much as goal movement value.

The difference from absolute coordinates control is that the goal position is movement value, not position value.
- Moving direction depends on sign of movement value.
 - Positive value (+ or 0) : Positioning operation with forward direction
 - Negative value (-) : Positioning operation with reverse direction

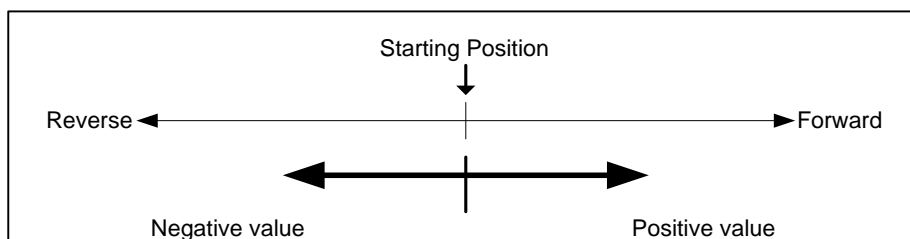

[Example]

- Starting Position : 5000
- Goal Position : -7000

In this condition, it moves reversely and stops at -2000.

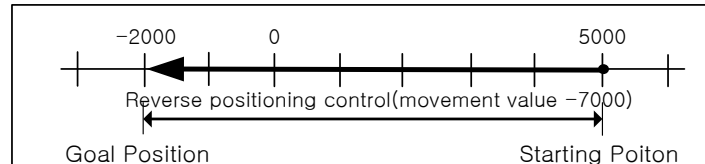

1.4.2 Interpolation Control

(1) Linear Interpolation Control

Execute linear interpolation control with designated axis at start position (Current position).

Combination of interpolation axis is unlimited and it is available to execute max. 4 axis linear interpolation control

(a) Linear interpolation by absolute coordinates

- 1) Execute linear interpolation from starting position to goal position designated by positioning data.
- 2) Positioning control is executed based on origin designated in homing.
- 3) Movement direction is designated by starting position & goal position of each axis.
 - Starting position < Goal position : Positioning operation with forward direction
 - Starting position > Goal position : Positioning operation with reverse direction

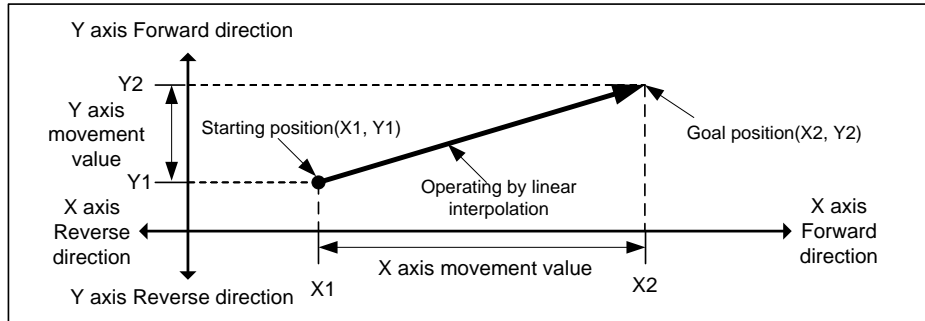

[Example]

- Starting Position (1000, 4000)
- Goal Position (10000, 1000)

In this condition, operation is as follows.

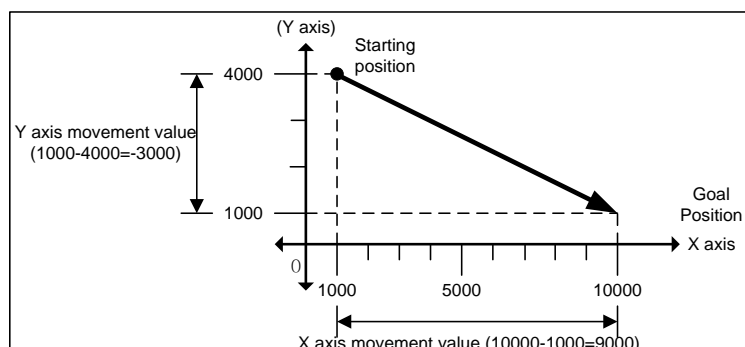

Chapter 1 Overview

(b) Linear Interpolation by incremental coordinates

- 1) Goal value becomes movement value
- 2) Moving direction depends on movement value is positive or negative.
 - Positive value (+ or 0) : Positioning operation with forward direction
 - Negative value (-) : Positioning operation with reverse direction

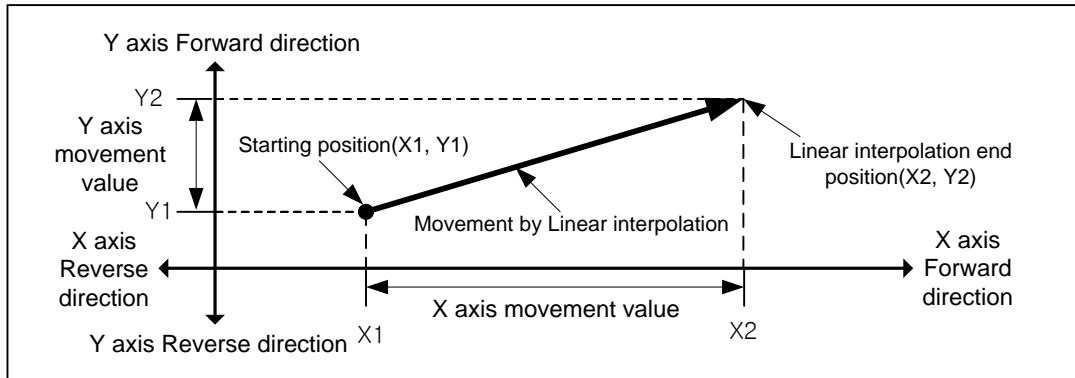

[Example]

- Starting position (1000, 4000)
- Goal position (9000, -3000)

In this condition, operation is as follows.

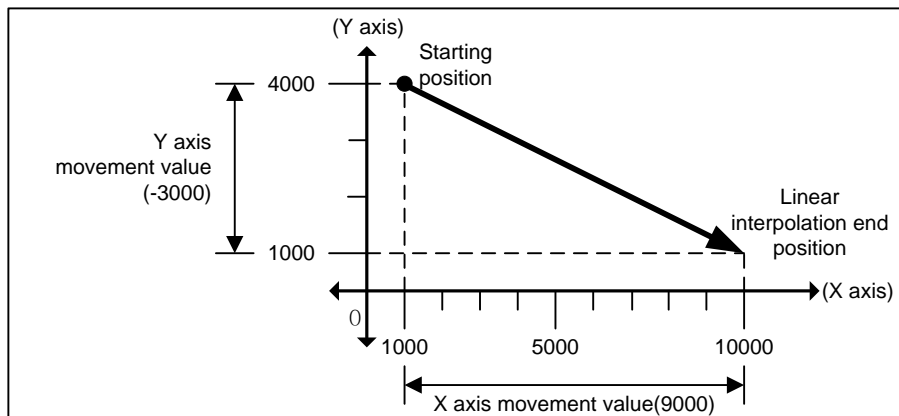

(2) Circular Interpolation Control

Execute interpolation operation along the trace of circle with 2 axes in direction that already designated for each axis. Circular interpolation has 3 types according to auxiliary point, Middle point method passing auxiliary point, Center point method using auxiliary point as center of circle and Radius method using auxiliary point as radius of circle. In addition, it is available to be executed more than 360° circular interpolation according to the value of 'circular interpolation turns'.

There is no limitation for the combination of 2 axes that used in circular interpolation. (Available to use any 2 of axis1~4)

(a) Circular interpolation with middle point designation form.

- 1) Starts operating at starting position and execute circular interpolation through the designated middle point.
- 2) There will be a circular arc whose center point is crossing point of perpendicular bisection between starting position and middle point or middle point and goal position.

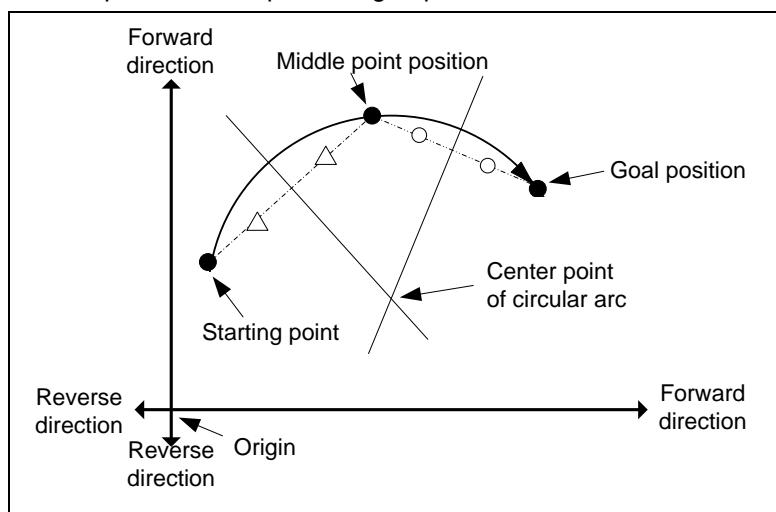

- 3) Control unit "degree" is not available to be used for circular interpolation control.
- 4) Movement direction is automatically designated by goal position and auxiliary point of circular interpolation

(b) Circular interpolation with center point designation form

- 1) Starts operating from starting position and execute circular interpolation along trace of circle that has distance from starting point to designated center point as radius.

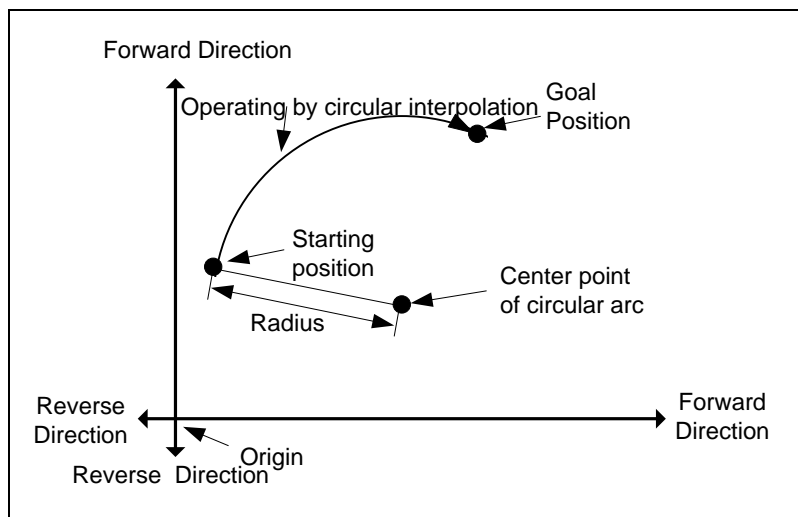

Chapter 1 Overview

- 2) If the goal position is same as starting position, it is available to have an operation like a circle that has distance from starting point to auxiliary point as its radius

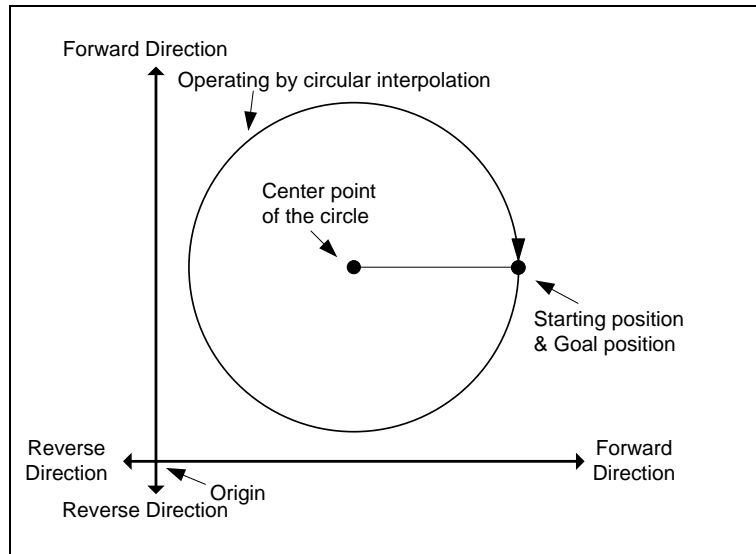

- 3) Control unit “degree” is not available to be used for circular interpolation control.
4) Direction is determined in setting of “Cir int. mode” (Center point CW, Center point CCW).

(c) Circular interpolation with radius designation form

- 1) Starts operating from starting position and execute circular interpolation along trace of circular arc that has value designated in auxiliary point of main axis as its radius. Depending on size setting of circular arc ($<180^\circ$, $\geq 180^\circ$), center point of circular arc will be different.

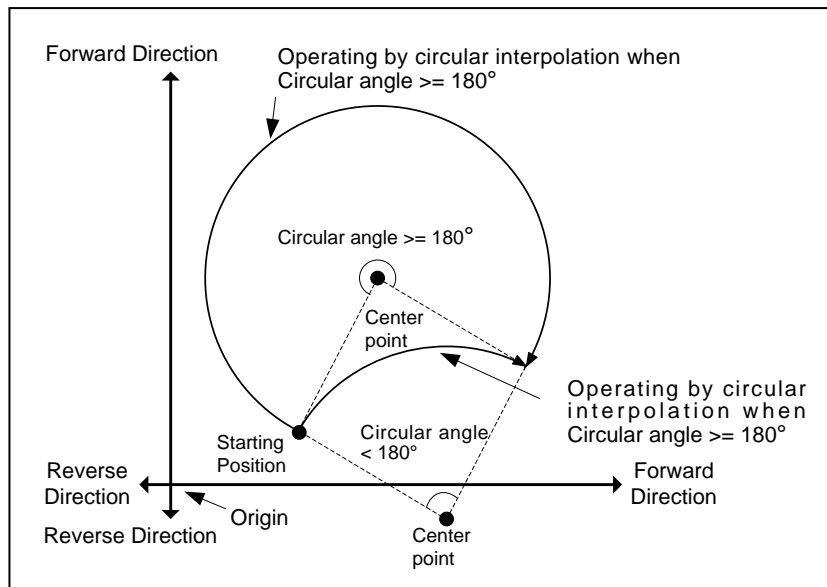

- 2) In radius designation form, goal position can't be set the same as starting position.
3) Control unit “degree” is not available to be used for circular interpolation control.
4) The direction and arc size are determined in “Cir. int. mode”.

(3) Helical Interpolation

- (1) Moves along the designated trace of circular arc depending on circular arc interpolation setting and executes linear interpolation synchronously.
- (2) It is available to execute helical interpolation of more than 360° depending on 'Circular interpolation turns' setting.
- (3) The combination of axis that used for helical interpolation control is unlimited, 3 axes among axis1 ~ 4 are used.

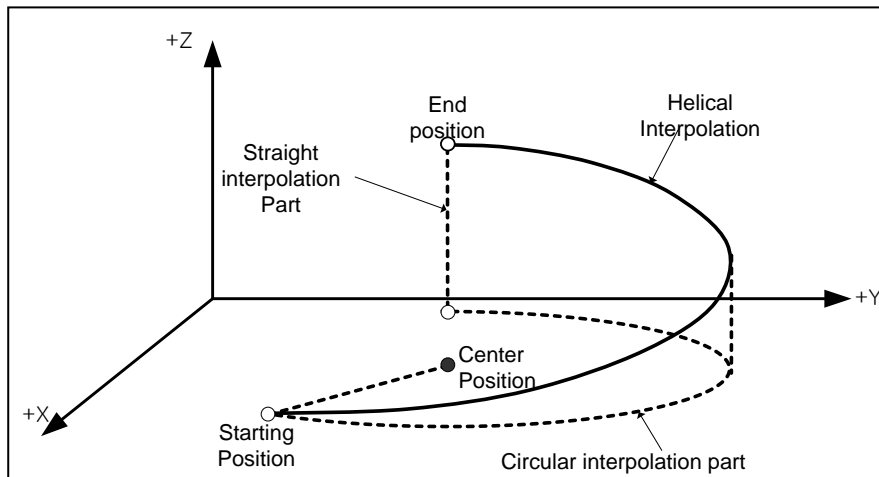

Chapter 1 Overview

1.4.3 Speed Control

- (1) It is executed by positioning operation start command (Direct start, Indirect start, Synchronous start) and keeps operating with designated speed until Dec. stop command.
- (2) Speed control has forward operation and reverse operation.
 - (a) Forward operation : Position value ≥ 0
 - (b) Reverse operation : Position value < 0
- (3) In case of speed control, M code will be on only when M code mode is "With".
- (4) Operating Timing

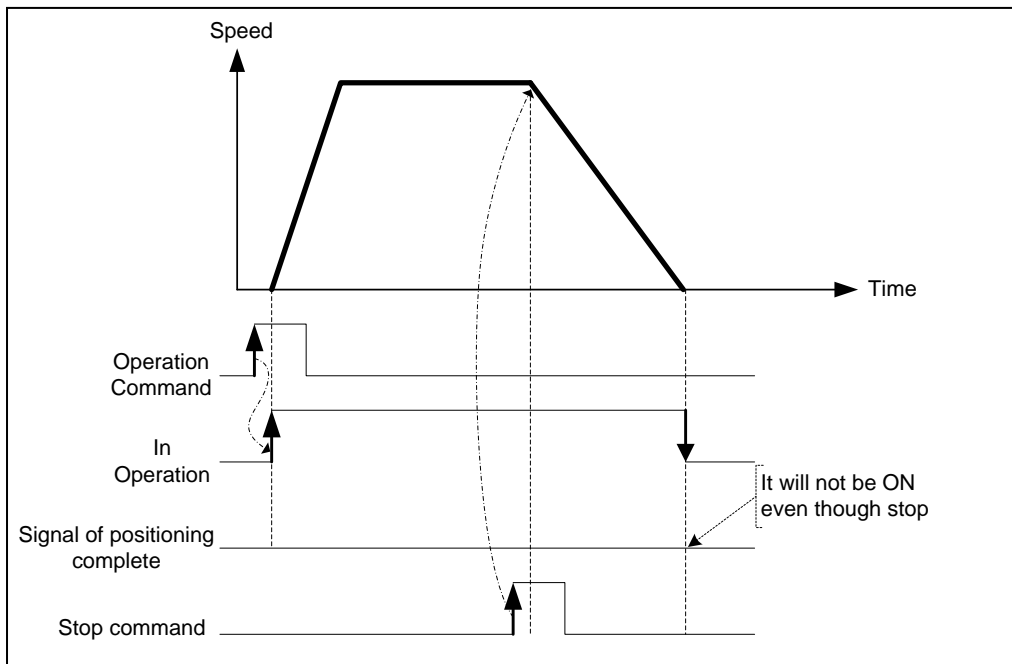

1.4.4 FEED Control

- (1) After executed by positioning start, reset the current position as 0 and start positioning as much as movement value already set.
- (2) Movement direction is decided by movement value.
- (3) Feed control has forward direction operation and reverse direction operation.
 - (a) Forward direction : Position value ≥ 0
 - (b) Reverse direction : Position value < 0
- (4) Operation timing is as follows.

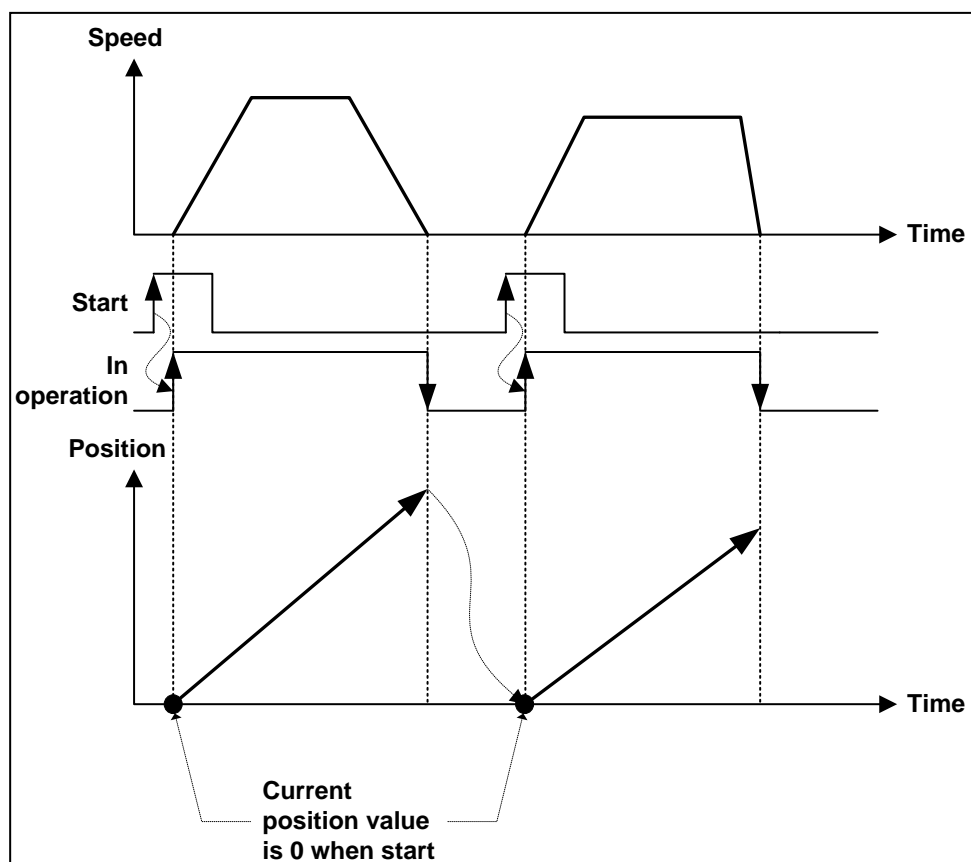

Chapter 2 Specifications

Chapter 2 Specifications

2.1 Performance Specifications

The following table shows the performance specifications of Embedded Positioning.

Model		XEC-DN32UP/(DC)/ XEC-DP32UP/(DC)/ XEC-DR28UP/(DC)			
Items					
No. of control axis		4			
Interpolation function		<ul style="list-style-type: none"> ▪2/3/4 axis linear interpolation ▪2 axis circular interpolation ▪3 axis helical interpolation 			
Control method		Position control, Speed control, Speed/Position control, Position/Speed control, Feed control			
Control unit		Pulse, mm, inch, degree			
Positioning data		Each axis can have up to 400 operation data .(Operation step number : 1 ~ 400) Available to set with software package(XG-PM) or program			
XG-PM	Connection	USB port of CPU			
	Setting data	Common, Basic, Extended, Manual operation, Homing, Input/output signal parameter, Operation data, Cam data, Command information			
	Monitor	Operation information, Trace, Input terminal information, Error information			
Back-up		Save the parameter, operation data in Flash ROM (No need of Battery, Max. 100,000 cycle)			
POSITIONING	Positioning method	Absolute method/Incremental method			
	Position address range		Absolute	Incremental	Speed/Position, Position/Speed Switching control
		mm	-214748364.8 ~ 214748364.7(μ m)	-214748364.8 ~ 214748364.7(μ m)	-214748364.8 ~ 214748364.7(μ m)
		Inch	-21474.83648 ~ 21474.83647	-21474.83648 ~ 21474.83647	-21474.83648 ~ 21474.83647
		degree	-21474.83648 ~ 21474.83647	-21474.83648 ~ 21474.83647	-21474.83648 ~ 21474.83647
		pulse	-2147483648 ~ 2147483647	-2147483648 ~ 2147483647	-2147483648 ~ 2147483647
	Speed range	mm	0.01 ~ 21474836.47 (mm/min)		
Inch		0.001 ~ 2147483.647 (Inch/ min)			
degree		0.001 ~ 2147483.647 (degree/min)			
pulse		1 ~ 2,000,000(pulse/sec): Line driver			
rpm		0.1 ~ 100000.0(RPM)			
Acc./Dec. process		Trapezoid type, S-Curve			
Acc./Dec. time		0 ~ 2,147,483,647ms selection is available from 4 types of acceleration/deceleration pattern			
Manual Operation		Jog Operation, MPG Operation, Inching Operation			
Homing method		DOG + HOME (Off), DOG + HOME(On), upper limit + HOME, DOG, High speed, Upper/Lower limit, HOME			
Speed change function		Speed change (Percent/Absolute value)			
External Encoder input	No. of Channel	1			
	Max. speed	200 kpps, (Low-Active)			
	Signal	Line drive input (RS-422A IEC specification)			
	Input type	W/CCW, PULSE/DIR, Phase A/B(4 mul.)			

Items \ Model	XBC-DN32UP/ XBC-DP32UP/ XBC-DR28UP
Control Period	1 ms, (5 ms when continuous operation is used)
Max. output speed	2 Mpps (PHASE : 2500kpps)
Max. connection distance	10m
Error indication	Indicated by LED
Connector	40 Pin connector * 2EA
Size of use cable	AWG #24
Current consumption	Max. 800mA
Weight	660g

Chapter 2 Specifications

2.2 External Interface I/O Specifications

Here describes the I/O interface for external equipment.

2.2.1 Input Specifications

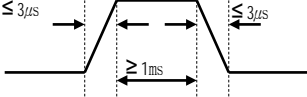
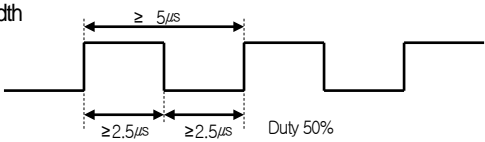
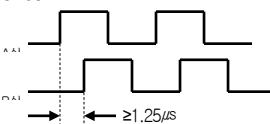
Signal name	Rated input voltage/current	Voltage range	On voltage/current	Off voltage/current	Input resistance	Response time
DOG	DC 24V/4.7mA	DC 20.4~26.4V	\geq DC 16V/3mA	\leq DC 4V/1mA	Approx. 5.15k Ω	\leq 1ms ¹
External high-limit	DC 24V/4.7mA	DC 20.4~26.4V	\geq DC 16V/3mA	\leq DC 4V/1mA	Approx. 5.15k Ω	\leq 1ms
External low-limit	DC 24V/4.7mA	DC 20.4~26.4V	\geq DC 16V/3mA	\leq DC 4V/1mA	Approx. 5.15k Ω	\leq 1ms
EMG stop/DEC stop	DC 24V/4.7mA	DC 20.4~26.4V	\geq DC 16V/3mA	\leq DC 4V/1mA	Approx. 5.15k Ω	\leq 1ms
Drive Ready	DC 24V/4.7mA	DC 20.4~26.4V	\geq DC 16V/3mA	\leq DC 4V/1mA	Approx. 5.15k Ω	\leq 1ms
Home	DC 5V/8.7mA	DC 4.25~5.5V	\geq DC 3V/3mA	\leq DC 1V/1mA	Approx. 1.73k Ω	\leq 0.2ms
						
Manual pulse generator / Encoder input	DC 5V/10mA	DC 4.25~5.5V	\geq DC 3V/5.0mA	\leq DC 1V/0.3mA	Approx. 300 Ω	1 μ s 0101
	Encoder input : based on RS-422A Line Driver Level (Am26LS31),(Active Low)					
	<p>1) Pulse width</p>  <p>2) Phase difference</p>  <p>If A phase input pulse precedes B phase input pulse, the position address value increases.</p> <p>If B phase input pulse precedes A phase input pulse, the position address value decreases.</p>					

¹ The response time is associated with the control period. response time can be up to 1ms when control period is 1ms and it can be up to 5ms when control period is 5ms The control period is 1ms when Continuous operation is disabled on the common parameters Enable. (5ms when Continuous operation is enabled)

2.2.2 Output Specifications

Signal	Rated load voltage	Available load voltage range	Max. load current / Inrush current	Max. voltage drop (On)	Leakage current (Off)	Response Time																															
Pulse Output	<ul style="list-style-type: none"> ▷ Differential Line Driver based on SN75ALS192 ▷ CW/ CCW type, PLS/DIR type, PHASE type can be selected from pulse output mode of basic parameter for program and XG-PM SW Package. ▷ Pulse output mode (settable in basic parameter of XG-PM or program) Pulse output level (settable in from common parameter of XG-PM or program) is as follows. 																																				
	<table border="1" style="width: 100%; border-collapse: collapse;"> <thead> <tr> <th rowspan="3">Pulse output mode</th> <th rowspan="3"></th> <th colspan="4">Output signal level</th> </tr> <tr> <th colspan="2">High Active</th> <th colspan="2">Low Active</th> </tr> <tr> <th>Forward</th> <th>Reverse</th> <th>Forward</th> <th>Reverse</th> </tr> </thead> <tbody> <tr> <td>CW/CCW</td> <td>CW CCW</td> <td></td> <td></td> <td></td> <td></td> </tr> <tr> <td>PLS/DIR</td> <td>PULSE Dir</td> <td></td> <td></td> <td></td> <td></td> </tr> <tr> <td>PHASE</td> <td>A B</td> <td></td> <td></td> <td></td> <td></td> </tr> </tbody> </table>						Pulse output mode		Output signal level				High Active		Low Active		Forward	Reverse	Forward	Reverse	CW/CCW	CW CCW					PLS/DIR	PULSE Dir					PHASE	A B			
Pulse output mode		Output signal level																																			
		High Active		Low Active																																	
		Forward	Reverse	Forward	Reverse																																
CW/CCW	CW CCW																																				
PLS/DIR	PULSE Dir																																				
PHASE	A B																																				
Servo On/ Servo Alarm Reset	DC 5~24V	DC 4.75~26.4V	0.1A(point) /0.4A ≤10ms	≤ DC 1V0 $\bar{0}$ (Rated) ≤ DC 2.5V0 $\bar{0}$ (Max.)	≤0.1mA	≤control period																															

Chapter 2 Specifications

2.2.3 External Equipment and Interface Specifications

(1) Pin Array of Connector

Pin Array	Pin no.				Signal Name	Signal direction PLC-Ext. Equipment	Trigger condition	
	AX4	AX3	AX2	AX1				
 <p>4 axis [모듈 정면]</p>	20A				MPG A+	Manual pulse generator/Encoder A+ input	←	
	20B				MPG A-	Manual pulse generator/Encoder A- input	←	
	19A				MPG B+	Manual pulse generator/Encoder B+ input	←	
	19B				MPG B-	Manual pulse generator/Encoder B- input	←	
	20C, 19C, 20D, 19D				NC	Not used		
	18D	18C	18B	18A	FP+	Forward Pulse output (Differential +)	→	
	17D	17C	17B	17A	FP-	Forward Pulse output (Differential -)	→	
	16D	16C	16B	16A	RP+	Reverse Pulse output (Differential +)	→	
	15D	15C	15B	15A	RP-	Reverse Pulse output (Differential -)	→	
	14D	14C	14B	14A	OV+	Upper Limit	←	
	13D	13C	13B	13A	OV-	Lower Limit	←	
	12D	12C	12B	12A	DOG	DOG	←	
	11D	11C	11B	11A	EMG	Emergency Stop	←	
					STOP	Dec. Stop Signal		
	10D	10C	10B	10A	COM1	Common (OV+, OV-, DOG, EMG/STOP)	↔	
	9D	9C	9B	9A	DR	Drive ready Signal	←	
	8D	8C	8B	8A	DR_COM	Drive ready Common	↔	
	7D	7C	7B	7A	SVON	Servo On output	→	
	6D	6C	6B	6A	AFMRST	Servo Alarm reset output	→	
	5D	5C	5B	5A	SVON/ RST_COM (COM2)	Servo On/Servo alarm reset COM	↔	
4D	4C	4B	4A	HOME +5V	Home Signal (+5V)	←		
3D	3C	3B	3A	HOME COM	Home Signal (+5V) Common	↔		
1~2A, 1~2B, 1~2C, 1~2D				NC	Not used			

(2) ACT 40P I/O Link connection

- Model: TG7-1H40S(Samwon ACT)
- Cable: C40HH-□PH-XBI

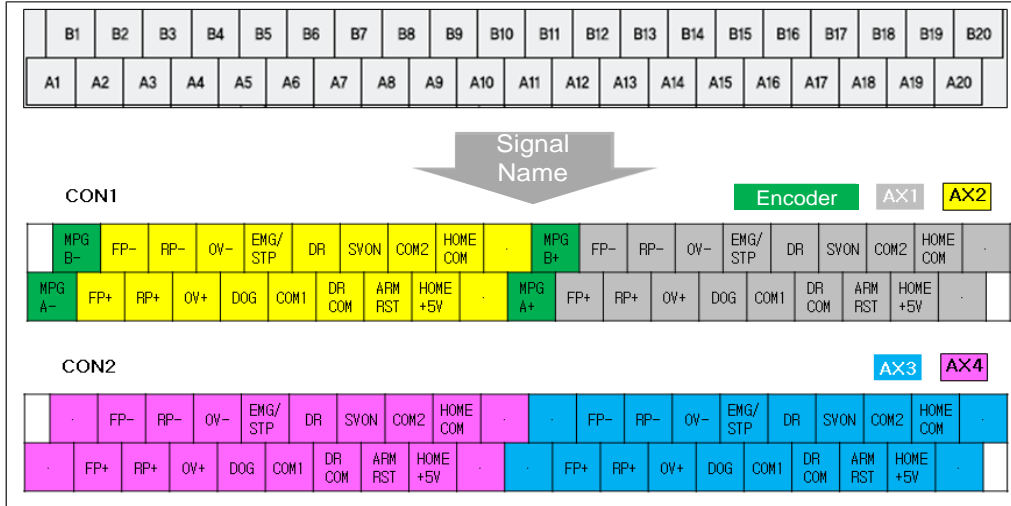

(3) Internal circuit of connector

(a) Pulse output

Internal circuit	Pin No.				Signal	
	AX4	AX3	AX2	AX1		
Line Driver output 	18D	18C	18B	18A	FP+	Pulse F+(CW/PLS/Phase A)
	17D	17C	17B	17A	FP-	Pulse F-(CW/PLS/Phase A)
	16D	16C	16B	16A	RP+	Pulse R+(CCW/DIR/Phase B)
	15D	15C	15B	15A	RP-	Pulse R-(CC/DIR/Phase B)

(b) Input signal

External Circuit	Pin No.				Internal circuit	Signal	
	AX4	AX3	AX2	AX1			
	14A	14B	14C	14D		OV+	Upper limit signal(B contact point)
	13A	13B	13C	13D		OV-	Lower limit signal(B contact point)
	12A	12B	12C	12D	DOG	DOG	
	11A	11B	11C	11D	EMG/STOP	Emergency Stop Signal / External Stop Signal	
	10A	10B	10C	10D	COM	Common (OV+,OV-,DOG,EMG,STOP)	
	9A	9B	9C	9D	DR	Drive ready signal	
	8A	8B	8C	8D	DR COM	Drive ready Signal Common	
	4A	4B	4C	4D	HOME +5V	Home signal (+5V)	
	3A	3B	3C	3D	HOME COM	HOME (+5V) Common	



*1: Available to use NPN or PNP type device

Chapter 2 Specifications

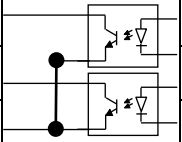
(c) External Output Signal(Open Collector Output)

Pin No.				Internal circuit	Signal	
AX4	AX3	AX2	AX1			
7A	7B	7C	7D		SVON	Servo On output
6A	6B	6C	6D		ARMRST	Servo Alarm Reset output
5A	5B	5C	5D		SVON/RST COM	Servo On output/ Alarm Reset Common

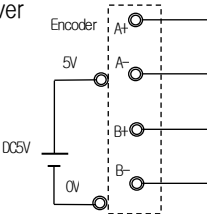
(d) Manual pulse generator input/encoder input (Low-Active)

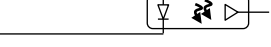
Classification	Pin No.	Internal circuit	Signal	
Line driver 	20A		MPG A+	Encoder A+ input
	20B		MPG A-	Encoder A- input
	19A		MPG B+	Encoder B+ input
	19B		MPG B-	Encoder B- input

2.3 The Name of Each Part

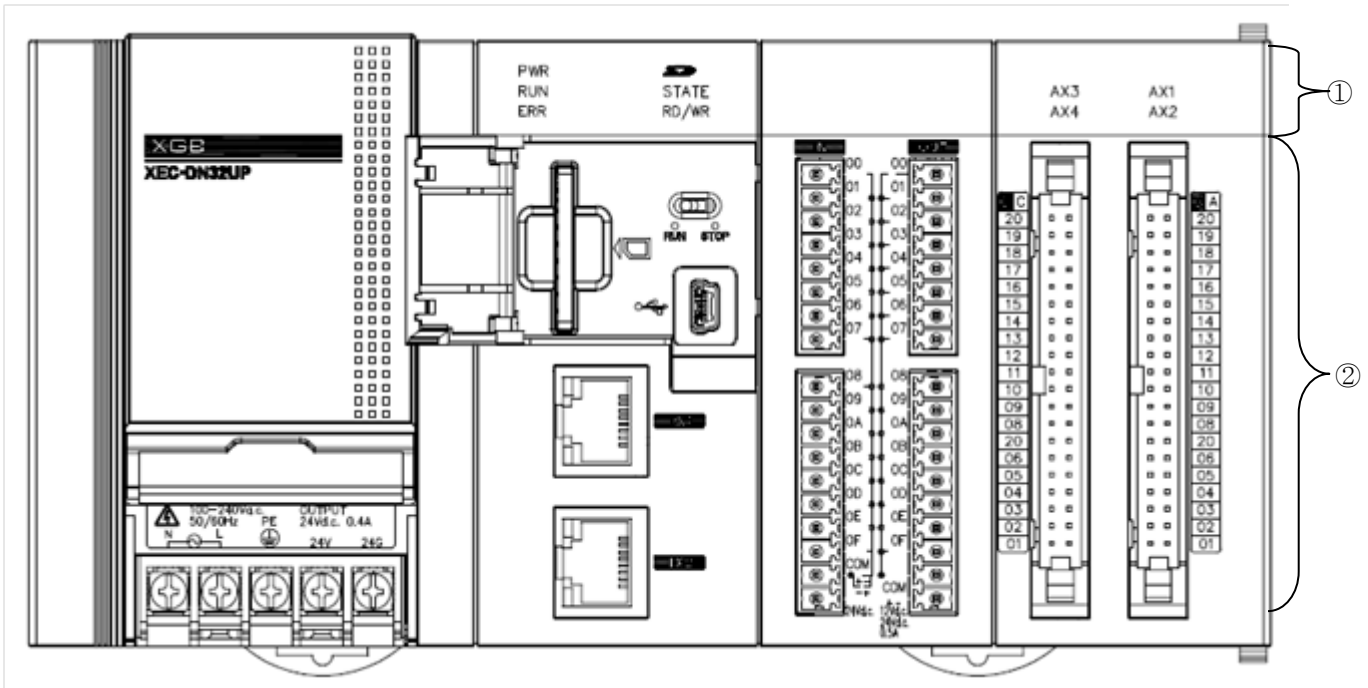

No.	Name	Description
①	Indication LED (AX1 ~ AX4)	1. Operating indication ▶ On : during operation of the corresponding axis ▶ Off : when the corresponding axis stops 2. Error indication ▶ On or Off : No Error ▶ Blinking : error of the corresponding axis (LED of axis having error would be blinking)
②	External connector	Connector for drive, input, encoder

Chapter 3 Operation Order and Installation

3.1 Operation Order

This chapter describes the Operation order in case of positioning operation by embedded positioning.

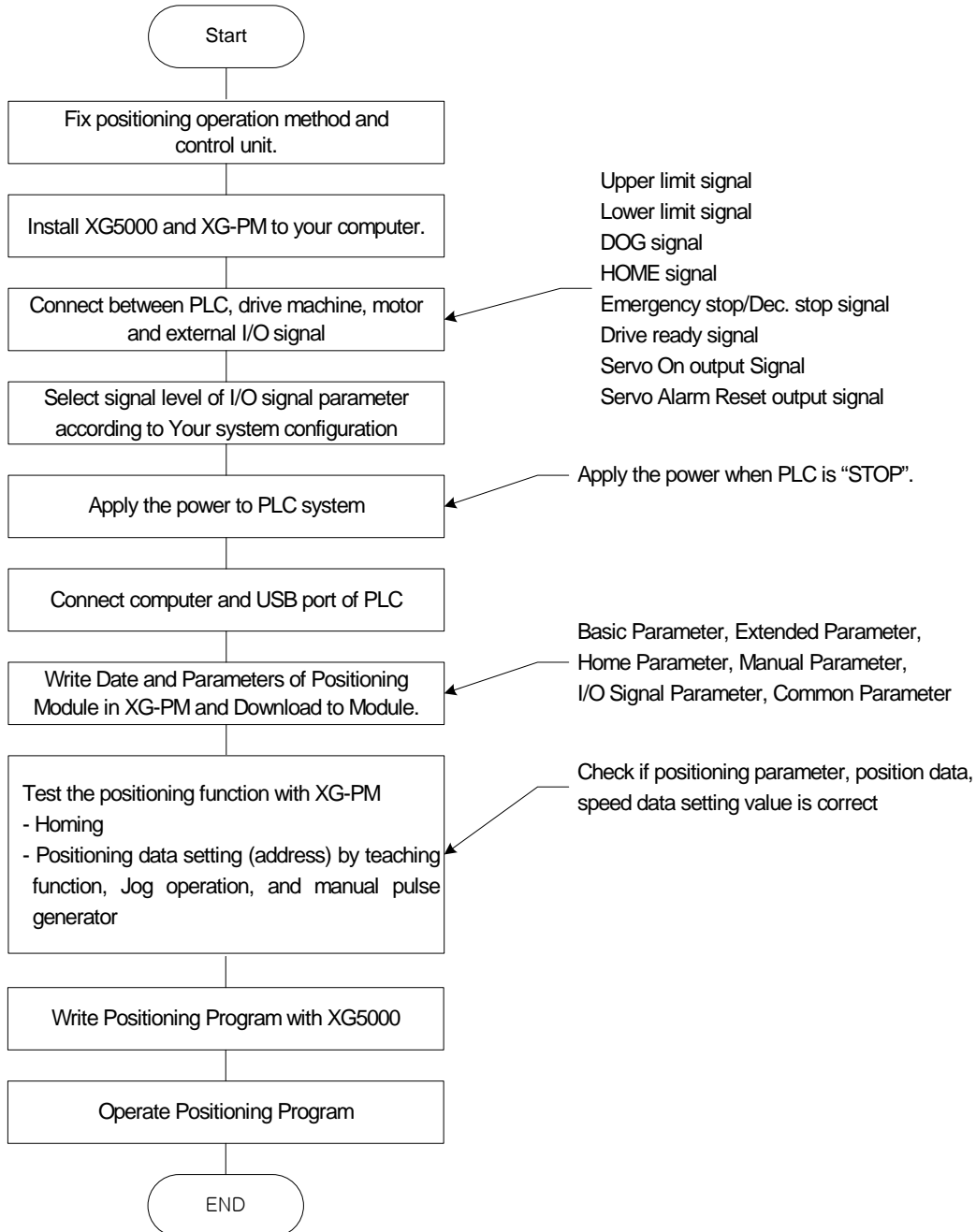

3.2 Installation

3.2.1 Installation Environment

This machine has a good reliability regardless of installation environment but cares should be taken in the following items to guarantee the reliability and safety of the system.

(1) Environment Condition

- Install the control panel available for water-proof, anti-vibration.
- The place free from continuous impact or vibration.
- The place not exposed to direct rays.
- The place with no dew phenomena by rapid temperature change.
- The place where surrounding temperature maintains 0-55°C.

(2) Installation Construction

- In case of processing the screw hole or wiring, cares should be taken not to put the wiring remnants to PLC inside.
- Install on the good place to operate.
- Do not install the high voltage machine on the same Panel.
- The distance from duct or surrounding module shall be more than 50mm.
- Ground to the place where surrounding noise environment is good enough.

3.2.2 Notices in Handling

Here describes the notices in handling the positioning module from opening to installation.

- (1) Do not fall down or apply the strong impact.
- (2) Do not remove PCB from the case. It may cause the failure.
- (3) In wiring, cares should be taken not to put the wiring remnants or foreign materials to the upper part of module. If something entered, it should be removed.
- (4) The removal of module in the status of power ON is prohibited.
- (5) When using the system of positioning control, please use it after you've set up the origin.
When Power On or Off, change of pulse output could occurred by Power On or Off.

3.3 Notices in Wiring

3.3.1 Notices in Wiring

- 1) The length of connecting cable between positioning module and drive machine shall be as short as possible (Max. 10m).
- 2) For alternating current and external I/O signal of positioning module, it is required to use the separate cables to avoid the surge or induction noise generated from the alternating current.
- 3) The wires should be selected considering surrounding temperature, allowable current and it is recommended to be more than max. size AWG22 (0.3mm²).
- 4) In wiring, if it is too close to the high temperature machine or material or it is directly contacted to the oil for a long time, the short-circuit will occur that may cause the damage or malfunction.
- 5) Make sure to check the polarity before applying the external contact signal to the terminal board.
- 6) In case of wiring the high voltage cable and power cables together, the induction noise occurs that may cause the malfunction or failure.
- 7) In case of wiring by the pipe, the grounding of pipe is required.
- 8) For the power supplied from outside (DC 5V, DC24V), it is required to use the safe and stable power.
- 9) In case that there may be the noise source in wiring between positioning module and drive machine, it is required to use and connect Twist pair and shielded cable for the wiring of output pulse that comes from the positioning and enters into the motor drive.

3.3.2 Connection Example of Servo and Stepping Motor Drive Machine

Notes

- ▶ Connection example is applied when the input signal parameter of PLC is set as follows
 Upper limit signal, lower limit signal, Emergency/Dec. stop signal : B contact,
 DOG signal, Home signal, Servo On output signal, Servo Alarm Reset output signal : A contact,

(1) MITSUBISHI

(a) MR-H□A Connection (Line Driver)

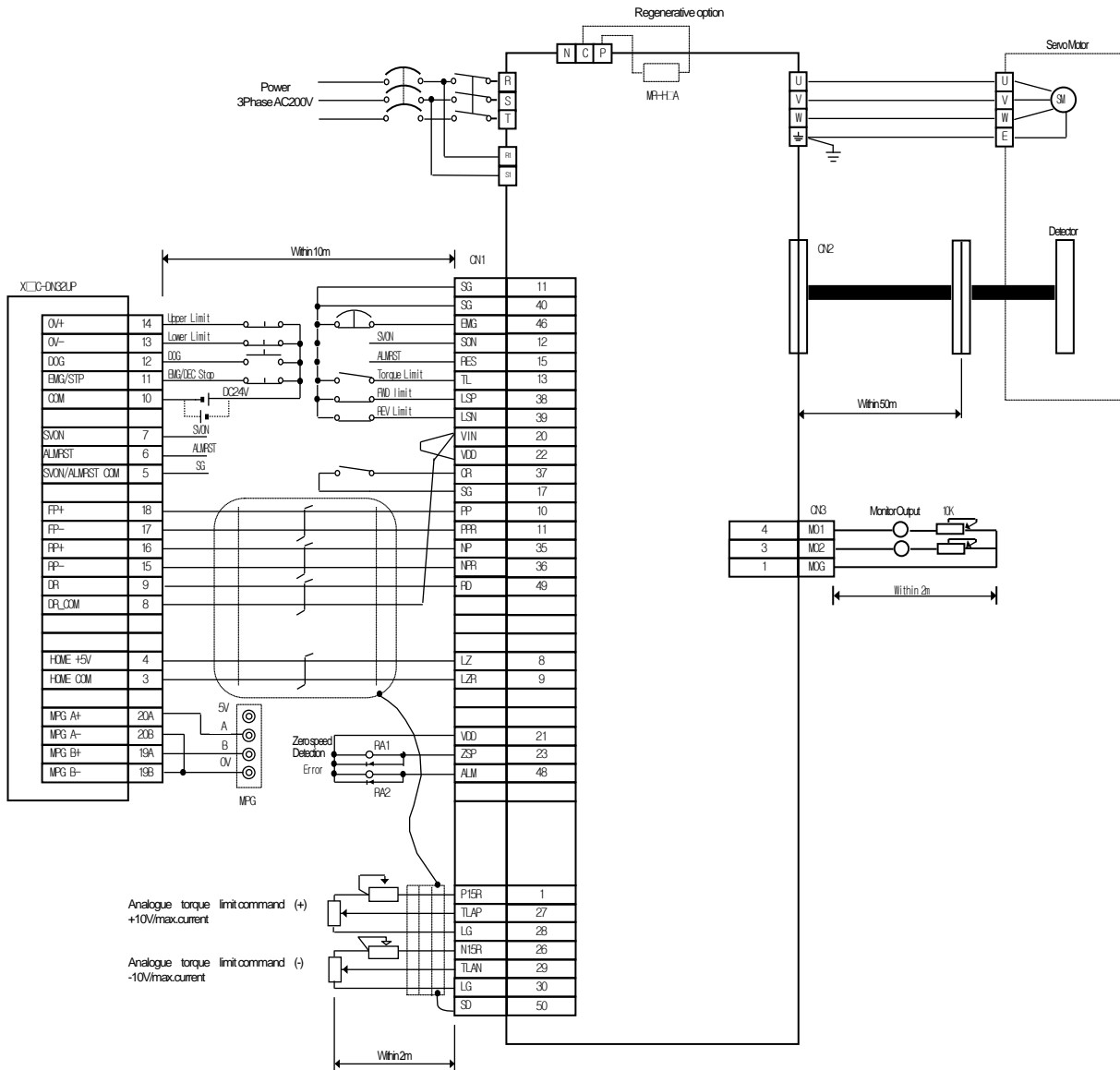

Chapter 3 Operation Order and Installation

(b) MR-J2/J2S-□A Connection

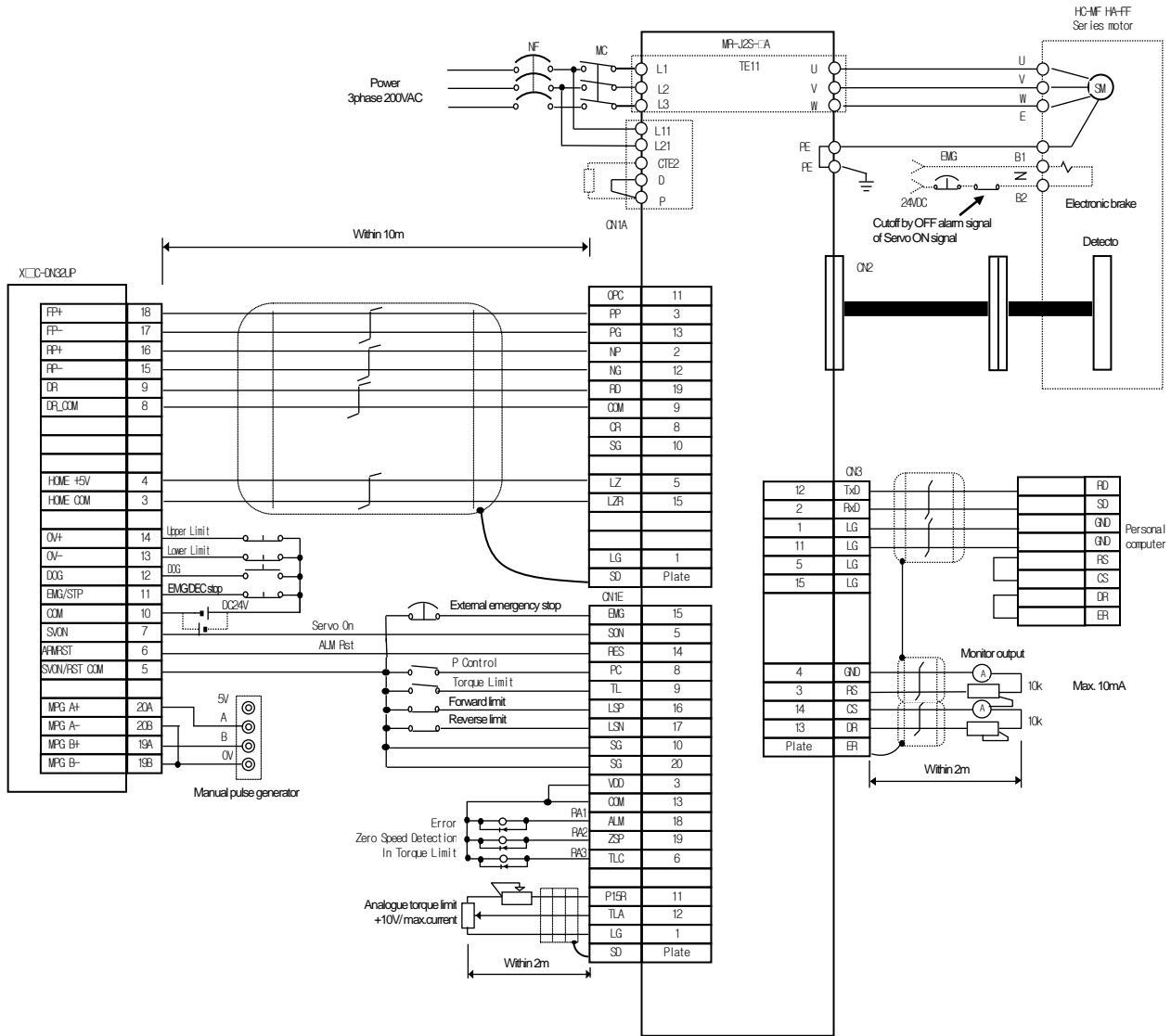

Chapter 3 Operation Order and Installation

(c) MR-J3-□A Connection

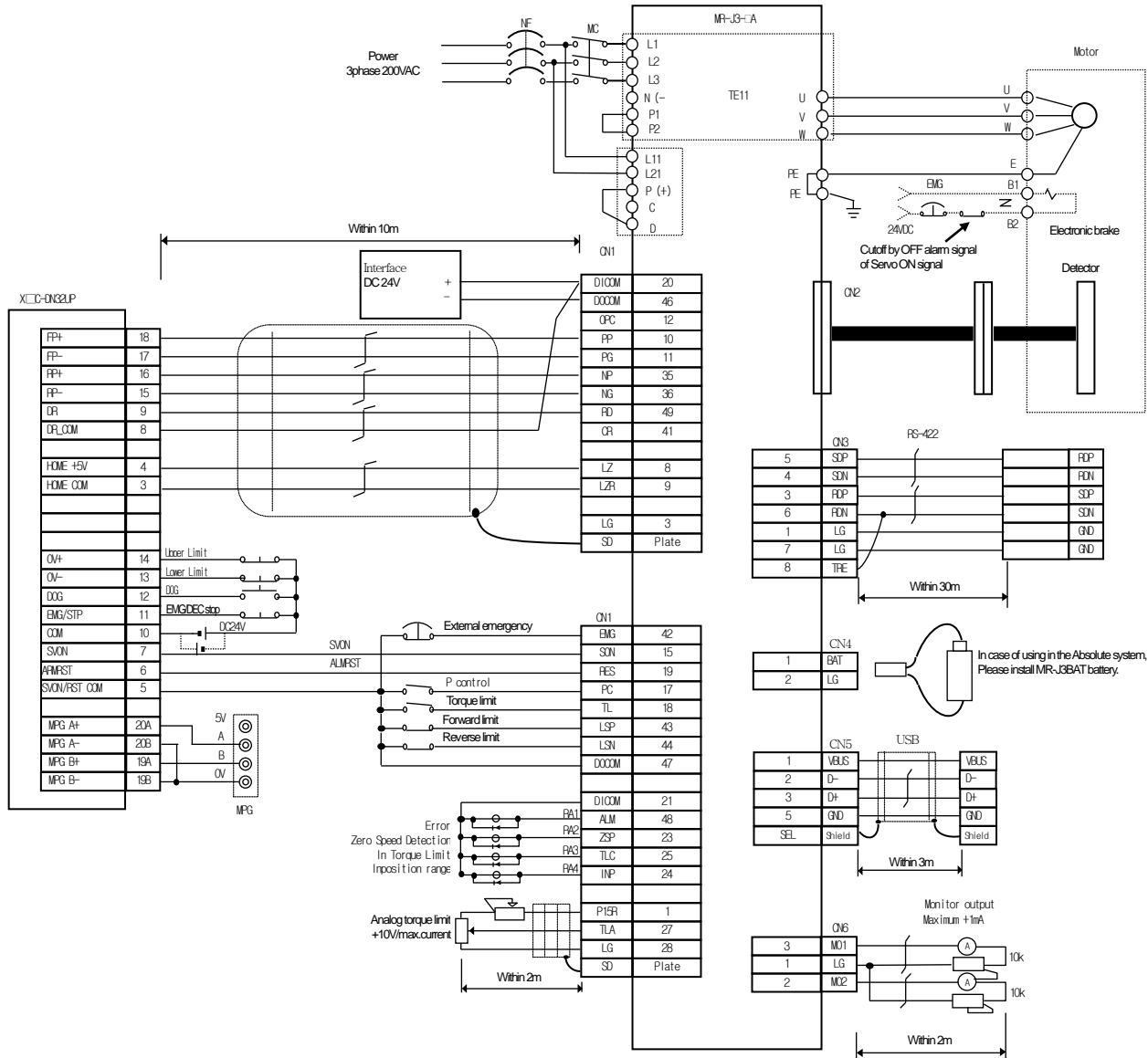

Chapter 3 Operation Order and Installation

(d) MR-J□A Connection (Line Driver)

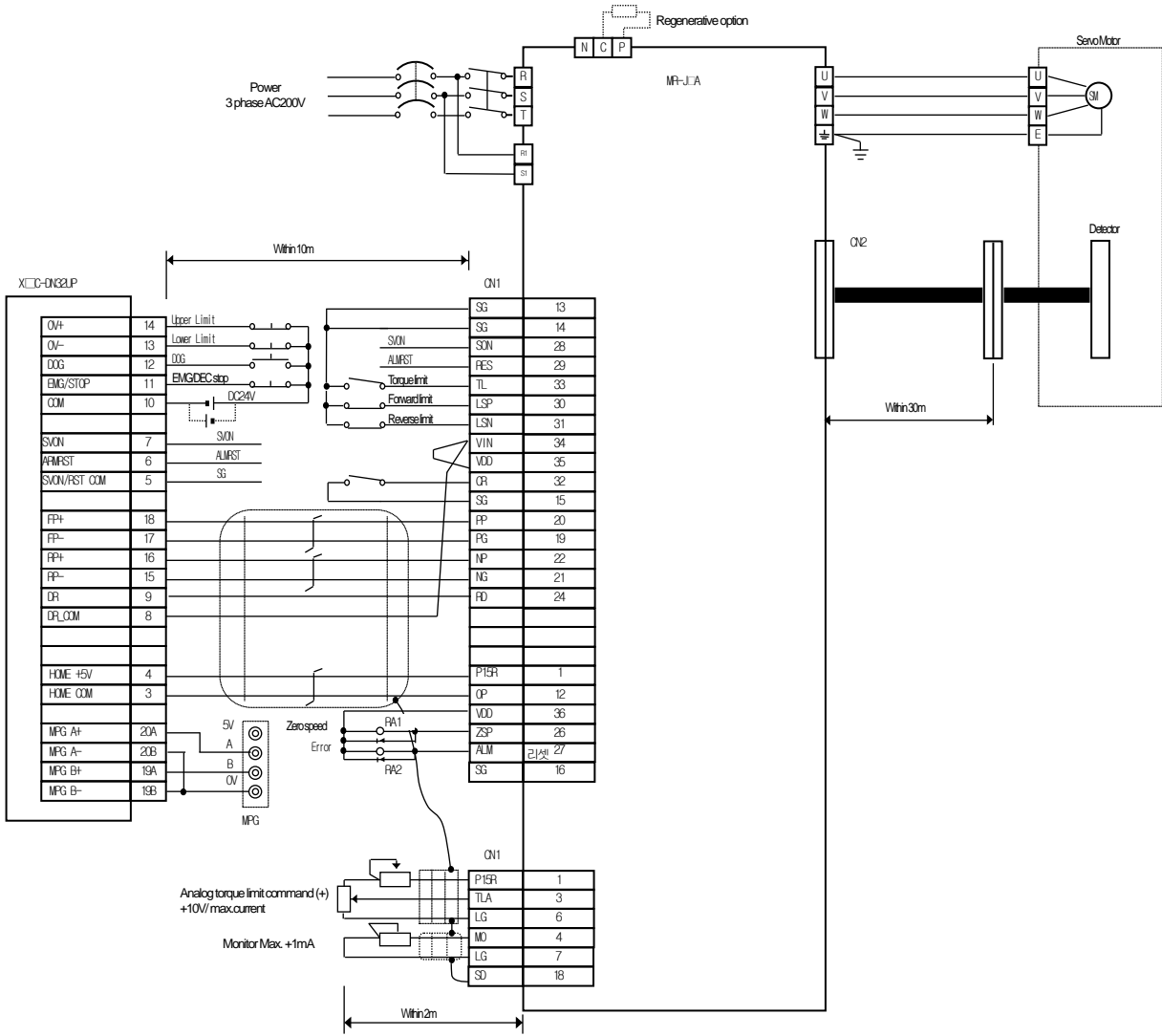

Chapter 3 Operation Order and Installation

(e) MR-C□A Connection (Line Driver)

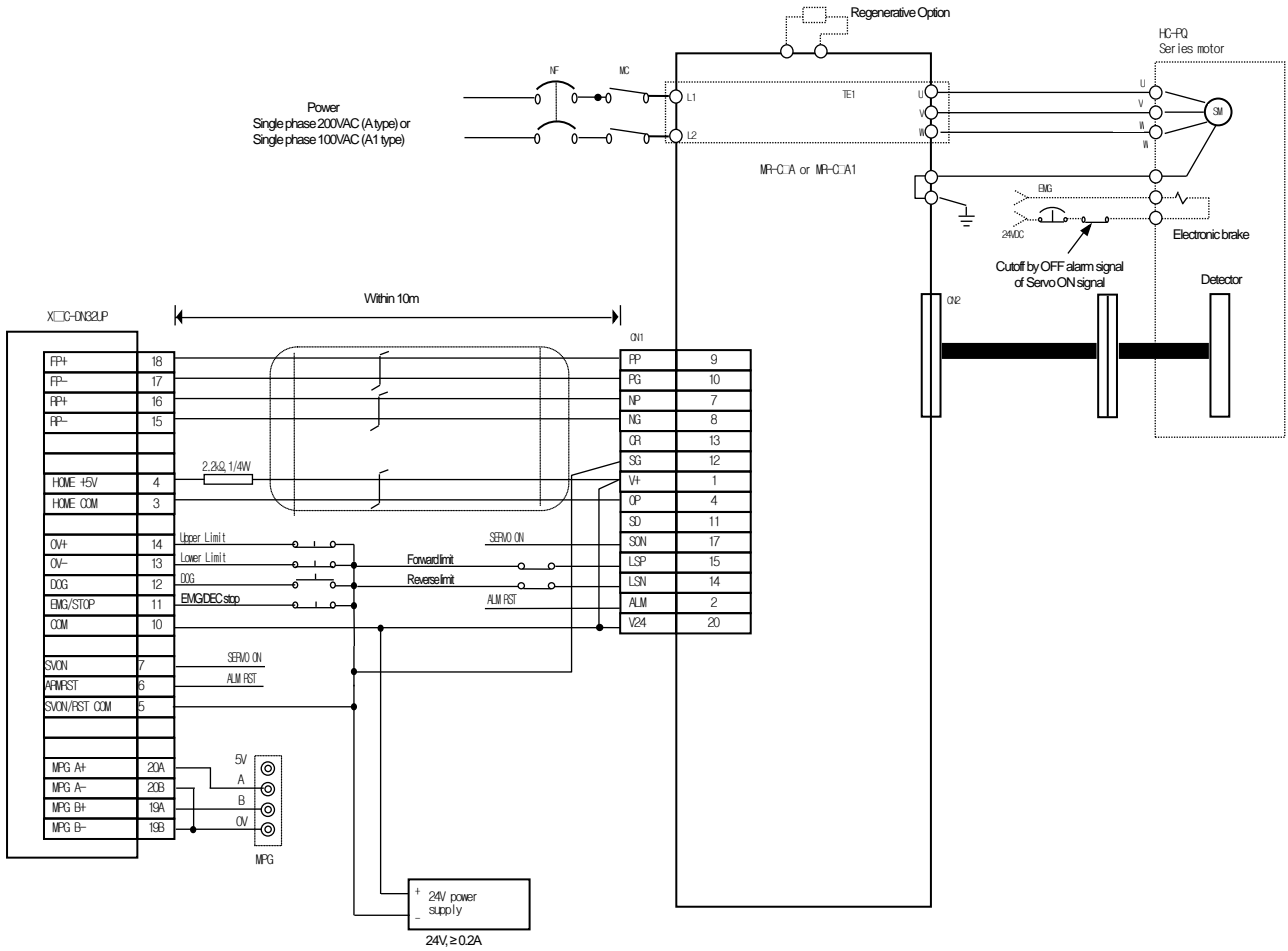

Chapter 3 Operation Order and Installation

(2) PANASONIC

(a) A Series Connection (Line Driver)

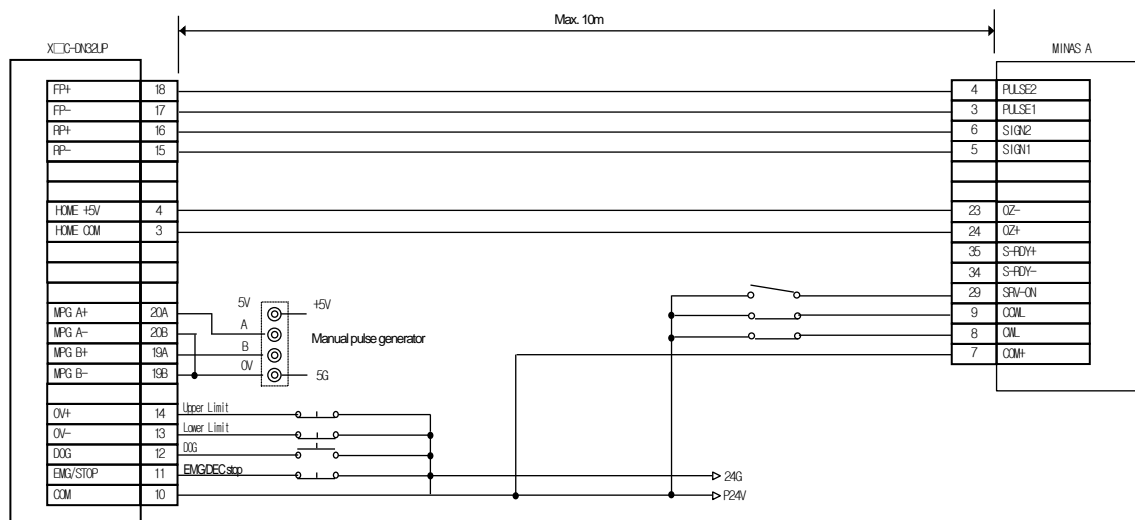

(3) VEXTA
 (a) UDX2107 Connection

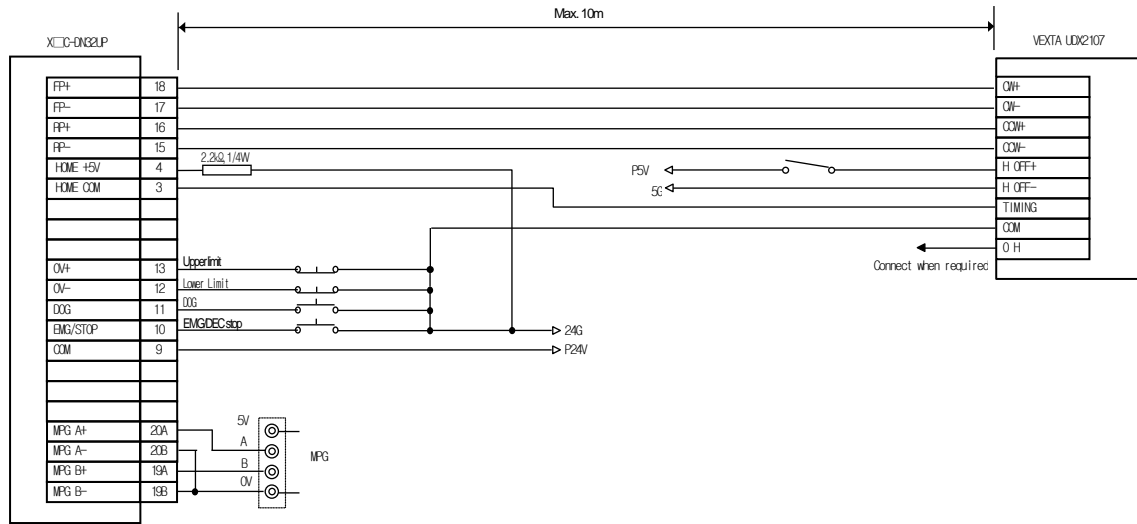

Chapter 3 Operation Order and Installation

(b) UPD Connection

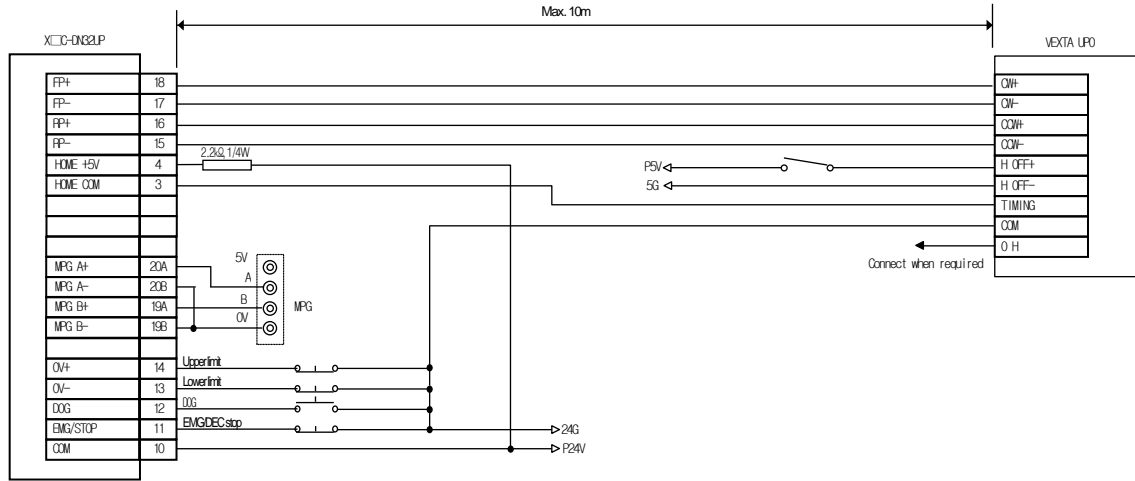

Chapter 3 Operation Order and Installation

(c) FX Connection

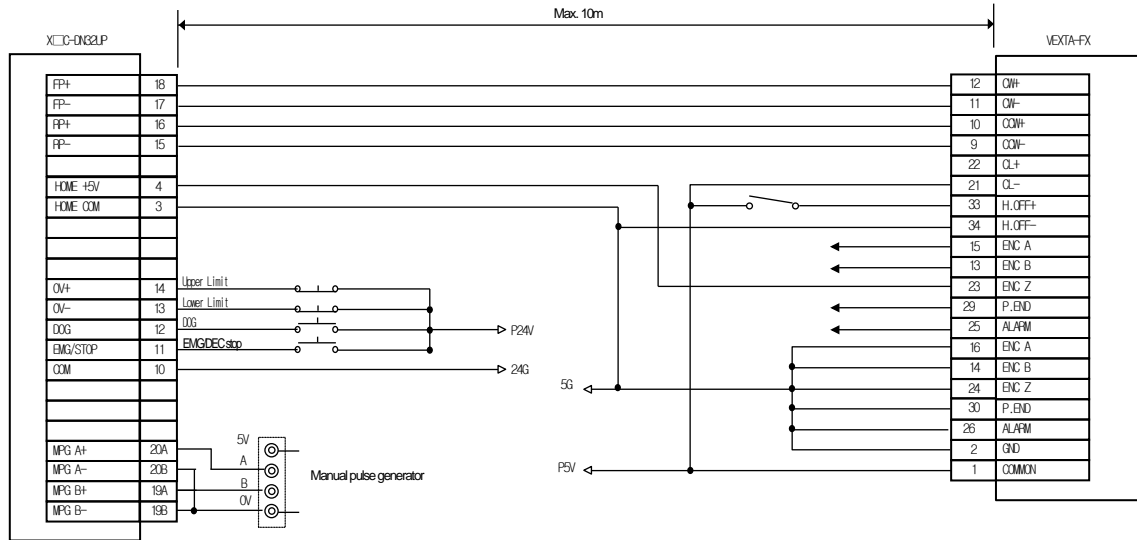

Chapter 3 Operation Order and Installation

(4) Higen Motor

(a) FDA-5000/6000/7000 AC Servo Drive Connection

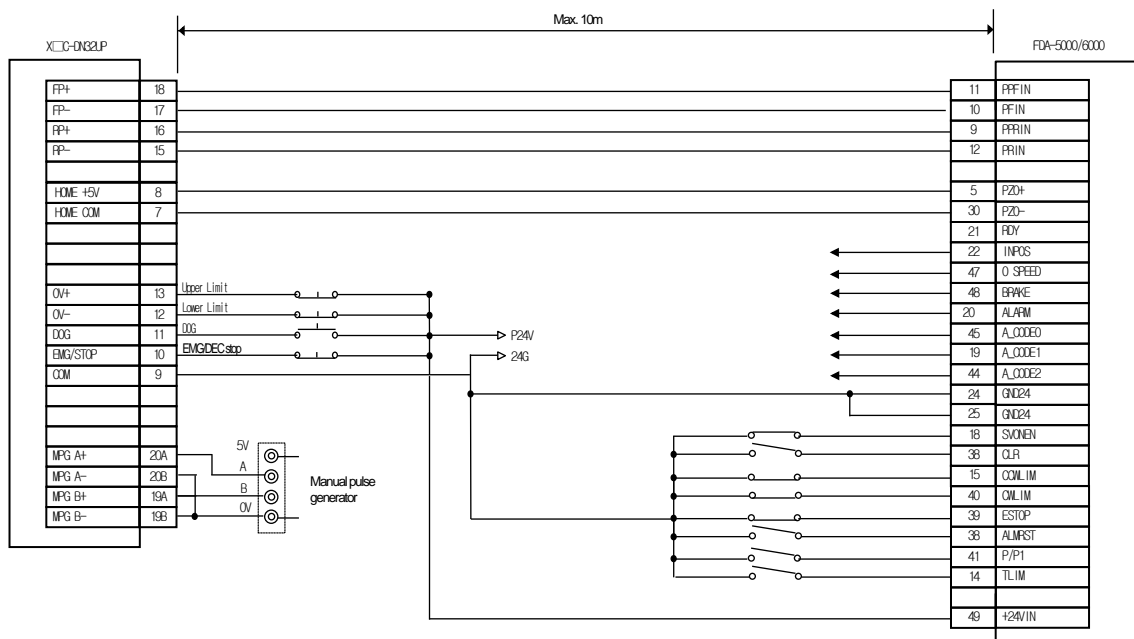

Chapter 3 Operation Order and Installation

(5) YASKAWA

(a) CACR (R Series) Connection (Line Driver)

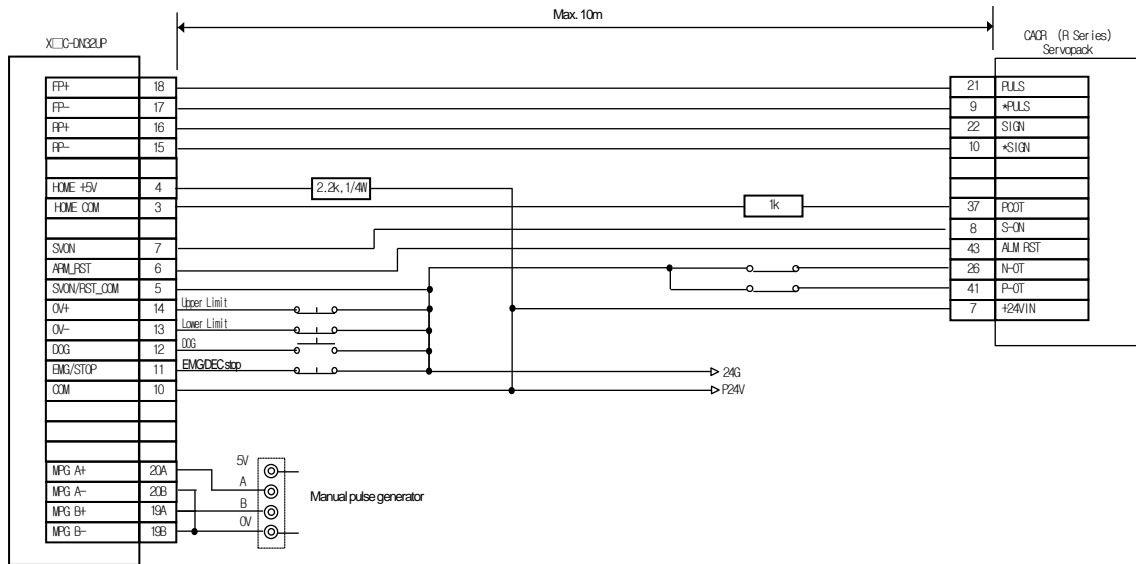

Chapter 3 Operation Order and Installation

(b) SGDA-□□□P Connection

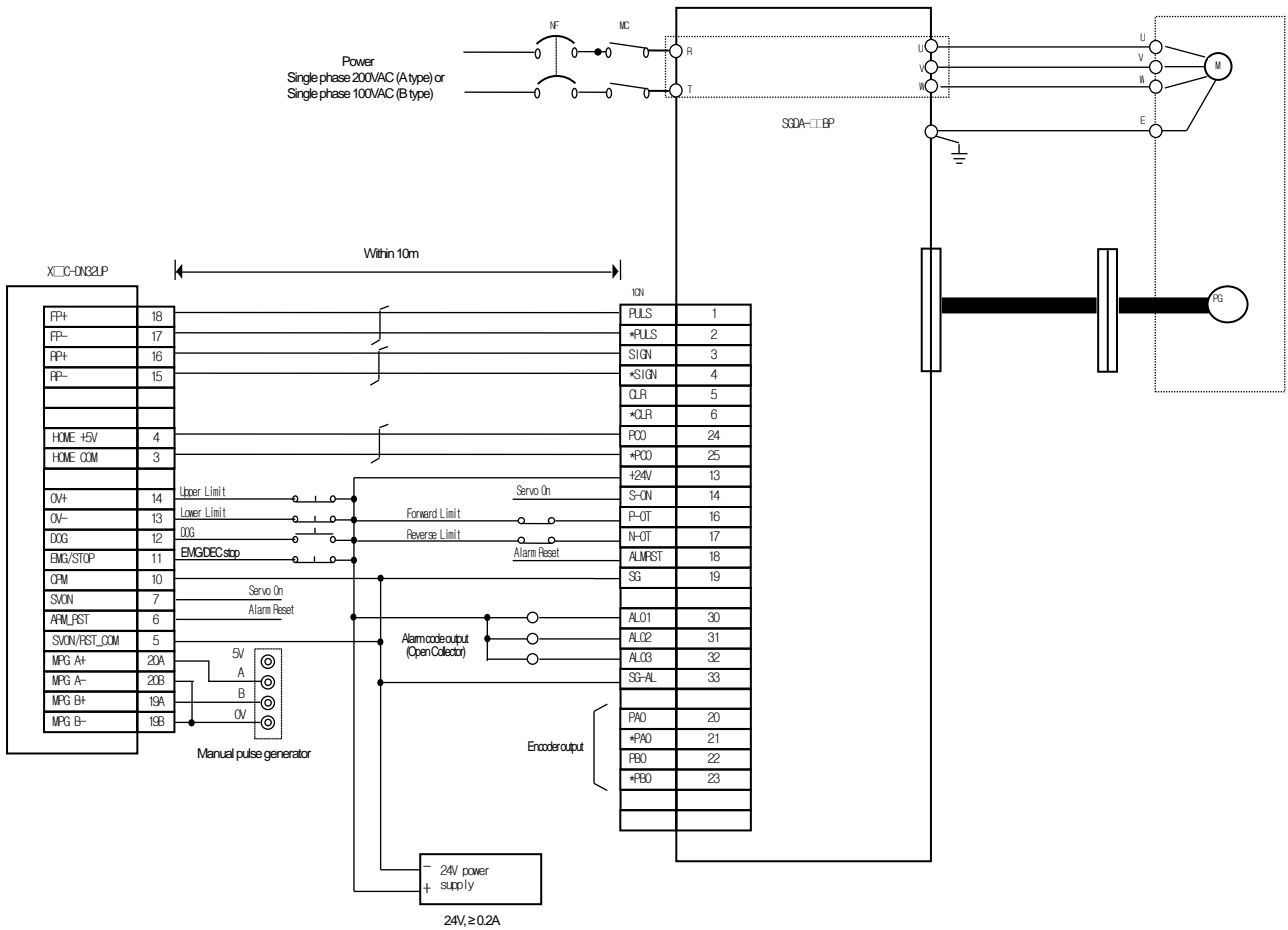

Chapter 3 Operation Order and Installation

(c) Σ -II Series SGDH AC Servo Drive Connection

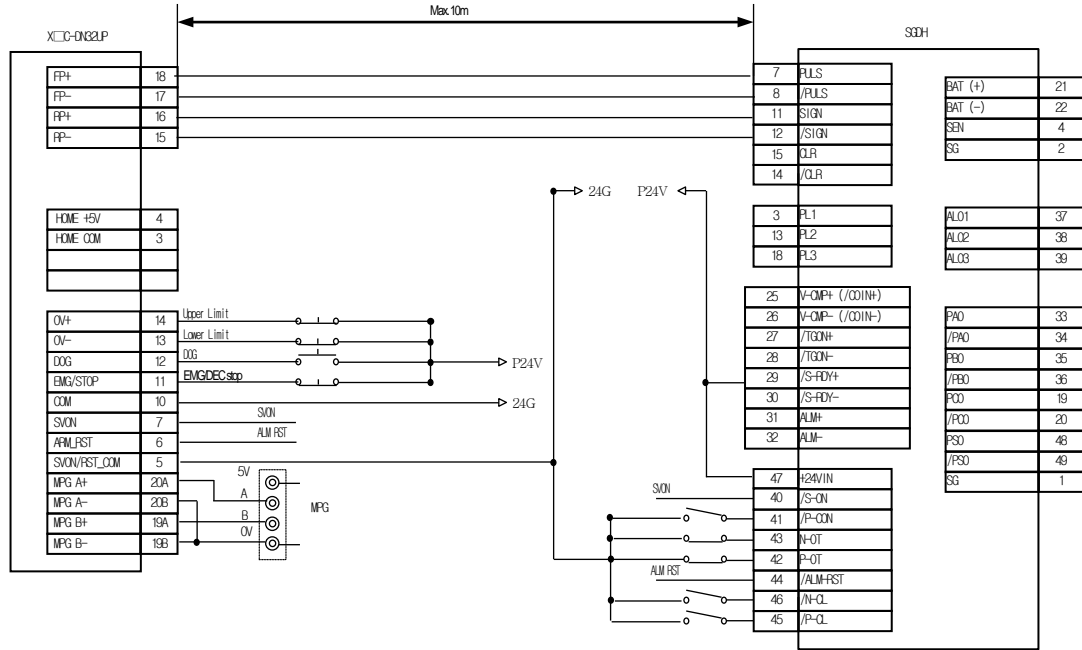

Chapter 3 Operation Order and Installation

(d) Σ -III Series SGDS AC Servo Drive Connection (Line Driver)

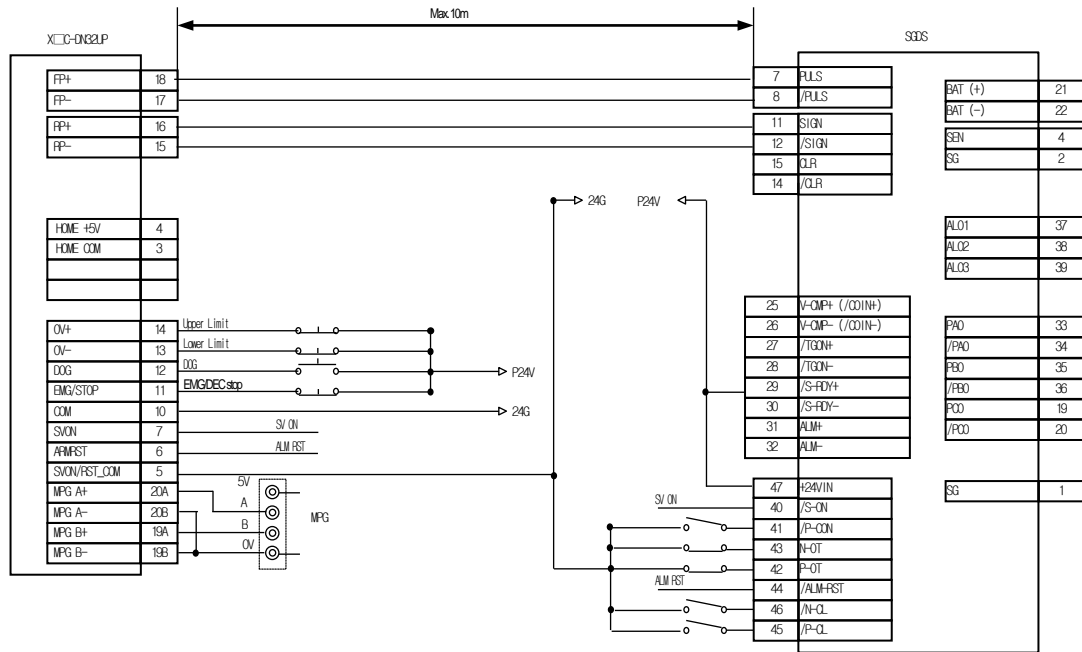

Chapter 3 Operation Order and Installation

(6) LS Mecapion (L7)

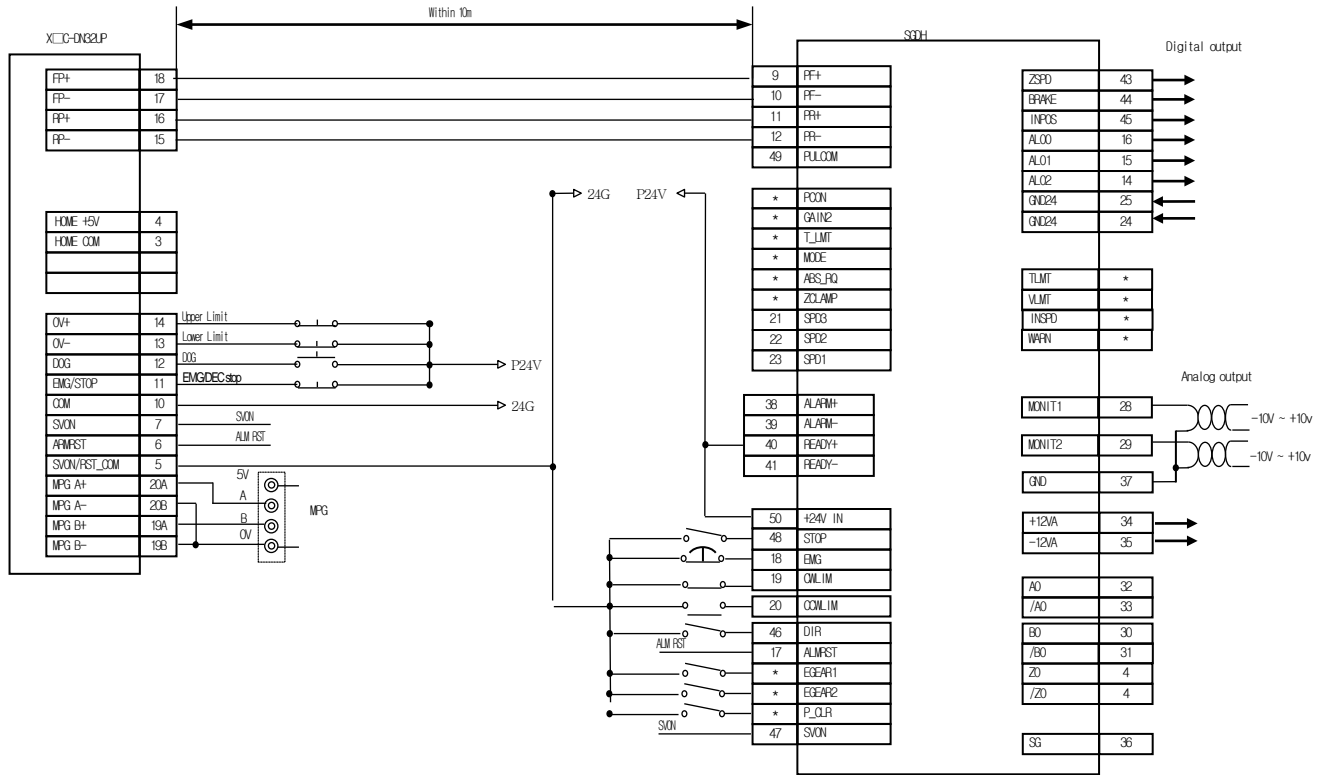

Note 1) Input signals DI1 to DIA and output signals DO1 to DO5 are default signals allocated by the factory.

Note 2) * These are non-allocated signals. You can change their allocation by setting parameters. For more information, refer to L7 series servo manual

Chapter 3 Operation Order and Installation

3.3.3 Encoder Input (DC 5V Voltage Output) Wiring Example

When Pulse Generator is a Voltage Output type, wiring example of positioning module is as follows

In case that pulse generator is totem-pole output which is used as voltage output, wiring method is same with above.

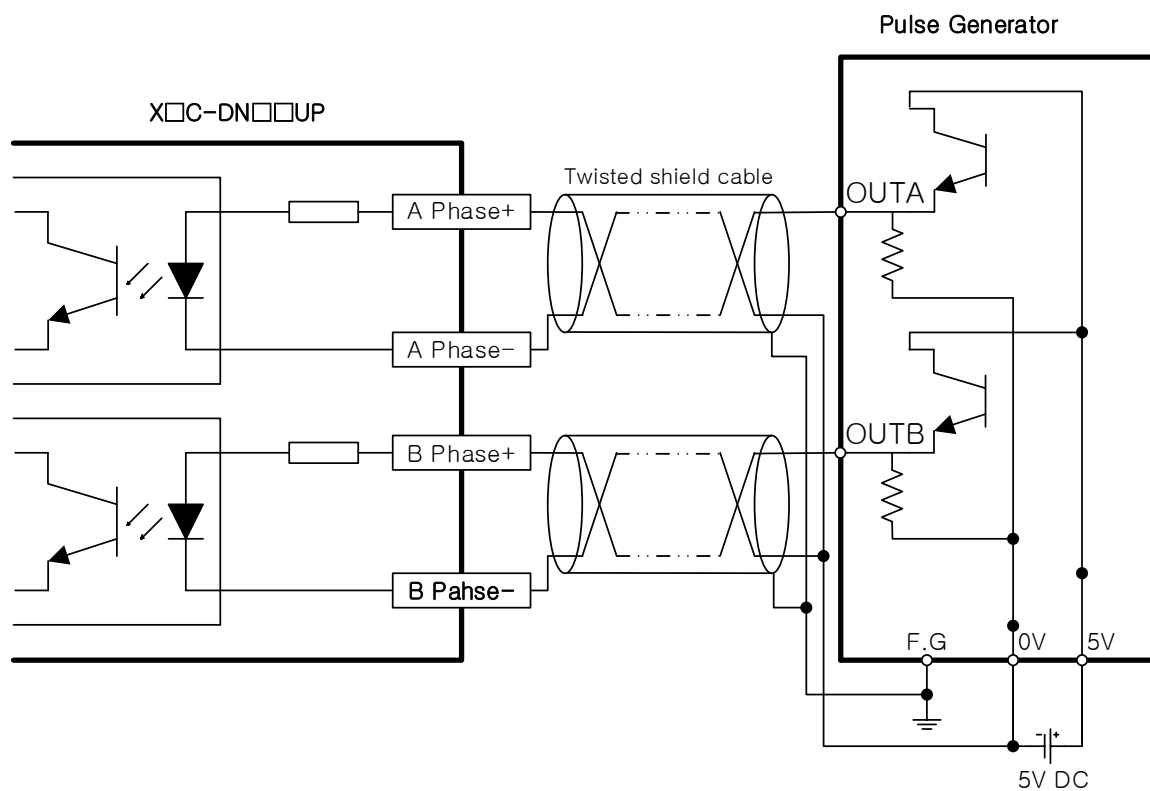

Notes

Before Wiring, please consider maximum output distance of pulse generator.

3.3.4 Encoder Input (5V Line Driver Output) Wiring Example

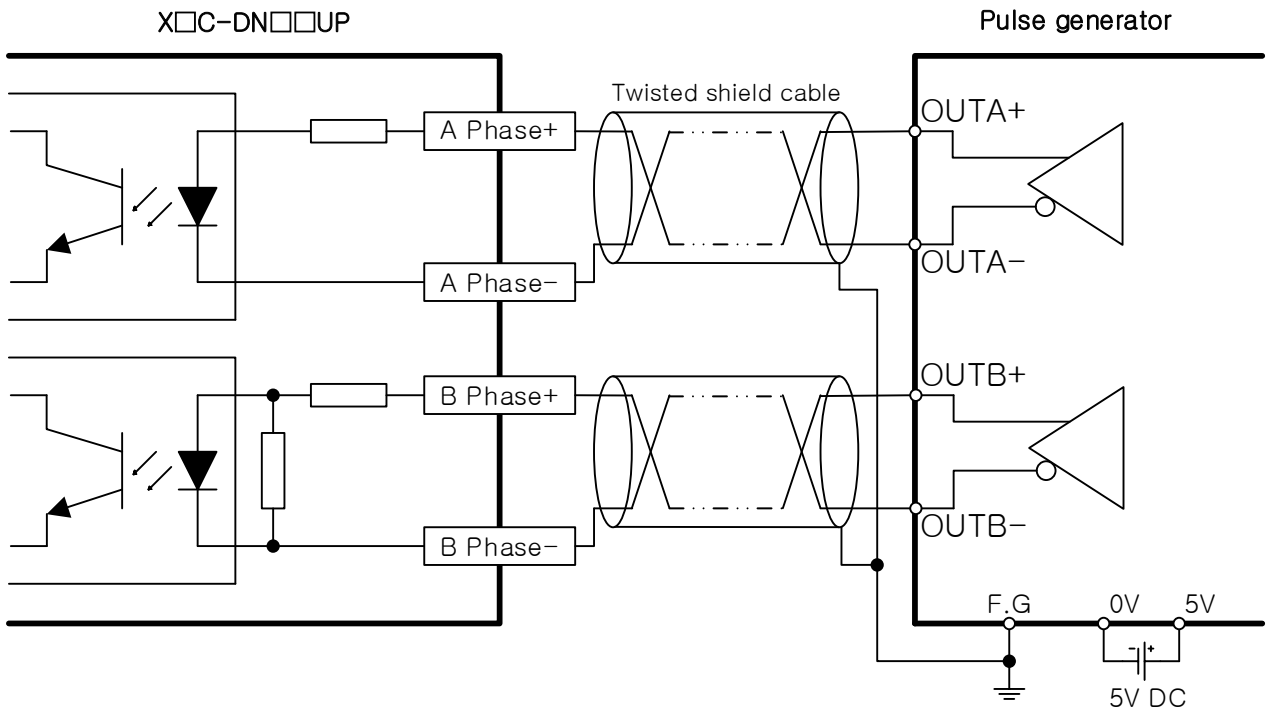
**Notes**

Before Wiring, please consider maximum output distance of pulse generator.

Chapter 4 Positioning Parameter & Operation Data

This chapter describes parameter and operation data to be set by software package with embedded positioning. Item of Parameter and operation data should be set for each axis(But common parameter shall be applied to all axis)

4.1 Parameter & Operation data

This picture describe process of parameter and operation data saved in the PLC.

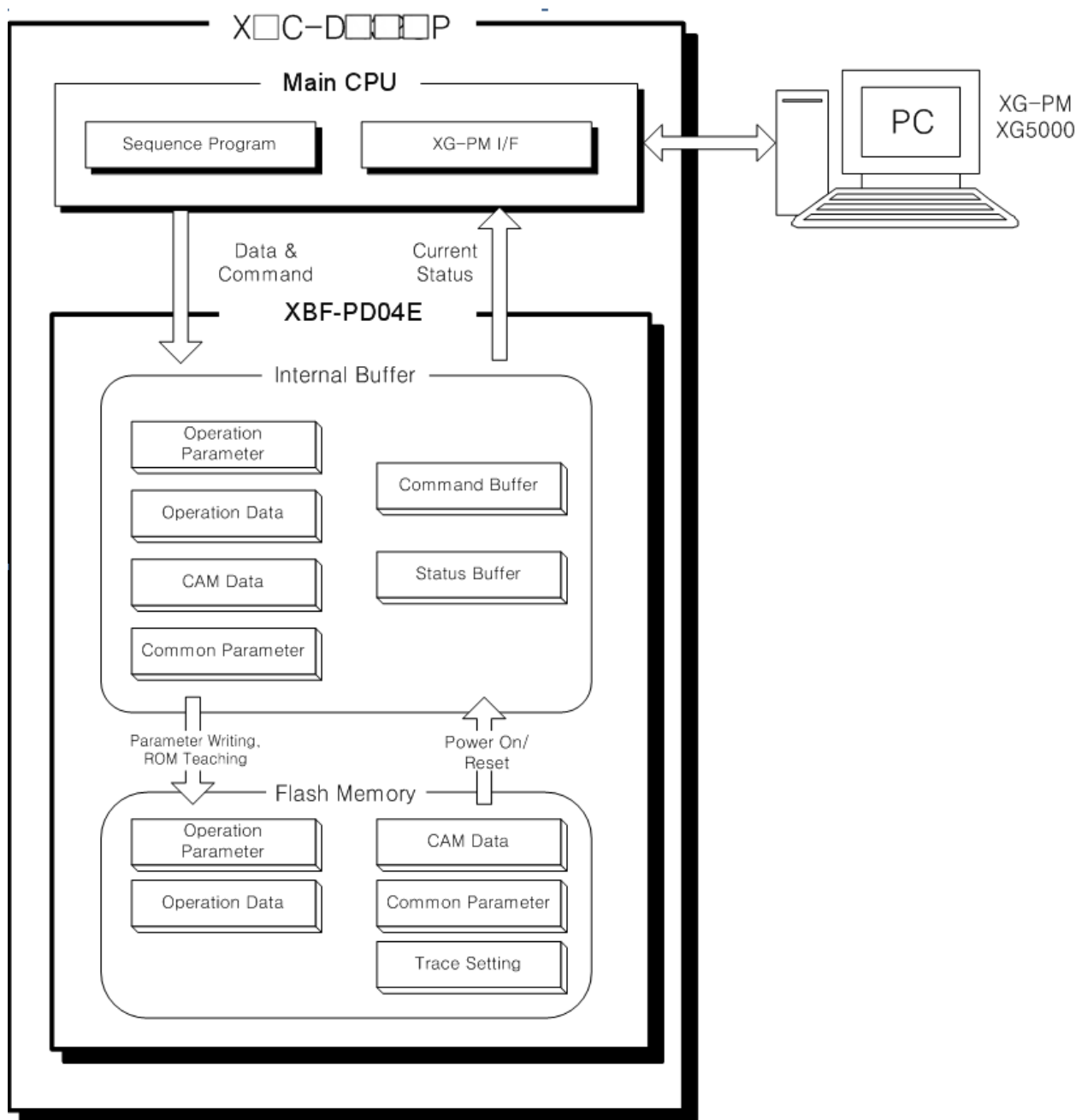

4.2 Basic Parameter

Here describes about basic parameter of embedded positioning.

4.2.1 Basic parameter

Item		Setting range
Speed limit 1)		mm : 1 ~ 2,147,483,647 [X10 ⁻² mm/min] Inch : 1 ~ 2,147,483,647 [X10 ⁻³ Inch/ min] degree : 1 ~ 2,147,483,647 [X10 ⁻³ degree/ min] pulse : 1 ~ 2,000,000 [pulse/Sec]
Acceleration time 1		0 ~ 2,147,483,647 [ms]
Acceleration time 2		
Acceleration time 3		
Acceleration time 4		
Deceleration time 1		0 ~ 2,147,483,647 [ms]
Deceleration time 2		
Deceleration time 3		
Deceleration time 4		
Deceleration time for EMG stop		0 ~ 2,147,483,647 [ms]
Pulse per revolution		1 ~ 200,000,000
Travel per revolution		mm : 1 ~ 200,000,000 [X10 ⁻⁴ mm] (1 ~ 200,000,000 [X10 ⁻¹ μm]) Inch : 1 ~ 200,000,000 [X10 ⁻⁵ Inch] degree : 1 ~ 200,000,000 [X10 ⁻⁵ degree]
Control word	unit (bit 2 ~ 3)	0:Pulse, 1:mm, 2:Inch, 3:Degree
	Unit multiplier(bit 4 ~ 5)	0: x 1, 1: x 10, 2: x 100, 3: x 1000
	Speed unit (bit 6)	0: unit/time, 1: rpm
Pulse output mode		0:CW/CCW, 1:PLS/DIR, 2:PHASE
Bias speed 2)		mm : 1 ~ 2,147,483,647 [X10 ⁻² mm/min] Inch : 1 ~ 2,147,483,647 [X10 ⁻³ Inch/ min] degree : 1 ~ 2,147,483,647 [X10 ⁻³ degree/ min] pulse : 1 ~ 2,000,000 [pulse/Sec]

1) The mm, inch, degree unit is not available when a value converted to the pulse/sec unit is greater than 2,000,000.

2) The bias speed can not greater than the speed limit.

Notes

For Deceleration time, when it stops by DEC. stop, DEC. time set in command is applied. At this time, if DEC. time is set as 0 in command, DEC. time set in basic parameter is applied. In case it stops by EMG stop because of internal factor, not external factor, EMG stop deceleration time in basic parameter is applied.

4.2.2 Basic parameter setting

(1) Unit

- (a) You can set the command unit for positioning control according to control object. The command unit (mm, inch, pulse, degree) can be set for each axis separately.
- (b) In case of changing the unit setting, as the value of other parameter and operation data does not change, the value of parameter or operation data should be set within the setting range of the unit to be changed.
- Ex) mm, inch, pulse : X-Y Table, Conveyor
degree : a body of rotation (360degree/revolution)

(2) Pulse per Revolution

- (a) Only in case of using mm, inch, degree as a positioning command unit, you should set pulse per revolution
- (b) In case of using SERVO, you should set the value of "the number of out put pulse per revolution".
If this value does not correspond with parameter value of servo drive, command and motor action may be different.
- Travel per pulse = Transfer per rotation (Al) / Pulse per rotation (Ap)
- Ex1) Speed: 60mm/min, Al:2000um, Ap: 200pls/revolution
60mm/min = 1mm/sec = 1000um/sec
1000um = 0.5 Revolution = 100pls
→ Pulse output speed is 100pls/sec when driving 60mm/min speed.

(3) Travel per rotation and unit multiplier

- (a) Only in case of using mm, inch, degree as a positioning command unit, you should set travel per revolution and multiplier
- (b) Actual Machine's travel distance per revolution of motor is determined by the structure of machine.
If the lead of ball screw (mm/rev) is PB and the rate of deceleration is 1/n,
Transfer amount per revolution (AL) = PB × 1/n.
- (c) Settable Travel per revolution (Al) is as below

Setting unit	mm	Inch	degree
Travel per revolution	0.1 ~ 20000000.0 um	0.00001 ~ 2000.00000 inch	0.00001 ~ 2000.00000 degree

In case Transfer amount per revolution (AL) exceeds the above range, The travel per rotation (Al) should be set as follows:

- Transfer amount (AL) = PB × 1/n = Travel per rotation (Al) × Unit multiplier (Am)

[Note]

In case unit is mm, unit multiplier (Am) can be 1, 10, 100, 1000.

If the value of "PB × 1/n" exceeds 20,000,000.0μm, it is required to adjust the unit multiplier so that the travel per rotation (Al) does not exceed 20,000,000.0μm.

Ex1) In case that (AL) = PB × 1/n = 2500000.0μm(= 2500mm)
→ Transfer amount per revolution (AL) = (Al) × (Am) = 25000000 × 1

Ex2) In case that (AL) = PB × 1/n = 25000000.0μm(= 25000mm)
→ Transfer amount per revolution (AL) = (Al) × (Am) = 25000000 × 10 = 2500000 × 100

(4) Speed Limit, Acceleration Time, Deceleration Time

(a) Speed Limit

The Speed limit means available maximum speed of positioning operation

All of the operating speed in positioning operation should be set to be lower than speed limit.

(b) Acceleration Time

Acceleration Time is the time required to reach the limit speed which is set by parameter from zero speed(stop state).

(It doesn't mean the time require to reach the Target speed)

(c) Deceleration Time

Deceleration Time is the time required to reach zero speed(stop state) from the limit speed which is set by parameter.

(It doesn't mean the time require to reach zero speed from the operating speed.)

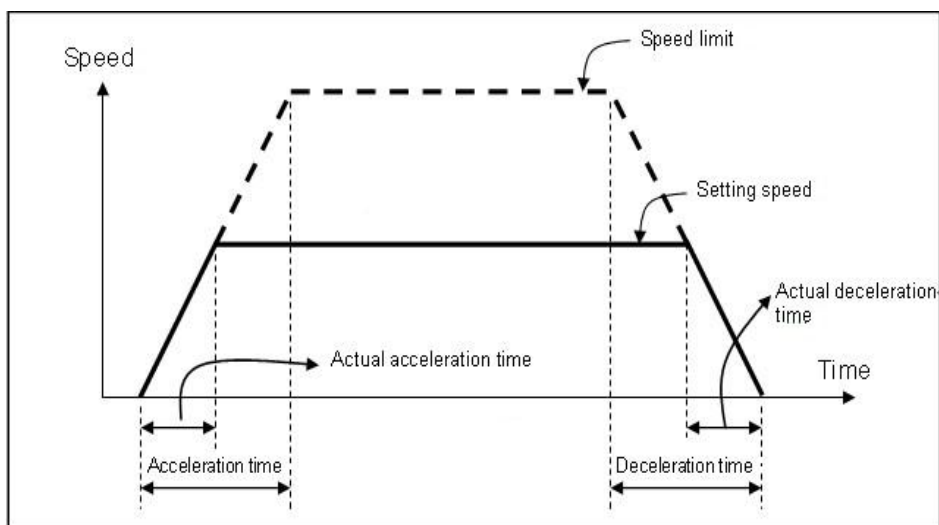

Chapter 4 Positioning Parameter & Operation Data

(5) Pulse Output Mode

Because the input method of each servo drive is different it is required to select pulse output mode of positioning according to the servo drives.

(a) CW/CCW mode

Forward pulse and reverse pulse are outputted from different terminal. The following figure shows pulse output diagram in case Active-low mode.

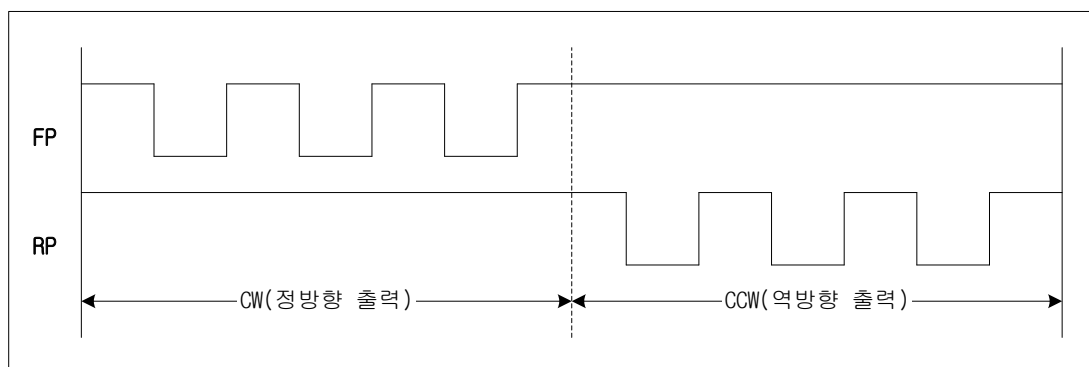

(b) PLS/DIR mode

Pulse is outputted from one terminal and the forward/reverse signal is outputted from the other terminal. The following figure shows pulse output diagram in case Active-low mode.

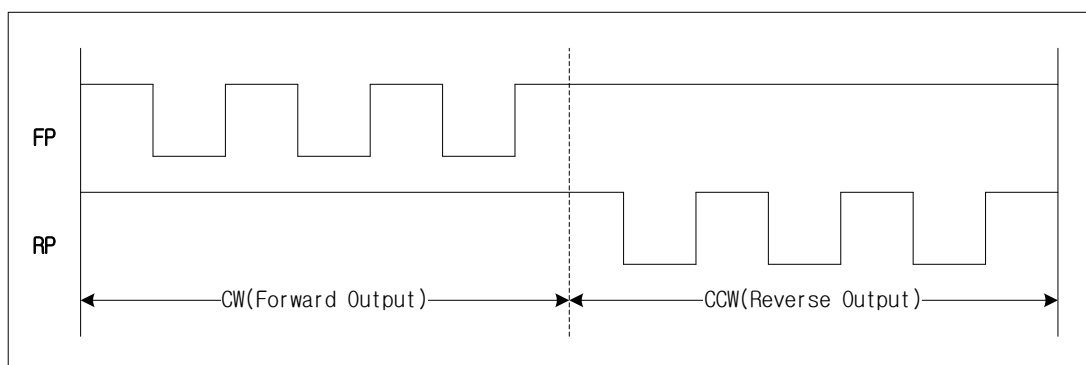

(c) PHASE 모드

Forward pulse and reverse pulse will be outputted with 90degree phase difference.

The following figure shows pulse output diagram in case Active-low mode.

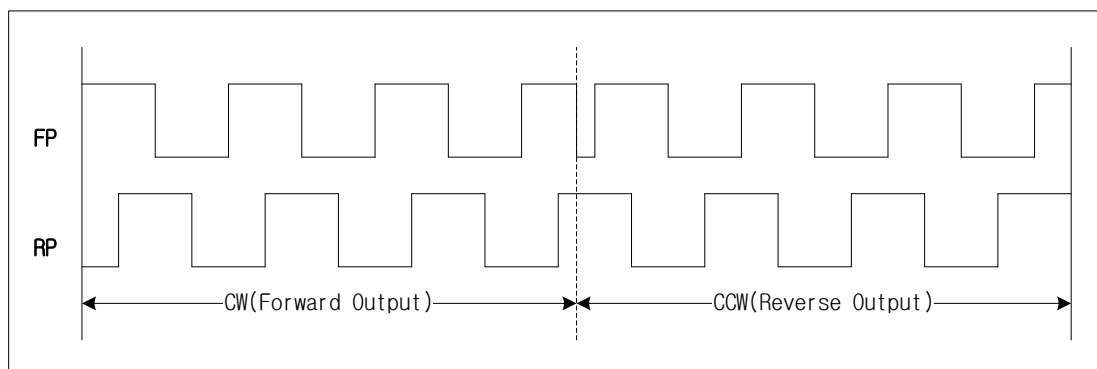

Chapter 4 Positioning Parameter & Operation Data

(6) Bias Speed

Because the stepping motor has unstable torque near zero speed, 0-bias speed is skipped in operation to smooth the rotation of motor and reduce the positioning time..

(a) The setting range is 0 ~ 2,000,000[pps] in case of pulse unit.

If the Unit parameter is not "Pulse", The bias speed should be not less than 1 when converted to "pulse unit" by Travel per revolution and pulse per revolution. if this value is smaller than 1, The PLC occurs error code "105" and adjust bias speed to satisfy above condition automatically .

[Note]

In case, Unit = mm, Pulse per revolution = 100 pls, Travel per revolution = 10000.0um, Unit multiplier
Available minimum bias speed can be calculated as below.

EX1) Travel per revolution (Al) = 10000.0um, Pulse per revolution(Ap)=1000pls

$$\begin{aligned} \text{Travel per pulse} &= \text{Travel per revolution (Al)} / \text{Pulse per revolution (Ap)} \\ &= 10000.0\text{um}/100\text{pls} \\ &= 10.0\text{um}/\text{pls} = 0.6\text{mm}/\text{min}. \end{aligned}$$

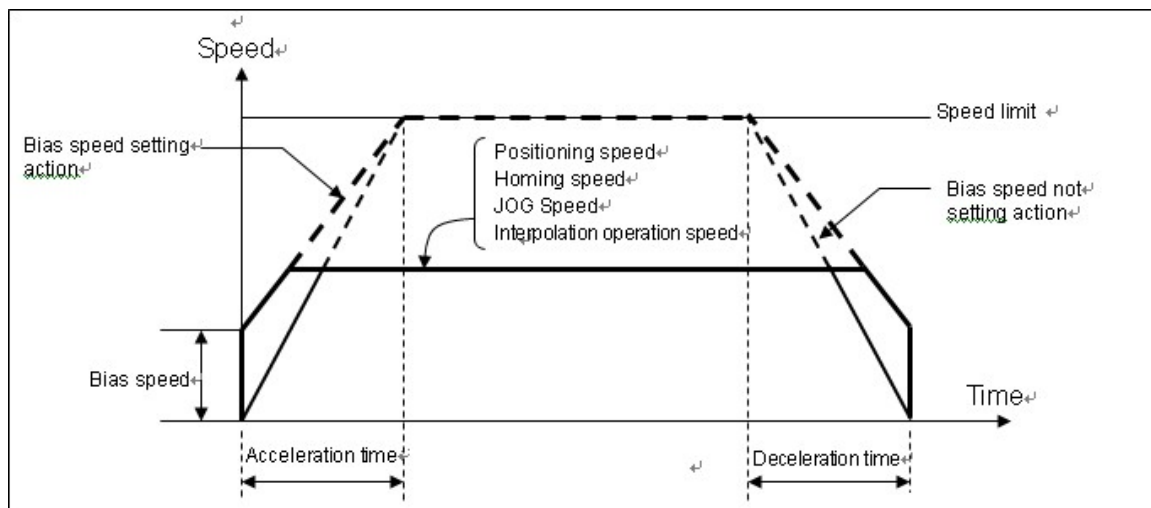

Note

1. If Bias speed is set as high, total operation time shall be reduced but if the setting value is too high, it may cause the occurrence of impact sound in the start/end time and forces the excessive effect to the machine. Cares shall be taken in using..
2. The bias speed should be set within the range as follows :
 - 1) Bias speed \leq Positioning speed data
 - 2) Bias speed \leq Homing-low speed \leq Homing-high speed
 - 3) Bias speed \leq JOG low speed \leq JOG high speed
3. It causes error in connection with bias speed in the following example..
 - 1) Bias speed $>$ Positioning speed data : error code 153
 - 2) Bias speed $>$ Homing-high speed : error code 133
 - 3) Bias speed $>$ Homing-low speed : error code 134
 - 4) Bias speed $>$ JOG high speed : error code 121
 - 5) Bias speed $>$ JOG low speed : error code 122
 - 6) Bias speed $>$ inching speed : error code 123
 - 7) Converted Bias speed $>$ 1pulse/s: error code 105

4.3 Extended Parameter

It describes about extended parameter of positioning module.

4.3.1 Contents of extended parameter

Extended parameter Items		Setting Range
Software upper limit		mm : -2,147,483,648 ~ 2,147,483,647[X10 ⁻⁴ mm] (-2,147,483,648 ~ 2,147,483,647[X10 ⁻¹ μm])
Software lower limit		Inch: -2,147,483,648 ~ 2,147,483,647[X10 ⁻⁹ Inch] degree: -2,147,483,648 ~ 2,147,483,647[X10 ⁻⁵ degree] pulse: -2,147,483,648 ~ 2,147,483,647[pulse]
Infinite running repeat position		mm: 1 ~ 2,147,483,647[X10 ⁻⁴ mm] (1 ~ 2,147,483,647[X10 ⁻¹ μm]) Inch: 1 ~ 2,147,483,647[X10 ⁻⁹ Inch] degree: 1 ~ 2,147,483,647[X10 ⁻⁵ degree] pulse: 1 ~ 2,147,483,647[pulse]
Backlash compensation amount		mm: 0 ~ 65,535[X10 ⁻⁴ mm] (0 ~ 65,535[X10 ⁻¹ μm]) inch: 0 ~ 65,535[X10 ⁻⁹ Inch] degree: 0 ~ 65,535[X10 ⁻⁵ degree] pulse: 0 ~ 65,535[pulse]
Position completion time		0 ~ 65,535[ms]
S-Curve ratio(%)		1 ~ 100
Arc insertion position in 2-axis linear interpolation continuous operation		mm: 0 ~ 2,147,483,647[X10 ⁻⁴ mm] (0 ~ 2,147,483,647[X10 ⁻¹ μm]) Inch: 0 ~ 2,147,483,647[X10 ⁻⁹ Inch] degree: 0 ~ 2,147,483,647[X10 ⁻⁵ degree] pulse: 0 ~ 2,147,483,647[pulse]
Servo reset output ON duration		1~5000[ms]
Control word	Pulse output direction (bit 0)	0: CW, 1: CCW
	Acceleration/Deceleration pattern (bit 1)	0:Trapezoid operation, 1:S-Curve operation
	M Code mode(bit 2 ~ 3)	0: NONE, 1: WITH, 2: AFTER
	Interpolation speed selection (bit 4)	0: main axis speed, 1: synthetic speed
	Software limit detection during speed control (bit 5)	0:Don't detect, 1: Detect
	Reserved (bit6)	-
	External stop selection (bit7)	0: Emergency stop, 1: Deceleration stop
	Reserved (bit 8)	-

Chapter 4 Positioning Parameter & Operation Data

Extended parameter Items		Setting Range
Control word	Speed/Position switching coordinate (bit 9)	0: Incremental, 1: Absolute
	Reserved (bit 10 ~ 11)	-
	Infinite running repeat (bit 12)	0: Disable, 1: Enable
	Interpolation continuous operation Type (bit 13)	0 : Pass target position, 1 : Pass near position
	Arc insertion in 2-axis linear interpolation continuous operation (bit 14)	0 : Don't insert , 1 : Insert arc continuous operation
Pos.-specified speed override coordinate (bit 15)	0: absolute, 1: incremental	

4.3.2 Extended parameter setting

(1) Software upper/Lower Limit

- (a) The function is designed so that the machine does not execute the positioning operation out of the range by setting the range of machine available to move through software upper limit and software lower limit. That is, this function is used to prevent any breakaway by incorrect operation position setting and incorrect operation by user program fault.
- (b) External input upper/lower limit can be also set besides the software upper/lower limit.

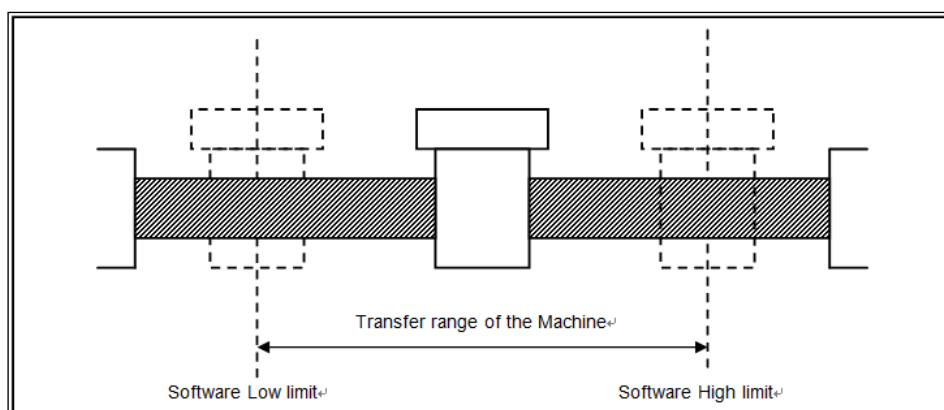

- (c) The range check of software upper/lower limit is done at the start of operation and during operating.
- (d) If the software upper/lower limit is detected, error (Software upper limit error: 501, Software lower limit error: 502) occurs and the pulse output of positioning module shall be disabled. Therefore, when you want to operate again, it is required to reset error and release the 'output inhibition' before using.
- (e) Setting range

Unit	Software upper/lower limit range
pulse	-2,147,483,648 ~ 2,147,483,647[pulse]
mm	-2,147,483,648 ~ 2,147,483,647[X10 ⁻⁴ mm]
Inch	-2,147,483,648 ~ 2,147,483,647[X10 ⁻⁵ Inch]
degree	-2,147,483,648 ~ 2,147,483,647[X10 ⁻⁵ degree]

* Software upper limit value always should be higher than software lower limit, at least same

- (f) If the software upper/lower limit was set by default value (upper limit: 2,147,483,647, lower limit: -2,147,483,648) or same value, then it wouldn't detect upper/lower limit.

(2) Infinite running repeat position

- (a) When using “Infinite running repeat” mode, it sets the repeated position value.
- (b) This is applied when “Infinite running repeat” in the extended parameter is “1: Enable”. When this parameter setting value is “0: Disable”, command position and current position is expressed within position expression range according to value set in “Unit” of basic parameter.
- (c) When “Infinite running repeat” parameter is “1: enable”, command position and current position is expressed as 0 ~ “infinite running repeat position-1”.

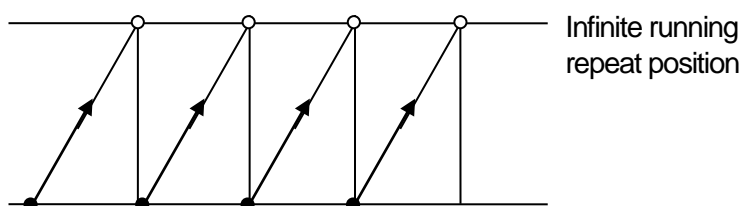

(d) Setting range

Unit	Infinite running repeat position range
pulse	1 ~ 2,147,483,647[pulse]
mm	1 ~ 2,147,483,647[X10 ⁻⁴ mm]
Inch	1 ~ 2,147,483,647[X10 ⁻⁵ Inch]
degree	1 ~ 2,147,483,647[X10 ⁻⁵ degree]

(3) Infinite running repeat

- (a) It sets whether to enable or disable “Infinite running repeat”
- (b) When you set “Infinite running repeat” as “1: enable”, command position and current position refreshes within the range set in “Infinite running repeat position” periodically.
- (c) When you don’t use “Infinite running repeat” function, set as “0: disable”.

(4) Backlash Compensation Amount

- (a) In case that a gear, screw etc is combined to the motor axis, The tolerance that the machine does not work by the wear, when the rotation direction changes, is called as ‘Backlash’. Therefore, when you change the rotation direction, it is required to add the backlash compensation amount to the positioning amount for output.
- (b) This is used for positioning operation, inching operation and jog operation
- (c) Setting range

Unit	Backlash setting range
pulse	0 ~ 65,535[pulse]
mm	0 ~ 65,535[X10 ⁻⁴ mm]
Inch	0 ~ 65,535[X10 ⁻⁵ Inch]
degree	0 ~ 65,535[X10 ⁻⁵ degree]

Chapter 4 Positioning Parameter & Operation Data

(d) As presented in the following figure, if the position moved 1m to the right and again 1m to the left, it is not possible to reach the original position by backlash. At this time, it is required to add backlash compensation amount.

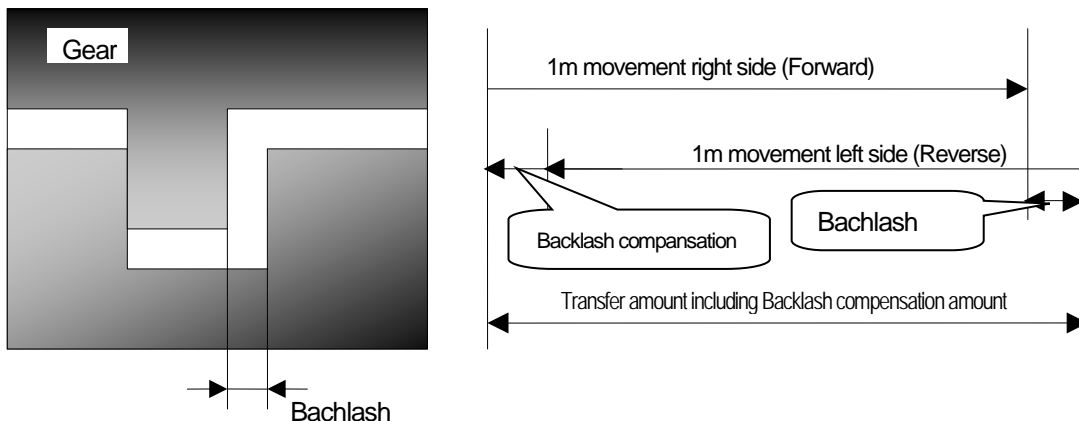

(e) It compensates by adding backlash compensation pulse to current output pulse within speed limit.
 In case backlash compensation amount is bigger than Max. output Pulse ($\text{Speed limit} \times \text{Control cycle}$) for one control cycle, distribute compensation amount to several control cycles

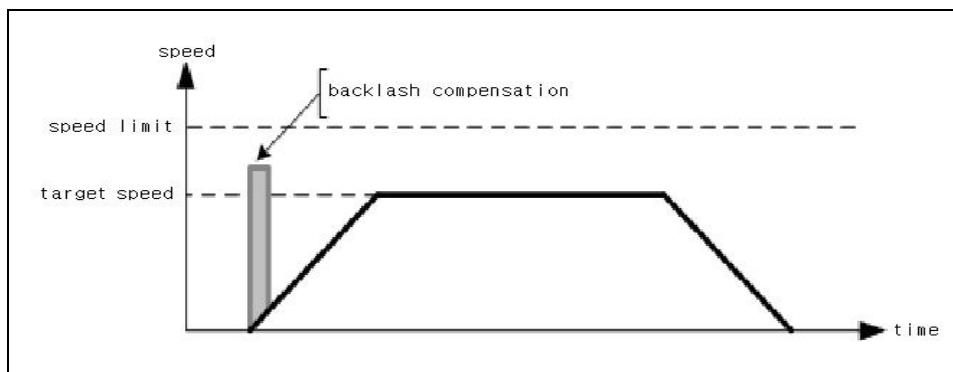

A,B,C,D : Relative position

P0 ,P1,P2,P3 : transfer amount of load

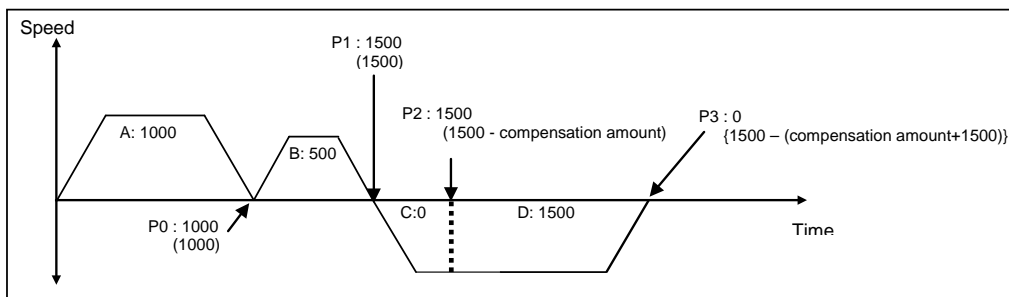

Notes

In case backlash compensation is bigger than Max. Pulse (Speed limit x Control cycle) for one control cycle, progress is as shown below. For example, in case that Speed limit is 100000 and backlash is 250, backlash compensation is bigger than Max. output Pulse ($100000\text{pps} \times 0.001\text{s} = 100$) for one control cycle, and performed for several control cycles. In this case, the number of output pulse which comes from positioning module per one control cycle is different according to Acc. time. Compensation pulse is added to above pulse for total pulse output to be smaller than Max. output pulse for one control cycle. So the number of control cycle compensation acts is different.

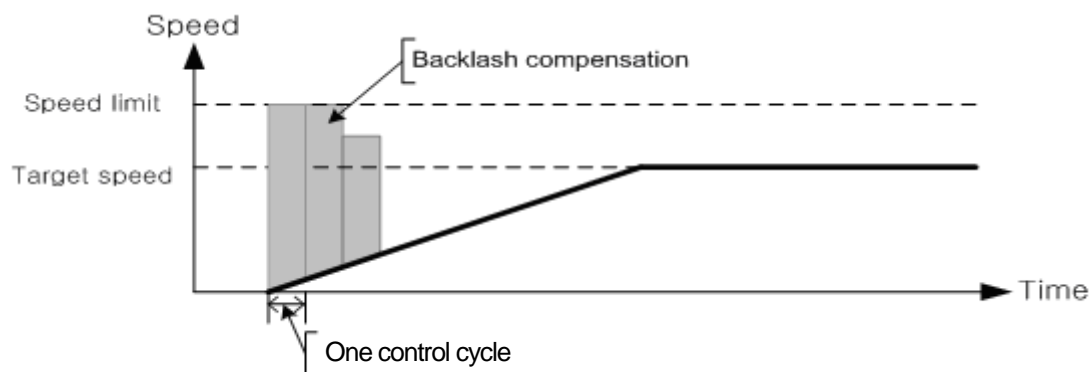
**(5) Positioning Completion Time**

(a) Positioning completion signal shall be OFF after sustaining "ON" for Positioning Completion Time after positioning is completed and positioning completion signal becomes "ON" in single operation, repeat operation, keep operation, continuous operation, linear interpolation operation, circular interpolation operation, speed/position switching control operation, inching operation

At this time, if all start command is executed while positioning completion signal is ON, completion signal shall be OFF immediately. In case of keep operation and continuous mode operation, positioning completion signal will be on after all steps end.

(b) The setting range is 0 ~ 65,535 (unit: 1ms).

(c) The action of single operation mode is as follows.

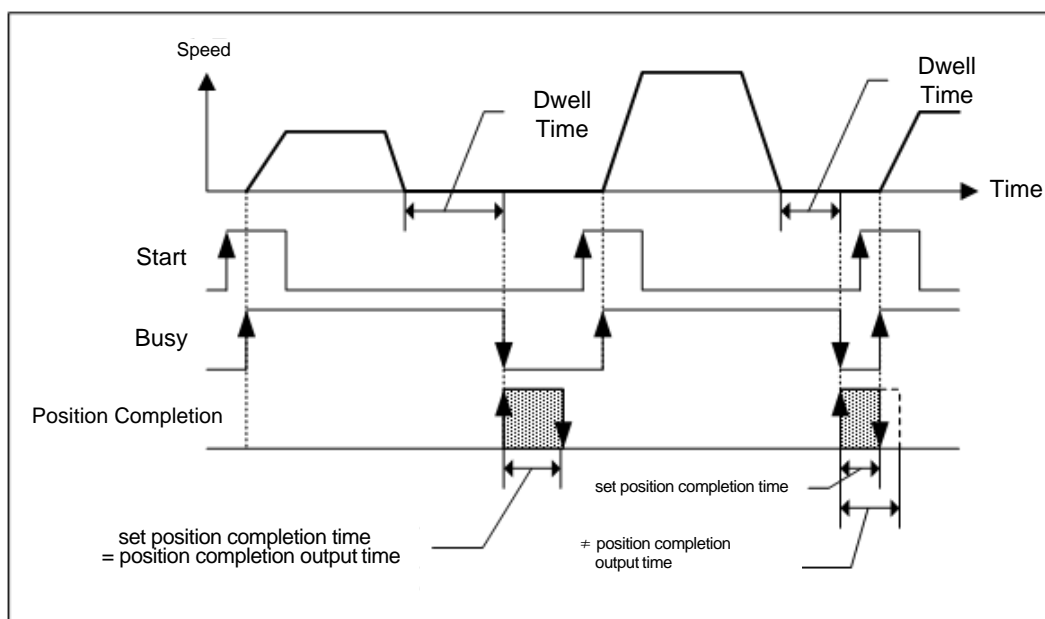

(d) The action of Keep operation mode is as follows :

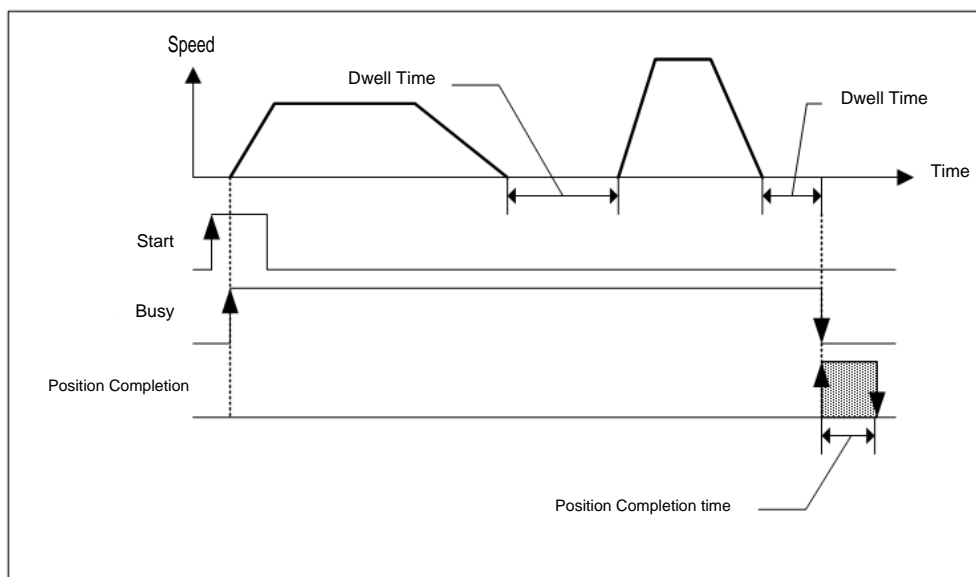

(e) The action of Continuous operation mode is as follows.

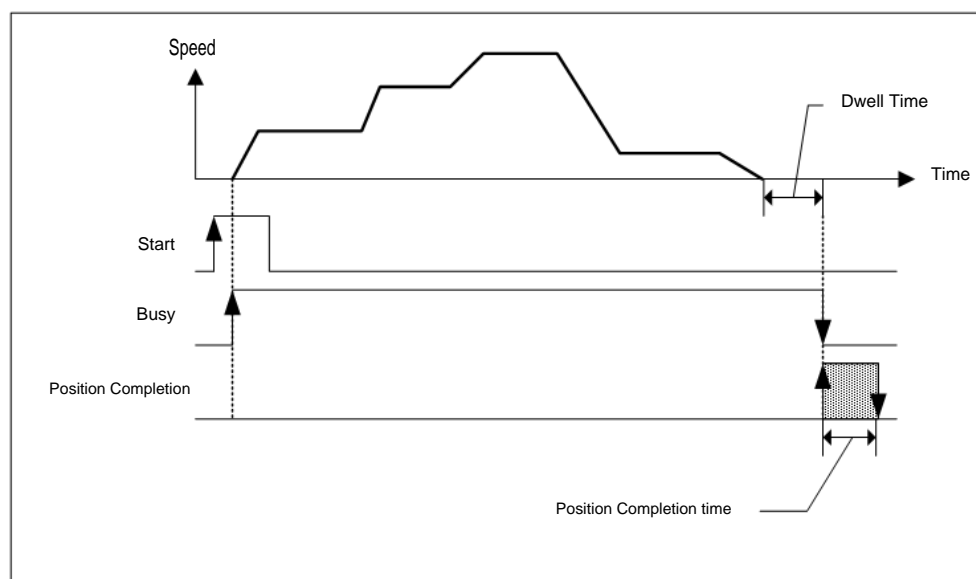

Chapter 4 Positioning Parameter & Operation Data

(6) Pulse output direction

- This is used to set machine's actual movement direction according to pulse output direction (rotation direction of motor) of positioning function.
- If pulse output direction is set as "CW" and machine moves forward direction in case of forward direction operation, it is set correctly.
- If pulse output direction is set as "CW" and machine moves reverse direction in case of forward direction operation, it is not set correctly. Set the pulse output direction as "CCW". In case of forward direction operation, if machine moves forward direction, it is set correctly.
- In the following figure, pulse output level is set as Low Active"

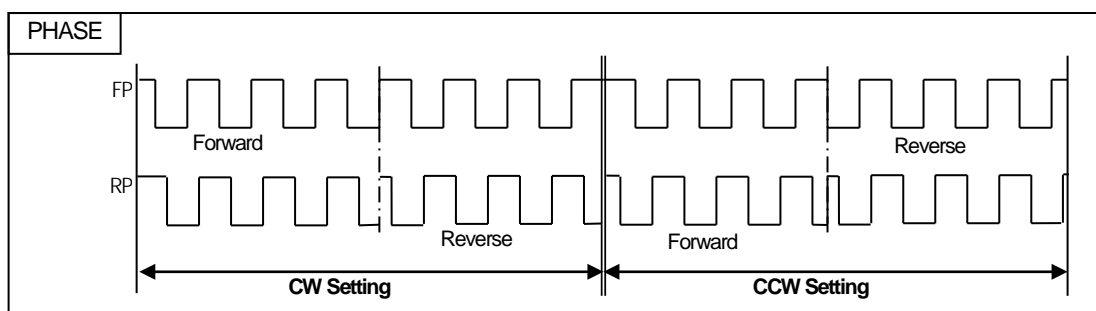
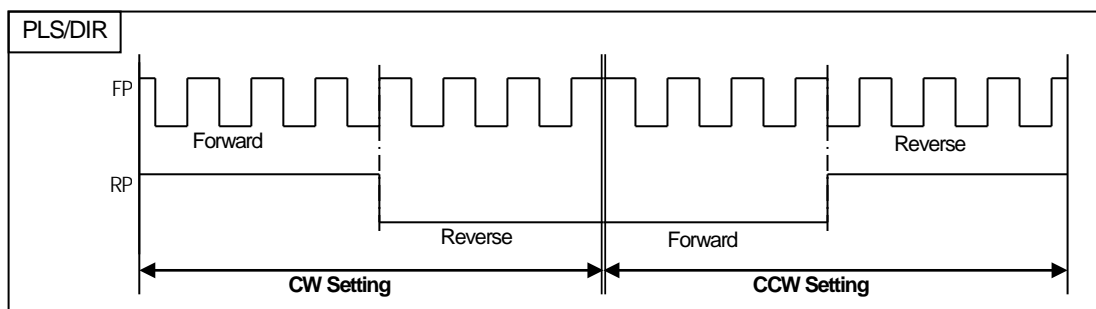
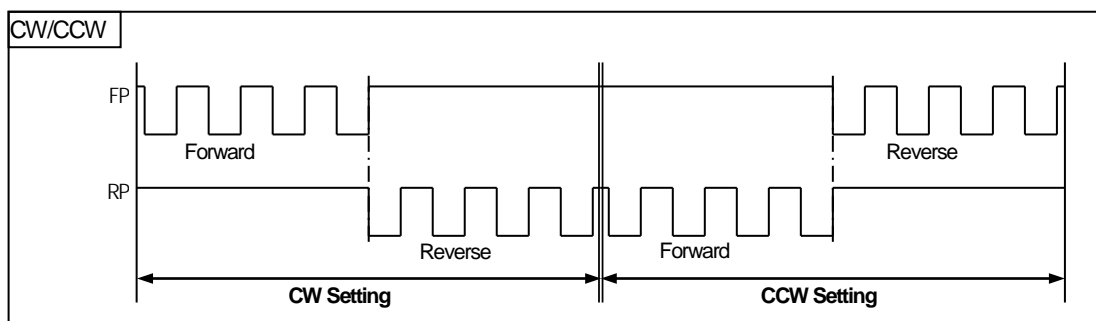

Chapter 4 Positioning Parameter & Operation Data

(7) M Code Output

- (a) M code mode set by parameter shall be applied to all positioning data of the corresponding axis.
- (b) Available to set M code number differently at each operation step no. of positioning data.
- (c) M code number setting range : 1 ~ 65,535
- (d) Available to read and use M code for the identification of operation step no. in operation and the execution of auxiliary works (Clamp, tool change etc).
- (e) M code signal occurring during the operation shall be reset by "MOF" command.

Notes

If you execute the next step after the positioning is completed and M code signal is "ON", the next operation step no. does not work and the error code(233) will occur. Therefore, in order to execute the positioning of the next operation step number, M code signal should be "OFF" by "MOF" command

- (f) There are two kinds of M code mode according to the output timing of M code signal: With mode and After mode
(In case of setting NONE, There is no M code signal, even if M code No. was set.)

1) With mode

It turns on the M code signal and outputs M code number with start of positioning [Indirect start, direct start and simultaneous start].

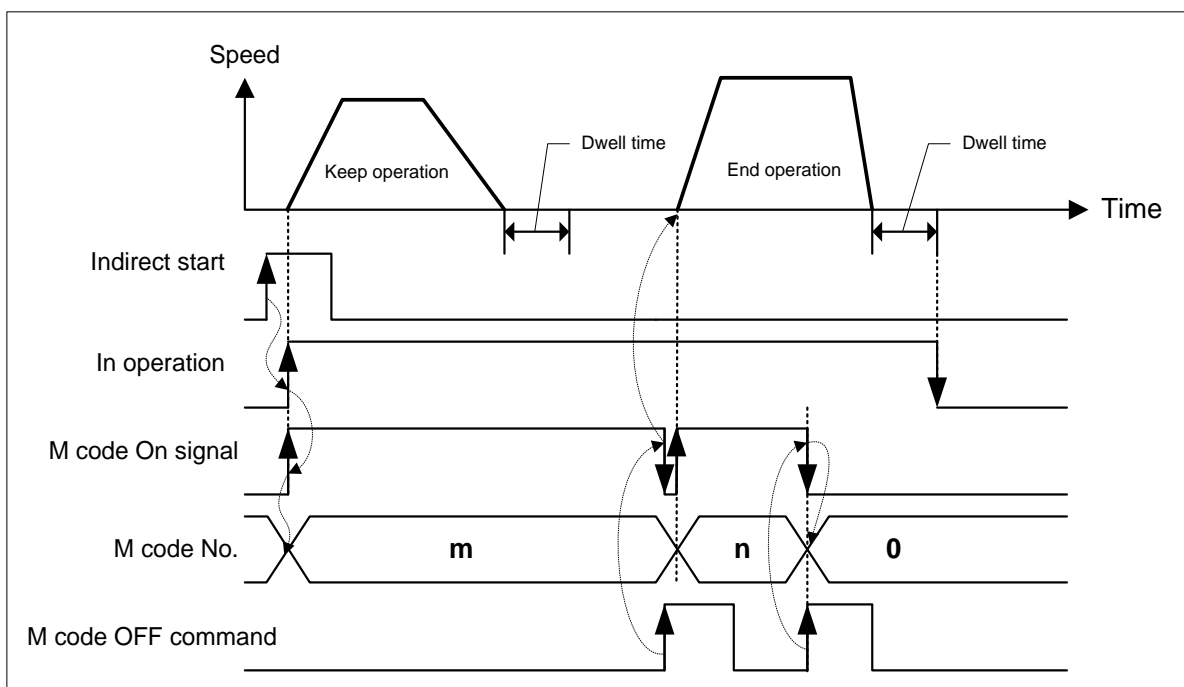

2) After mode

It turns on the M code signal and outputs M code number after completion of positioning [indirect start, direct start and simultaneous start].

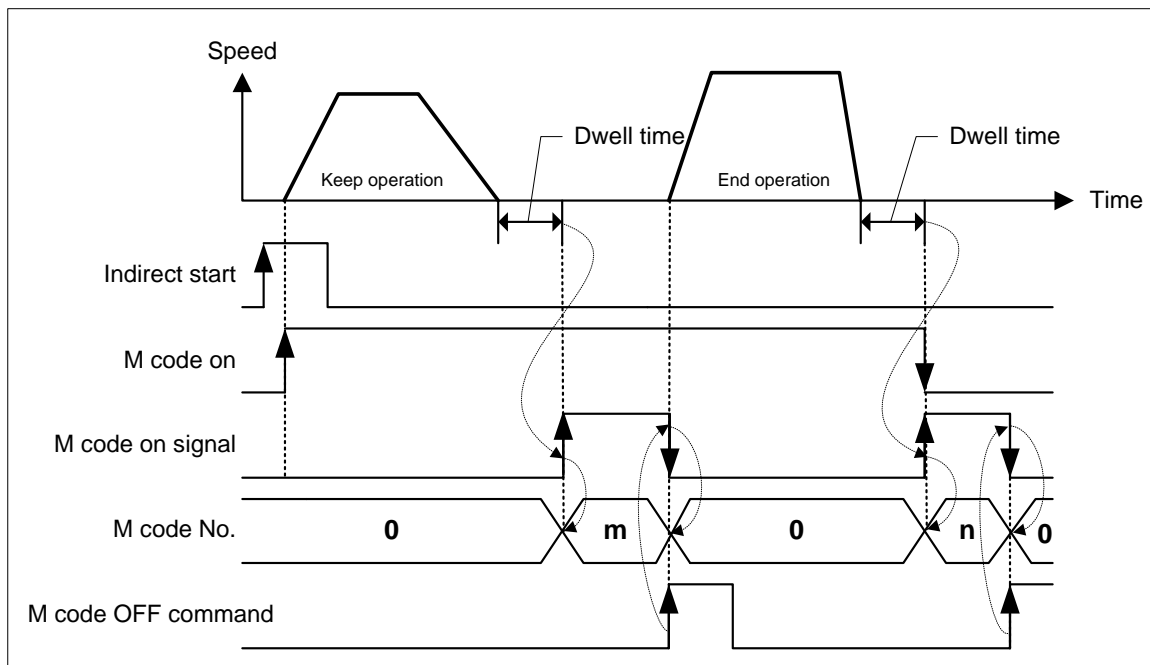

(8) Interpolation speed selection

It selects whether to consider the operation speed of the position data as main axis speed or synthetic speed.

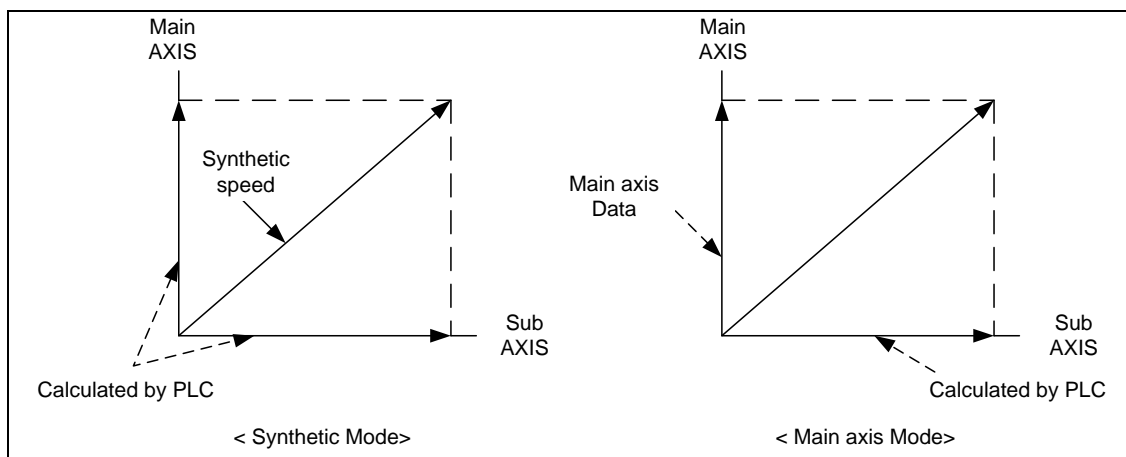

(9) External stop selection

Selects external stop type between EMG. stop and Dec. stop

(10) Software limit detect

(a) Selects whether to stop the operation or not when detecting software limit.

(b) If the software upper/lower limit is set as default value (upper limit: 2,147,483,647, lower limit: -2,147,483,648) or same value, it wouldn't detect software upper/lower limit.

(11) Acceleration/Deceleration Pattern

- There are 2 kinds of Acceleration/Deceleration operation pattern: Trapezoid operation and S-Curve operation.
- In case of positioning operation, it is available to select operation pattern (either trapezoid operation or S-Curve operation) at the section of acceleration and de deceleration.
- As it is not possible to use S-Curve operation pattern in case of continuous operation mode and speed override, care should be taken in setting.
- By using S-Curve acceleration/deceleration, it is available to protect the motor from the load effect at the point that the motor starts to move the moving object and stops it.

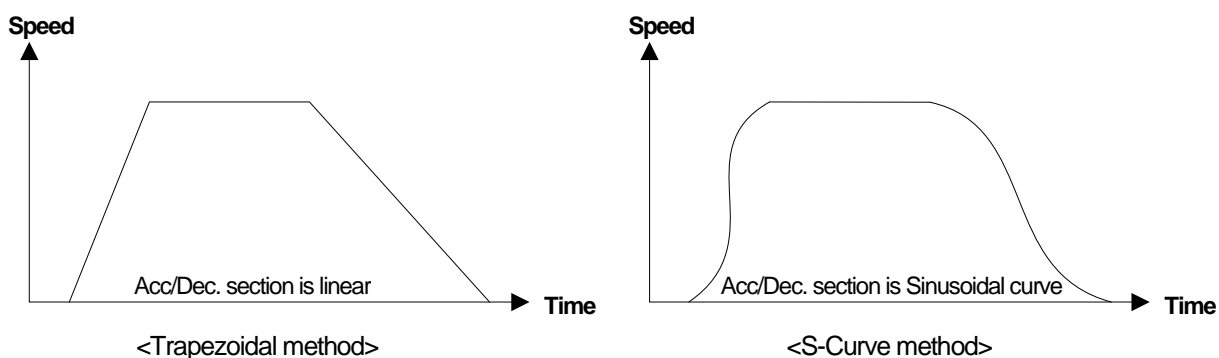

(12) S-curve rate

- In case of selecting S-Curve operation as an acceleration/deceleration pattern, S-Curve rate (1~100%) should be set.
- According to S-Curve rate, S-Curve operation pattern shall be formed in accordance with Sinusoidal curve.
- If S-Curve rate is 1%, it becomes the same as trapezoid operation and if the 100% rate is set, it becomes the acceleration/deceleration curve which is the closest to the Sinusoidal Curve.
- The figure as below shows the example of S-Curve rate setting

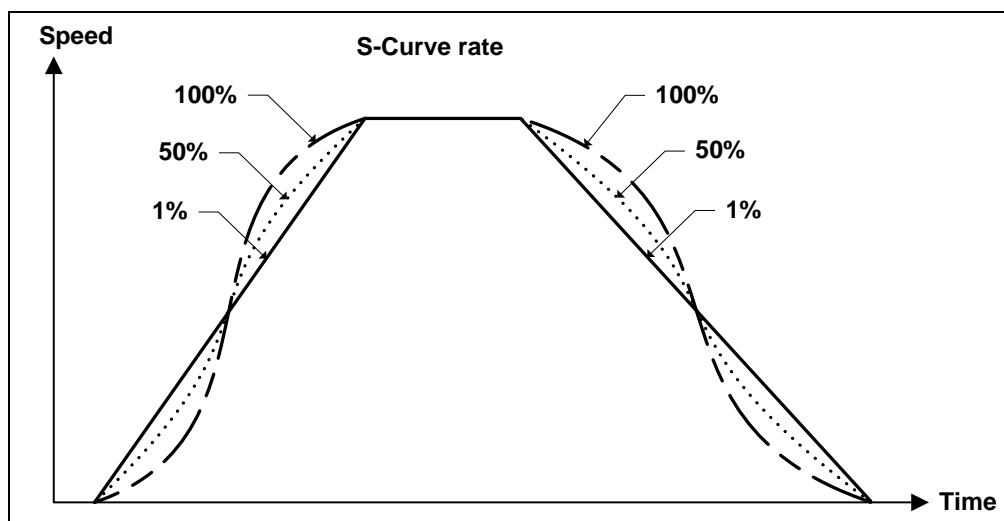

Chapter 4 Positioning Parameter & Operation Data

(13) Linear interpolation positioning method

In case control method is linear interpolation or circular interpolation and operation method is continuous operation, positioning control will be different in accordance with the value set in "Int continuous opr. Type".

The two method types of interpolation control continuous operation are as follows;

- Pass target position (Passes designated target position)
- Pass near position (Before reaching target position of current step, moves to target position of next step)

Setting range of the Interpolation continuous operation positioning method is as follows;

Items	Setting value	Description
Interpolation continuous operation method	0 : Pass target position	In case of continuous operation from current step to next step, it passes target position of current step .
	1 : Pass near position	In case of continuous operation from current step to next step, it passes near target position of current step

For further information, please refer to operation mode (4) continuous operation of 8.2.2 positioning control.

(14) Arc insertion during 2-axis linear interpolation continuous operation

When executing linear interpolation, determine whether to add arc during 2-axis linear interpolation continuous operation.

Here describes Arc insertion during 2-axis linear interpolation continuous operation

Setting item	Setting Value	Content
Arc insertion during 2-axis linear interpolation continuous operation	0 : Don't insert	When executing 2-axis linear continuous interpolation, doesn't inserts arc. .
	1 : insert arc	When executing 2-axis linear continuous interpolation, inserts arc.

For further information about Arc insertion during 2-axis linear interpolation continuous operation, please refer to (4) 2-axis linear interpolation continuous operation arc insertion of 2-axis linear interpolating control of 8.2.6.

(15) Arc insertion position

When 「Arc insertion」 was set as "insert arc", confirm the position where it was set by 'inputting circular arc continuous operation', reset start position of circular interpolation(Goal position of linear path 1) and goal position

(Start position of linear path 2).

This is the setting of 'Position-specified speed override coordinate'.

Item	Setting value	Content
Position of inputting circular arc from axis 2 linear interpolation continuous operation	0 ~ 2,147,483,647	Set the position that circular will be inputted. It is relative distance from goal position..

For further information about inputting circular arc from axis 2 linear interpolation continuous operation, please refer to (4) inputting circular arc from axis 2 linear interpolation continuous operation of control linear interpolation (8.2.6).

Chapter 4 Positioning Parameter & Operation Data

(16) Position-specified speed override coordinate

Position-specified speed override command is the command changing the operation speed when the object reaches the specified position. At this time, operation may be different according to the type of position value. Position value can be absolute position value or incremental position value.

This is the setting of 'Position-specified speed override coordinate'.

Item	Setting value	Content
Position-specified speed override coordinate	0 : ABS	Speed changes at the specified absolute position.
	1 : INC	Speed changes at the position as far as the set value from start position.

For further information, refer to 8.5.6 position-specified speed override.

(17) Speed/Position switching coordinate

If "Speed/Position switching command" is executed during speed control, speed control changes into position control and executes position control with the value set in target position. At this time, this sets whether to consider the target position as absolute position value or incremental position value.

This is the setting of "Speed/Position switching coordinate".

Item	Setting value	Content
Speed/position switching coordinate	0 : INC	Executes positioning as far as the set value from position where speed/position switching command is executed.
	1 : ABS	Considers the set value as absolute position and executes positioning into the set absolute position.

For further information, refer to 9.2.14 speed/position switching control.

(18) Servo reset output On duration time

When servo drive has occur alarm, PLC can clear alarm using ALMRST signal. This parameter set the On duration time of servo alarm reset output. When servo reset command is executed, RSTOUT signal is turned on during the time designated on extended parameter. refer to the servo driver user's manual for the proper value of this parameter. Available setting range is 1~ 5,000[ms]

4.4 Manual Operation Parameter

Here describes Manual operation parameter of embedded positioning.

Manual operation parameter use in event that operation of JOG, Inching is used

4.4.1 Manual Operation Parameter

Manual operating parameter item	Setting range
JOG high speed	mm : 1 ~ 2,147,483,647 [$X10^{-2}$ mm/분] Inch : 1 ~ 2,147,483,647 [$X10^{-3}$ Inch/분]
JOG low speed	degree : 1 ~ 2,147,483,647 [$X10^{-3}$ degree/분] pulse : 1 ~ 2,000,000 [pulse/초]
JOG acceleration speed (ms)	0 ~ 2,147,483,647 [ms]
JOG deceleration speed (ms)	
Inching Speed	mm : 1 ~ 65,535 [$X10^{-2}$ mm/min] Inch : 1 ~ 65,535 [$X10^{-3}$ Inch/min] degree : 1 ~ 65,535 [$X10^{-3}$ degree/min] pulse : 1 ~ 65,535 [pulse/sec]

4.4.2 Manual Operation Parameter Setting

(1) JOG high Speed

- (a) Jog speed is related to Jog operation (a kind of manual operation) and has 2 types of operation : Jog low speed operation and Jog high speed operation.
- (b) For further information, please refer to 8.3.1 JOG Operation.
- (c) JOG high speed operation has operation pattern as acceleration, constant speed, deceleration section. Therefore, acceleration section and deceleration section is controlled by JOG acceleration/deceleration time.
- (d) Jog high speed setting range
All of control by embedded positioning is made within speed limit. Therefore, jog high speed also couldn't exceed the speed limit and must be larger than jog low speed.
(Notices when setting the high speed : Bias speed \leq Jog low speed \leq Jog high speed \leq Speed limit)

(2) JOG Low Speed

- (a) JOG low speed operation has operation pattern as acceleration, constant speed, deceleration section.
- (b) JOG low speed setting range : Bias speed ~ Jog high speed

(3) JOG Acceleration/Deceleration Time

- (a) This means JOG acceleration/deceleration time when Jog high speed and low speed operation.
- (b) JOG acceleration/deceleration time setting range : 0 ~ 2,147,483,647 [ms]
In case of 0, operates according to acceleration time 1 and deceleration time 1 of parameter..

(4) Inching Speed

- (a) The speed necessary for inching operation is set here.
- (b) Inching speed setting range : 1 ~ 65,535(unit: 1pps)

4.5 Homing Parameter

Here is describes about homing parameter of embedded positioning.

Homing parameter is needed when positioning module return to origin.

4.5.1 Homing Parameter

Homing Parameter option		Setting range
Origin address		mm : -2147483648 ~ 2147483647 [X10 ⁻⁴ mm] (-2147483648 ~ 2147483647 [X10 ⁻¹ μm]) Inch : -2147483648 ~ 2147483647 [X10 ⁻⁵ Inch] degree : -2147483648 ~ 2147483647 [X10 ⁻⁵ degree] pulse : -2147483648 ~ 2147483647 [pulse]
Homing-high speed		mm : Bias Speed ~ Speed Limit(Homing Low Speed<=Homing high Speed) Inch : Bias Speed ~ Speed Limit(Homing Low Speed<=Homing high Speed)
Homing-low speed		degree : Bias Speed ~ Speed Limit(Homing Low Speed<=Homing high Speed) pulse : Bias Speed ~ Speed Limit(Homing Low Speed<=Homing high Speed)
Homing Acceleration time		0 ~ 2,147,483,647 [ms]
Homing deceleration time		
Homing dwell time		0 ~ 65,535[ms]
Origin compensation amount		mm : -2147483648 ~ 2147483647 [X10 ⁻³ mm] (-2147483648 ~ 2147483647 [X10 ⁻¹ μm]) Inch : -2147483648 ~ 2147483647 [X10 ⁻⁵ Inch] degree : -2147483648 ~ 2147483647 [X10 ⁻⁵ degree] pulse : -2147483648 ~ 2147483647 [pulse]
Homing restart waiting time		0 ~ 65,535[ms]
Control word	Homing mode(bit 0 ~ 2)	0:Dog/Home(Off), 1: Dog/Home (On), 2:Upper-Lower Limit/Home, 3:Dog, 4:High Speed Homing, 5: Upper-Lower Limit, 6: Home
	Homing direction(bit 3)	0:forward direction, 1:reverse direction

4.5.2 Homing parameter setting

(1) Homing Method

(a) There are 7 kinds of Homing method.

Homing method	XG-PM Software package indication
Origin detection after DOG OFF	0: DOG/origin(OFF)
Origin detection after deceleration when DOG ON	1: DOG/origin(ON)
Origin detection by the origin and Upper/Lower limit	2: High/low limit/origin
Origin detection by DOG	3: DOG
High speed homing	4: High speed origin
Origin detection by Upper/Lower limit	5: High/low limit
Origin detection by HOME	6: HOME

(b) For further information of homing method, please refer to 8.1 homing of chapter 8

(2) Homing direction

(a) There are 2 kinds of homing direction, forward direction and reverse direction.

(b) In case of homing command was set by forward, begin to homing operation to currently increasing direction of position, searching needed external signal for homing.

(c) In case of homing command was set by reverse, begin to homing operation to currently decreasing direction of position, searching needed external signal for homing.

(3) Origin Address

(a) When homing is completed by homing command, the value set by homing address shall be used to change the present address value.

(b) Setting range of homing address: -2,147,483,648 ~ 2,147,483,647(unit: pulse)

(4) Origin compensation amount

- If the machine origin is deviated slightly – the difference between the setting value and the actual transfer amount caused by the mechanical tolerance - at the origin detection (Z phase input), this is used to compensate the tolerance.
- If origin compensation amount is set, PLC outputs additional pulses as much as data amount set as origin compensation amount after detecting origin. If origin compensation amount is (+), it moves to the homing direction. if origin compensation amount is (-), it moves to the opposite direction of homing.
- Origin compensation amount setting range : -2,147,483,648 ~ 2,147,483,647 (unit: pulse)
- This picture is one of the examples about homing method that was applied by homing compensation amount from “Origin detection after DOG OFF”.

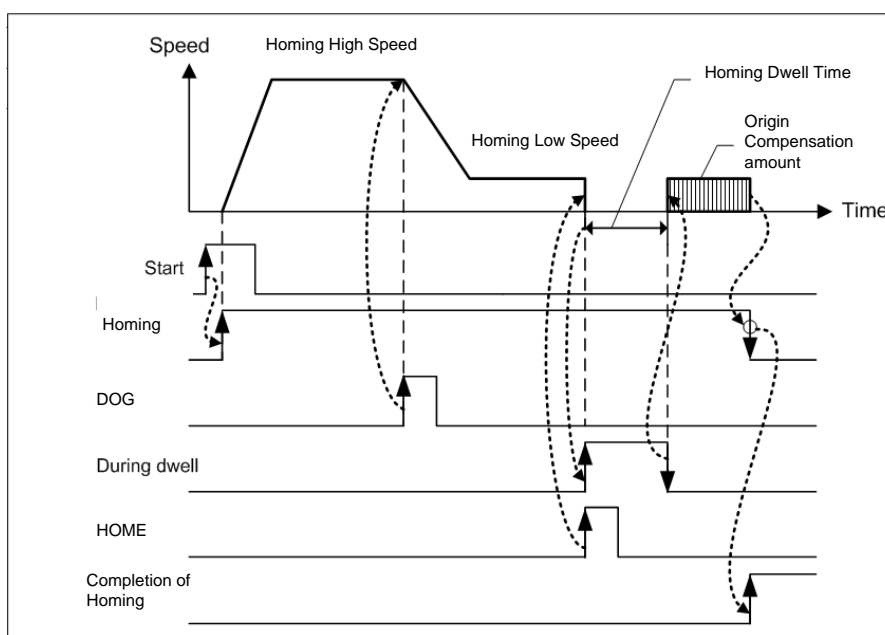

(5) Homing-High speed

- There are 2 kinds of homing speed : high speed and low speed.
- There is two stage in homing action ; ‘Detecting Home’& ‘Detecting Home area’.
PLC stop moving immediately when detects the Home signal. therefore when homing speed is fast, there can be difference between "the origin signal" and "the stopped position of machine" . Therefore, The moving speed must be low enough to stop in the correct home signal position and this speed is "homing low speed". But, need to move as fast as possible until detecting " Home Area(DOG)". This speed is is "homing High speed".
- All of the control by positioning module doing work within speed limit. And Homing high speed also can't exceed speed limit. And, Homing high speed must be faster than or same with homing low speed.
 - Bias speed \leq Homing-low speed \leq Homing-high speed \leq Speed limit

(6) Homing-Low speed

- The speed that acts to the constant speed section from high speed section via deceleration section by homing command.

Notes

When setting the homing speed, it is recommended to set the homing-low speed as low speed as possible.
If setting the low speed as “too fast”, it may cause the incorrect origin signal detection.

(7) Homing restart waiting time

- (a) It is standby time until restart "Homing" automatically in case that can't complete "Homing" by detection of high/low limit during homing operation. (b) Motor do not move while it was set by reset time.
- (b) Motor do not move while this time.

(8) Homing accelerating speed/ deceleration speed

- (a) When operates by homing command, it will be accelerate or decelerate by the homing acceleration time and homing deceleration time".
- (b) Available range is 0 ~ 2,147,483,647 [ms].
if it is set by '0', It will be accelerate or decelerate according to acceleration/deceleration time¹ of basic parameter when homing.

(9) Homing dwell time

- (a) This is the time needed to maintain the precise stop accuracy of SERVO motor when using the SERVO motor for positioning.
- (b) Practically, Dwell time is the time needed to remove the residual pulse of deviation counter after completion of positioning and especially Dwell time when returning to the origin is called as "homing dwell time".
- (c) Setting range of Homing dwell time : 0 ~ 65,535(unit: 1ms)

4.6 I/O Signal Parameter

Here describes using input/output signal parameter in embedded positioning.
Input/output signal parameter use to decide active level of input signal.

4.6.1 I/O Signal Parameter

Input/output signal parameter Item	Setting range
High limit signal	0 : A contact(Normaly Open), 1 : B contact(Normaly Close)
Low limit signal	
DOG signal	
Home signal	
Emergency stop signal	
Driver ready signal	
Servo On signal	
Servo alarm reset signal	

4.6.2 Setting Range of I/O Signal Parameter

In case of setting the input signal by A contact, it acts when external is ON and in case of setting by B contact, it acts when external signal is OFF.

- (1) If setting the upper limit signal of input signal parameter by A contact and the lower limit signal by B contact, the upper limit is detected when external upper limit signal is ON while the lower limit is detected when external upper signal is OFF.
- (2) If selecting Emergency stop from External stop selection of extended parameter, the external input signal is used by Emergency stop signal. And if setting Emergency stop signal of input signal parameter by A contact, the positioning module stop immediately when Emergency stop signal is ON. On the contrary, if setting Emergency stop signal of input signal parameter by B contact, the positioning module stop immediately when external Emergency stop signal is OFF.
- (3) If setting the home signal of input signal parameter by A contact, the origin is detected when external home signal is 'Rising edge', while if setting by B contact, the origin is detected when external home signal is 'Falling edge'.

4.7 Common Parameter

Here describes common parameter of embedded positioning.

The parameter which was related with embedded positioning is applied to all of the parameter.

4.7.1 Common parameter

Common Parameter Item		Setting range
Control word	Pulse output level	0: Low Active, 1: High Active
	Encoder pulse input mode.	0:CW/CCW 1 multiplication 1:PULSE/DIR 1 multiplication 2:PHASE A/B 4 multiplication
	Speed override	0: % designate, 1 : Speed designate
	Continous Operation	0: Disable, 1: Enable
Encoder 0 Max. value		-2147483648 ~ 2147283647
Encoder 0 Min. value		

4.7.2 Common Parameter Setting

(1) Encoder pulse input mode

- If you want to use by signal of a manual pulse generator or encoder, can select suitable signal of a manual pulse generator or encoder for using.
- Should select and set one from among CW/CCW 1 multiplier, PULSE/DIR 1 multiplier, PHASE A/B 4 multiplier, as a encoder input signal.
- Set the master axis as encoder at the SSS command when operate motor synchronized with manual pulse generator (MPG). Synchronization rate can take "Encoder \leq Motor" or "Encoder \geq Motor" what you want.

1) CW/CCW 1 multiplier

Counts at the rising edge of A-phase input or B phase input.

Increase count value if B-phase input is Low state at the rising edge of A-phase input and decrease count value if A-phase input is Low state at the rising edge of B-phase input.

Increase/Decrease	Phase A input High	Phase A input Low
Phase B input High	-	Decrease
Phase B input Low	Increase	-

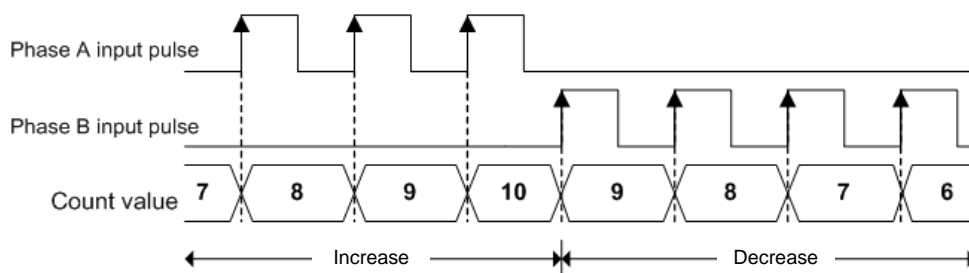

2) PULSE/DIR 1 multiplier

Counts at the rising edge of A-phase input.

Counting direction will be decided by B-phase.

Increase/Decrease	A-phase input pulse rising	A-phase input pulse falling
B-phase input Low	Increase	-
B-phase input High	Decrease	-

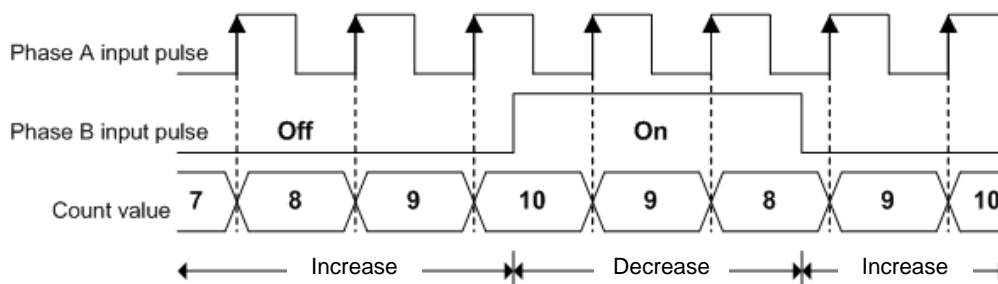

Chapter 4 Positioning Parameter & Operation Data

3) PHASE A/B 4 multiplier

A-phase input pulse and B-phase input pulse count at rising. If A-phase input is antecedent to B-phase input, increasing operation starts, and if B-phase input is antecedent to A-phase input, decreasing operation starts

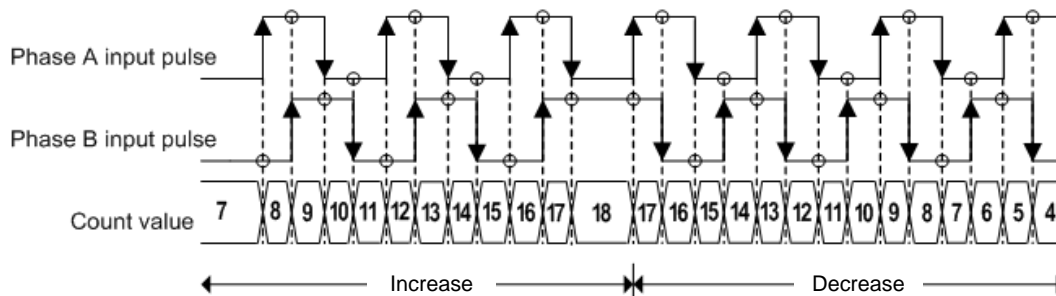

(2) Max/Min value of encoder

(a) When count Inputted pulse (from a manual pulse generator or encoder signal of Servo drive) and display as encoder value, the count range need to be set to Max/Min value of encoder

1) When encoder value increase

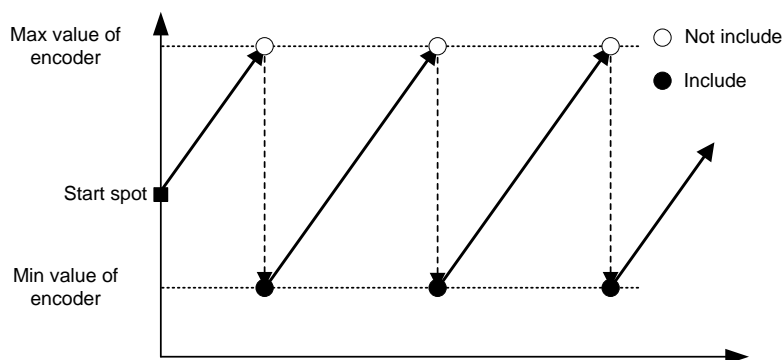

1) When encoder value decrease

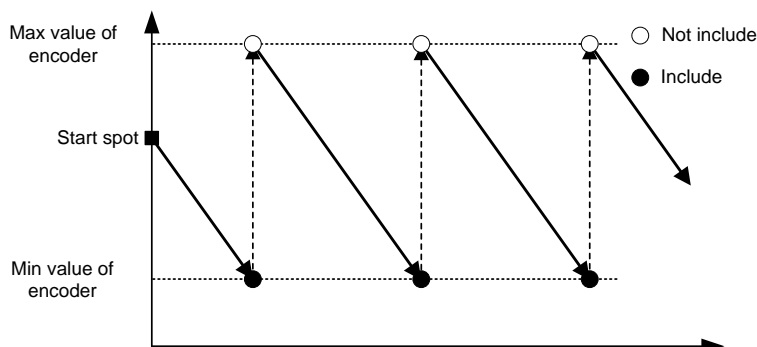

(3) Speed override

(a) When operate changing speed command (Speed override, Positioning speed override, etc), select speed(will be changed) or percentage of goal speed.

(b) In case of setting percentage (%) can set each from 0.01% to 655.35%(unit: 0.01%)

(4) Continuous Operation

(a) The embedded positioning function generate speed profile for each predetermined period.

If continuous operation is disabled, Speed profile will be generated every 1ms and will be generated every 5ms if enabled

(b) if Continuous Operation parameter is disabled, Continuous operation command can not be executed

(Error Code 160 occurs)

(c) The figure below shows example of generated speed profile of trapezoidal acceleration.

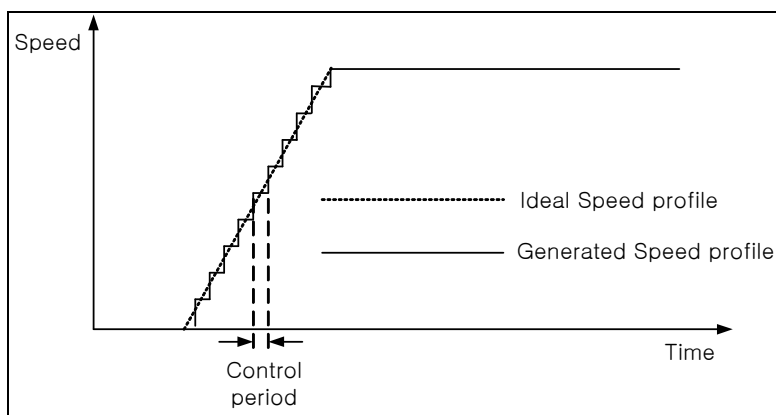

Chapter 4 Positioning Parameter & Operation Data

4.8 Operation Data

Here describes Operation Data of positioning module.

Can set 400 operation data per each axis, operation of circular interpolation and Linear interpolation act in accordance with information of operation data.

4.8.1 Operation Data

Operation data item	Setting range																
Goal position	mm : -2147483648 ~ 2147483647 [X10 ⁻⁴ mm] (-2147483648 ~ 2147483647 [X10 ⁻¹ μm])																
Circular interpolation aux. Position *1	Inch : -2147483648 ~ 2147483647 [X10 ⁻⁵ Inch] degree : -2147483648 ~ 2147483647 [X10 ⁻⁵ degree] pulse : -2147483648 ~ 2147483647 [pulse]																
Operation speed	mm : Bias Speed ~ Speed Limit Inch : Bias Speed ~ Speed Limit degree : Bias Speed ~ Speed Limit pulse : Bias Speed ~ Speed Limit																
Dwell time	0 ~ 65,535[ms]																
M Code no.	0 ~ 65,535																
Setting the axis of ordinates	<table border="1"> <thead> <tr> <th>Bit 7</th> <th>Bit 6</th> <th>Bit 5</th> <th>Bit 4</th> <th>Bit 3</th> <th>Bit 2</th> <th>Bit 1</th> <th>Bit 0</th> </tr> </thead> <tbody> <tr> <td>-</td> <td>-</td> <td>-</td> <td>-</td> <td>축4</td> <td>축3</td> <td>축2</td> <td>축1</td> </tr> </tbody> </table>	Bit 7	Bit 6	Bit 5	Bit 4	Bit 3	Bit 2	Bit 1	Bit 0	-	-	-	-	축4	축3	축2	축1
Bit 7	Bit 6	Bit 5	Bit 4	Bit 3	Bit 2	Bit 1	Bit 0										
-	-	-	-	축4	축3	축2	축1										
Helical interpolation axis	0, 1 axis ~ 4 axis (Set'0',normal circular interpolation)																
The number of circular interpolation turn	0~65,535																
Control Word	Coordinate (bit 0)	0:absolute, 1:incremental															
	Control method (bit 1~3)	0:Single axis positioning, 1: Single axis speed control 2: Single axis Feed control, 3: linear interpolation, 4: Circular interpolation															
	Operation method	0:Singular, 1:Repeat															
	Operation pattern	0:end, 1:Keep, 2: Continuous															
	Circular size (bit 7)	0: Arc <180 1: Arc >=180															
	Acceleration No. (bit 8~9)	0 ~ 3															
	Deceleration No. (bit 10~11)	0 ~ 3															
	Circular interpolation method(bit 12~13)	0:midpoint, 1:center point, 2:radius															
Circular interpolating direction (bit 14)	0:CW, 1:CCW																

Notes

*1 The circular interpolation can not be executed in degree unit. Therefore it is idle to set value at the circular interpolating auxiliary position item.

4.8.2 Operation Data Setting

(1) Step No

- (a) The setting range of positioning data as serial no. is 0 ~ 400.
- (b) The first Starting step of operation data is no.1 step.

Notes

In case of designating step number as '0' with indirect start, Simultaneous start, Position synchronous start, it means current operation step.

(2) Coordinate

- (a) Coordinate of position data includes absolute coordinate and incremental coordinate.

1) Absolute Method

- a) This carries out the positioning control from the current position to the goal position (the goal position assigned by positioning data).
- b) Positioning is carried out based on the assigned position of homing (origin address).
- c) Transfer direction shall be determined by the current position and goal position.
 - ▶ Start position < Goal position : forward direction positioning
 - ▶ Start position > Goal position : reverse direction positioning

[Example]

- When current position : 1000 , Goal position : 8000, forward direction transfer amount is 7000(8000-1000).

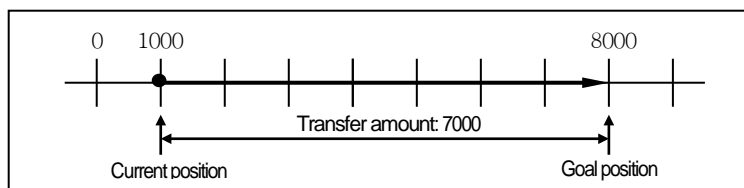
**Notes**

Positioning by Absolute method (Absolute coordinate) can start only in the state that the origin is determined. If starting in the state that the origin is not determined, Error will occur.

2) Incremental method

- a) This carries out the positioning control as much as goal transfer amount from the current position.
- b) Transfer direction shall be determined by the sign of transfer amount..
 - When transfer direction is (+) or no sign : forward direction positioning (position increase direction)
 - When transfer direction is (-) : reverse direction positioning (position decrease direction)

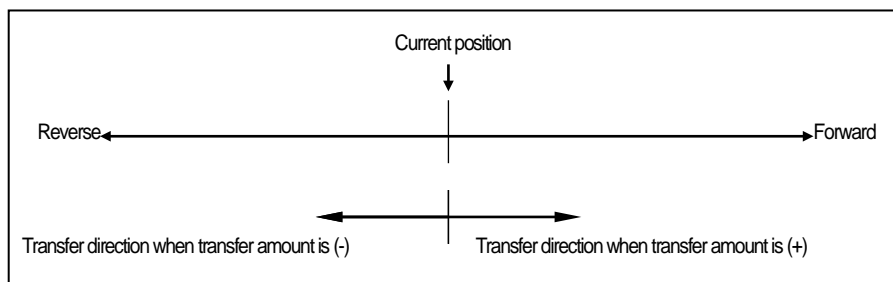

Chapter 4 Positioning Parameter & Operation Data

[Example]

- When current position : 5000 , Goal position : -7000, the positioning shall be done at -2000 position.

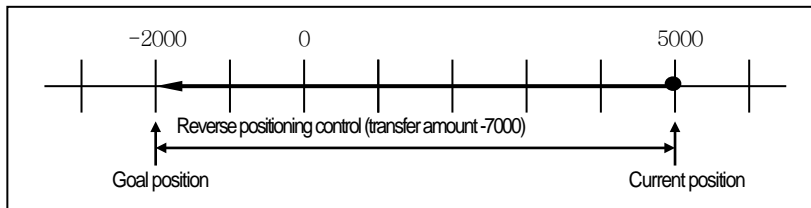

(3) Control Method

- Select the control method: single-axis position control, single-axis Speed control, single-axis Feed control, linear interpolation, circular interpolation.
- For further information, please refer to 8.2 Positioning control of Chapter 8 “Function”.

Notes

Set coordinate and control method in all at the same time in “control method” item with positioning software package. And the software package “Control Method” item is same as follows

Absolute, Single-axis Positioning Control / Absolute, Single-axis Speed Control
 / Absolute, Single-axis FEED control / Absolute, linear Interpolation / Absolute, Circular Interpolation
 / Relative, Single-axis Positioning Control / Relative, Single-axis Speed Control / Relative, Single-axis FEED control
 / Relative, linear Interpolation / Relative, Circular Interpolation

(4) Operation Pattern (End/Keep/Continuous)

- Operation pattern is setting item, how can step of operation data connect with next step and operate.
- Select one operation pattern from End, Keep, Continuous operation.
- For further information, please refer to 8.2.2 operation mode of Positioning control of Chapter 8 “Function”.

(5) Operation Method (Singular/Repeat)

- Operating Method is an option for selecting a operating step after finish operating step from the driving data setting step.
- In case of setting singular, it will be select next step after finish operating settled step. If you set by Repeat, It will be select settled Repeat step after finish operating settled step.
- Select one positioning operation pattern from Singular, Repeat operation.
- For further information, please refer to 8.2.2 operation mode of positioning control of Chapter 8 “Function”.

Notes

Set operation pattern and operation method at the “operation method” item with XG-PM software package. These are “operation method” item;

Singular,End / Singular,Keep / Singular,Continuous / Repeat,End / Repeat,Continuous / Repeat,Continuous.

(6) Goal Position

- This is the area to set the transfer amount of position data as “position value”.
- The setting range is $-2,147,483,648 \sim 2,147,483,647$ [unit]

(7) M Code

- (a) M code is applied to the whole axis in a bundle by M code mode set by positioning parameter and is given to each operation step no. as a Number within the setting range to use at Program.
- (b) The setting range is 1 ~ 65,535
- (c) M code no. can be identified by read by the operation state code
- (d) For further information, please refer to M code output of chapter 4.3.2.

(8) Acceleration/Deceleration No

- (a) The dual acceleration/deceleration time setting is available by setting the acceleration/deceleration time 1/2/3/ 4 of basic parameter as acceleration/deceleration no. 1/2/3/4 respectively.

(9) Operation Speed

- (a) Operation speed is the goal speed which it is applied when it operate positioning
- (b) Operation speed is set within the range that does not exceed Speed limit of basic parameter.

(10) Dwell Time

- (a) This is the waiting time before carrying out the next positioning operation after completing one positioning operation.
- (b) Setting range is 0 ~ 65,535 (ms).
- (c) Especially, in case of using SERVO motor, this is the data to set the waiting time by the stable stop state as positioning module is in the stop state but actual SERVO motor does not reach to the goal position or in transition state.
- (d) While dwell time is active, the corresponding axis of positioning module maintains "ON" of the "Busy Flag" and if dwell time proceeds, "Busy Flag" becomes "OFF" and the positioning end signal becomes "ON".

(11) Setting Axis of ordinates

- (a) This is an option for axis of ordinates of driving shaft when should operate at least over 2 axis such as linear interpolation or circular interpolation.
- (b) Setting each bit from 1 axis to 4 axis. Each bit is as follows

Bit 7	Bit 6	Bit 5	Bit 4	Bit 3	Bit 2	Bit 1	Bit 0
-	-	-	-	Axis 4	Axis 3	Axis 2	Axis 1

- (c) Could choice multiple axes. For example, If choice axis 2 and axis 4 as axis of ordinates, set "000A" by hexadecimal in setting axis of ordinates.

(12) Circular interpolating auxiliary position

- (a) This is an option for setting auxiliary data when the circular interpolation operates.
- (b) According to circular interpolation, mean of circular interpolating auxiliary position is decided.
It means midpoint which is through by circular arc in midpoint method.
It is central point of circular arc in central point method. And It is radius of circular arc in radius method.
- (c) In case that circular interpolation method is radius, be valid only value of circular interpolating auxiliary position of principal axis.
- (d) For further information, please refer to "Circular interpolating control" of 8.2.9 ~ 8.2.11.

(13) Circular interpolating method

- (a) This is an option for method setting from circular interpolating operation.
- (b) There are three method for circular interpolation; midpoint, central point, radius.
- (c) For further information, please refer to "Circular interpolation control" of 8.2.9 ~ 8.2.11.

(14) Circular interpolating direction

- (a) This is an option for setting direction of drawing circle from circular interpolating operation when the operation starts.
- (b) Circular interpolation direction is based on drawing circular interpolation when the principal axis is axis 'X' and the axis of ordinates is axis 'Y'.
- (c) This option is ignored from circular interpolation of midpoint because circular interpolating direction is selected by position of midpoint.
- (d) For further information, please refer to circular interpolation of 8.2.9 ~ 8.2.11.

(15) Circular arc size

- (a) When circular interpolating method is set by radius method, User can select one of 2 circular arcs.
- (b) Select one of over the 180-degree circular interpolation or under the 180-degree circular interpolation.
- (c) This option is ignored in the circular interpolation of midpoint method and central point method.
- (d) For further information, please refer to designating radius circular interpolation of 8.2.11

Notes

Positioning software package set as follows at a time;

- circular arc method, circular interpolating direction, circular arc size with 'Circular interpolating mode'.

Software package 'Circular interpolating mode' is as follows ;

- Midpoint / Central point, CW / Central point, CCW / Radius, CW, Circular arc < 180-degree / Radius , CW ,
Circular arc >= 180-degree / Radius, CCW, Circular arc < 180-degree / Radius, CCW, Circular arc >= 180-degree

(16) The number of circular interpolating turn

- (a) This is an option setting the number of rotation of circular arc when operating over the 360-degree.
- (b) Setting range is 1 ~ 65,535.

(17) Helical interpolation axis

- (a) It is item which is setting axis for linear operation in operating helical interpolation.
- (b) Settled axis from helical interpolation rectilinearly operates to settled position at the goal position.
- (c) For further information, please refer to helical interpolating control of 8.2.12.

Chapter 4 Positioning Parameter & Operation Data

Chapter 5 Internal Memory and I/O Signal

5.1 Internal Memory

Here describes the internal memory used for positioning module if XGB Main unit

Internal memory is used when executing direct Data read/write between positioning module and PLC CPU by using PUP(PUTP), GET(GETP) command instead of using the dedicated command. For Data read/write using the dedicated command, please refer to 6.2 Dedicated Command

5.1.1 Step Data during Point Start

(1) Memory Address of POINT Start Step Data

Memory Address				Description
1 axis	2 axis	3 axis	4 axis	
1A1	221	2A1	321	Point Operation Step 1
1A2	222	2A2	322	Point Operation Step 2
1A3	223	2A3	323	Point Operation Step 3
1A4	224	2A4	324	Point Operation Step 4
1A5	225	2A5	325	Point Operation Step 5
1A6	226	2A6	326	Point Operation Step 6
1A7	227	2A7	327	Point Operation Step 7
1A8	228	2A8	328	Point Operation Step 8
1A9	229	2A9	329	Point Operation Step 9
1AA	22A	2AA	32A	Point Operation Step 10
1AB	22B	2AB	32B	Point Operation Step 11
1AC	22C	2AC	32C	Point Operation Step 12
1AD	22D	2AD	32D	Point Operation Step 13
1AE	22E	2AE	32E	Point Operation Step 14
1AF	22F	2AF	32F	Point Operation Step 15
1B0	230	2B0	330	Point Operation Step 16
1B1	231	2B1	331	Point Operation Step 17
1B2	232	2B2	332	Point Operation Step 18
1B3	233	2B3	333	Point Operation Step 19
1B4	234	2B4	334	Point Operation Step 20

(2) POINT Start Step Data Setting

- The POINT start step data setting command for POINT start e during POINT operation is XPWR.
- References for XPST (command of XGK point operating) and XPWR (command of point operating step data setting) are on 'Chapter 6.3.45'.
- In PLC program, POINT operation data setting during POINT operation should be done in the step before POINT operation command is executed for normal action of POINT operation.

5.1.2 Teaching Data

(1) Memory Address of Teaching Data

Memory Address				Description
1 axis	2 axis	3 axis	4 axis	
180	200	280	300	Teaching Data1(LOWER)
181	201	281	301	Teaching Data1(UPPER)
182	202	282	302	Teaching Data2(LOWER)
183	203	283	303	Teaching Data2(UPPER)
184	204	284	304	Teaching Data3(LOWER)
185	205	285	305	Teaching Data3(UPPER)
186	206	286	306	Teaching Data4(LOWER)
187	207	287	307	Teaching Data4(UPPER)
188	208	288	308	Teaching Data5(LOWER)
189	209	289	309	Teaching Data5(UPPER)
18A	20A	28A	30A	Teaching Data6(LOWER)
18B	20B	28B	30B	Teaching Data6(UPPER)
18C	20C	28C	30C	Teaching Data7(LOWER)
18D	20D	28D	30D	Teaching Data7(UPPER)
18E	20E	28E	30E	Teaching Data8(LOWER)
18F	20F	28F	30F	Teaching Data8(UPPER)
190	210	290	310	Teaching Data9(LOWER)
191	211	291	311	Teaching Data9(UPPER)
192	212	292	312	Teaching Data10(LOWER)
193	213	293	313	Teaching Data10(UPPER)
194	214	294	314	Teaching Data11(LOWER)
195	215	295	315	Teaching Data11(UPPER)
196	216	296	316	Teaching Data12(LOWER)
197	217	297	317	Teaching Data12(UPPER)
198	218	298	318	Teaching Data13(LOWER)
199	219	299	319	Teaching Data13(UPPER)
19A	21A	29A	31A	Teaching Data14(LOWER)
19B	21B	29B	31B	Teaching Data14(UPPER)
19C	21C	29C	31C	Teaching Data15(LOWER)
19D	21D	29D	31D	Teaching Data15(UPPER)
19E	21E	29E	31E	Teaching Data16(LOWER)
19F	21F	29F	31F	Teaching Data16(UPPER)

(2) Setting

- The command of Teaching data setting is XTWR.
- References for XTEAA (command of Teaching) and XTWR (command of Teaching Data Setting) are on 'Chapter 6.3.30'.
- In PLC program, in order to carry out the normal action of Teaching command, the Teaching data setting should be done in the step before Teaching command is executed.

5.1.3 Step Data of Simultaneous Start

(1) Step Data of Simultaneous Start Memory Address

Memory Address				Description
1 axis	2 axis	3 axis	4 axis	
1B6	236	2B6	336	Simultaneous Start 1axis Step Number
1B7	237	2B7	337	Simultaneous Start 2axis Step Number
1B8	238	2B8	338	Simultaneous Start 3axis Step Number
1B9	239	2B9	339	Simultaneous Start 4axis Step Number

(2) Setting

- (a) The command for Step Data of Simultaneous Start setting is XSWR.
- (b) References for XSST (command of Simultaneous Start) and XSWR (Setting command for Step Data of Simultaneous Start) are on 'Chapter 6.3.6.
- (c) In PLC program, in order to carry out the normal action of Simultaneous Start, the Step data setting of Simultaneous Start should be done in the step before Simultaneous Start command is executed.

5.1.4 Status Information

(1) Memory Address of Status Information

XSRD Command Device Offset	Memory Address				Description
	1 axis	1 axis	1 axis	1 axis	
0	1C0	240	2C0	340	Operation state bit information (Lower)
1	1C1	241	2C1	341	Operation state bit information (Upper)
2	1C2	242	2C2	342	Axis information
3	1C3	243	2C3	343	External I/O signal state
4	1C4	244	2C4	344	Current Position (LOWER)
5	1C5	245	2C5	345	Current Position (UPPER)
6	1C6	246	2C6	346	Current Speed (LOWER)
7	1C7	247	2C7	347	Current Speed (UPPER)
8	1C8	248	2C8	348	Step Number
9	1C9	249	2C9	349	M Code Number
10	1CA	24A	2CA	34A	Current error information
11	1CB	24B	2CB	34B	Error information 1
12	1CC	24C	2CC	34C	Error information 2
13	1CD	24D	2CD	34D	Error information 3
14	1CE	24E	2CE	34E	Error information 4
15	1CF	24F	2CF	34F	Error information 5
16	1D0	250	2D0	350	Error information 6
17	1D1	251	2D1	351	Error information 7
18	1D2	252	2D2	352	Error information 8
19	1D3	253	2D3	353	Error information 9
20	1D4	254	2D4	354	Error information 10
21	1D5	255	2D5	355	Encoder Value (LOWER)
22	1D6	256	2D6	356	Encoder Value (UPPER)

(2) Setting

- (a) The area of state information of internal memory is the Read only area. Thus, it is available to use only by GET, GETP command. (PUT, PUTP command is not allowed to use in this area).
- (b) The command of State Information ready only is XSRD.
- (c) If you use only command XSRD, the information of axis status is read at the same time.
- (d) If you want to choose to read among the state information, it is available to read memory address of above table using by GET/GETP

Chapter 5 Internal Memory and I/O Signal

(e) Status Information details

1) Operation State Bit Information (Lower)

Memory Address				Information
1 axis	2 axis	3 axis	4 axis	
1C0	240	2C0	340	Operation State bit Information (LOWER)

Bit 0	In Operation	[0: Stop, 1: In Operation]
Bit 1	Error	[0: No Error, 1: Error]
Bit 2	Positioning Completed	[0: Not Completed, 1: Completed]
Bit 3	M Code signal	[0: M Code Off, 1: M Code On]
Bit 4	Homing State	[0: Not Fixed, 1: Fixed]
Bit 5	N/A	
Bit 6	Stop State	[0: Not stop state by stop command, 1: stop state by stop command]
Bit 7	Variable Data Read/Write	[0: Variable Data access finished, 1: Variable Data access is ongoing]
Bit 8	Upper Limit Detection	[0: No Detection, 1: Detection]
Bit 9	Lower Limit Detection	[0: No Detection, 1: Detection]
Bit 10	Emergency Stop State	[0: Normal, 1: Emergency Stop]
Bit 11	Direction	[0: Forward, 1: Reverse]
Bit 12	Acceleration State	[0: Not Accelerating, 1: Accelerating]
Bit 13	Constant Speed State	[0: Not Constant Speed, 1: Constant Speed]
Bit 14	Deceleration State	[0: Not Decelerating, 1: Decelerating]
Bit 15	Dwell State	[0: No Dwelling, 1: Dwelling]

2) Operation State Bit Information (Upper)

Memory Address				Information
1 axis	2 axis	3 axis	4 axis	
1C1	241	2C1	341	Operation State Bit Information (UPPER)

Bit 0	Axis 1 Position Controlling	[0: Axis 1 Position not in control, 1: Axis 1 Position in control]
Bit 1	Axis1 Speed Controlling	[0: Axis 1 Speed not in control, 1: Axis 1 Speed in control]
Bit 2	Linear Interpolation in Operation	[0: Linear Interpolation not in Operation, 1: Linear Interpolation in Operation]
Bit 3	No Use	
Bit 4	Circular Interpolation in Operation	[0: Circular Interpolation not in Operation, 1: Circular Interpolation in Operation]
Bit 5	Homing Operating	[0: Homing not in Operation, 1: Homing in Operation]
Bit 6	Synchronous Start by Position in Operation	[0: Synchronous Start by position not in Operation, 1: Synchronous Start by position in Operation]
Bit 7	Synchronous Start by Speed in Operation	[0: Synchronous Start by Speed not in Operation, 1: Synchronous Start by Speed in Operation]
Bit 8	JOG in Operation	[0: JOG not in Operation, 1: JOG in Operation]
Bit 9	No Use	
Bit 10	Inching in Operation	[0: Inching not in Operation, 1: Inching in Operation]
Bit 11	No Use	
Bit 12	RTP ^{*1} in Operation	[0: RTP not in Operation, 1: RTP in Operation]
Bit 13	CAM in Operation	[0: CAM not in Operation, 1: CAM in Operation]
Bit 14	FEED in Operation	[0: FEED not in Operation, 1: FEED in Operation]
Bit 15	Circular Interpolation in Operation	[0: Circular Interpolation not in Operation, 1: Circular Interpolation in Operation]

Note

*1 RTP: Return to Position Before Manual Operation

3) Axis Information

Memory Address				Information
1 axis	2 axis	3 axis	4 axis	
102	242	202	342	Axis Information

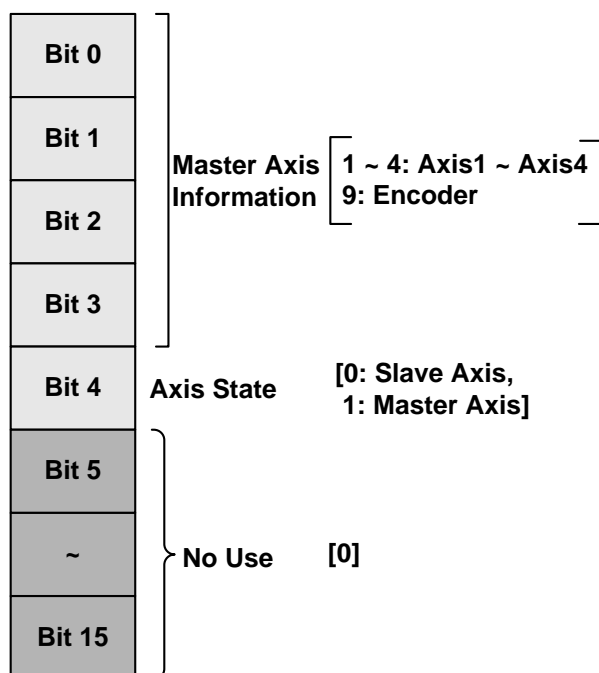

4) External I/O Signal State

Memory Address				Information
1 axis	2 axis	3 axis	4 axis	
1C3	243	2C3	343	External I/O Signal State

Bit 0	External Emergency/ ^{*1} Deceleration Stop Signal	[0: External Emergency Stop/Deceleration Stop Signal OFF, 1: External Emergency Stop/Deceleration Stop ON]
Bit 1		
Bit 2	No Use	[0]
Bit 3		
Bit 4	Upper Limit Signal	[0: External Upper Limit OFF, 1: External Upper Limit ON]
Bit 5	Lower Limit Signal	[0: External Lower Limit OFF, 1: External Lower Limit ON]
Bit 6	Home Signal	[0: Home Signal OFF, 1: Home Signal ON]
Bit 7	DOG Signal	[0: DOG Signal OFF, 1: DOG Signal ON]
Bit 8	No Use	[0]
Bit 9		
Bit 10		
Bit 11	Drive Ready Signal	[0: Drive Ready Signal OFF, 1: Drive Ready Signal ON]
Bit 12	Servo On Signal	[0: Servo Off, 1: Servo On]
Bit 13	Servo Alarm Reset Signal ^{*2}	[0: Alarm Reset Off, 1: Alarm Reset On]
Bit 14	No Use	[0]
Bit 15		

Notes

*1 : External emergency stop / deceleration stop signal: It operates either 'Emergency stop' or 'Deceleration stop' according to selection of expanded parameter setting between 'Emergency stop / deceleration stop'

*2 : Alarm reset signal keeps the ON state during only the time set in the extended parameter.

Chapter 5 Internal Memory and I/O Signal

5.2 I/O Signal

Here describes the contents and functions of I/O signal for the exchange of data between Positioning module and XGB CPU.

5.2.1 Contents of I/O Signal

- (1) I/O signal of positioning module uses input: 16 bits and output: 16 bits.
- (2) Embedded Positioning ready signal (U01.00.F) becomes "ON" only when Modules are in normal state in H/W and it always keeps "ON" regardless of PLC operation mode.
- (3) Output Signal

This is the signal which transfers to positioning module from PLC CPU.

Signal Direction: PLC CPU → Positioning		
Axis	Input Signal	Description
1 axis	Uxx.01.0	1 axis forward direction Jog
	Uxx.01.1	1 axis reverse direction Jog
	Uxx.01.2	1 axis Jog high/low speed
	Uxx.01.3	No use
2 axis	Uxx.01.4	2 axis forward direction Jog
	Uxx.01.5	2 axis reverse direction Jog
	Uxx.01.6	2 axis Jog high/low speed
	Uxx.01.7	No use
3 axis	Uxx.01.8	3 axis forward direction Jog
	Uxx.01.9	3 axis reverse direction Jog
	Uxx.01.A	3 axis Jog high/low speed
	Uxx.01.B	No use
4 axis	Uxx.01.C	4 axis forward direction Jog
	Uxx.01.D	4 axis reverse direction Jog
	Uxx.01.E	4 axis Jog high/low speed
	Uxx.01.F	No use

(4) Input Signal

This is the Signal which transfers to PLC CPU from Positioning.

Axis	Signal Direction: PLC CPU □ Positioning Module	
	Input Signal	Description
-	Uxx.00.0	No use
-	Uxx.00.1	No use
-	Uxx.00.2	No use
-	Uxx.00.3	No use
-	Uxx.00.4	No use
-	Uxx.00.5	No use
-	Uxx.00.6	No use
-	Uxx.00.7	No use
-	Uxx.00.8	No use
-	Uxx.00.9	No use
-	Uxx.00.A	No use
-	Uxx.00.B	No use
-	Uxx.00.C	No use
-	Uxx.00.D	No use
Common	Uxx.00.E	Flash Memory writing
Common	UXX.00.F	Positioning Module ready

Chapter 5 Internal Memory and I/O Signal

5.2.2 Usage of I/O Signal

(1) JOG Operation

- (a) Forward/Reverse Jog Signals show the direction of Jog Operation. The Jog operation shall be divided into Forward/Reverse direction according to the On/Off signals. When Forward Jog Signal is On, it starts Forward Operation and When Jog Signal is Off, it starts Reverse Operation. When both signals Off, it stops Jog Signals. When both signals On, it does Forward Jog Signal.

Forward Jog Signal	Reverse Jog Signal	Jog Operation Status
On	Off	Forward Jog Operation
Off	On	Reverse Jog Operation
Off	Off	Stop
On	On	Forward Jog Operation

- (b) If Jog direction is changed during Jog operation, it slows down at first and then operates as the direction it changed.
- (c) According to value of Jog low/high Signals, it could operate with low/high speed. When jog low/high signals Off, it operates with low speed and when they are ON, it operates with high speed.
- (d) If you change value of low/high jog signals during Jog operation, there will be no stop and apply the speed as you changed.

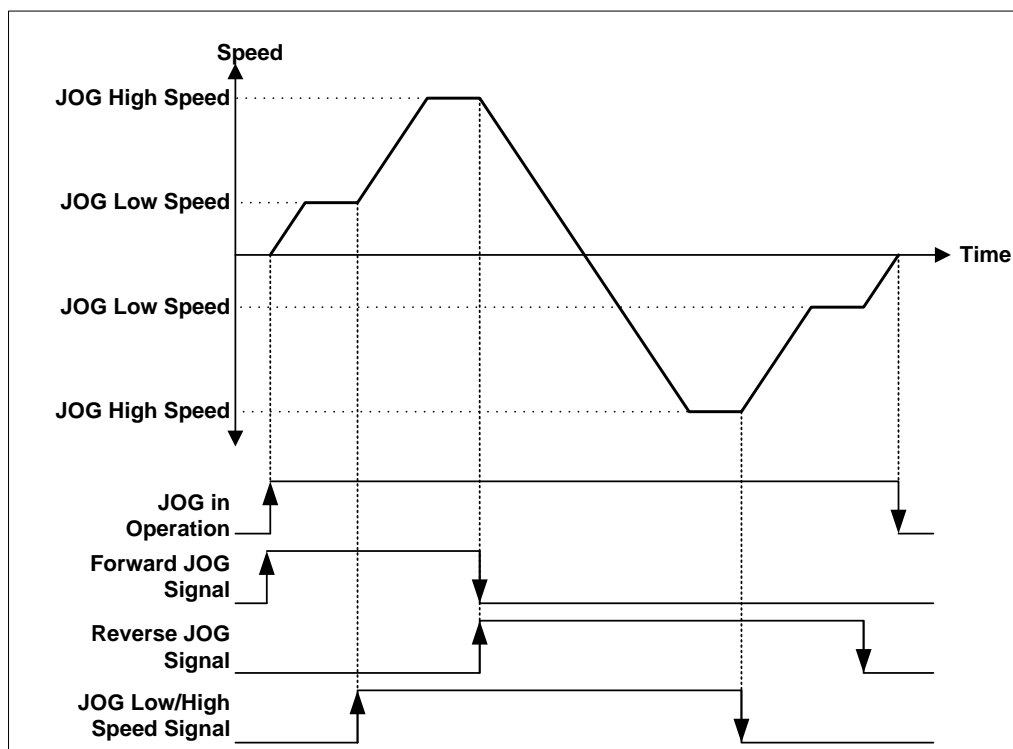

Chapter 5 Internal Memory and I/O Signal

Chap.6 Function block

It describes the function blocks used for the high-performance XGB embedded positioning.

6.1 Common items of function blocks

The common I/O variables used for the positioning function blocks are as follows.

I/O	Variable Name	Data type	Details
Input	REQ	BOOL	Request for executing function blocks -If the conditions connected to this area are established during executing the program and it leads to "0→1"(edge or level), function blocks will run.
	BASE	USINT	Base position No. - The area is used to set up the numbers of the bases where positioning modules are equipped. - Embedded positioning base No.: 0(Fixed)
	SLOT	USINT	Embedded positioning slot - The area is used to set up the numbers of slots where positioning modules are equipped. - Embedded positioning slot No.: 1(Fixed)
	AXIS	USINT	Used axis No. - 1 ~ 4: 1 axis ~ 4 axis - If the values other than set ones are selected, "error6" will occur.
Output	DONE	BOOL	Displaying the status that the execution of function blocks is completed. -When the function block is completed without error, "1" will be output and maintained until next execution; If error occurs, "0" will be output.
	STAT	UINT	Displaying error state - The area outputs the error No. when errors occur during executing function blocks.

(1) The errors that occur in STAT variables of the positioning function blocks are as follows.

STAT	Details	Description
0	Normal	If function blocks are normally executed, DONE=1, STAT=0 will be output.
1	Base No. setting error	It occurs when the base No.(BASE)'s set values are out of the range.
3	Slot No. setting error	It occurs when the slot No.(SLOT)'s set values are out of the range(1 ~ 11).
4	Empty slot error	It occurs when the module is not installed in the position that is specified as BASE, SLOT.
5	Mismatch of positioning modules	It occurs when other modules are installed instead of the positioning modules in the position that is specified as BASE, SLOT.
6	Axis No. error	It occurs when the axis No.(AXIS)'s set values are out of the range(1 ~ 4).
10	Overlapping execution error of function blocks	It occurs when the previous function block that was executed prior to the current one has not yet read by the positioning module. After the previously executed function block is read by the positioning module, execute the other function block. It takes maximum 10ms for the positioning module to read the function block after execution.
11	Input variables setting error	It occurs when the set values of variables are out of the range except BASE, SLOT, AXIS. Check the range of settable values for the variables in each function block.
101 ~ 811	Positioning module error	The error occurs from the positioning module as a result of executing function blocks.

(2) The setting ranges of the position and speed of the positioning function blocks are as follows. In this manual, pulse and speed are based on the unit of pulse/sec.

Area	Setting unit	Setting range
Position	pulse	-2,147,483,648 ~ 2,147,483,647[pulse]
	mm	-2,147,483,648 ~ 2,147,483,647[x 10 ⁻⁴ mm]
	inch	-2,147,483,648 ~ 2,147,483,647[x 10 ⁻⁵ inch]
	degree	-2,147,483,648 ~ 2,147,483,647[x 10 ⁻⁵ degree]
Speed	pulse/second	1 ~ 2,000,000 [pulse/second]
	mm/minute	1 ~ 2,147,483,647 [X10 ⁻² mm/minute]
	inch/minute	1 ~ 2,147,483,647 [X10 ⁻³ Inch/minute]
	degree/minute	1 ~ 2,147,483,647 [X10 ⁻³ degree/minute]

(3)For the type and size of the data mainly used for the positioning function blocks, refer to the below table.

No.	Reserved word	Data type	Size(Bit)	Range
1	BOOL	Boolean	1	0, 1
2	SINT	Short Integer	8	-128 ~ 127
3	USINT	Unsigned Short Integer	8	0 ~ 255
4	INT	Integer	16	-32768 ~ 32767
5	UINT	Unsigned Integer	16	0 ~ 65535
6	DINT	Double Integer	32	-2147483648 ~ 2147483647
7	UDINT	Unsigned Double Integer	32	0 ~ 4294967295

Chapter 6 Function block

6.2 positioning module function block

No.	Name	Description	Operating conditions	Refer to
1	XPM_ORG	Homing start-up	Edge	6.5.1
2	XPM_FLT	Floating origin point setup	Edge	6.10.1
3	XPM_DST	Direct start-up	Edge	6.5.2
4	XPM_IST	Indirect start-up	Edge	6.5.3
5	XPM_SST	Simultaneous start-up	Edge	6.5.5
6	XPM_VTP	Speed/position control switching	Edge	6.8.5
7	XPM_VTPP	Positioning speed/position control switching	Edge	6.8.6
8	XPM_PTV	Position/speed control switching	Edge	6.8.4
9	XPM_STP	Deceleration Stop	Edge	6.5.7
10	XPM_SKP	Skip operation	Edge	6.8.7
11	XPM_SSP	Position synchronization	Edge	6.7.1
12	XPM_SSS	Speed synchronization	Edge	6.7.2
13	XPM_SSSP	Positioning speed synchronization	Edge	6.7.3
14	XPM_POR	Position override	Edge	6.8.1
15	XPM_SOR	Speed override	Edge	6.8.2
16	XPM_PSO	Position speed override	Edge	6.8.3
17	XPM_NMV	Continuous operation	Edge	6.8.8
18	XPM_INC	Inching start-up	Edge	6.6.2
19	XPM_RTP	Returning to the position of pre-manual operation	Edge	6.6.3
20	XPM_SNS	Designation of start-up step No.	Edge	6.8.9
21	XPM_SRS	Specifying the start step during repetitive operation	Edge	6.8.10
22	XPM_MOF	M code Off	Edge	6.10.2
23	XPM_PRS	Current position preset	Edge	6.8.11
24	XPM_EPRES	Presetting encoder values	Edge	6.8.12
25	XPM_ATEA	Position/speed teaching(ROM, RAM) (Array type)	Edge	6.4.8
26	XPM_SBP	Basic parameters teaching	Edge	6.4.1
27	XPM_SEP	Extended parameters teaching	Edge	6.4.2
28	XPM_SHP	Homing parameters teaching	Edge	6.4.3
29	XPM_SMP	Manual operation parameters teaching	Edge	6.4.4
30	XPM_SIP	External I/O signal parameters teaching	Edge	6.4.5
31	XPM_SCP	Common parameters teaching	Edge	6.4.6
32	XPM_SMD	Operating data teaching	Edge	6.4.7
33	XPM_VRD	Reading variable data	Edge	6.4.9
34	XPM_VWR	Writing variable data	Edge	6.4.10
35	XPM_EMG	Emergency Stop	Edge	6.5.8
36	XPM_RST	Error reset	Edge	6.9.1
37	XPM_HRST	Error history reset	Edge	6.9.2
38	XPM_PST	Point operation start-up	Edge	6.5.6
39	XPM_WRT	Saving parameters/operating data	Edge	6.4.11
40	XPM_CRD	Reading operation state code information	Level	6.3.1
41	XPM_SRD	Reading operation state bit information	Level	6.3.2
42	XPM_ENCRD	Reading encoder values	Level	6.3.3
43	XPM_JOG	JOG start-up	Level	6.6.1
44	XPM_CAM	CAM start-up	Edge	6.7.4
45	XPM_CAMO	Start-up of CAM specifying major axis offset	Edge	6.7.5
46	XPM_ELIN	Ellipse interpolation operation	Edge	6.5.4
47	XPM_RSTR	Restart-up	Edge	6.5.9
48	XPM_SVON	Servo-On	Edge	6.11.1
49	XPM_SVOFF	Servo-Off	Edge	6.11.2
50	XPM_SRST	Servo error reset	Edge	6.11.3

Notice

1. Dedicated commands for the embedded positioning can be divided into; the command that works on the rising edge, namely, when input conditions are “On”, it performs operations only once. To perform operations again, input conditions should be “Off” and then, “On”; the command that works at a high level, namely, it keeps performing operations while input conditions are “On” and when input conditions are “Off”, it does not work.

Notice

▷ With the exception of XPM_SRD, XPM_CRD, XPM_ENCRD, the only one positioning function block should be executed for the axis within a single scan. If you use the program as the below example, the function block will not work properly.

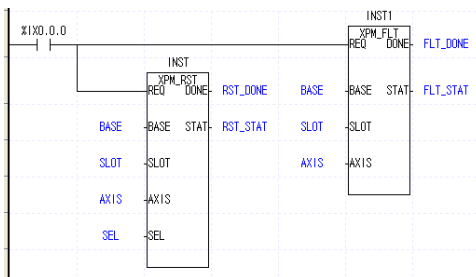
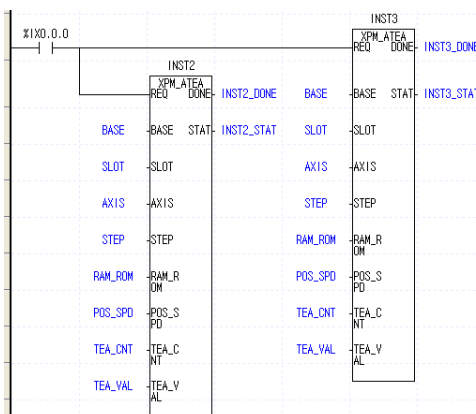
When executing different function blocks**When executing the same function blocks**

▷ For the different axes, you can simultaneously execute the same function blocks.

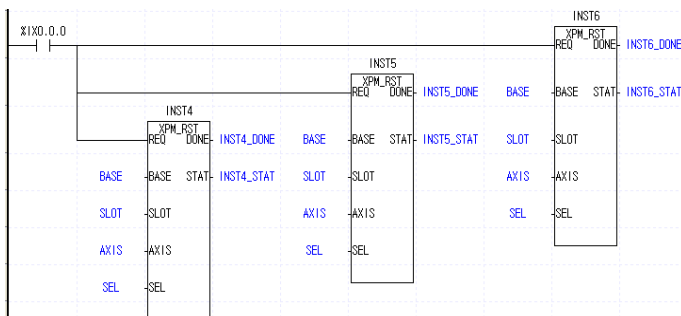

However, in the case of XPM_VRD, you cannot simultaneously execute function blocks within a single scan not only for the same axes but also for different ones. If you execute the XPM_VRD commands at the same time in one scan, the error code 811 will occur and XPM_VRD will not work after the first XPM_VRD.

6.3 Function blocks related to reading module information

6.3.1 Reading operating data (XPM_CRD)

Function Block Type	Details
<pre> graph LR subgraph XPM_CRD REQ[REQ] BASE[BASE] SLOT[SLOT] AXIS[AXIS] DONE[DONE] STAT[STAT] ERR[ERR] CERR[CERR] CA[CA] CV[CV] SA[SA] SV[SV] TRQ[TRQ] STEP[STEP] MCD[MCD] end REQ --- BREQ[BOOL] BASE --- BBASE[USINT] SLOT --- BSLOT[USINT] AXIS --- BAXIS[USINT] DONE --- BDONE[BOOL] STAT --- BSTAT[UINT] ERR --- BERR[UINT] CERR --- BCERR[UINT] CA --- BCA[DINT] CV --- BCV[DINT] SA --- BSA[DINT] SV --- BSV[DINT] TRQ --- BTRQ[INT] STEP --- BSTEP[UINT] MCD --- BMCD[UINT] </pre>	<p>Input</p> <p>REQ : Request for executing function blocks BASE : Setting up the numbers of the bases where modules are equipped SLOT : Setting up the numbers of slots where modules are equipped AXIS : Specifying the axis to give commands 1 ~ 4: 1axis ~ 4axis</p> <p>Output</p> <p>DONE : Keeping 1 after the initial operation STAT : Outputting error No. that occurred during executing function blocks ERR : Displaying axis error CERR : Displaying common error CA : Displaying command position CV : Displaying command speed SA : Displaying the current position SV : Displaying the current speed TRQ : Displaying the current torque STEP : Displaying the current operating data step No. MCD : Displaying the current M code value</p>

- (1) The current operating state of the specified axis is read in the AXIS of the embedded positioning.
- (2) The read operating data is saved to the variables set in the output of function blocks.
- (3) In AXIS, you can set up the axis to command and select one among 1~4(1axis~4axis).
If the values other than set ones are selected, "error6" will occur.
- (4) You can read and monitor the command position, command speed, current position, current speed, torque, operating data No., M code values of the set axis or use them as conditions for the user program. (In the case of XECU embedded positioning, there is no torque data)
- (5) "-" speed of the command speed(CV) or the current speed(SV) indicates the reverse direction.
- (6) XECU embedded positioning is the pulse output type; the current position and the current speed indicate the same values with the command position, command speed.
- (7) TRQ indicates the current Servo Drive's torque state and XECU embedded positioning that is the pulse output type is displayed as 0.

6.3.2 Reading bit information of the current operating status (XPM_SRD)

Function Block Type	Details																		
<div style="text-align: center; border: 1px solid black; padding: 10px; width: fit-content; margin: auto;"> <p>XPM_SRD</p> <table style="width: 100%; border-collapse: collapse;"> <tr> <td style="width: 50%; text-align: right;">BOOL — REQ</td> <td style="width: 50%; text-align: left;">DONE — BOOL</td> </tr> <tr> <td style="text-align: right;">USINT — BASE</td> <td style="text-align: left;">STAT — UINT</td> </tr> <tr> <td style="text-align: right;">USINT — SLOT</td> <td style="text-align: left;">ST1 — BOOL[8]</td> </tr> <tr> <td style="text-align: right;">USINT — AXIS</td> <td style="text-align: left;">ST2 — BOOL[8]</td> </tr> <tr> <td></td> <td style="text-align: left;">ST3 — BOOL[8]</td> </tr> <tr> <td></td> <td style="text-align: left;">ST4 — BOOL[8]</td> </tr> <tr> <td></td> <td style="text-align: left;">ST5 — BOOL[8]</td> </tr> <tr> <td></td> <td style="text-align: left;">ST6 — BOOL[8]</td> </tr> <tr> <td></td> <td style="text-align: left;">ST7 — BOOL[8]</td> </tr> </table> </div>	BOOL — REQ	DONE — BOOL	USINT — BASE	STAT — UINT	USINT — SLOT	ST1 — BOOL[8]	USINT — AXIS	ST2 — BOOL[8]		ST3 — BOOL[8]		ST4 — BOOL[8]		ST5 — BOOL[8]		ST6 — BOOL[8]		ST7 — BOOL[8]	<p>Input</p> <p>REQ : Request for executing function blocks</p> <p>BASE : Setting up the numbers of the bases where modules are equipped</p> <p>SLOT : Setting up the numbers of slots where modules are equipped</p> <p>AXIS : Specifying the axis to give commands 1 ~ 4: 1axis ~ 4axis</p> <p>Output</p> <p>DONE : Keeping 1 after the initial operation</p> <p>STAT : Outputting error No. that occurred during executing function blocks</p> <p>ST1 : State 1</p> <p>ST2 : State 2</p> <p>ST3 : State 3</p> <p>ST4 : State 4</p> <p>ST5 : State 5</p> <p>ST6 : State 6</p> <p>ST7 : State 7</p>
BOOL — REQ	DONE — BOOL																		
USINT — BASE	STAT — UINT																		
USINT — SLOT	ST1 — BOOL[8]																		
USINT — AXIS	ST2 — BOOL[8]																		
	ST3 — BOOL[8]																		
	ST4 — BOOL[8]																		
	ST5 — BOOL[8]																		
	ST6 — BOOL[8]																		
	ST7 — BOOL[8]																		

- (1) The command to read the bit information of the current operating state of the specified axis is sent to the AXIS of the embedded positioning.
- (2) The read bit information of the current operating state is saved to the variables set in ST1 ~ ST7
- (3) In AXIS, you can set up the axis to command and select one among 1~4.
If the values other than set ones are selected, "error6" will occur.
- (4) The details of output variables ST1 ~ ST7 of the function block to read the current operating state bit can be used for the program.

Chapter 6 Function block

	Bit	Description	Bit	Description
ST1	[0]	During operation(0:Stop, 1:BUSY)	[4]	Origin determination state(0:undetermined, 1:determined)
	[1]	Error state	[5]	-
	[2]	Completion of positioning	[6]	Stop state
	[3]	M code On signal(0:Off, 1:On)	[7]	-
ST2	[0]	Detection of the external upper limit	[4]	During acceleration
	[1]	Detection of the external lower limit	[5]	At constant speed
	[2]	Emergency Stop state	[6]	During deceleration
	[3]	Direction(0:forward, 1:reverse)	[7]	During dwell
ST3	[0]	During 1 axis position control	[4]	During circular interpolation operation
	[1]	During 1 axis speed control	[5]	During homing operation
	[2]	During linear interpolation operation	[6]	During position synchronous operation
	[3]	-	[7]	During speed synchronous operation
ST4	[0]	During JOG operation	[4]	In the process of returning to the position of pre-manual operation
	[1]	-	[5]	During CAM control operation
	[2]	During inching operation	[6]	During feed control operation
	[3]	-	[7]	During ellipse interpolation operation

	Bit	Description	Bit	Description
ST5	[0]	Major axis data 1 ~ 4: 1axis ~ 4axis 9: encoder	[4]	Axis state(0:minor axis, 1: major axis)
	[1]		[5]	-
	[2]		[6]	-
	[3]		[7]	Flash Busy
ST6	[0]	Emergency Stop/deceleration Stop signal	[4]	External upper limit signal
	[1]	-	[5]	External lower limit signal
	[2]	-	[6]	Origin signal
	[3]	-	[7]	Approximate origin signal
ST7	[0]	-	[4]	Servo On output signal
	[1]	-	[5]	Servo alarm reset signal
	[2]	-	[6]	-
	[3]	Drive ready signal	[7]	-

6.3.3 Reading encoder values (XPM_ENCRD)

Function Block Type	Details
<div style="text-align: center;"> <p>The diagram shows a central box labeled 'XPM_ENCRD'. On the left side, there are four inputs: 'REQ' (connected to a 'BOOL' label), 'BASE' (connected to a 'USINT' label), 'SLOT' (connected to a 'USINT' label), and 'ENC' (connected to a 'BOOL' label). On the right side, there are three outputs: 'DONE' (connected to a 'BOOL' label), 'STAT' (connected to a 'UINT' label), and 'ENC_VAL' (connected to a 'DINT' label').</p> </div>	<p>Input</p> <p>REQ : Request for executing function blocks</p> <p>BASE : Setting up the numbers of the bases where modules are equipped</p> <p>SLOT : Setting up the numbers of slots where modules are equipped</p> <p>ENC : Encoder No. (set as 0 all the time)</p> <p>0: Encoder</p> <p>Output</p> <p>DONE : Keeping 1 after the initial operation</p> <p>STAT : Outputting error No. that occurred during executing function blocks</p> <p>ENC_VAL : Encoder's current values</p>

- (1) The command for reading encoder's values is sent to the embedded positioning.
- (2) Then, the obtained current values of the encoder are displayed in ENC_VAL,
- (3) You can set up the encoder to read in ENC. For the XECU embedded positioning, it should be set as 0 all the time.

6.4 Function blocks related to parameters/changing operating data

6.4.1 Teaching basic parameters (XPM_SBP)

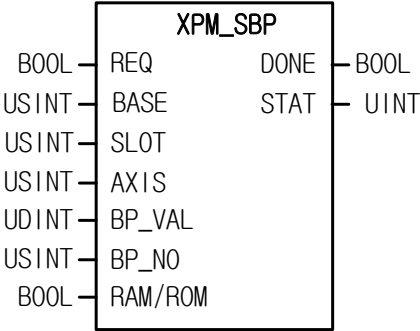
Function Block Type	Details
 <p>The diagram shows a rectangular block labeled 'XPM_SBP'. On the left side, there are seven input lines: a Boolean line labeled 'REQ', two USINT lines labeled 'BASE' and 'SLOT', a USINT line labeled 'AXIS', a UDINT line labeled 'BP_VAL', a USINT line labeled 'BP_NO', and a Boolean line labeled 'RAM/ROM'. On the right side, there are two output lines: a Boolean line labeled 'DONE' and a UINT line labeled 'STAT'.</p>	<p>Input</p> <ul style="list-style-type: none"> REQ : Request for executing function blocks BASE : Setting up the numbers of the bases where modules are equipped SLOT : Setting up the numbers of slots where modules are equipped AXIS : Specifying the axis to give commands 1 ~ 4: 1 ~ 4axis BP_VAL : Basic parameter values to change BP_NO : Basic parameter items No. to change RAM/ROM : Method on how to save parameters 0: SAVING TO RAM 1: SAVING TO ROM <p>Output</p> <ul style="list-style-type: none"> DONE : Keeping 1 after the initial operation STAT : Outputting error No. that occurred during executing function blocks

- (1) The command for setting up the basic parameters is sent to the specified axis in AXIS of the embedded positioning.
- (2) The parameter value that is set as "0" in RAM/ROM and changed by the basic parameter teaching commands is valid only while the power is On. If you want to maintain the changed parameter value even while the power is Off, set the value as "1" in RAM/ROM and perform the basic parameter teaching commands or after teaching basic parameters, save the changed parameter value to the Flash by using the commands for saving parameters/operating data(XPM_WRT).
- (3) In AXIS, you can set up the axis to command and select one among 1~4. If the values other than set ones are selected, "error6" will occur.
- (4) The command for setting basic parameters can be executed only when all axes are in a stopped state.
- (5) If you change the data through ROM teaching, it will be saved to the FLASH together with the previous parameters changed by RAM teaching including the parameters changed by the current commands. However, for different axes other than the relevant ones, the previous data will not be saved to the FLASH.
- (5) You can set up the values for basic parameter items No. as below.

Set value	Item	Setting range
1	Speed limit	mm : 1 ~ 2,147,483,647 [$\times 10^{-2}$ mm/minute] Inch : 1 ~ 2,147,483,647 [$\times 10^{-3}$ Inch/minute] degree : 1 ~ 2,147,483,647 [$\times 10^{-3}$ degree/minute] pulse : 1 ~ 2,000,000 [pulse/second]
2	Acceleration time 1	1 ~ 2,147,483,647 [ms]
3	Acceleration time 2	
4	Acceleration time 3	
5	Acceleration time 4	

Set value	Item	Setting range
6	Deceleration time 1	1 ~ 2,147,483,647 [ms]
7	Deceleration time 2	
8	Deceleration time 3	
9	Deceleration time 4	
10	Abrupt stop deceleration time	1 ~ 2,147,483,647 [ms]
11	The number of divided output pulses per revolution	1 ~ 200,000,000
12	Travel distance per revolution	
13	Unit	0:Pulse, 1:mm, 2:Inch, 3:Degree
14	Unit double precision	0: x 1, 1: x 10, 2: x 100, 3: x 1000
15	Speed command unit	0: unit/time, 1: rpm
16	Bias speed	1 ~ speed limit
17	Pulse output mode	0: CW/CCW, 1: PLS/DIR, 2: PHASE

6.4.2 Teaching extended parameters (XPM_SEP)

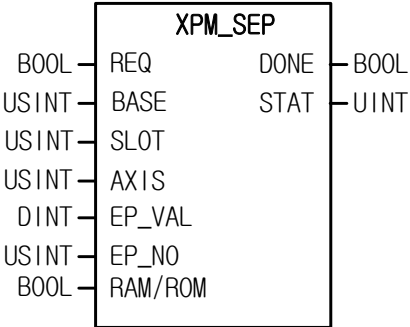
Function Block Type	Details
 <p>The diagram shows a rectangular block labeled 'XPM_SEP'. On the left side, there are seven input terminals: 'REQ' (type: BOOL), 'BASE' (type: USINT), 'SLOT' (type: USINT), 'AXIS' (type: USINT), 'EP_VAL' (type: DINT), 'EP_NO' (type: USINT), and 'RAM/ROM' (type: BOOL). On the right side, there are two output terminals: 'DONE' (type: BOOL) and 'STAT' (type: UINT).</p>	<p>Input</p> <ul style="list-style-type: none"> REQ : Request for executing function blocks BASE : Setting up the numbers of the bases where modules are equipped SLOT : Setting up the numbers of slots where modules are equipped AXIS : Specifying the axis to give commands 1 ~ 4: 1axis ~ 4axis EP_VAL : Extended parameter values to change EP_NO : Extended parameter items No. to change RAM/ROM : Method on how to save parameters 0: SAVING TO RAM 1: SAVING TO ROM <p>Output</p> <ul style="list-style-type: none"> DONE : Keeping 1 after the initial operation STAT : Outputting error No. that occurred during executing function blocks

- (1) The command for teaching extended parameters is sent to the axis specified as AXIS of the embedded positioning.
- (2) The parameter value that is set as "0" in RAM/ROM and changed by the extended parameter setting commands is valid only while the power is On. If you want to maintain the changed parameter value even while the power is Off, set the value as "1" in RAM/ROM and perform the extended parameter teaching commands or after teaching extended parameters, save the changed parameter value to the Flash by using the commands for saving parameters/operating data(XPM_WRT).
- (3) In AXIS, you can set up the axis to command and select one among 1~4. If the values other than set ones are selected, "error6" will occur.
- (4) The command for setting extended parameters can be executed only when all axes are in a stopped state.
- (5) You can set up the values for extended parameter items No. as below.

Set value	Item	Setting range
1	Soft upper limit	mm :-2147483648 ~ 2147483647[X10 ⁻⁴ mm] Inch:-2147483648 ~ 2147483647[X10 ⁻⁵ Inch]
2	Soft lower limit	degree:-2147483648 ~ 2147483647[X10 ⁻⁵ degree] pulse:-2147483648 ~ 2147483647[pulse]
3	Compensation amount of backlash	mm: 0 ~ 65,535[X10 ⁻⁴ mm] inch: 0 ~ 65,535[X10 ⁻⁵ Inch] degree: 0 ~ 65,535[X10 ⁻⁵ degree] pulse: 0 ~ 65,535[pulse]
4	Completion time of positioning	0 ~ 65,535[ms]
5	S-curve ratio	1 ~ 100
6	2 axis linear interpolated continuous operation with insertion position of a circular arc	mm: 0 ~ 2147483647[X10 ⁻⁴ mm] Inch: 0 ~ 2147483647[X10 ⁻⁵ Inch] degree: 0 ~ 2147483647[X10 ⁻⁵ degree] pulse: 0 ~ 2147483647[pulse]
7	Accel/decel pattern	0: Trapezoidal operation, 1: S-curve operation
8	M code mode	0: None, 1: With, 2: After
9	Detection of upper/lower limit during speed control	0: No detected, 1: Detected
10	Servo alarm reset time	1~5000[ms]
11	Interpolated continuous operation positioning type	0: Passing the target position , 1: Passing the vicinity
12	2 axis linear interpolated continuous operation with insertion of a circular arc	0: No insertion of a circular arc, 1: Continuous operation with insertion of a circular arc
13	Selecting external Emergency Stop/Deceleration Stop	0: Emergency Stop, 1: Deceleration Stop
14	Positioning speed override coordinate	0: Absolute coordinate, 1: Relative coordinate
15	Pulse output direction	0: Forward, 1:Reverse
16	Position repeating Infinite length	mm: 1 ~ 2147483647[X10 ⁻⁴ mm] Inch: 1 ~ 2147483647[X10 ⁻⁵ Inch] degree: 1 ~ 2147483647[X10 ⁻⁵ degree] pulse: 1 ~ 2147483647[pulse]

Chapter 6 Function block

17	Repetition of Infinite length	0: Prohibited, 1: Allowed
18	Speed/position switching coordinate	0: Relative coordinate, 1: Relative coordinate
19	Selecion of interpolation speed	0: Major axis speed 1: Resultant speed

(6) If you change the data through ROM teaching, it will be saved to the FLASH together with the previous parameters changed by RAM teaching including the parameters changed by the current commands. However, for different axes other than the relevant ones, the previous data will not be saved to the FLASH.

6.4.3 Homing parameters teaching (XPM_SHP)

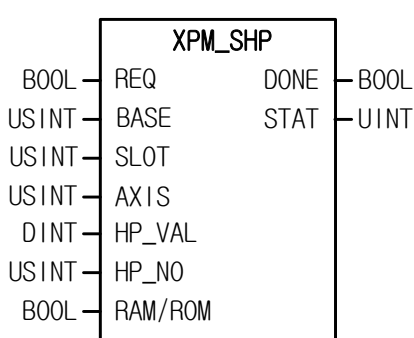
Function Block Type	Details
	<p>Input</p> <p>REQ : Request for executing function blocks</p> <p>BASE : Setting up the numbers of the bases where modules are equipped</p> <p>SLOT : Setting up the numbers of slots where modules are equipped</p> <p>AXIS : Specifying the axis to give commands(1 ~ 4: 1axis ~ 4axis)</p> <p>HP_VAL : Homing parameter values to change</p> <p>HP_NO : Items No. of homing parameters to change</p> <p>RAM/ROM : Method on how to save parameters(0: RAM, 1: ROM)</p> <p>Output</p> <p>DONE : Keeping 1 after the initial operation</p> <p>STAT : Outputting error No. that occurred during executing function blocks</p>

- (1) The command for teaching homing parameters is sent to the axis specified as AXIS of the embedded positioning.
- (2) The parameter value that is set as "0" in RAM/ROM and changed by the homing parameter teaching commands is valid only while the power is On. If you want to maintain the changed parameter value even while the power is Off, set the RAM/ROM as "1" and perform the homing parameter teaching commands or after teaching homing parameters, save the changed parameter value to the Flash by using the commands for saving parameters/operating data(XPM_WRT).
- (3) In AXIS, you can set up the axis to command and select one among 1~4. If the values other than set ones are selected, "error6" will occur.
- (4) The command for setting homing parameters can be executed only when all axes are in a stopped state.
- (5) You can set up the values for homing parameter items No. as below.

Set value	Item	Setting range
1	Home position	mm : -2147483648 ~ 2147483647 [X10 ⁻⁴ mm] Inch : -2147483648 ~ 2147483647 [X10 ⁻⁵ Inch] degree : -2147483648 ~ 2147483647 [X10 ⁻⁵ degree] pulse : -2147483648 ~ 2147483647 [pulse]
2	Homing high speed	mm : 1 ~ 2,147,483,647 [X10 ⁻² mm/minute] Inch : 1 ~ 2,147,483,647 [X10 ⁻³ Inch/minute]
3	Homing low speed	degree : 1 ~ 2,147,483,647 [X10 ⁻³ degree/minute] pulse : 1 ~ 2,000,000 [pulse/second]
4	Homing acceleration time	0 ~ 2,147,483,647 [ms]
5	Homing deceleration time	
6	Homing dwell time	0 ~ 65,535[ms]
7	Compensation amount of origin	mm : -2147483648 ~ 2147483647 [X10 ⁻³ mm] Inch : -2147483648 ~ 2147483647 [X10 ⁻⁵ Inch] degree : -2147483648 ~ 2147483647 [X10 ⁻⁵ degree] pulse : -2147483648 ~ 2147483647 [pulse]

Chapter 6 Function block

8	Homing restart-up time	0 ~ 65,535[ms]
9	Homing mode	0:Approximate origin/origin(Off), 1:Approximate origin/origin(On), 2:Upper/lower limit/origin, 3:Approximate origin, 4:High speed origin, 5:Upper/lower limit, 6:Origin
10	Homing direction	0:Forward, 1:Reverse

- (6) If you change the data through ROM teaching, it will be saved to the FLASH together with the previous parameters changed by RAM teaching including the parameters changed by the current commands. However, for different axes other than the relevant ones, the previous data will not be saved to the FLASH.

6.4.4 Manual operation parameters teaching(XPM_SMP)

Function Block Type	Details
	<p>Input</p> <p>REQ : Request for executing function blocks BASE : Setting up the numbers of the bases where modules are equipped SLOT : Setting up the numbers of slots where modules are equipped AXIS : Specifying the axis to give commands 1 ~ 4: 1axis ~ 4axis MP_VAL : Manual operation parameter values to change MP_NO : Manual operation parameter items No. to change RAM/ROM : Method on how to save parameters 0: SAVING TO RAM 1: SAVING TO ROM</p> <p>Output</p> <p>DONE : Keeping 1 after the initial operation STAT : Outputting error No. that occurred during executing function blocks</p>

- The command for teaching manual operation parameters is sent to the axis specified as AXIS of the embedded positioning.
- The parameter value that is set as "0" in RAM/ROM and changed by the commands for teaching manual operation parameters is valid only while the power is On. If you want to maintain the changed parameter value even while the power is Off, set the RAM/ROM as "1" and perform the commands for teaching manual operation parameters or after setting manual operation parameters, save the changed parameter value to the Flash by using the commands for saving parameters/operating data(XPM_WRT).
- In AXIS, you can set up the axis to command and select one among 1~4. If the values other than set ones are selected, "error6" will occur.
- The command for setting manual operation parameters can be executed only when all axes are in a stopped state.
- You can set up the values for manual operation parameter items No. as below.

Set value	Item	Setting range
1	JOG high speed	mm : 1 ~ 2,147,483,647 [X10 ⁻² mm/minute] Inch : 1 ~ 2,147,483,647 [X10 ⁻³ Inch/minute]
2	JOG low speed	degree : 1 ~ 2,147,483,647 [X10 ⁻³ degree/minute] pulse : 1 ~ 2,000,000 [pulse/second]

3	JOG acceleration time	0 ~ 2,147,483,647 [ms]
4	JOG deceleration time	
5	Inchingspeed	mm : 1 ~ 65,535[X10 ⁻² mm/minute] Inch : 1 ~ 65,535[X10 ⁻³ Inch/minute] degree : 1 ~ 65,535[X10 ⁻³ degree/minute] pulse : 1 ~ 65,535[pulse/second]

- (6) If you change the data through ROM teaching, it will be saved to the FLASH together with the previous parameters changed by RAM teaching including the parameters changed by the current commands. However, for different axes other than the relevant ones, the previous data will not be saved to the FLASH.

6.4.5 I/O signal parameters teaching (XPM_SIP)

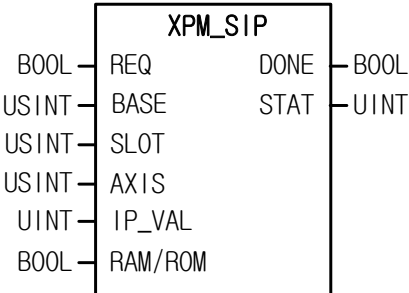
Function Block Type	Details
	<p>Input</p> <p>REQ : Request for executing function blocks BASE : Setting up the numbers of the bases where modules are equipped SLOT : Setting up the numbers of slots where modules are equipped AXIS : Specifying the axis to give commands 1 ~ 4: 1axis ~ 4axis IP_VAL : External signal parameter value to change Set the signal allocated for each Bit RAM/ROM : Method on how to save parameters 0: SAVING TO RAM 1: SAVING TO ROM</p> <p>Output</p> <p>DONE : Keeping 1 after the initial operation STAT : Outputting error No. that occurred during executing function blocks</p>

- (1) The command for teaching external signal parameters is sent to the axis specified as AXIS of the embedded positioning.
- (2) The parameter value that is set as "0" in RAM/ROM and changed by the commands for teaching external signal parameters is valid only while the power is On. If you want to maintain the changed parameter value even while the power is Off, set the RAM/ROM as "1" and perform the commands for teaching external signal parameters or after setting external signal parameters, save the changed parameter value to the Flash by using the commands for saving parameters/operating data(XPM_WRT).
- (3) In AXIS, you can set up the axis to command and select one among 1~4. If the values other than set ones are selected, "error6" will occur.
- (4) The command for setting I/O signal parameters can be executed only when all axes are in a stopped state.
- (5) The set value of each external signal setting area indicates the below.
0: A contact, 1: B contact
- (6) The external signals allocated for each Bit of I/O signal parameters to change are as follows.

Bit	Signal
0	Upper limit signal
1	Lower limit signal
2	Approximate origin signal
3	Origin signal
4	Emergency Stop/decelerationStop signal
5	Drive Ready signal
6	Servo-On outputsignal
7	Servo alarm reset outputsignal
8 ~ 15	N/A

- (7) If you change the data through ROM teaching, it will be saved to the FLASH together with the previous parameters changed by RAM teaching including the parameters changed by the current commands. However, for different axes other than the relevant ones, the previous data will not be saved to the FLASH.

6.4.6 Common parameters teaching (XPM_SCP)

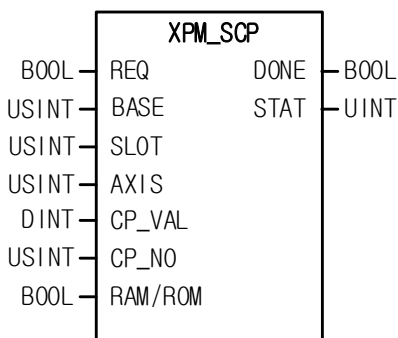
Function Block Type	Details
	<p>Input</p> <p>REQ : Request for executing function blocks BASE : Setting up the numbers of the bases where modules are equipped SLOT : Setting up the numbers of slots where modules are equipped AXIS : Specifying the axis to give commands 1 ~ 4: 1axis ~ 4axis CP_VAL : Values of common parameters to change CP_NO : Common parameter items No. to change RAM/ROM : Method on how to save parameters 0: SAVING TO RAM 1: SAVING TO ROM</p> <p>Output</p> <p>DONE : Keeping 1 after the initial operation STAT : Outputting error No. that occurred during executing function blocks</p>

- (1) The command for teaching common parameters is sent to the axis specified as AXIS of the embedded positioning.
- (2) The parameter value that is set as “0” in RAM/ROM and changed by the commands for teaching common parameters is valid only while the power is On. If you want to maintain the changed parameter value even while the power is Off, set the RAM/ROM as “1” and perform the commands for teaching common parameters or after teaching common parameters, save the changed parameter value to the Flash by using the commands for saving parameters/operating data(XPM_WRT).
- (3) In AXIS, you can set up the axis to command and select one among 1~4. If the values other than set ones are selected, “error6” will occur.
- (4) You can set up the values for common parameter items No. as below.

Set value	Item	Setting range
1	Speed override mode	0 : Designation of %, 1 : Designation of speed
2	Encoder pulse input mode	0: CW/CCW multiplied by 1 1: PULSE/DIR multiplied by 1 2: PHASE A/B multiplied by 4
3	Encoder maximum value	-2147483648 ~ 2147283647
4	Encoder minimum value	
5	Pulse output level	0 : Low Active, 1 : High Active
6	Whether allowing continuous operation	0: Prohibited, 1: Allowed

- (5) If you change the data through ROM teaching, it will be saved to the FLASH together with the previous parameters changed by RAM teaching including the parameters changed by the current commands.

6.4.7 Operating data teaching(XPM_SMD)

Function Block Type	Details
	<p>Input</p> <p>REQ : Request for executing function blocks</p> <p>BASE : Setting up the numbers of the bases where modules are equipped</p> <p>SLOT : Setting up the numbers of slots where modules are equipped</p> <p>AXIS : Specifying the axis to give commands 1 ~ 4: 1axis ~ 4axis</p> <p>STEP : Operation step No. to change 0 ~ 400</p> <p>MD_VAL : Operating data value to change</p> <p>MD_NO : Operating data items No. to change</p> <p>RAM/ROM : Method on how to save parameters 0: SAVING TO RAM, 1: SAVING TO ROM</p> <p>Output</p> <p>DONE : Keeping 1 after the initial operation</p> <p>STAT : Outputting error No. that occurred during executing function blocks</p>

- (1) The command for setting operating data is sent to the axis specified as AXIS of the embedded positioning.
- (2) The operating data that is set as "0" in RAM/ROM and changed by the commands for teaching operating data is valid only while the power is On. If you want to maintain the changed operating data even while the power is Off, set the RAM/ROM as "1" and perform the commands for teaching operating data or after teaching operating data, save the changed parameter value to the Flash by using the commands for saving parameters/operating data(XPM_WRT).
- (3) In AXIS, you can set up the axis to command and select one among 1~4. If the values other than set ones are selected, "error6" will occur.
- (4) The command for setting operating data can be executed only when all axes are in a stopped state.

(5) You can set up the values for operating data items No. as below.

Set value	Item	Setting range																
1	Target position	mm : -2147483648 ~ 2147483647 [X10 ⁻⁴ mm] Inch : -2147483648 ~ 2147483647 [X10 ⁻⁵ Inch] degree : -2147483648 ~ 2147483647 [X10 ⁻⁵ degree] pulse : -2147483648 ~ 2147483647 [pulse]																
2	Auxiliary position for circular interpolation																	
3	Operating speed	mm : 1 ~ 2,147,483,647 [X10 ⁻² mm/minute] Inch : 1 ~ 2,147,483,647 [X10 ⁻³ Inch/minute] degree : 1 ~ 2,147,483,647 [X10 ⁻³ degree/minute] pulse : 1 ~ 2,000,000 [pulse/second]																
4	Dwell time	0 ~ 65,535[ms]																
5	M code No.	0 ~ 65,535																
6	Minor axis setup	Bit setup <table border="1"> <thead> <tr> <th>Bit 7</th> <th>Bit 6</th> <th>Bit 5</th> <th>Bit 4</th> <th>Bit 3</th> <th>Bit 2</th> <th>Bit 1</th> <th>Bit 0</th> </tr> </thead> <tbody> <tr> <td>-</td> <td>-</td> <td>-</td> <td>-</td> <td>axis4</td> <td>axis3</td> <td>axis2</td> <td>axis1</td> </tr> </tbody> </table>	Bit 7	Bit 6	Bit 5	Bit 4	Bit 3	Bit 2	Bit 1	Bit 0	-	-	-	-	axis4	axis3	axis2	axis1
Bit 7	Bit 6	Bit 5	Bit 4	Bit 3	Bit 2	Bit 1	Bit 0											
-	-	-	-	axis4	axis3	axis2	axis1											
7	Helical Interpolation axis	0, 1axis ~ 4axis (0 indicates normal circular interpolation.)																
8	Number of circular interpolation turns	0~65,535																
9	Coordinate	0: Absolute coordinate, 1: Relative coordinate																
10	Control mode	0:Single axis position control, 1: Single axis speed control, 2:Single axis Feed control, 3:linear interpolation, 4:circular interpolation																
11	Operation method	0: isolated, 1: repetitive																
12	Operation pattern	0:End, 1:Keeping On, 2:Continuous																
13	Circular arc size	0:a circular arc<180 1:a circular arc>=180																
14	Acceleration No.	0 ~ 3																
15	Deceleration No.	0 ~ 3																
16	Circular interpolation method	0:Midpoint, 1:Center point, 2:Radius																
17	Circular interpolation direction	0:CW, 1:CCW																

(6) If you change the data through ROM teaching, it will be saved to the FLASH together with the previous parameters changed by RAM teaching including the parameters changed by the current commands. However, for different axes other than the relevant ones, the previous data will not be saved to the FLASH.

6.4.8 Multiple teaching(XPM_ATEA)

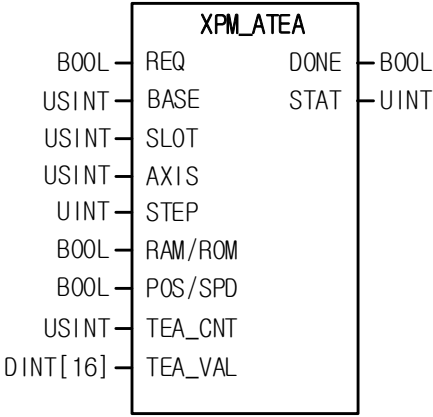
Function Block Type	Details
	<p>Input</p> <p>REQ : Request for executing function blocks</p> <p>BASE : Setting up the numbers of the bases where modules are equipped</p> <p>SLOT : Setting up the numbers of slots where modules are equipped</p> <p>AXIS : Specifying the axis to give commands 1 ~ 4: 1axis ~ 4axis</p> <p>STEP : Setting the step No. to teach 0 ~ 400</p> <p>RAM/ROM : Selecting RAM teaching and ROM teaching type 0 : RAM teaching, 1 : ROM teaching</p> <p>POS/SPD : Selecting position teaching and speed teaching type 0 : position teaching, 1 : speed teaching</p> <p>TEA_CNT : Setting the number of teaching data 1 ~ 16</p> <p>TEA_VAL : Setting teaching values</p> <p>Output</p> <p>DONE : Keeping 1 after the initial operation</p> <p>STAT : Outputting error No. that occurred during executing function blocks</p>

- (1) The command for multiple teaching is sent to the axis specified as AXIS of the embedded positioning.
- (2) The speed teaching can be used when a user wants to apply the arbitrary speed value to a specific step's operating data; the position teaching can be used when a user wants to set the arbitrary position value for a specific step's operating data.
- (3) It is used when you want to change the target position or speed values up to 16EA at once by using the multiple teaching function blocks.
- (4) In AXIS, you can set up the axis to command and select one among 1~4. If the values other than set ones are selected, "error6" will occur.
- (5) The teaching command can be executed only when all axes are in a stopped state.
- (6) In STEP, you can set the step No. of the operating data to teach and select one among 0 ~ 400. If the values other than set ones are selected, "error 11" will occur.
- (7) In TEA_CNT, you can set the number of teaching data up to 16EA. If the values other than set ones are selected, "error 11" will occur.
- (8) The operating data that is set as "0" in RAM/ROM and changed by teaching commands is valid only while the power is On. If you want to maintain the changed operating data even while the power is Off, set the RAM/ROM as "1" and perform the teaching commands or after teaching operating data, save the changed parameter value to the Flash by using the commands for saving parameters/operating data(XPM_WRT).
- (9) If you change the data through ROM teaching, it will be saved to the FLASH together with the previous operating data changed by RAM teaching including the operating data changed by the current commands. However, for different axes other than the relevant ones, the previous data will not be saved to the FLASH.

6.4.9 Reading variable data (XPM_VRD)

Function Block Type	Details
	<p>Input</p> <p>REQ : Request for executing function blocks</p> <p>BASE : Setting up the numbers of the bases where modules are equipped</p> <p>SLOT : Setting up the numbers of slots where modules are equipped</p> <p>AXIS : Specifying the axis to give commands 1 ~ 4: 1axis ~ 4axis</p> <p>S_ADDR : Start address of the module internal memory of the data to read 0 ~ 49586</p> <p>OFFSET : Offset of between data blocks to read 0 ~ 49586</p> <p>SIZE : Size of data blocks to read 1 ~ 128</p> <p>CNT : The number of data blocks to read 1 ~ 128</p> <p>Output</p> <p>DONE : Keeping 1 after the initial operation</p> <p>STAT : Outputting error No. that occurred during executing function blocks</p> <p>VAR : PLC device where the read data is stored.</p>

- (1) The command gives instructions to the positioning module to read directly parameters, operating data, CAM data.
- (2) It is possible to read the desired data by specifying parameters and operating data, CAM data's module internal memory address directly.
- (3) Among parameters, operating data, CAM data of the embedded positioning, the command is to read as much data as the "SIZE" in WORDs from the position set as "S_ADDR" in positioning module internal memory to the specified device of "VAR". In case "CNT" is more than 2, it reads the blocks one by one, which are as distant as "OFFSET" from the "S_ADDR" position as many times as "CNT"-1 and saves them to the specified device of "VAR".
- (4) The maximum data size(SIZE x CNT) that can be read with a command is 128 WORD.
- (5) The command for "Reading Variable Data" can run even during operation.
- (6) In AXIS, you can set up the axis to command and select one among 1~4. If the values other than set ones are selected, "error 6" will occur.
- (7) In case the size(SIZE x CNT) of the data to read is 0 or exceeds 128 WORD, error "11" will occur in STAT.
- (8) Although reading variable data is executed for different axes, it can run only once in one scan. If you run reading variable data more than twice in one scan, error code(811) will occur and the remaining operations except the first reading variable data will not work.

6.4.10 Writing variable data (XPM_VWR)

Function Block Type	Details
	<p>Input</p> <p>REQ : Request for executing function blocks</p> <p>BASE : Setting up the numbers of the bases where modules are equipped</p> <p>SLOT : Setting up the numbers of slots where modules are equipped</p> <p>AXIS : Specifying the axis to give commands 1 ~ 4: 1axis ~ 4axis</p> <p>VAR : PLC device where the data to write is saved</p> <p>T_ADDR : Start address of the module internal memory of the data to write 0 ~ 49586</p> <p>OFFSET : Offset of between data blocks to write 0 ~ 49586</p> <p>SIZE : Size of the data blocks to write 1 ~ 128</p> <p>CNT : Number of data blocks to write 1 ~ 128</p> <p>Output</p> <p>DONE : Keeping 1 after the initial operation</p> <p>STAT : Outputting error No. that occurred during executing function blocks</p>

- (1) The command gives instructions to the positioning module to write directly parameters, operating data, CAM data.
- (2) It is possible to write the desired data by specifying parameters and operating data, CAM data's module internal memory address directly.
- (3) Among parameters, operating data, CAM data of the embedded positioning internal memory, the command is to write as much data as the "SIZE" in WORDs from the "T_ADDR" position of the PLC program to the specified device of "VAR". In case the number of blocks, "CNT" is more than 2, it writes the data one by one to the blocks which are as distant as "OFFSET" from the ones located in "T_ADDR" position as many times as "CNT"-1.
- (4) The maximum data size(SIZE x CNT) that can be written with a command is 128 WORD.
- (5) The command for "Writing Variable Data" cannot run during operation.
- (6) In AXIS, you can set up the axis to command and select one among 1~4. Establishing the values other than set ones will lead to "error6".
- (7) In case the size(SIZE x CNT) of the data to read is 0 or exceeds 128 WORD, error "11" will occur in STAT.
- (8) If the number of blocks(CNT) is more than 2 and block offset(OFFSET) is smaller than the block size(CNT), the module internal memory blocks where the data will be written are overlapping so error "11" will occur in STAT.
- (9) When executing XPM_WRT, compatibility of data should be checked for all access areas. Especially, the user CAM area is set as 0 initially but if you input 0 again through XPM_WRT, data compatibility error will occur(error code 704~708). For data setting of the user CAM area, refer to 8.4.4 User CAM Operation.

6.4.11 Saving parameters/operating data(XPM_WRT)

Function Block Type	Details
	<p>Input</p> <p>REQ : Request for executing function blocks</p> <p>BASE : Setting up the numbers of the bases where modules are equipped</p> <p>SLOT : Setting up the numbers of slots where modules are equipped</p> <p>AXIS : Specifying the axis to give commands 1 ~ 4: 1axis ~ 4axis</p> <p>WRT_AXIS : Setting axis to save (by setting each bit) 0bit ~ 3bit: 1axis ~ 4axis</p> <p>Output</p> <p>DONE : Keeping 1 after the initial operation</p> <p>STAT : Outputting error No. that occurred during executing function blocks</p>

(1) The command for saving parameters/operating data is sent to the axis specified as AXIS of the embedded positioning.

(2) In AXIS, you can set up the axis to command and select one among 1~4. If the values other than set ones are selected, "error 6" will occur.

(3) After function blocks are normally performed, it saves the current parameters and operating data of the axis set in WRT_AXIS to the Flash so that the data can be maintained even when the power is off.

(4) For setting WRT_AXIS, select the Bit corresponding to each axis.

15 ~ 4 Bit	3Bit	2Bit	1Bit	0Bit
N/A	4axis	3axis	2axis	1axis

For example, to select 2 axis and 3 axis, you can set them as "16#06".

(5) If you modify the data with the command for writing variable data(XPM_VWR), the CAM data that changed during XPM_WRT will be saved to the Flash.

6.5 Function blocks related to Start-up and Stop

6.5.1 Homing start-up(XPM_ORG)

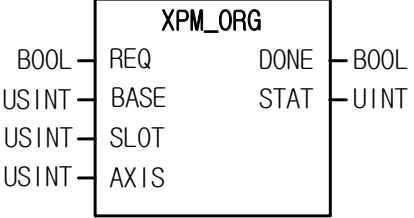
Function Block Type	Details
	<p>Input</p> <p>REQ : Request for executing function blocks</p> <p>BASE : Setting up the numbers of the bases where modules are equipped</p> <p>SLOT : Setting up the numbers of slots where modules are equipped</p> <p>AXIS : Specifying the axis to give commands 1 ~ 4: 1axis ~ 4axis</p> <p>Output</p> <p>DONE : Keeping 1 after the initial operation</p> <p>STAT : Outputting error No. that occurred during executing function blocks</p>

(1) It gives homing command to the positioning module.

(2) It is the operation command to find the origin of the machine based on homing mode with direction, compensation amount, speed(high speed, low speed), address and dwell time that are set as homing parameters of each axis.

(3) The homing command is sent to the axis specified as AXIS of the embedded positioning.

(4) In AXIS, you can set up the axis to command and select one among 1~4. If the values other than set ones are selected, "error 6" will occur.

(5) When the homing command is normally performed, homing will start up based on the way set in "homing mode" of "homing parameters".

6.5.2 Direct start-up(XPM_DST)

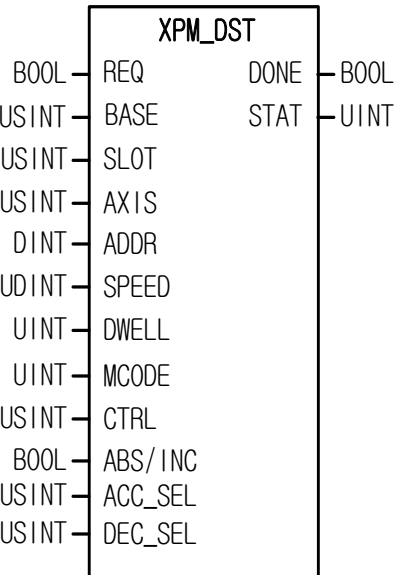
Function Block Type	Details
	<p>Input</p> <p>REQ : Request for executing function blocks</p> <p>BASE : Setting up the numbers of the bases where modules are equipped</p> <p>SLOT : Setting up the numbers of slots where modules are equipped</p> <p>AXIS : Specifying the axis to give commands 1 ~ 4: 1 ~ 4axis</p> <p>ADDR : Setting up the target position address -2147483648 ~ +2147483647</p> <p>SPEED :Setting up the target speed</p> <p>DWELL : Setting up dwell time 0 ~ 65535[ms]</p> <p>M code : Setting up M code value</p> <p>CTRL : Control mode setting 0: position control, 1: speed control, 2: Feed control, 3: the shortest distance control</p> <p>ABS/INC: Setting absolute coordinate/relative coordinate 0: absolute coordinate, 1: relative coordinate</p> <p>ACC_SEL: Setting up acceleration time No. 0: acceleration time1, 1: acceleration time2 2: acceleration time3, 3: acceleration time4</p> <p>DCC_SEL: Setting up deceleration time No. 0: deceleration time 1, 1: deceleration time 2 2: deceleration time 3, 3: deceleration time 4</p> <p>Output</p> <p>DONE : Keeping 1 after the initial operation</p> <p>STAT : Outputting error No. that occurred during executing function blocks</p>

- (1) The command for direct start-up is sent to the axis specified as AXIS of the embedded positioning.
- (2) It can be used when you want to operate directly the machine by setting the target position address, operating speed, dwell time, M code No., control mode, coordinate, accel'decel time No. rather than depending on operating data.
- (3) In AXIS, you can set up the axis to command and select one among 1~4. If the values other than set ones are selected, "error 6" will occur.
- (4) In case the values set for SPEED, CTRL, TIME_SEL exceed the setting range, "error11" will occur in STAT.

6.5.3 Indirect start-up(XPM_IST)

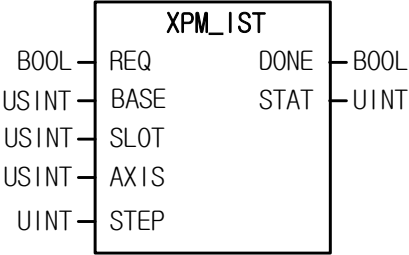
Function Block Type	Details
	<p>Input</p> <p>REQ : Request for executing function blocks</p> <p>BASE : Setting up the numbers of the bases where modules are equipped</p> <p>SLOT : Setting up the numbers of slots where modules are equipped</p> <p>AXIS : Specifying the axis to give commands 1 ~ 4: 1axis ~ 4axis</p> <p>STEP : Step No. to operate 0 ~ 400</p> <p>Output</p> <p>DONE : Keeping 1 after the initial operation</p> <p>STAT : Outputting error No. that occurred during executing function blocks</p>

- (1) The command for indirect start-up is sent to the axis specified as AXIS of the embedded positioning.
- (2) It can be used when you want to operate the machine by setting operation step No. of the axis that is set as operating data.
- (3) In AXIS, you can set up the axis to command and select one among 1~4. If the values other than set ones are selected, "error 6" will occur.
- (4) In case the set value of STEP exceed the setting range(0 ~ 400), "error11" will occur in STAT.
- (5) If you set 0 for STEP, the current step will be operated.
- (6) The linear interpolation and a circular arc interpolation, helical interpolation is performed with indirect start-up command by setting control mode of operating data.

6.5.4 Ellipse interpolation (XPM_ELIN)

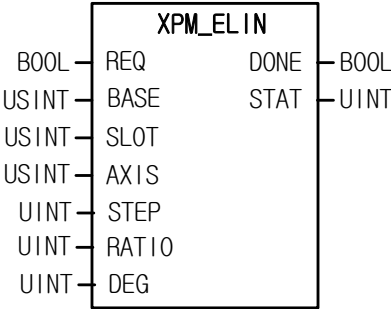
Function Block Type	Details
	<p>Input</p> <p>REQ : Request for executing function blocks</p> <p>BASE : Setting up the numbers of the bases where modules are equipped</p> <p>SLOT : Setting up the numbers of slots where modules are equipped</p> <p>AXIS : Specifying the axis to give commands 1 ~ 4: 1axis ~ 4axis</p> <p>STEP : Step No. to operate</p> <p>RATIO : ellipse ratio(%)</p> <p>DEG : Operating angle</p> <p>Output</p> <p>DONE : Keeping 1 after the initial operation</p> <p>STAT : Outputting error No. that occurred during executing function blocks</p>

- (1) The command for ellipse interpolation is sent to the axis specified as AXIS of the embedded positioning.
- (2) For the specified step of STEP in the specified axis, the ellipse interpolation is performed at the angle set in DEG in the ratio set in RATIO.
- (3) The ellipse interpolation distorts the operating data of the step that is set as circular interpolation in the ratio of ellipse ratio(RATIO) and performs ellipse operation at the operating angle set in DEG. Therefore, the step of the operating data set in STEP should be set up based on circular interpolation control.
- (4) The ellipse ratio can be set in the range of 1 ~ 65535 and its unit is [X10⁻²%]. Namely, if the value is set as 65535, you will get 655.35%.
- (5) The operating angle can be set in the range of 1 ~ 65535 and its unit is [X10⁻¹degree]. Namely, if the value is set as 3650, you will get 365.0 degree.
- (6) In AXIS, you can set up the axis to command and select one among 1~4. If the values other than set ones are selected, "error 6" will occur.

6.5.5 Synchronous start-up(XPM_SST)

Function Block Type	Details
	<p>Input</p> <p>REQ : Request for executing function blocks</p> <p>BASE : Setting up the numbers of the bases where modules are equipped</p> <p>SLOT : Setting up the numbers of slots where modules are equipped</p> <p>SST_AXIS : Setting synchronous start-up axis 0bit ~ 3bit: 1axis ~ 4axis</p> <p>Setting the bit for each axis</p> <p>A1_STEP : 1axis step No. to start up</p> <p>A2_STEP : 2axis step No. to start up</p> <p>A3_STEP : 3axis step No. to start up</p> <p>A4_STEP : 4axis step No. to start up</p> <p>A5_STEP : N/A</p> <p>A6_STEP : N/A</p> <p>A7_STEP : N/A</p> <p>A8_STEP : N/A</p> <p>Output</p> <p>DONE : Keeping 1 after the initial operation</p> <p>STAT : Outputting error No. that occurred during executing function blocks</p>

- (1) The command for synchronous start-up is sent to the axis specified as SST_AXIS of the embedded positioning.
- (2) It can be used when you want to start the operation of more than 2 axes simultaneously.
- (3) If the values other than set ones are input to SST_AXIS, "error6" will occur.

For setting SST_AXIS, select each bit as below.

7bit	6bit	5bit	4bit	3bit	2bit	1bit	0bit
-	-	-	-	4axis	3axis	2axis	1axis

- (4) In A1_STEP ~ A4_STEP, you can set up the step No. for synchronous start-up from 1 axis to 4 axis.

6.5.6 Point operation (XPM_PST)

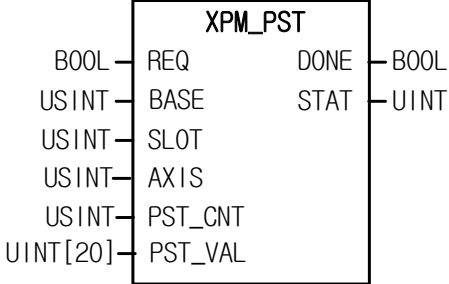
Function Block Type	Details
	<p>Input</p> <p>REQ : Request for executing function blocks</p> <p>BASE : Setting up the numbers of the bases where modules are equipped</p> <p>SLOT : Setting up the numbers of slots where modules are equipped</p> <p>AXIS : Specifying the axis to give commands 1 ~ 4: 1axis ~ 4axis</p> <p>PST_CMT : Setting the number of point operation steps 1 ~ 20</p> <p>PST_VAL : Setting point operation step No. 0 ~ 400</p> <p>Output</p> <p>DONE : Keeping 1 after the initial operation</p> <p>STAT : Outputting error No. that occurred during executing function blocks</p>

- (1) The start-up command is sent to the axis specified as AXIS of the embedded positioning.
- (2) In AXIS, you can set up the axis to command and select one among 1~4. If the values other than set ones are selected, "error 6" will occur.
- (3) It can be used to operate continuously the machine without a stop by setting operation steps up to 20 during PTP(Point to Point) operation with only one command. If PST_CNT or PST_VAL has the values other than set ones, "error6" will occur.
- (4) Point operation allows the maximum of 20 point steps. Accordingly, the variables of UNIT array type with 20 elements can be used for PST_VAL.

6.5.7 Deceleration Stop(XPM_STP)

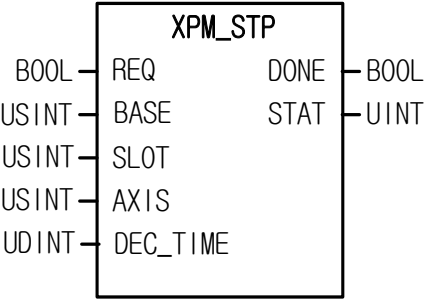
Function Block Type	Details
	<p>Input</p> <p>REQ : Request for executing function blocks</p> <p>BASE : Setting up the numbers of the bases where modules are equipped</p> <p>SLOT : Setting up the numbers of slots where modules are equipped</p> <p>AXIS : Specifying the axis to give commands 1 ~ 4: 1axis ~ 4axis</p> <p>DEC_TIME : Deceleration down-time 0: Accel·decel time applied when operation starts 1 ~ 2147483647: 1 ~ 2147483647ms</p> <p>Output</p> <p>DONE : Keeping 1 after the initial operation</p> <p>STAT : Outputting error No. that occurred during executing function blocks</p>

- (1) The deceleration stop command is sent to the axis specified as AXIS of the embedded positioning.
- (2) If the stop command is given during running by operating data, after deceleration stop, the operation restarts by the start-up command.
- (3) If deceleration stop command is executed in speed synchronization or position synchronization, CAM operation, depending on the current operating control state, speed synchronization or position synchronization, CAM operation will be finished.
- (4) The deceleration stop command can be executed not only in acceleration and constant speed area but also in deceleration area.
- (5) The deceleration time that means the time from start to stop can be set in the range of 0 ~ 2,147,483,647ms. If the value is set as 0, it will stop by the set deceleration time when operation starts.
- (6) The deceleration time means the time required from the speed limit of the axis's basic parameters to stop.
- (7) In AXIS, you can set up the axis to command and select one among 1~4. If the values other than set ones are selected, "error 6" will occur.

6.5.8 Emergency Stop (XPM_EMG)

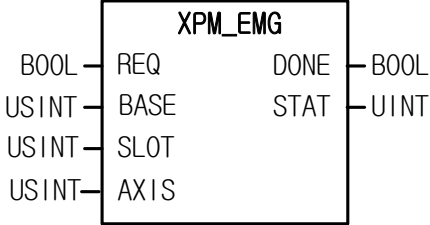
Function Block Type	Details
	<p>Input</p> <p>REQ : Request for executing function blocks</p> <p>BASE : Setting up the numbers of the bases where modules are equipped</p> <p>SLOT : Setting up the numbers of slots where modules are equipped</p> <p>AXIS : Specifying the axis to give commands 1 ~ 4: 1axis ~ 4axis</p> <p>Output</p> <p>DONE : Keeping 1 after the initial operation</p> <p>STAT : Outputting error No. that occurred during executing function blocks</p>

- (1) The Emergency Stop command is sent to the axis specified as AXIS of the embedded positioning.
- (2) It is used when you have to stop the operation immediately due to emergency. The axis where this command is applied will be in a stopped state.
- (3) During Emergency Stop, the deceleration time is the value set in "Deceleration time at abrupt stop" of the basic parameters of each axis.
- (4) In AXIS, you can set up the axis to command and select one among 1~4. If the values other than set ones are selected, "error 6" will occur.

Chapter 6 Function block

6.5.9 Restart-up(XPM_RSTR)

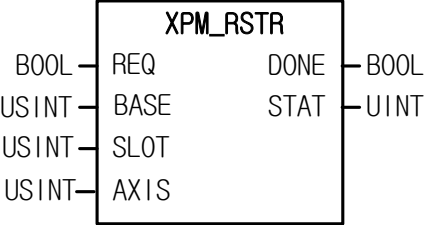
Function Block Type	Details
	<p>Input</p> <p>REQ : Request for executing function blocks</p> <p>BASE : Setting up the numbers of the bases where modules are equipped</p> <p>SLOT : Setting up the numbers of slots where modules are equipped</p> <p>AXIS : Specifying the axis to give commands 1 ~ 4: 1axis ~ 4axis</p> <p>Output</p> <p>DONE : Keeping 1 after the initial operation</p> <p>STAT : Outputting error No. that occurred during executing function blocks</p>

- (1) The restart-up command is sent to the AXIS(command axis) of the embedded positioning.
- (2) It is used to restart up the axis that went through deceleration stop during operation and the axis where the command is executed will restart with the previous operating data.
- (3) If other operations are performed before restart up the axis that went through deceleration stop, the restart-up command will not run.
- (4) In AXIS, you can set up the axis to command and select one among 1~4. If the values other than set ones are selected, "error 6" will occur.

6.6 Function blocks related to manual operation

6.6.1 JOG Operation(XPM_JOG)

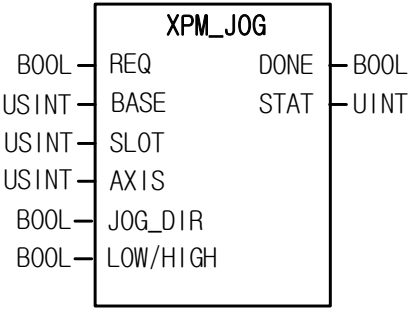
Function Block Type	Details
	<p>Input</p> <p>REQ : Request for executing function blocks</p> <p>BASE : Setting up the numbers of the bases where modules are equipped</p> <p>SLOT : Setting up the numbers of slots where modules are equipped</p> <p>AXIS : Specifying the axis to give commands 1 ~ 4: 1axis ~ 4axis</p> <p>JOG_DIR : Setting the rotating direction during JOG operation 0:forward, 1:reverse</p> <p>LOW/HIGH : Setting the JOG speed during JOG operation 0:JOG low-speed operation, 1:JOG high-speed operation</p> <p>Output</p> <p>DONE : Keeping 1 after the initial operation</p> <p>STAT : Outputting error No. that occurred during executing function blocks</p>

- (1) The JOG operation command is sent to the axis specified as AXIS of the embedded positioning.
- (2) It is the manual operation function for a test and is used to verify the system operations, wiring state, position address for teaching. You can choose either high speed or low speed.
- (3) The operating conditions of JOG function block are level type. Namely, when the access condition of input variables REQ is On, pulses are output based on the set value; when the access condition of input variables REQ is Off, it stops.
- (4) If you change the set values of LOW/HIGH in the state that operating conditions are On(during JOG operation), speed will be changed without stopping JOG operation; if you change set values of LOW/HIGH, after deceleration stop and change of direction, JOG operation will be continued.
- (5) In AXIS, you can set up the axis to command and select one among 1~4. If the values other than set ones are selected, "error 6" will occur.

6.6.2 Inching Operation (XPM_INC)

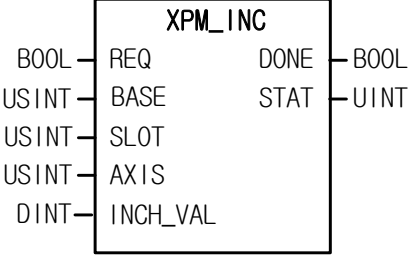
Function Block Type	Details
	<p>Input</p> <p>REQ : Request for executing function blocks</p> <p>BASE : Setting up the numbers of the bases where modules are equipped</p> <p>SLOT : Setting up the numbers of slots where modules are equipped</p> <p>AXIS : Specifying the axis to give commands 1 ~ 4: 1axis ~ 4axis</p> <p>INCH_VAL: Amount of travel to move through inching operation -2,147,483,648 ~ 2,147,483,647</p> <p>Output</p> <p>DONE : Keeping 1 after the initial operation</p> <p>STAT : Outputting error No. that occurred during executing function blocks</p>

- (1) The inching operation command is sent to the axis specified as AXIS of the embedded positioning.
- (2) Inching operation is a kind of manual operations. It is used to process minute movements as quantitative operation.
- (3) The speed of inching operation is set in manual operation parameters.
- (4) In AXIS, you can set up the axis to command and select one among 1~4. If the values other than set ones are selected, "error 6" will occur.

6.6.3 Returning to the position of pre-manual operation (XPM_RTP)

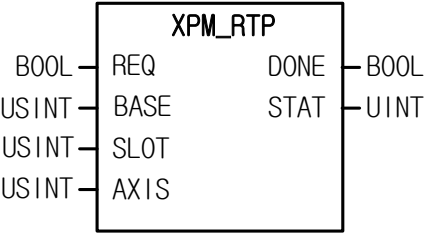
Function Block Type	Details
	<p>Input</p> <p>REQ : Request for executing function blocks</p> <p>BASE : Setting up the numbers of the bases where modules are equipped</p> <p>SLOT : Setting up the numbers of slots where modules are equipped</p> <p>AXIS : Specifying the axis to give commands 1 ~ 4: 1axis ~ 4axis</p> <p>Output</p> <p>DONE : Keeping 1 after the initial operation</p> <p>STAT : Outputting error No. that occurred during executing function blocks</p>

- (1) The command for returning to the position of pre-manual operation is sent to the axis specified as AXIS of the embedded positioning.
- (2) When the position is changed by manual operation after positioning, the command can be used to return to the position of pre-manual operation.
- (3) In AXIS, you can set up the axis to command and select one among 1~4. If the values other than set ones are selected, "error 6" will occur.

6.7 Function block related to synchronous operation

6.7.1 Position synchronization (XPM_SSP)

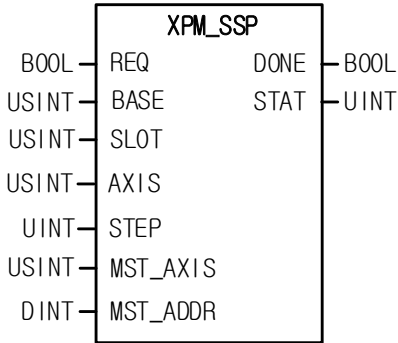
Function Block Type	Details
	<p>Input</p> <p>REQ : Request for executing function blocks</p> <p>BASE : Setting up the numbers of the bases where modules are equipped</p> <p>SLOT : Setting up the numbers of slots where modules are equipped</p> <p>AXIS : Specifying the axis to give commands 1 ~ 4: 1axis ~ 4axis</p> <p>STEP : Step No. to operate 0 ~ 400</p> <p>MST_AXIS : Setting position synchronization of the major axis 1 ~ 4: 1 ~ 4axis, 9: encoder</p> <p>MST_ADDR : Setting the position of the major axis to perform position synchronization -2,147,483,648 ~ 2,147,483,647</p> <p>Output</p> <p>DONE : Keeping 1 after the initial operation</p> <p>STAT : Outputting error No. that occurred during executing function blocks</p>

- (1) The command for position synchronization is sent to the axis specified as AXIS of the embedded positioning.
- (2) The axis that gives command is regarded as the minor axis. When the axis set as the major axis reaches the established synchronized position, the operation step set by the command axis will run.
- (3) In AXIS, you can set up the axis to command based on the below setting range. If the values other than set ones are selected, "error 6" will occur.

Setting range : 1 ~ 4(1axis ~ 4axis)

- (4) In MST_AXIS, you can set up the major axis of position synchronization among the below range. If the values other than set ones are selected, "error 11" will occur.

Setting range : 1 ~ 4(1axis ~ 4axis), 9(encoder)

6.7.2 Speed synchronization (XPM_SSS)

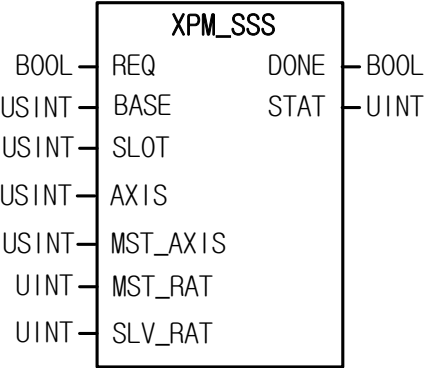
Function Block Type	Details
	<p>Input</p> <p>REQ : Request for executing function blocks</p> <p>BASE : Setting up the numbers of the bases where modules are equipped</p> <p>SLOT : Setting up the numbers of slots where modules are equipped</p> <p>AXIS : Specifying the axis to give commands 1 ~ 4: 1axis ~ 4axis</p> <p>MST_AXIS : Setting the major axis for speed synchronization 1 ~ 4: 1axis ~ 4axis, 9: encoder</p> <p>MST_RAT : Setting the major axis's speed ratio -32768 ~ 32767</p> <p>SLV_RAT : Setting the minor axis's speed ratio -32768 ~ 32767</p> <p>Output</p> <p>DONE : Keeping 1 after the initial operation</p> <p>STAT : Outputting error No. that occurred during executing function blocks</p>

- (1) The command for speed synchronization is sent to the axis specified as AXIS of the embedded positioning.
- (2) It is used to control the operating speed between two axes at the set ratio.
- (3) There is no rule about the size between the major axis's speed ratio and the minor axis's speed ratio. Namely, if the major axis's speed ratio is bigger than the minor axis's speed ratio, the major axis moves faster than the minor axis; if the minor axis's speed ratio is bigger than the major axis's speed ratio, the minor axis moves faster than the major axis.
- (4) In AXIS, you can set up the axis to command based on the below setting range. If the values other than set ones are selected, "error 6" will occur.
Setting range : 1 ~ 4(1axis ~ 4axis)
- (5) In MST_AXIS, you can set up the major axis of speed synchronization among the below range. If the values other than set ones are selected, "error 11" will occur.
Setting range : 1 ~ 4(1axis ~ 4axis), 9(encoder)
- (6) In terms of the minor axis' operating direction, if the speed synchronization ratio(minor axis ratio/major axis ratio) is a positive number, it runs in the same direction of major axis; if the speed synchronization ratio(minor axis ratio/major axis ratio) is a negative number, it runs in the opposite direction of the major axis.

6.7.3 Positioning speed synchronization(XPM_SSSP)

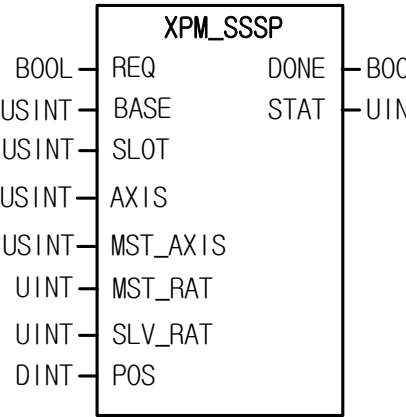
Function Block Type	Details
	<p>Input</p> <p>REQ : Request for executing function blocks</p> <p>BASE : Setting up the numbers of the bases where modules are equipped</p> <p>SLOT : Setting up the numbers of slots where modules are equipped</p> <p>AXIS : Specifying the axis to give commands 1 ~ 4: 1axis ~ 4axis</p> <p>MST_AXIS : Setting the major axis for speed synchronization 1 ~ 4: 1axis ~ 4axis, 9: encoder</p> <p>MST_RAT : Setting the major axis's speed ratio -32768 ~ 32767</p> <p>SLV_RAT : Setting the minor axis's speed ratio -32768 ~ 32767</p> <p>POS : Target position -2,147,483,648 ~ 2,147,483,647</p> <p>Output</p> <p>DONE : Keeping 1 after the initial operation</p> <p>STAT : Outputting error No. that occurred during executing function blocks</p>

- (1) The command for positioning speed synchronization is sent to the axis specified as AXIS of the embedded positioning.
- (2) It is used to control the operating speed between two axes at the set ratio. If the minor axis's position reaches the point set by POS, it will stop after finishing speed synchronization.
- (3) There is no rule about the size between the major axis's speed ratio and the minor axis's speed ratio. Namely, if the major axis's speed ratio is bigger than the minor axis's speed ratio, the major axis moves faster than the minor axis; if the minor axis's speed ratio is bigger than the major axis's speed ratio, the minor axis moves faster than the major axis.
- (4) In AXIS, you can set up the axis to command based on the below setting range. If the values other than set ones are selected, "error 6" will occur.
setting range : 1 ~ 4(1axis ~ 4axis)
- (5) In MST_AXIS, you can set up the major axis of speed synchronization among the below range. If the values other than set ones are selected, "error 11" will occur.
setting range : 1 ~ 4(1axis ~ 4axis), 9(encoder)
- (6) In terms of the minor axis' operating direction, if the speed synchronization ratio(minor axis ratio/major axis ratio) is a positive number, it runs in the same direction of major axis; if the speed synchronization ratio(minor axis ratio/major axis ratio) is a negative number, it runs in the opposite direction of the major axis.

6.7.4 CAM Operation(XPM_CAM)

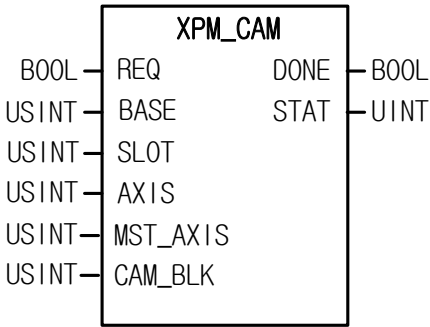
Function Block Type	Details
	<p>Input</p> <p>REQ : Request for executing function blocks</p> <p>BASE : Setting up the numbers of the bases where modules are equipped</p> <p>SLOT : Setting up the numbers of slots where modules are equipped</p> <p>AXIS : Specifying the axis to give commands 1 ~ 4: 1axis ~ 4axis</p> <p>MST_AXIS : Setting the major axis 1 ~ 4: 1axis ~ 4axis, 9: encoder</p> <p>CAM_BLK : Setting CAM blocks 1 ~ 8: 1block ~ 8block</p> <p>Output</p> <p>DONE : Keeping 1 after the initial operation</p> <p>STAT : Outputting error No. that occurred during executing function blocks</p>

- (1) The CAM operation command is sent to the axis specified as AXIS of the embedded positioning.
- (2) The command performs CAM operation for the relevant axis by using CAM major axis and CAM data blocks.
- (3) When executing the CAM operation command, although the minor axis (one set in AXIS) is displayed as 'During Operation', the motor actually does not run. When the axis set as the major one starts up, the motor starts running to the position of the minor axis corresponding to the major axis's position based on CAM data blocks' values set in CAM block (CAM_BLK).
- (4) In AXIS, you can set up the axis to command based on the below setting range. If the values other than set ones are selected, "error6" will occur.
Setting range : 1 ~ 4(1axis ~ 4axis)
- (5) In MST_AXIS, you can set up the major axis of CAM operation among the below range. If the values other than set ones are selected, "error 11" will occur.
Setting range : 1 ~ 4(1axis ~ 4axis), 9(encoder)
- (6) In CAM_BLK, you can set up the CAM block No. to run among the below range. If the values other than set ones are selected, "error 11" will occur.
Setting range : 1 ~ 8(block1 ~ block8)
- (7) You can set up CAM data in the positioning package with the maximum of 7 blocks.
- (8) To use User CAM Operation, set the CAM block No. as 8.
- (9) In the case of User CAM Operation, even during operation, you can change the user CAM data with the command for writing variable data
- (10) For more details on User CAM Operation, refer to "8.4.4 User CAM Operation".

6.7.5 CAM Operation with specifying the major axis's offset(XPM_CAMO)

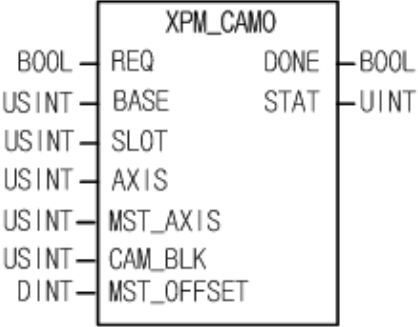
Function Block Type	Details
	<p>Input</p> <p>REQ : Request for executing function blocks</p> <p>BASE : Setting up the numbers of the bases where modules are equipped</p> <p>SLOT : Setting up the numbers of slots where modules are equipped</p> <p>AXIS : Specifying the axis to give commands 1 ~ 4: 1axis ~ 4axis</p> <p>MST_AXIS : Setting the major axis 1 ~ 4: 1axis ~ 4axis, 9: encoder</p> <p>CAM_BLK : Setting CAM block 1 ~ 8: 1block ~ 8block</p> <p>MST_OFFSET : Setting the travel amount of the major axis's offset position -2147483648 ~ 2147483647</p> <p>Output</p> <p>DONE : Keeping 1 after the initial operation</p> <p>STAT : Outputting error No. that occurred during executing function blocks</p>

- (1) The CAM operation command is sent to the axis specified as AXIS of the embedded positioning.
- (2) The command performs CAM operation for the relevant axis by using CAM major axis and CAM data blocks.
- (3) When executing the CAM operation command, although the minor axis (one set in AXIS) is displayed as 'During Operation', the motor actually does not run. After the axis set as the major one starts up and it moves as far as the travel amount of the major axis's offset position, the motor starts running to the position of the minor axis corresponding to the major axis's position based on CAM data blocks' values set in CAM block (CAM_BLK).
- (4) In AXIS, you can set up the axis to command based on the below setting range. If the values other than set ones are selected, "error6" will occur.
Setting range : 1 ~ 4(1axis ~ 4axis)
- (5) In MST_AXIS, you can set up the major axis of CAM operation among the below range. If the values other than set ones are selected, "error 11" will occur.
Setting range : 1 ~ 4(1axis ~ 4axis), 9(encoder)
- (6) In CAM_BLK, you can set up the CAM block No. to run among the below range. If the values other than set ones are selected, "error 11" will occur.
Setting range : 1 ~ 8(block1 ~ block8)
- (7) You can set up CAM data in the positioning package with the maximum of 8 blocks(User CAM block: 1EA).

6.8 Function blocks related to changes

6.8.1 Position override (XPM_POR)

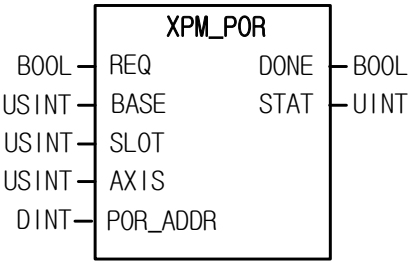
Function Block Type	Details
	<p>Input</p> <p>REQ : Request for executing function blocks</p> <p>BASE : Setting up the numbers of the bases where modules are equipped</p> <p>SLOT : Setting up the numbers of slots where modules are equipped</p> <p>AXIS : Specifying the axis to give commands 1 ~ 4: 1axis ~ 4axis</p> <p>POR_ADDR : Setting the new target position -2,147,483,648 ~ 2,147,483,647</p> <p>Output</p> <p>DONE : Keeping 1 after the initial operation</p> <p>STAT : Outputting error No. that occurred during executing function blocks</p>

- (1) The position override command is sent to the axis specified as AXIS of the embedded positioning.
- (2) It is used to change the target position while the command axis is running.
- (3) If you perform position override after passing the point for position override, it will stop at the current position and then, changes its direction and moves to the position set in POR_ADDR.
- (4) In POR_ADDR, you can set up the target position to change.
- (5) The value set for the position override is absolute coordinate position.
- (6) In AXIS, you can set up the axis to command based on the below setting range. If the values other than set ones are selected, "error6" will occur.
Setting range : 1 ~ 4(1axis ~ 4axis)

6.8.2 Speed override(XPM_SOR)

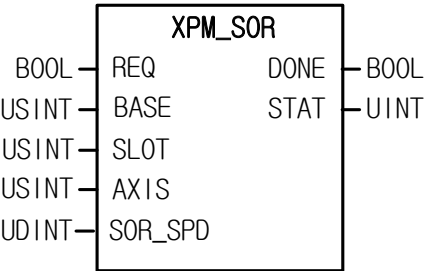
Function Block Type	Details
	<p>Input</p> <p>REQ : Request for executing function blocks</p> <p>BASE : Setting up the numbers of the bases where modules are equipped</p> <p>SLOT : Setting up the numbers of slots where modules are equipped</p> <p>AXIS : Specifying the axis to give commands 1 ~ 4: 1axis ~ 4axis</p> <p>SOR_SPD :Setting new operating speed value</p> <p>Output</p> <p>DONE : Keeping 1 after the initial operation</p> <p>STAT : Outputting error No. that occurred during executing function blocks</p>

- (1) The speed override command is sent to the axis specified as AXIS of the embedded positioning.
- (2) It is used to change the operating speed while the command axis is running.
- (3) SOR_SPD can be set as “%” or “speed value(unit/time)” based on the values set in “speed override” of the command parameters.
- (4) In case the unit of speed override value is %, the setting area is 1 ~ 65,535 that indicates 0.01% ~ 655.35%.
- (5) In case the unit of speed override value is speed value, the setting area is 1 ~ speed limit and at this time, the speed limit is the value set in “speed limit” of basic parameters. In addition, the unit of speed override value follows the axis’s unit.
- (6) In AXIS, you can set up the axis to command based on the below setting range. If the values other than set ones are selected, “error 6” will occur.

Setting range : 1 ~ 4(1axis ~ 4axis)

6.8.3 Positioning speed override(XPM_PSO)

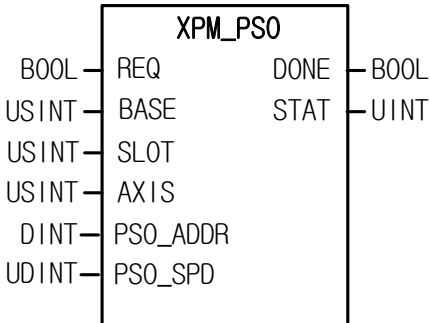
Function Block Type	Details
	<p>Input</p> <p>REQ : Request for executing function blocks</p> <p>BASE : Setting up the numbers of the bases where modules are equipped</p> <p>SLOT : Setting up the numbers of slots where modules are equipped</p> <p>AXIS : Specifying the axis to give commands 1 ~ 4: 1axis ~ 4axis</p> <p>PSO_ADDR : Position to change speed -2,147,483,648 ~ 2,147,483,647</p> <p>PSO_SPD : Setting the new operating speed value</p> <p>Output</p> <p>DONE : Keeping 1 after the initial operation</p> <p>STAT : Outputting error No. that occurred during executing function blocks</p>

- (1) The speed override command is sent to the axis specified as AXIS of the embedded positioning.
- (2) It is used to change the operating speed after reaching a certain position in the state that the command axis is running.
- (3) PSO_SPD can be set as “%” or “speed value(unit/time)” based on the values set in “speed override” of the command parameters.
- (4) In case the unit of speed override value is %, the setting area is 1 ~ 65,535 that indicates 0.01% ~ 655.35%.
- (5) In AXIS, you can set up the axis to command based on the below setting range. If the values other than set ones are selected, “error 6” will occur.
Setting range : 1 ~ 4(1axis ~ 4axis)

6.8.4 Position/speed switching control(XPM_PTV)

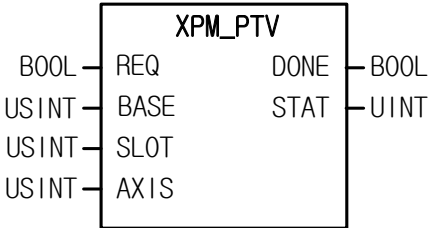
Function Block Type	Details
	<p>Input</p> <p>REQ : Request for executing function blocks</p> <p>BASE : Setting up the numbers of the bases where modules are equipped</p> <p>SLOT : Setting up the numbers of slots where modules are equipped</p> <p>AXIS : Specifying the axis to give commands 1 ~ 4: 1axis ~ 4axis</p> <p>Output</p> <p>DONE : Keeping 1 after the initial operation</p> <p>STAT : Outputting error No. that occurred during executing function blocks</p>

- (1) The command for switching position/speed control is sent to the axis specified as AXIS of the embedded positioning.
- (2) When the position/speed control switching command is given to the axis where position control operation was applied with the determined travel amount, the operation mode will be converted from position control into speed control. It will run until the factors of stoppage such as deceleration stop, etc occur.
- (3) When this command is executed, speed control will be applied with the undetermined origin.
- (4) In AXIS, you can set up the axis to command based on the below setting range. If the values other than set ones are selected, "error6" will occur.
Setting range : 1 ~ 4(1axis ~ 4axis)

6.8.5 Speed/position switching control(XPM_VTP)

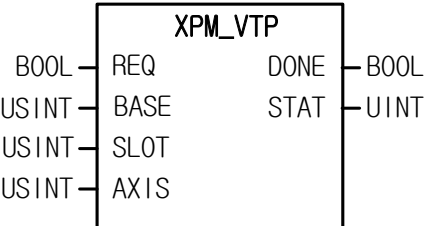
Function Block Type	Details
	<p>Input</p> <p>REQ : Request for executing function blocks</p> <p>BASE : Setting up the numbers of the bases where modules are equipped</p> <p>SLOT : Setting up the numbers of slots where modules are equipped</p> <p>AXIS : Specifying the axis to give commands 1 ~ 4: 1axis ~ 4axis</p> <p>Output</p> <p>DONE : Keeping 1 after the initial operation</p> <p>STAT : Outputting error No. that occurred during executing function blocks</p>

- (1) The command for switching speed/position control is sent to the axis specified as AXIS of the embedded positioning.
- (2) When the speed/position control switching command is given to the specified axis where speed operation was applied, the operation mode will be converted from speed control into position control and positioning operation will run with the position value set when starting speed control.
- (3) In AXIS, you can set up the axis to command based on the below setting range. If the values other than set ones are selected, "error6" will occur.
Setting range : 1 ~ 4(1axis ~ 4axis)

6.8.6 Positioning speed/position switching control(XPM_VTPP)

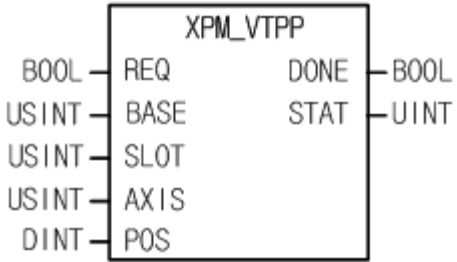
Function Block Type	Details
	<p>Input</p> <p>REQ : Request for executing function blocks</p> <p>BASE : Setting up the numbers of the bases where modules are equipped</p> <p>SLOT : Setting up the numbers of slots where modules are equipped</p> <p>AXIS : Specifying the axis to give commands 1 ~ 4: 1axis ~ 4axis</p> <p>POS : Travel amount of position -2,147,483,648 ~ 2,147,483,647</p> <p>Output</p> <p>DONE : Keeping 1 after the initial operation</p> <p>STAT : Outputting error No. that occurred during executing function blocks</p>

- (1) The positioning speed/position switching command is sent to the axis specified as AXIS of the embedded positioning.
- (2) When the positioning speed/position switching command is given to the specified axis where speed control operation was applied, the operation mode will be converted from speed control into position control and then, positioning operation will run as far as the position travel amount set in POS.
- (3) In AXIS, you can set up the axis to command based on the below setting range. If the values other than set ones are selected, "error6" will occur.
Setting range : 1 ~ 4(1axis ~ 4axis)

6.8.7 Skip Operation (XPM_SKP)

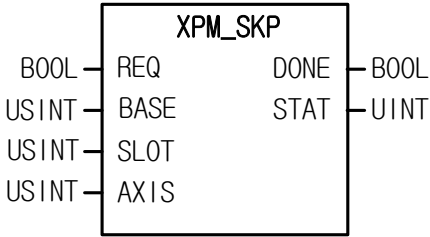
Function Block Type	Details
	<p>Input</p> <p>REQ : Request for executing function blocks</p> <p>BASE : Setting up the numbers of the bases where modules are equipped</p> <p>SLOT : Setting up the numbers of slots where modules are equipped</p> <p>AXIS : Specifying the axis to give commands 1 ~ 4: 1axis ~ 4axis</p> <p>Output</p> <p>DONE : Keeping 1 after the initial operation</p> <p>STAT : Outputting error No. that occurred during executing function blocks</p>

- (1) The command for skip operation is sent to the axis specified as AXIS of the embedded positioning.
 - (2) It is used to move to the next step without running the operation step. Namely, it stops and terminates the current operating step and continues the operation with the next step.
 - (3) Each time you run this command, it will skip the current operating step and move to the next one.
 - (4) In AXIS, you can set up the axis to command based on the below setting range. If the values other than set ones are selected, "error 6" will occur.
- Setting range : 1 ~ 4(1axis ~ 4axis)

6.8.8 Continuous operation(XPM_NMV)

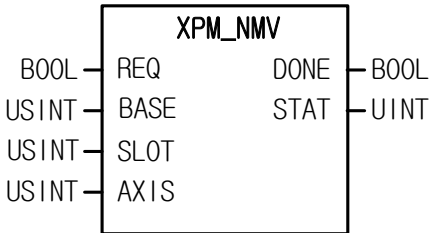
Function Block Type	Details
	<p>Input</p> <p>REQ : Request for executing function blocks</p> <p>BASE : Setting up the numbers of the bases where modules are equipped</p> <p>SLOT : Setting up the numbers of slots where modules are equipped</p> <p>AXIS : Specifying the axis to give commands 1 ~ 4: 1axis ~ 4axis</p> <p>Output</p> <p>DONE : Keeping 1 after the initial operation</p> <p>STAT : Outputting error No. that occurred during executing function blocks</p>

- (1) The command for continuous operation is sent to the axis specified as AXIS of the embedded positioning.
- (2) It is used to move to the next operating step without stopping the command axis in the currently operating step.
- (3) When the continuous operation command is executed, the currently operating step No. is changed into the next step No. and position operation will proceed with the next step's speed and target position. The connection with the next step is performed by the continuous operation pattern.
- (4) The continuous operation command changes the operation pattern of the currently running step only and does not change the operation data.
- (5) In AXIS, you can set up the axis to command based on the below setting range. If the values other than set ones are selected, "error6" will occur.
Setting range : 1 ~ 4(1axis ~ 4axis)

6.8.9 Change of start-up step (XPM_SNS)

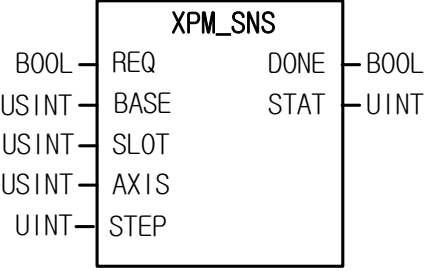
Function Block Type	Details
	<p>Input</p> <p>REQ : Request for executing function blocks</p> <p>BASE : Setting up the numbers of the bases where modules are equipped</p> <p>SLOT : Setting up the numbers of slots where modules are equipped</p> <p>AXIS : Specifying the axis to give commands 1 ~ 4: 1axis ~ 4axis</p> <p>STEP : Setting the operation step No. to run 1 ~ 400</p> <p>Output</p> <p>DONE : Keeping 1 after the initial operation</p> <p>STAT : Outputting error No. that occurred during executing function blocks</p>

- (1) The command to change start-up step is sent to the axis specified as AXIS of the embedded positioning.
- (2) It is used to change the operation step of the command axis.
- (3) In AXIS, you can set up the axis to command based on the below setting range. If the values other than set ones are selected, "error 6" will occur.
Setting range : 1 ~ 4(1axis ~ 4axis)
- (4) In STEP, you can set up the step No. to start the repetitive operation. The range of set values is 1 ~ 400 and if the values other than set ones are selected, "error 11" will occur.

6.8.10 Change of repetitive step No. (XPM_SRS)

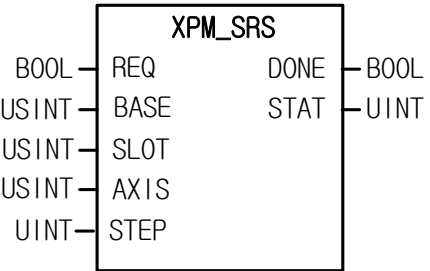
Function Block Type	Details
	<p>Input</p> <p>REQ : Request for executing function blocks</p> <p>BASE : Setting up the numbers of the bases where modules are equipped</p> <p>SLOT : Setting up the numbers of slots where modules are equipped</p> <p>AXIS : Specifying the axis to give commands 1 ~ 4: 1axis ~ 4axis</p> <p>STEP : Setting the repetitive step No. to change 1 ~ 400</p> <p>Output</p> <p>DONE : Keeping 1 after the initial operation</p> <p>STAT : Outputting error No. that occurred during executing function blocks</p>

- (1) The command to change repetitive step is sent to the axis specified as AXIS of the embedded positioning.
- (2) The command is used to start the operation in a certain operating step by specifying the start step No. of repetitive operation when running the repetitive operation that the command is given during running with the operation data, it returns to the repetitive operation step.
- (3) In AXIS, you can set up the axis to command based on the below setting range. If the values other than set ones are selected, "error 6" will occur.
Setting range : 1 ~ 4(1axis ~ 4axis)
- (4) In STEP, you can set up the step No. to start the repetitive operation. The range of set values is 1 ~ 400 and if the values other than set ones are selected, "error 11" will occur.

6.8.11 Change of the current position (XPM_PRS)

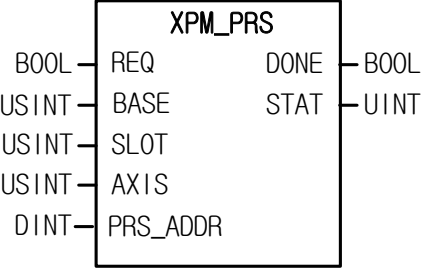
Function Block Type	Details
	<p>Input</p> <p>REQ : Request for executing function blocks</p> <p>BASE : Setting up the numbers of the bases where modules are equipped</p> <p>SLOT : Setting up the numbers of slots where modules are equipped</p> <p>AXIS : Specifying the axis to give commands 1 ~ 4: 1axis ~ 4axis</p> <p>PRS_ADDR : Setting the current position value to change -2,147,483,648 ~ 2,147,483,647</p> <p>Output</p> <p>DONE : Keeping 1 after the initial operation</p> <p>STAT : Outputting error No. that occurred during executing function blocks</p>

- (1) The command to preset the current position is sent to the axis specified as AXIS of the embedded positioning.
- (2) The command is used to change the current position into an arbitrary position. If it is executed with the undetermined origin, the signal for determining the origin will be On and the current position will be changed into the set value (PRS_ADDR).
- (3) In AXIS, you can set up the axis to command based on the below setting range. If the values other than set ones are selected, "error 6" will occur.
Setting range : 1 ~ 4(1axis ~ 4axis)

6.8.12 Encoder Value Preset (XPM_EPRES)

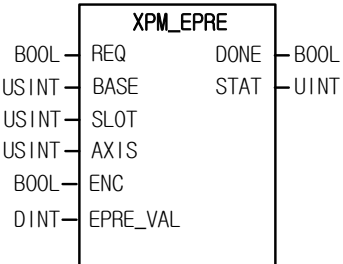
Function Block Type	Details
	<p>Input</p> <p>REQ : Request for executing function blocks</p> <p>BASE : Setting up the numbers of the bases where modules are equipped</p> <p>SLOT : Setting up the numbers of slots where modules are equipped</p> <p>AXIS : Specifying the axis to give commands 1 ~ 4: 1axis ~ 4axis</p> <p>ENC : encoder No. (Set as 0 all the time) 0: encoder</p> <p>EPRES_VAL : Setting the encoder's preset value (Encoder's min. value ~ Encoder's max value-1)</p> <p>Output</p> <p>DONE : Keeping 1 after the initial operation</p> <p>STAT : Outputting error No. that occurred during executing function blocks</p>

- (1) The encoder preset command is sent to the axis specified as AXIS of the embedded positioning.
- (2) The command changes the encoder's current value into the set value of EPRES_VAL.
- (3) In ENC, you can set up the encoder to preset and the value should always be set as 0 in embedded positioning module. If you have the values other than 0, "error11" will occur.
- (4) In AXIS, you can set up the axis to command based on the below setting range. If the values other than set ones are selected, "error 6" will occur.

Setting range : 1 ~ 4(1axis ~ 4axis)

6.9 Function blocks related errors

6.9.1 Error reset(XPM_RST)

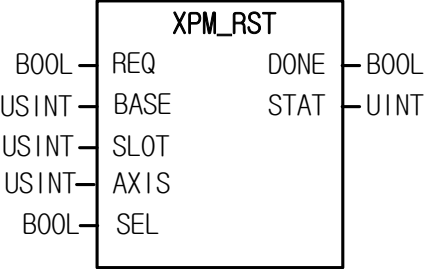
Function Block Type	Details
	<p>Input</p> <p>REQ : Request for executing function blocks BASE : Setting up the numbers of the bases where modules are equipped SLOT : Setting up the numbers of slots where modules are equipped AXIS : Specifying the axis to give commands 1 ~ 4: 1axis ~ 4axis SEL : Selecting axis error/common error 0: axis error (Set as 0 all the time)</p> <p>Output</p> <p>DONE : Keeping 1 after the initial operation STAT : Outputting error No. that occurred during executing function blocks</p>

- (1) The error reset command is sent to the axis specified as AXIS of the embedded positioning.
- (2) In AXIS, you can set up the axis to command based on the below setting range. If the values other than set ones are selected, "error 6" will occur.
Setting range : 1 ~ 4(1axis ~ 4axis)
- (3) When parameters exceed the setting range or errors occur during operation, the command is used to reset the errors.
- (4) In SEL, you can select the error type to reset. If the value is "0", the error occurred in the command axis of each axis will be reset. In X□C-DN32UP's embedded positioning, the value should be set as "0" all the time.

6.9.2 Error history reset(XPM_HRST)

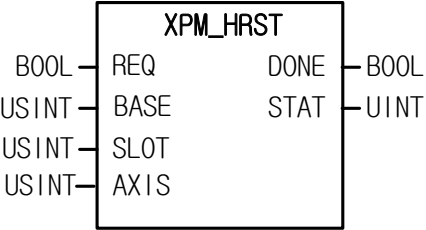
Function Block Type	Details
	<p>Input</p> <p>REQ : Request for executing function blocks</p> <p>BASE : Setting up the numbers of the bases where modules are equipped</p> <p>SLOT : Setting up the numbers of slots where modules are equipped</p> <p>AXIS : Specifying the axis to give commands 1 ~ 4: 1axis ~ 4axis</p> <p>Output</p> <p>DONE : Keeping 1 after the initial operation</p> <p>STAT : Outputting error No. that occurred during executing function blocks</p>

- (1) The command to reset error history is sent to the axis specified as AXIS of the embedded positioning.
- (2) In AXIS, you can set up the axis to command based on the below setting range. If the values other than set ones are selected, "error 6" will occur.
Setting range : 1 ~ 4(1axis ~ 4axis)
- (3) When parameters exceed the setting range or errors occur during operation, it saves the errors to the module up to 10. The command is used to reset the error history.

6.10 Function blocks related errors

6.10.1 Setting the floating origin point (XPM_FLT)

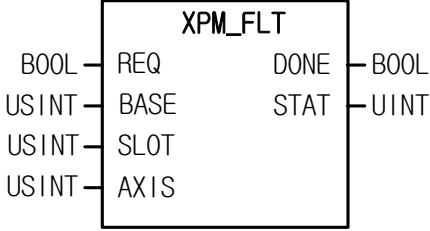
Function Block Type	Details
	<p>Input</p> <p>REQ : Request for executing function blocks</p> <p>BASE : Setting up the numbers of the bases where modules are equipped</p> <p>SLOT : Setting up the numbers of slots where modules are equipped</p> <p>AXIS : Specifying the axis to give commands 1 ~ 4: 1axis ~ 4axis</p> <p>Output</p> <p>DONE : Keeping 1 after the initial operation</p> <p>STAT : Outputting error No. that occurred during executing function blocks</p>

- (1) The command for setting the floating origin point is sent to the axis specified as AXIS of the embedded positioning.
- (2) The command is used when you want to set up forcibly the current position as the origin without homing operation of the machine. In this case, the address value specified in the homing address will be the current position.
- (3) In AXIS, you can set up the axis to command based on the below setting range. If the values other than set ones are selected, "error 6" will occur.

Setting range : 1 ~ 4(1axis ~ 4axis)

6.10.2 Clearing M code (XPM_MOF)

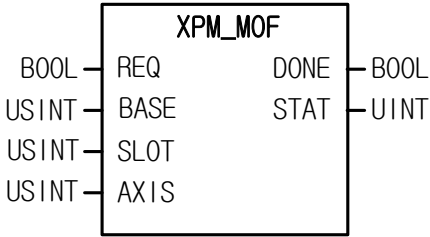
Function Block Type	Details
	<p>Input</p> <p>REQ : Request for executing function blocks</p> <p>BASE : Setting up the numbers of the bases where modules are equipped</p> <p>SLOT : Setting up the numbers of slots where modules are equipped</p> <p>AXIS : Specifying the axis to give commands 1 ~ 4: 1axis ~ 4axis</p> <p>Output</p> <p>DONE : Keeping 1 after the initial operation</p> <p>STAT : Outputting error No. that occurred during executing function blocks</p>

- (1) The command for clearing M code is sent to the axis specified as AXIS of the embedded positioning.
 - (2) In case the M code is set as 'With' or 'After Mode' in each axis's parameters, when the command axis's M code signal is On, it can be used to turn Off this signal. Namely, it changes the M code signal into Off and M code No. into On.
 - (3) In AXIS, you can set up the axis to command based on the below setting range. If the values other than set ones are selected, "error 6" will occur.
- Setting range : 1 ~ 4(1axis ~ 4axis)

6.11 Function blocks related to Servo Drive

6.11.1 Servo-On(XPM_SVON)

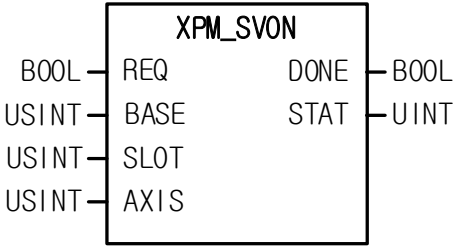
Function Block Type	Details
	<p>Input</p> <p>REQ : Request for executing function blocks</p> <p>BASE : Setting up the numbers of the bases where modules are equipped</p> <p>SLOT : Setting up the numbers of slots where modules are equipped</p> <p>AXIS : Specifying the axis to give commands 1 ~ 4: 1axis ~ 4axis</p> <p>Output</p> <p>DONE : Keeping 1 after the initial operation</p> <p>STAT : Outputting error No. that occurred during executing function blocks</p>

- (1) The Servo-On signal is sent to the axis set as AX of the positioning module that is designated as BASE(positioning module's base No., fixed as No.0) and SLOT(positioning module's slot No., XEC embedded positioning is fixed as No. 1).
- (2) Among Servos connected to modules, the Servo-On signal is generated in the Servo corresponding on the selected axis.
- (3) In AXIS, you can set up the axis to command based on the below setting range. If the values other than set ones are selected, "error 6" will occur.
Setting range : 1 ~ 4(1axis ~ 4axis)

6.11.2 Servo-Off(XPM_SVOFF)

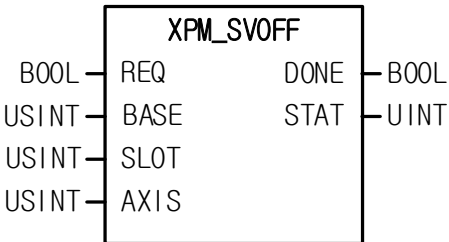
Function Block Type	Details
	<p>Input</p> <p>REQ : Request for executing function blocks</p> <p>BASE : Setting up the numbers of the bases where modules are equipped</p> <p>SLOT : Setting up the numbers of slots where modules are equipped</p> <p>AXIS : Specifying the axis to give commands 1 ~ 4: 1axis ~ 4axis</p> <p>Output</p> <p>DONE : Keeping 1 after the initial operation</p> <p>STAT : Outputting error No. that occurred during executing function blocks</p>

(1) The Servo-Off signal is sent to the axis set as AX of the positioning module that is designated as BASE(positioning module's base No., fixed as No.0) and SLOT(positioning module's slot No., XEC embedded positioning is fixed as No. 1).

(2) Among Servos connected to modules, the Servo-Off signal is generated in the Servo corresponding on the selected axis.

(3) In AXIS, you can set up the axis to command based on the below setting range. If the values other than set ones are selected, "error 6" will occur.

Setting range : 1 ~ 4(1axis ~ 4axis)

6.11.3 Servo error reset(XPM_SRST)

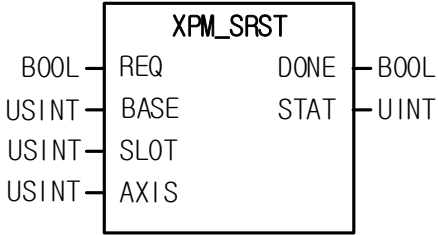
Function Block Type	Details
	<p>Input</p> <p>REQ : Request for executing function blocks</p> <p>BASE : Setting up the numbers of the bases where modules are equipped</p> <p>SLOT : Setting up the numbers of slots where modules are equipped</p> <p>AXIS : Specifying the axis to give commands 1 ~ 4: 1axis ~ 4axis</p> <p>Output</p> <p>DONE : Keeping 1 after the initial operation</p> <p>STAT : Outputting error No. that occurred during executing function blocks</p>

- (1) The signal to reset Servo error is sent to the axis set as AX of the positioning module that is designated as BASE(positioning module's base No., fixed as No.0) and SLOT(positioning module's slot No., XEC embedded positioning is fixed as No. 1).
- (2) Among Servos connected to modules, the Servo-On signal is generated in the Servo corresponding on the selected axis.
- (3) In case the command to reset Servo error is given without removing causes of the Servo Drive's alarms, the alarms may not be cleared. Therefore, after removing the causes of alarms, perform the command.
- (4) In AXIS, you can set up the axis to command based on the below setting range. If the values other than set ones are selected, "error6" will occur.
Setting range : 1 ~ 4(1axis ~ 4axis)

Chapter 7 Program

Here we supposed the positioning Module is installed at the 3 slot of the 0 base. In the real usage, you need to change its value according to your actual set up.

7.1 Example of Programming

7.1.1 General description

In this chapter, all program are XPM positioning module. (1th slot is fixed for positioning in XEC-DN32UP)
Many examples are using 1,2axis for convenience. User can change the device when needed

7.1.2 Current State Read

(1) Bit Information about Operation state Reading (XPM_SRD)

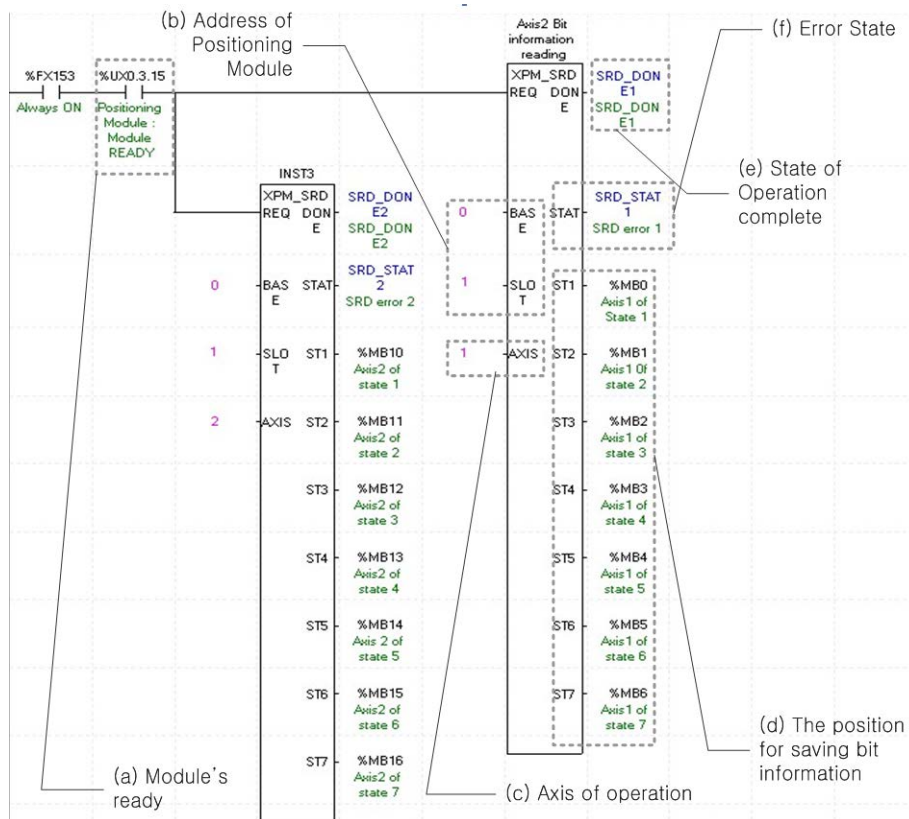

(d) The position for saving bit information

Set the device to save bit state value of axis from the APM module with XPM_SRD. This device is available to be used in sequence program as a condition. For example, the current bit state in the example program above is saved in %MB0 ~ % MB6. For the detail description about the device saved, refer to “7.3.2 Current Operation State Bit Information Reading”. Bit information which saved in a device is available to be used to execute another command. For example, if you need to use In-operation-signal of axis1, just set as %MB0.0. If you need to use Error-state of axis2, just set %MB10.1.

(e) State of Operation complete

If function block is completed without error, “1” will be outputted and maintain “1” until the next operation. If error occurred, “0” will be outputted.

(f) Error State

This is the area that output error no. if there are errors in operation of function block.

(2) Current Operation Information Reading

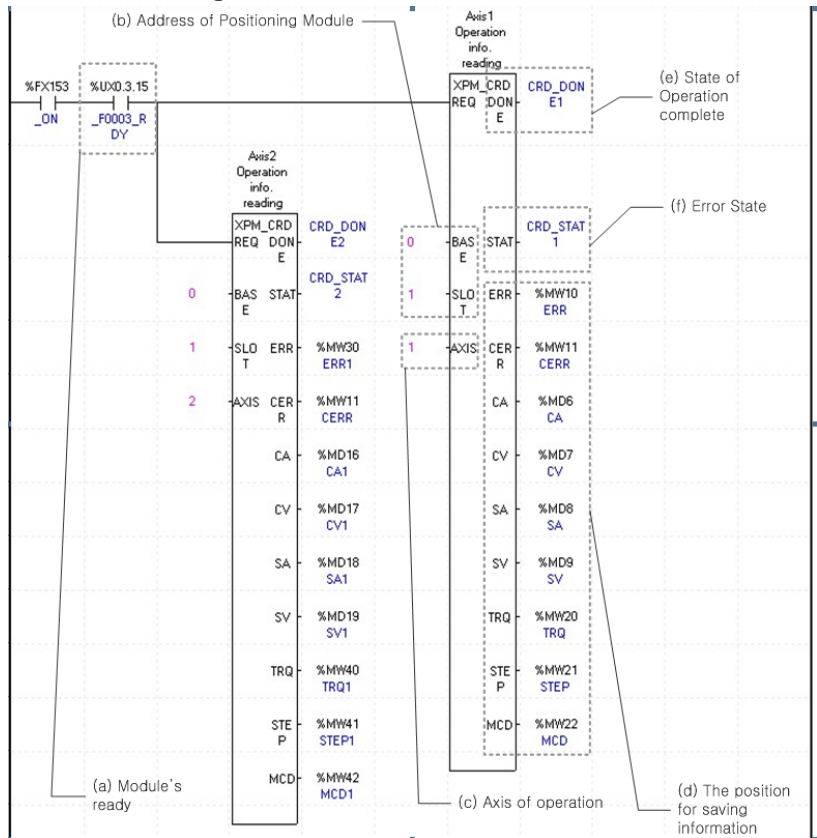

(a) Module's ready

After Turn On, if there is no error occurred in Positioning Module, it is “ON,” meaning that modules are ready to operate.

(b) Address of Positioning Module

In this example, Positioning Module is fixed at the 1 slot of 0 bases.

(c) Axis of operation

If you command each axis, need to set Axis of command execution. UP type can control max. 4 axes, Axis of command execution1~4 means axis1~axis4.

(d) The position for saving operation information

Set the device to save operation state value of axis from the APM module with XPM_CRD. This device is available to be used in sequence program as a monitoring value. For example, the current position value of axis1 in the example

program above is saved in %MD8. For the detail description about the device saved, refer to “7.3.1 Operation Information Reading (XPM_CRD)”.

(e) State of Operation complete

If function block is completed without error, “1” will be outputted and maintain “1” until the next operation. If error occurred, “0” will be outputted.

(f) Error State

This is the area that output error no. if there are errors in operation of function block.

(3) Encoder value Reading

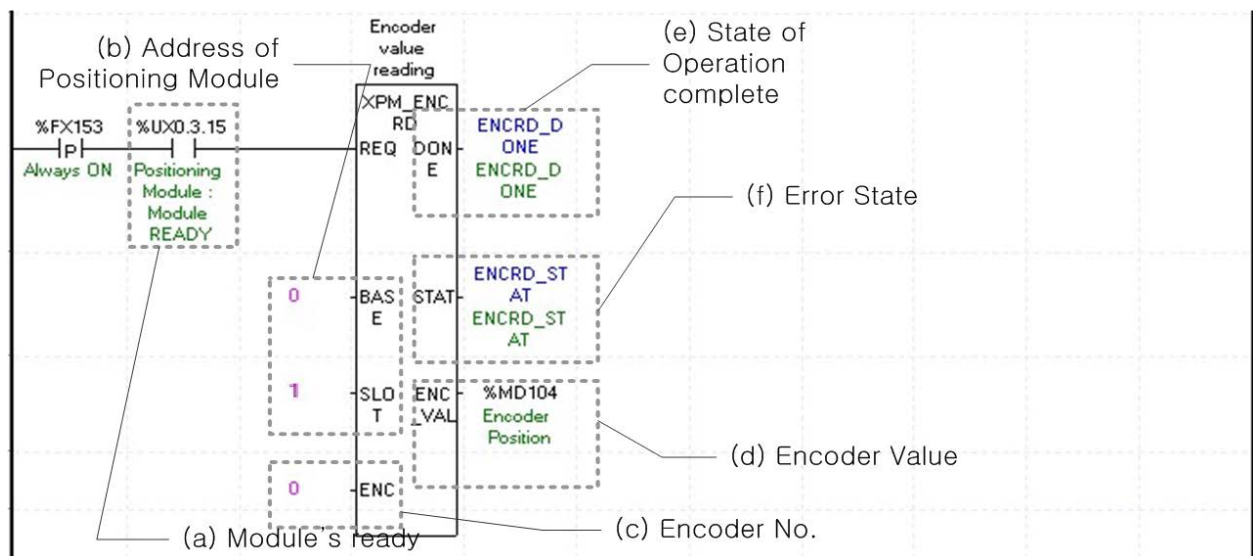

(a) Module's ready

After Turn On, if there is no error occurred in Positioning Module, it is “ON,” meaning that modules are ready to operate.

(b) Address of Positioning Module

In this example, Positioning Module is fixed at the 1 slot of 0 bases.

(c) Encoder No.

Set the encoder no. to read encoder value. UP type must be set as 0.

(d) Encoder value

The current value of encoder is displayed.

(e) State of Operation complete

If function block is completed without error, “1” will be outputted and maintain “1” until the next operation. If error occurred, “0” will be outputted.

(f) Error State

This is the area that output error no. if there are errors in operation of function block.

7.1.3 Operation Test

(1) Floating Origin Setting

Decide origin of current motor's position without set a machinery origin.

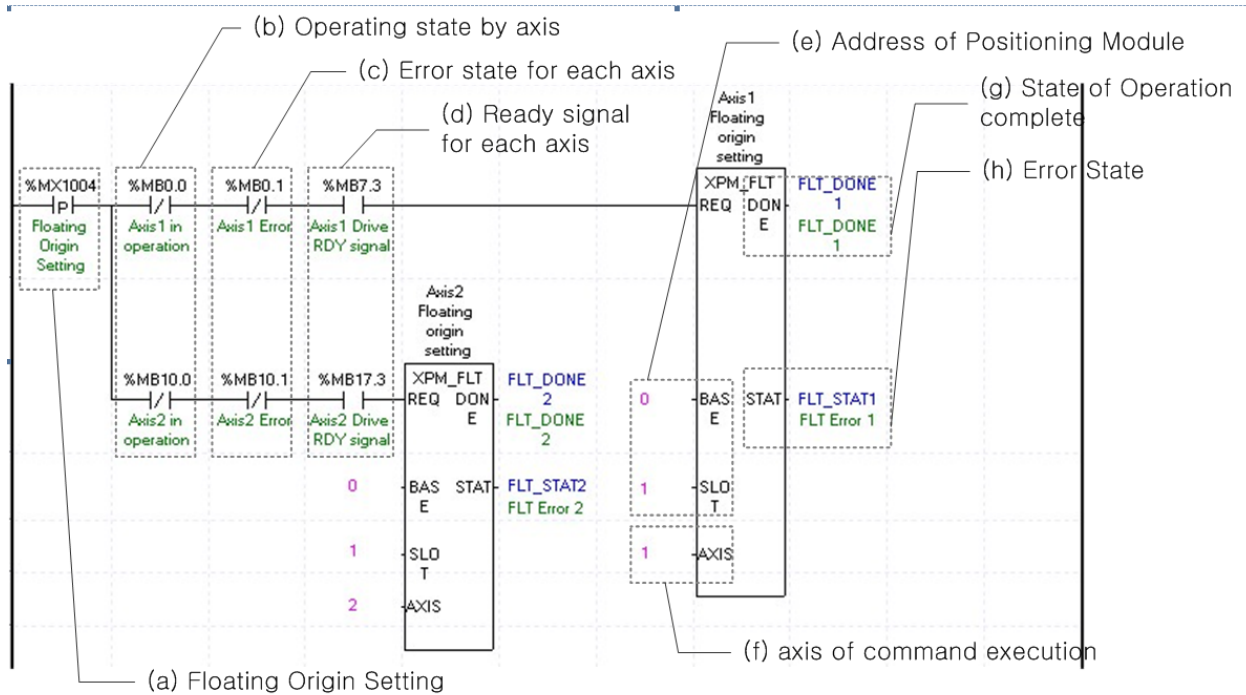

- (a) This is the condition for running a Floating Origin Setting
It only works with XFLT command.
- (b) Operating state by axis
According to exercise from "Chapter 7.1.2 Current State Reading," it is a signal of "Operating" for each axis.
- (c) Error state for each axis
According to exercise from "Chapter 7.1.2 Current State Reading," it is a signal of "Error state" for each axis. It turns on when an error occurred. Operation will only work when there is no error. If you want to operate a system regardless of errors, you can just inactivate the function.
- (d) Ready signal for each axis
According to exercise from "Chapter 7.1.2 Current State Reading," it is a signal of "Drive Ready" for each axis. This command only works when this is the condition for Floating Origin Setting is on. If it is not set as "ON," the "error 212" would be appeared.
- (e) Address of Positioning Module
In this example, Positioning Module is fixed at the 1 slot of 0 bases.
- (f) Axis of command execution
You can set an axis for Floating Origin Setting. UP type supports for 4 axes. In the "execution of axis" from the configuration of Floating Origin Setting, you can set a value for axis1 through axis4
- (g) State of Operation complete
If function block is completed without error, "1" will be outputted and maintain "1" until the next operation. If error

occurred, "0" will be outputted.

(h) Error State

This is the area that output error no. if there are errors in operation of function block.

(2) Jog Operation

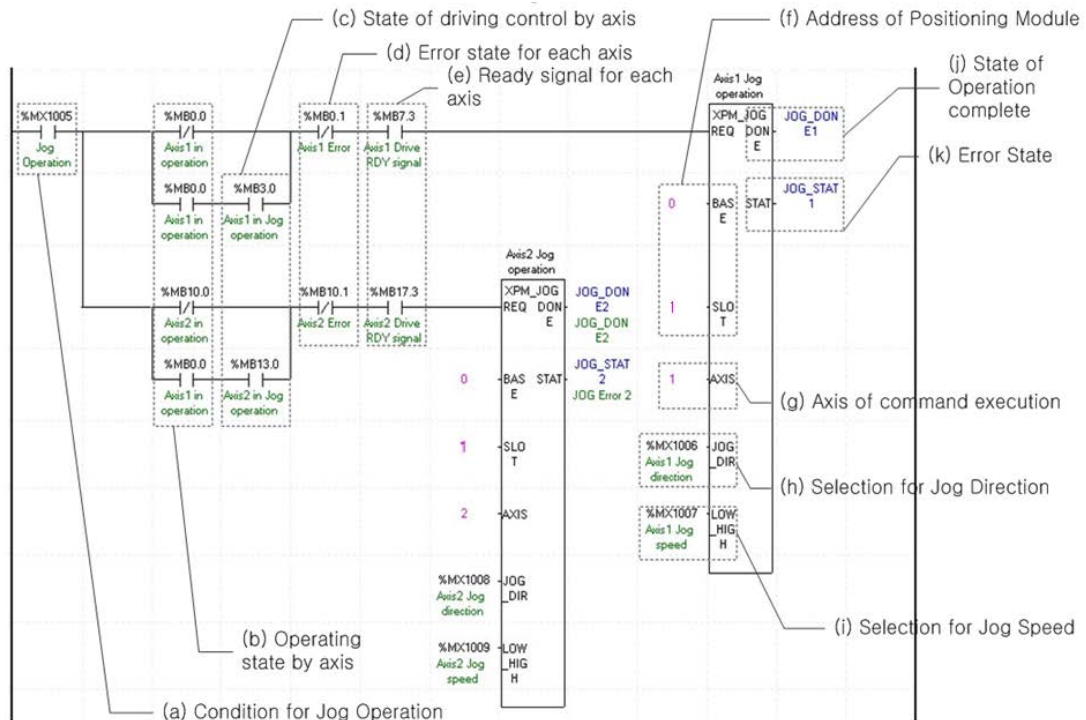

(a) This is the condition for Jog Operation

This is the condition for Jog Operation Command

(b) Operating state by axis

Jog Operation can only be working when the state of axis set as Jog Operation. In this example above, specific axis set as Jog Operation otherwise it is not operating.

(c) State of driving control by axis

According to exercise from "Chapter 7.1.2 Current State Reading," it is a signal of "Jog Operating" for each axis. It turns on when it is operating. Jog Operation configuration can be changed while it is operating.

(d) Error state for each axis

According to exercise from "Chapter 7.1.2 Current State Reading," it is a signal of "Error state" for each axis. It turns on when an error occurred. Operation will only work when there is no error. If you want to operate a system regardless of errors, you can just inactivate the function.

(e) Ready signal for each axis

According to exercise from "Chapter 7.1.2 Current State Reading," it is a signal of "Drive Ready" for each axis. This command only works when this is the condition for Jog Operation is on. If it is not set as "ON," the "error 413" would be appeared.

(f) Address of Positioning Module

In this example, Positioning Module is fixed at the 1 slot of 0 bases.

You can set an axis for Inching Operation. UP type supports for 4 axes. In the “execution of axis” from the configuration of Inching Operation, you can set a value for axis1 through axis4.

(f) Amount of Inching Operation Movement

Measure the amount of moving range by Inching Operation.

(g) complete Operating Status

If function block is completed without error, “1” will be outputted and maintain “1” until the next operation. If error occurred, “0” will be outputted.

(h) Error Status

This is the area that output error no. if there are errors in operation of function block.

(4) Return to the position before Manual Operation

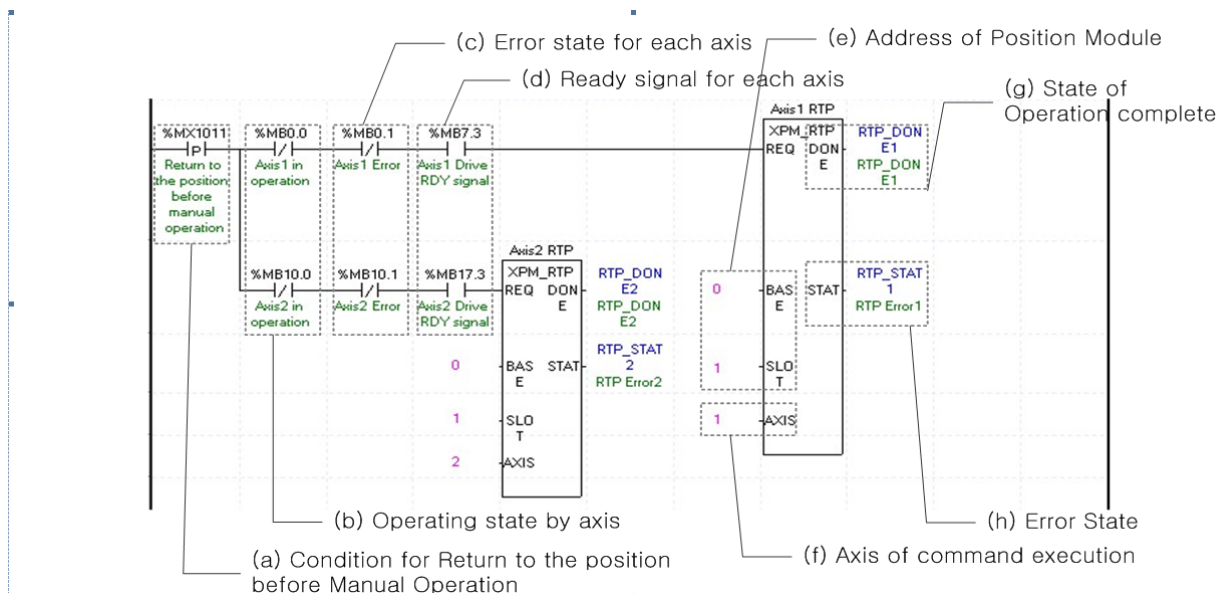

(a) This is the condition for Return to the position before Manual Operation

This is the condition for Return to the position before Manual Operation Command (XPM_RTP)

(b) Operating state by axis

According to exercise from “Chapter 7.1.2 Current State Reading,” it is a signal of “Manual Operating” for each axis. It turns on when it is operating. Inching Operation can not be configured while it is running hence configuration will only be configured when it is not running. If you execute Manual Operation while it is running, the “error 431” would be appeared.

(c) Error state for each axis

According to exercise from “Chapter 7.1.2 Current State Reading,” it is a signal of “Error state” for each axis. It turns on when an error occurred. Operation will only work when there is no error. If you want to operate a system regardless of errors, you can just inactivate the function.

(d) Ready signal for each axis

According to exercise from “Chapter 7.1.2 Current State Reading,” it is a signal of “Drive Ready” for each axis. This command only works when this is the condition for Manual Operation is on. If it is not set as “ON,” the “error 434” would be appeared.

(e) Address of Positioning Module

In this example, Positioning Module is fixed at the 1 slot of 0 bases.

(f) Axis of command execution

You can set an axis for Inching Operation. UP type supports for 4 axes. In the “execution of axis” from the configuration of Manual Operation, you can set a value for axis1 through axis4.

(g) State of Operation complete

If function block is completed without error, “1” will be outputted and maintain “1” until the next operation. If error occurred, “0” will be outputted.

(h) Error State

This is the area that output error no. if there are errors in operation of function block.

(i) When manual operation is running, the other operations are going back to its original position such as Jog Operation and Inching Operation. Reference for Manual Operation is from “Chapter 6.63 Return to the previous position of manual operation.”

7.1.4 Parameter and Operation Data Setting

(1) Parameter Setting

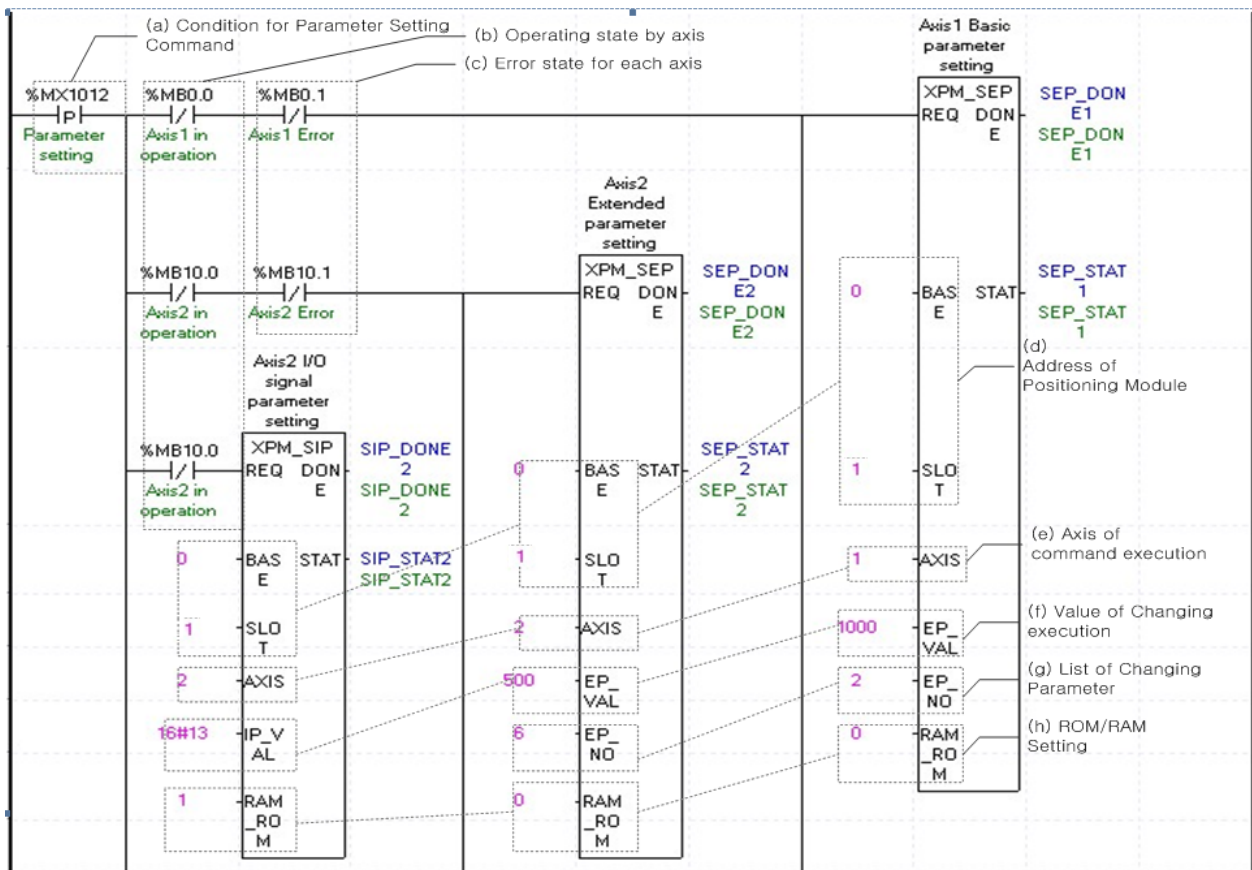

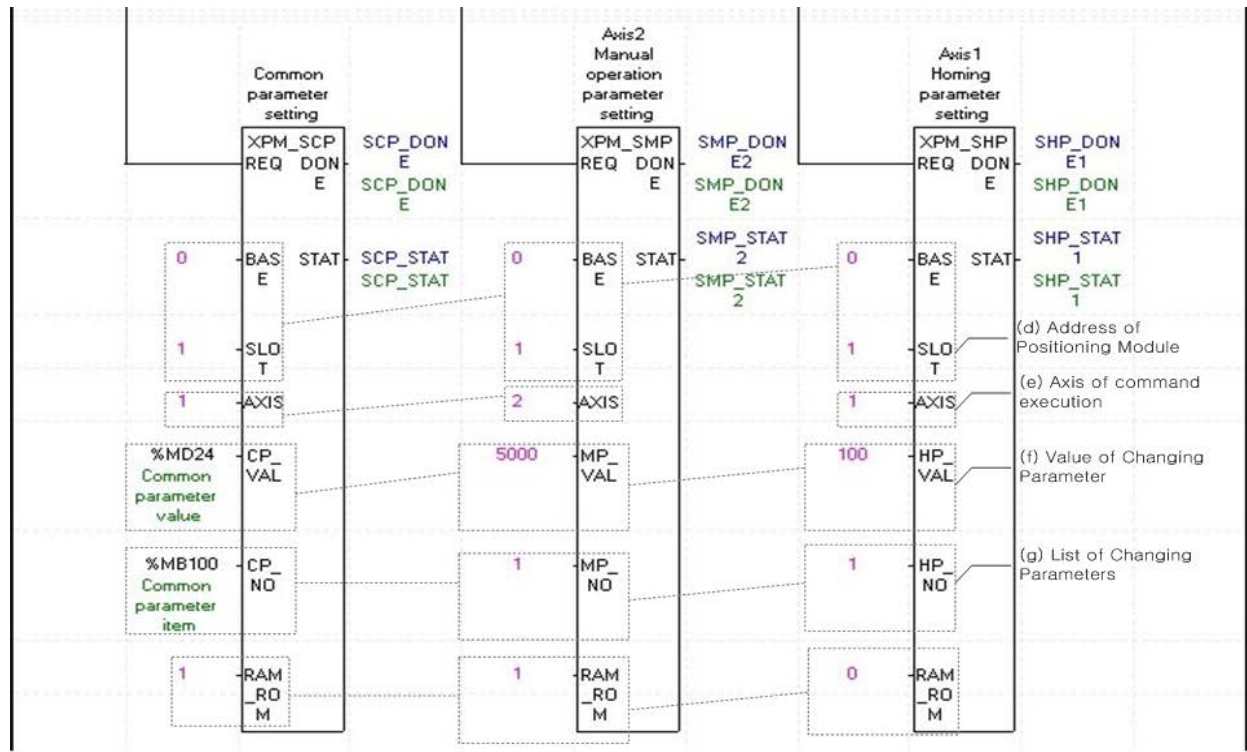

(a) This is the condition for Parameter Setting Command

This is the condition for Parameter Setting Command (XPM_SBP, XPM_SEP, XPM_SHP, XPM_SMP, XPM_SIP, XPM_SCP)

(b) Operating state by axis

According to exercise from "Chapter 7.1.2 Current State Reading," it is a signal of "Operating" for each axis. It turns on when it is operating. Except common parameter setting, parameter setting can not be configured while it is running hence configuration will only be configured when it is not running. If you execute Parameter Setting while it is running, the "error 471" would be appeared.

(c) Error state for each axis

According to exercise from "Chapter 7.1.2 Current State Reading," it is a signal of "Error state" for each axis. It turns on when an error occurred. Operation will only work when there is no error. If you want to operate a system regardless of errors, you can just inactivate the function.

(d) Address of Positioning Module

In this example, Positioning Module is fixed at the 1 slot of 0 bases.

(e) Axis of command execution

You can set an axis for Parameter Setting. UP type supports for 4 axes. In the "execution of axis" from the configuration of Parameter Setting, you can set a value for axis1 through axis4.

(f) Value of Changing Parameter

You can set a value of changing parameter. For more information about Parameter Value Changing look for "Chapter 6. Command." In case of setting I/O parameter, the value would be parameter value itself.

(g) List of Changing Parameter

You need to set a list for parameter (f) changing from set command. Once operating is working, this value will change to parameter (f). For more information of list of changing parameter look for "Chapter 6. Command." In case of setting I/O parameter, the value would be parameter value itself. Therefore changing of list would not be necessary.

(h) ROM/RAM Setting

Chapter 7 Program

This function sets whether you save value of changing parameter to Rom or Ram. If you choose Rom the data will be saved regardless of power and if you save in the ram the data will be vanished when powers off. This parameter sets as 1 means Rom saved, and sets as 0 means Ram saved. There is no limitation of saving parameters in the Rom since parameter of Positioning Module saved in the FRAM.

(i) Execution content of each function block is as follows.

XPM_SBP : RAM Setting Acc. Time of basic parameter of axis1 as 1000ms

XPM_SEP : RAM Setting 2 axes linear interpolation continuous operation position that circular arc is added as 500

XPM_SHP : RAM Setting position of origin of axis1 homing parameter as 100.

XPM_SMP : ROM Setting Jog speed of axis2 manual operation parameter as 5000.

XPM_SIP : ROM Setting axis2 I/O signal parameter value as 16#13(High/Low limit, Emergency/Dec. Stop signals are B contact point)

XPM_SCP : ROM Setting %MB100 of common parameter as %MD24.

(2) Operating Data Setting

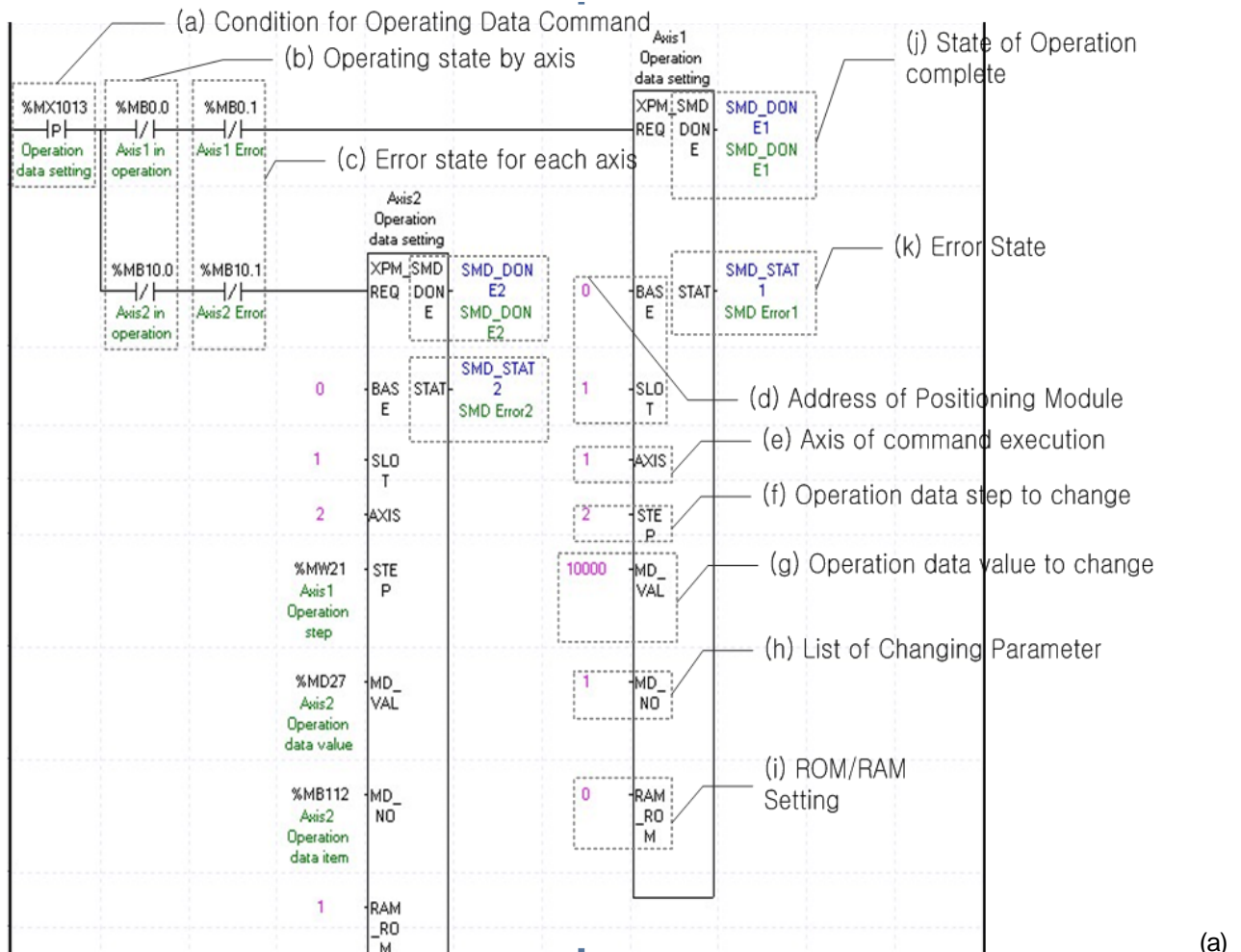

This is the condition for Operating Data Setting Command

This is the condition for Operating Data Setting Command (SMD)

(b) Operating state by axis

According to exercise from “Chapter 7.1.2 Current State Reading,” it is a signal of “Operating” for each axis. It turns on when it is operating. Operating Data Setting can be configured while it is running. If you execute Operating Data Setting while it is running, it is reflected after current step operating ended.

(c) Error state for each axis

According to exercise from “Chapter 7.1.2 Current State Reading,” it is a signal of “Error state” for each axis. It turns on when an error occurred. Operation will only work when there is no error. If you want to operate a system regardless of errors, you can just inactivate the function.

(d) Address of Positioning Module

In this example, Positioning Module is fixed at the 1 slot of 0 bases.

(e) Axis of command execution

You can set an axis for Parameter Setting. UP type supports for 4 axes. In the “execution of axis” from the configuration of Parameter Setting, you can set a value for axis1 through axis4.

(f) Operation data step to change

Set the operation data step no. to change with operation data setting command. UP type can set 400 step operation

Chapter 7 Program

data per each axis and the data would be 0 to 400. If the data is set as "0", it means "Current step" of operation data of corresponding axis.

(g) Operation data value to change

Set the value of operation data to change.

(h) List of Changing Parameter

You need to set a list for parameter (h) changing from set command. Once operating is working, this value will change to parameter (h). Each value of Operating Data is listed below. For example if you put 1000 for value of Changing Operating Data and 4 for Operating data then the value of Dwell is going to be set as 1000ms.

Setting value	Operation Data
1	Goal position
2	Circle interpolation support position
3	Operation speed
4	Dwell time
5	M code No.
6	Second axis setting
7	Helical interpolation axis
8	Count for circle interpolation turn
9	Coordinate
10	Control method
11	Operation method
12	Operation pattern
13	Size of circle
14	Acceleration No.
15	Deceleration No.
16	Circle interpolation method
17	Circle interpolation direction

(i) ROM/RAM Setting

This function sets whether you save value of changing parameter to Rom or Ram. If you choose Rom the data will be saved regardless of power and if you save in the ram the data will be vanished when powers off. This parameter sets as 1 means Rom saved, and sets as 0 means Ram saved. There is no limitation of saving parameters in the Rom since parameter of Positioning Module saved in the FRAM.

(j) State of Operation complete

If function block is completed without error, "1" will be outputted and maintain "1" until the next operation. If error occurred, "0" will be outputted.

(k) Error State

This is the area that output error no. if there are errors in operation of function block.

(l) Execution content of each function block is as follows.

Operation data setting for axis1 : RAM Setting the goal position on step no.2 of axis1 operation data as 10000.

Operation data setting for axis2 : ROM Setting %MB112(Operation data item of axis2) of axis2 operation data %MW41(Operation step of axis2) step as %MD27(Operation data value of axis2).

(3) Operation Data Teaching Array

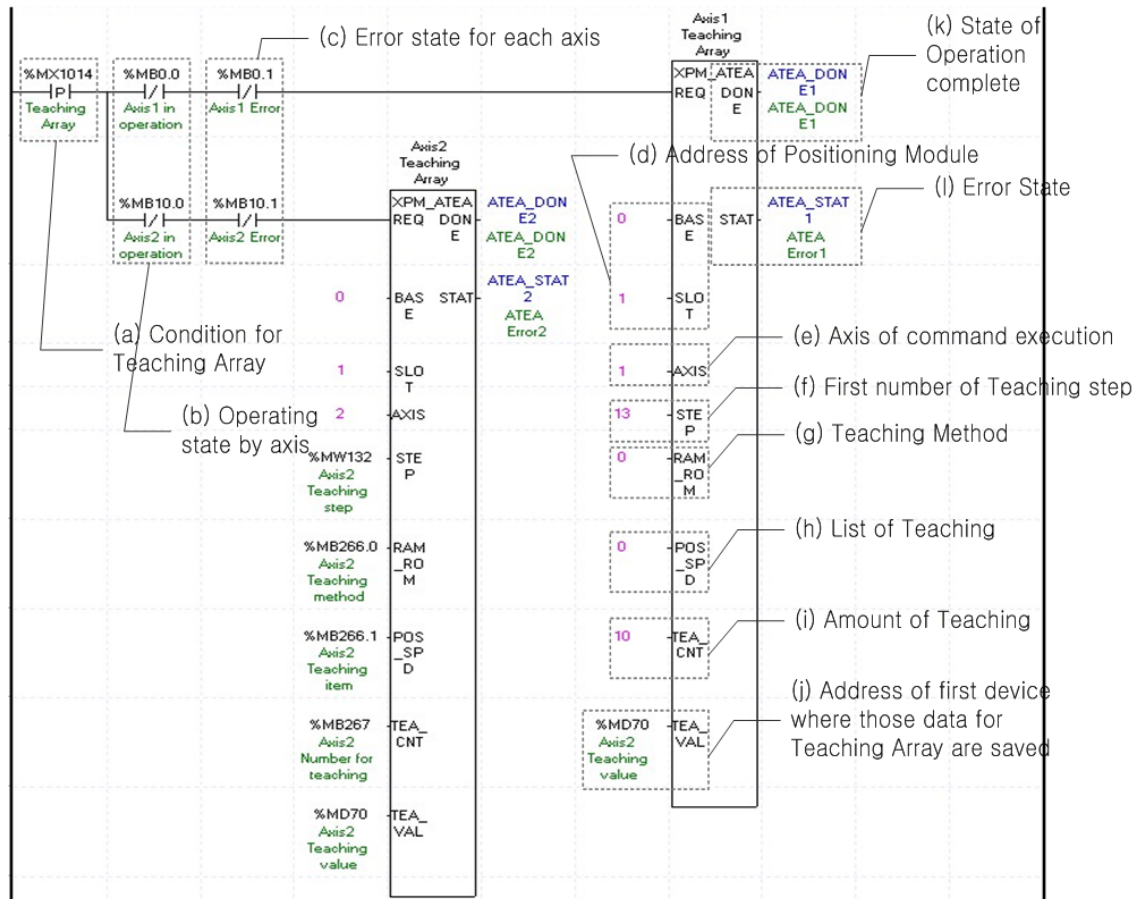

(a) This is the condition for Teaching Array
Condition Teaching Array Command (XPM_ATEA)

(b) Operating state by axis

According to exercise from "Chapter 7.1.2 Current State Reading," it is a signal of "Operating" for each axis. It turns on when it is operating. If you execute Teaching Array while it is running, the step data will be change instantly. But the step data in operation will be change after the end of current step operation.

(c) Error state for each axis

According to exercise from "Chapter 7.1.2 Current State Reading," it is a signal of "Error state" for each axis. It turns on when an error occurred. Operation will only work when there is no error. If you want to operate a system regardless of errors, you can just inactivate the function.

(d) Address of Positioning Module

In this example, Positioning Module is fixed at the 1 slot of 0 bases.

(e) Axis of command execution

You can set an axis for Parameter Setting. UP type supports for 4 axes. In the "execution of axis" from the configuration of Parameter Setting, you can set a value for axis1 through axis4.

(f) First number of Teaching Step

You can setup the first number of Teaching Step among the Operating Data step. In this example above, Teaching Array of axis1 will be operate from 22th step, which is 10th step away from 13th step, hence it will be operate between

Chapter 7 Program

13th step and 22th step.

(g) Teaching Method

This function sets whether you save value of changed Teaching data to Rom or Ram. If you choose Rom the data will be saved regardless of power and if you save in the ram the data will be vanished when powers off. This parameter sets as 1 means Rom saved, and sets as 0 means Ram saved. There is no limitation of saving parameters in the Rom since parameter of Positioning Module saved in the FRAM.

(h) List of Teaching

You can set a data with Teaching Method among the Operating Data. Both "Goal Position" and "Operating Speed" can be changed by Teaching Array. When its value set "0" means set a Goal Position and "1" means set an Operating Speed.

(i) Amount of Teaching

Decide how many steps will be operated using by Teaching Method. Maximum 16 Teaching Array data can be used. For more information about Teaching Array Operation, look for reference from "Chapter 6.4.8"

(j) Address of first device where those data for Teaching Array are saved

To execute a Teaching Array, you need to set a specific value first. TWR commands are using for set up those Teaching Array data. It has to be done before actual Teaching Array operation. Teaching Data will be set up depends on number of first device as below table.

Value	Device No.	Teaching Array Data
1	Device + 0	Teaching Array Data 1
2	Device + 1	Teaching Array Data 2
3	Device + 2	Teaching Array Data 3
4	Device + 3	Teaching Array Data 4
5	Device + 4	Teaching Array Data 5
6	Device + 5	Teaching Array Data 6
7	Device + 6	Teaching Array Data 7
8	Device + 7	Teaching Array Data 8
9	Device + 8	Teaching Array Data 9
10	Device + 9	Teaching Array Data 10
11	Device + 10	Teaching Array Data 11
12	Device + 11	Teaching Array Data 12
13	Device + 12	Teaching Array Data 13
14	Device + 13	Teaching Array Data 14
15	Device + 14	Teaching Array Data 15
16	Device + 15	Teaching Array Data 16

(k) State of Operation complete

If function block is completed without error, "1" will be outputted and maintain "1" until the next operation. If error occurred, "0" will be outputted.

(l) Error State

This is the area that output error no. if there are errors in operation of function block.

(m) Execution content of each function block is as follows.

Axis1 Teaching Array : Execute RAM Teaching the position value of 10 steps from no.13 to no.22 of axis1 as the value saved in %MD50 ~ %MD59.

Axis2 Teaching Array : Teaching the items of 2axis(from %MW132~%MB266.1) as the value saved in that from %MD70 to MB267 by %MB266.0

occurred, "0" will be outputted.

(g) Error State

This is the area that output error no. if there are errors in operation of function block.

7.1.5 Positioning Operation

(1) Homing

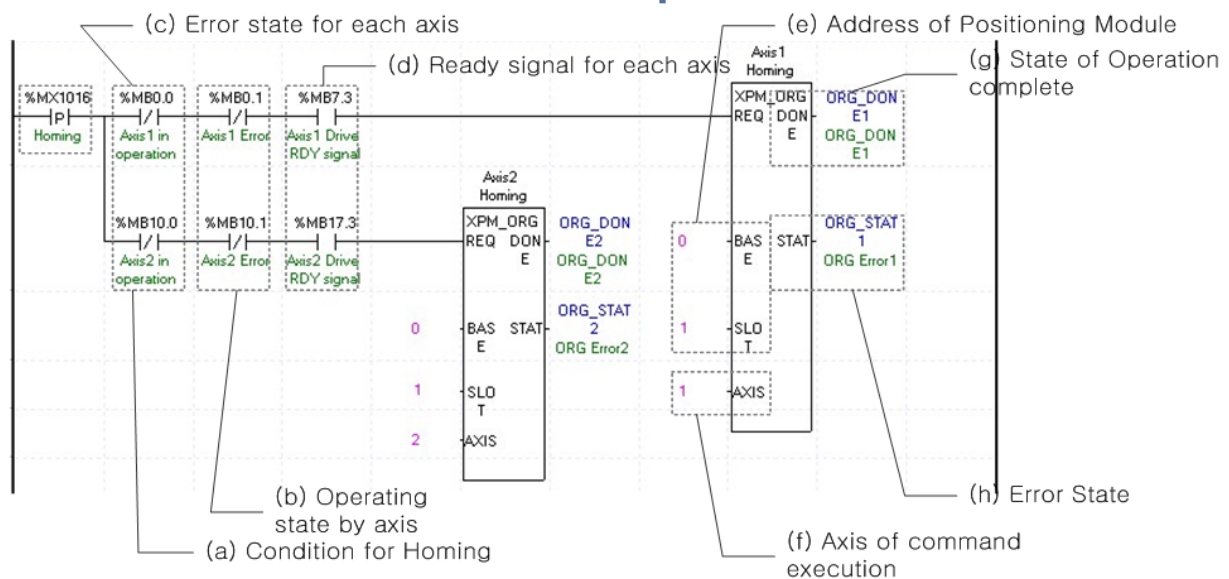

(a) This is the condition for Homing

This is the condition for Homing Command (SPM_ORG)

(b) Operating state by axis

According to exercise from "Chapter 7.1.2 Current State Reading," it is a signal of "Operating" for each axis. It turns on when it is operating. Homing command can not be configured while it is running hence configuration will only be configured when it is not running. If you execute Homing while it is running, the "error 291" would be appeared.

(c) Error state for each axis

According to exercise from "Chapter 7.1.2 Current State Reading," it is a signal of "Error state" for each axis. It turns on when an error occurred. Operation will only work when there is no error. If you want to operate a system regardless of errors, you can just inactivate the function.

(d) Ready signal for each axis

According to exercise from "Chapter 7.1.2 Current State Reading," it is a signal of "Drive Ready" for each axis. This command only works when this is the condition for Drive Ready is on. If it is not set as "ON," the "error 295" would be appeared.

(e) Address of Positioning Module

In this example, Positioning Module is installed at the 1 slot of 0 bases.

(f) Axis of command execution

You can set an axis for Inching Operation. UP type supports for 4 axes. In the "execution of axis" from the configuration of Manual Operation, you can set a value for axis1 through axis4.

(g) State of Operation complete

If function block is completed without error, "1" will be outputted and maintain "1" until the next operation. If error occurred, "0" will be outputted.

(h) Error State

This is the area that output error no. if there are errors in operation of function block.

(i) For more information, reference for Homing is in the "Chapter 8.1."

(2) Direct Start

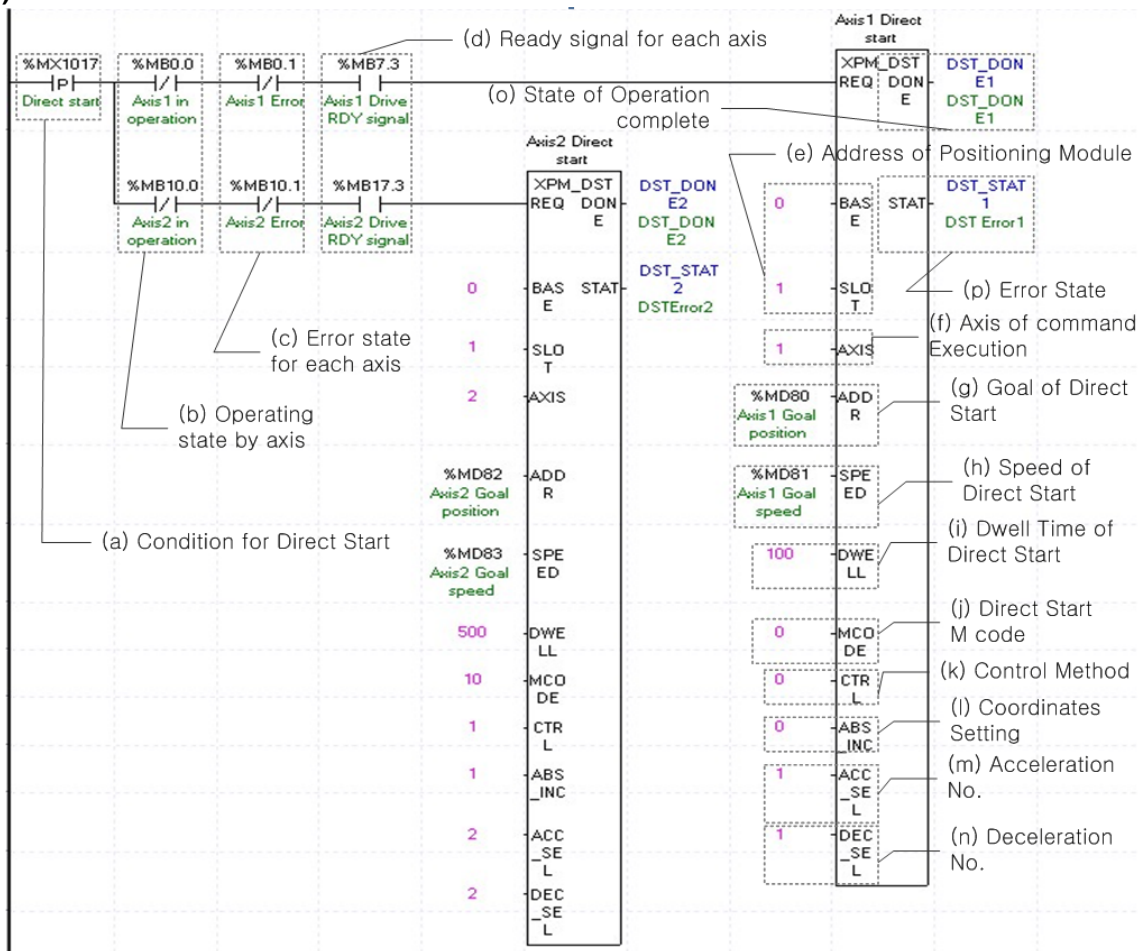

(a) This is the condition for Direct Start

This is the condition for Direct Start Command (XPM_DST)

(b) Operating state by axis

According to exercise from “Chapter 7.1.2 Current State Reading,” it is a signal of “Operating” for each axis. It turns on when it is operating. Direct Start command can not be configured while it is running hence configuration will only be configured when it is not running. If you execute Direct Start while it is running, the “error 221” would be appeared.

(c) Error state for each axis

According to exercise from “Chapter 7.1.2 Current State Reading,” it is a signal of “Error state” for each axis. It turns on when an error occurred. Operation will only work when there is no error. If you want to operate a system regardless of errors, you can just inactivate the function.

(d) Ready signal for each axis

According to exercise from “Chapter 7.1.2 Current State Reading,” it is a signal of “Drive Ready” for each axis. This command only works when this is the condition for Drive Ready is on. If it is not set as “ON,” the “error 225” would be appeared.

(e) Address of Positioning Module

In this example, Positioning Module is fixed at the 1 slot of 0 bases.

(f) Axis of command execution

You can set an axis for Inching Operation. UP type supports for 4 axes. In the “execution of axis” from the configuration of Manual Operation, you can set a value for axis1 through axis4.

(g) Goal of Direct Start

Decide changing position of Direct Start command. In this example above, the initialized value is "device," but you can also change it with "real numbers," which data type is "DINT."

(H) Speed of Direct Start

Decide goal speed of Direct Start. In this example above, the initialized value is "device," but you can also change it with "real numbers," which data type is "UDINT."

(i) Dwell Time of Direct Start

Dwell Time consider as a total amount of time from beginning of Direct Start operation that reach to the goal position and make output of Positioning Done Signal. That means after done its operation, direct Start will make a Positioning done signal. Its unit is "ms," and type is "UINT"

(j) Direct Start M code

You can set a value of M code which are displaying of Operating Parameter by Direct Start. The way of M code outputs are "Parameter Expansion, M code Mode," within the "None, With, After." It will make an M code besides you choose "None" for its parameter. For more information, reference for M code is in the "Chapter 4.2.2"

(k) Control method

Set direct start. Follows are executed depending on setting value.

- 0 : Position control
- 1 : Speed control
- 2 : Feed control

(l) Coordinates setting

Set the operating coordinates of direct start. Followings are executed depending on setting value.

- 0 : Absolute coordinates
- 1 : Relative coordinates

(m) Acceleration No.

Set the acc. No. used in positioning control. It operates by corresponding acc. Time of basic parameter depending on setting value.

- 0 : Acc. Time 1
- 1 : Acc. Time 2
- 2 : Acc. Time 3
- 3 : Acc. Time 4

(n) Deceleration No.

Set the dec. No. used in positioning control. It operates by corresponding dec. Time of basic parameter depending on setting value.

- 0 : Dec. Time 1
- 1 : Dec. Time 2
- 2 : Dec. Time 3
- 3 : Dec. Time 4

(o) State of Operation complete

If function block is completed without error, "1" will be outputted and maintain "1" until the next operation. If error occurred, "0" will be outputted.

(p) Error State

This is the area that output error no. if there are errors in operation of function block.

(q) The function block used in the example is as follows.

Axis1 Direct Start : Execute position control with Axis1 Goal Position %MD80(axis1 Goal position), Goal Speed %MD81(axis Goal Speed), Dwell time 100ms, M code 0, Absolute coordinates, Acc. Time1, Dec Time 1

Chapter 7 Program

Axis2 Direct Start : Execute position control with Axis1 Goal Position %MD82(axis2 Goal position), Goal Speed %MD83(axis2 Goal Speed), Dwell time 500ms, M code 0, Absolute coordinates, Acc. Time 2, Dec Time 2

(3) Indirect Start

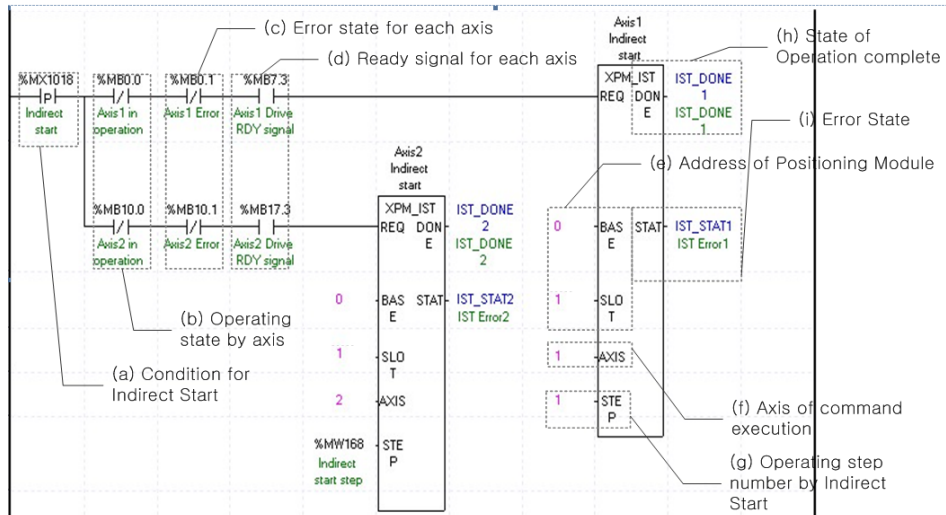

(a) This is the condition for Indirect Start

This is the condition for Indirect Start Command (XPM_IST)

(b) Operating state by axis

According to exercise from "Chapter 7.1.2 Current State Reading," it is a signal of "Operating" for each axis. It turns on when it is operating. Operating Data Setting can not be configured while it is running hence configuration will only be configured when it is not running. If you execute Indirect Start while it is running, the "error 231" would be appeared.

(c) Error state for each axis

According to exercise from "Chapter 7.1.2 Current State Reading," it is a signal of "Error state" for each axis. It turns on when an error occurred. Operation will only work when there is no error. If you want to operate a system regardless of errors, (a) can just inactivate the function.

(d) Ready signal for each axis

According to exercise from "Chapter 7.1.2 Current State Reading," it is a signal of "Drive Ready" for each axis. This command only works when this is the condition for Drive Ready is on. If it is not set as "ON," the "error 235" would be appeared.

(e) Address of Positioning Module

In this example, Positioning Module is fixed at the 1 slot of 0 bases.

(f) Axis of command execution

You can set an axis for Parameter Setting. UP type supports for 4 axes. In the "execution of axis" from the configuration of Parameter Setting, you can set a value for axis1 through axis4.

(g) Operating step number by Indirect Start

Set the operating step number by indirect start for main Axis of command execution.

(h) State of Operation complete

If function block is completed without error, "1" will be outputted and maintain "1" until the next operation. If error occurred, "0" will be outputted.

(i) Error State

This is the area that output error no. if there are errors in operation of function block.

(j) Indirect start operates by appointing step of position data for each axis. Therefore it could run those commands of Positioning control, Speed control, Feed control, Linear circular interpolation depends on setting of positioning data. For

more information, reference for Setting of Operating Data is in the “Chapter4.8.”

(k) The operation of function block is as follows.

Axis1 Indirect Start : Execute step no.1 of axis1 by indirect start

Axis2 Indirect Start : Execute %MW168(Indirect start step) of axis2 by indirect start

(4) Ellipse Interpolation

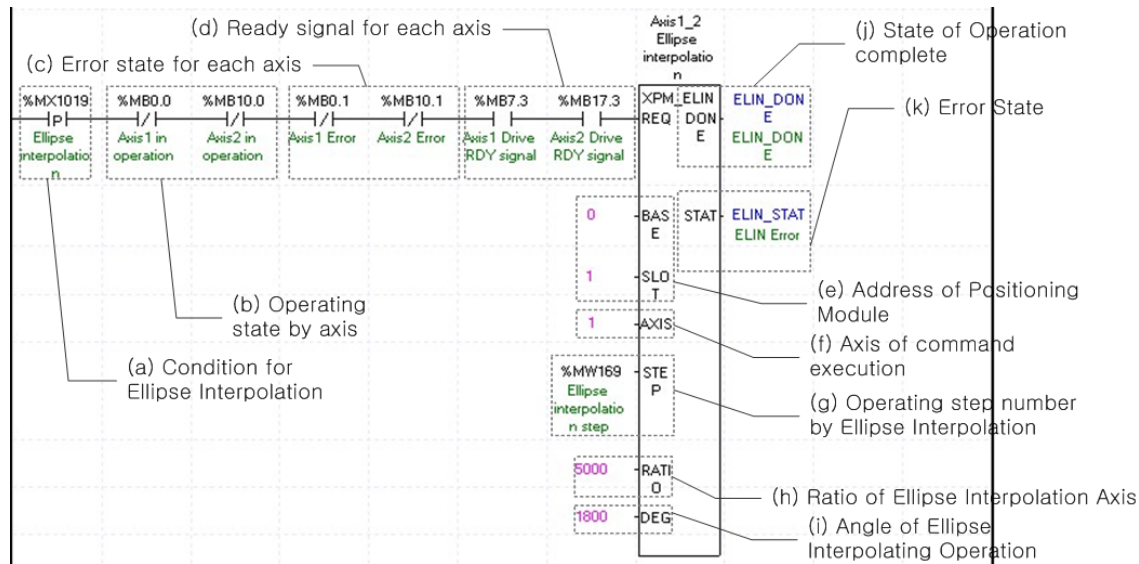

(a) This is the condition for Ellipse Interpolation

This is the condition for Ellipse Interpolation Command (XELIN)

(b) Operating state by axis

According to exercise from “Chapter 7.1.2 Current State Reading,” it is a signal of “Operating” for each axis. It turns on when it is operating. Operating Data Setting can not be configured while it is running hence configuration will only be configured when it is not running. If you execute Ellipse Interpolation while it is running, the “error 541” would be appeared.

(c) Error state for each axis

According to exercise from “Chapter 7.1.2 Current State Reading,” it is a signal of “Error state” for each axis. It turns on when an error occurred. Operation will only work when there is no error. If you want to operate a system regardless of errors, you can just inactivate the function.

(d) Ready signal for each axis

According to exercise from “Chapter 7.1.2 Current State Reading,” it is a signal of “Drive Ready” for each axis. This command only works when this is the condition for Drive Ready is on. If a Drive Ready of main axis is not set as “ON,” the “error 549” would be appeared and If a Drive Ready of subordinate axis is not set as “ON,” the “error 550” would be appeared and

(e) Address of Positioning Module

In this example, Positioning Module is fixed at the 1 slot of 0 bases.

(f) Axis of command execution

You can set an axis for Parameter Setting. UP type supports for 4 axes. In the “execution of axis” from the configuration of Parameter Setting, you can set a value for axis1 through axis4.

(g) Operating step number by Ellipse Interpolation

Set the operating step number by Ellipse Interpolation. The setting of main operating step and subordinate step is the same.

(h) Ratio of Ellipse Interpolation Axis

Chapter 7 Program

Set both ratio values for main and subordinate axis of set operates data from circular interpolation locus. It is to change circular locus into ellipse locus by using ratio of main and subordinate axis.

(i) Angle of Ellipse Interpolating Operation

Set the degree for Ellipse Interpolating Operation. Unit is $[X10^{-1}$ degree]. For more information, reference for Ellipse Interpolation is in the "Chapter 8.2.13"

(j) State of Operation complete

If function block is completed without error, "1" will be outputted and maintain "1" until the next operation. If error occurred, "0" will be outputted.

(k) Error State

This is the area that output error no. if there are errors in operation of function block.

(l) The function block used in the example is as follows.

Axis1_2 Ellipse interpolation: Execute ellipse interpolation of 180° , ratio of between axis as 50% with operation data of %MW169(Ellipse interpolation step)step.

(5) Synchronous Start

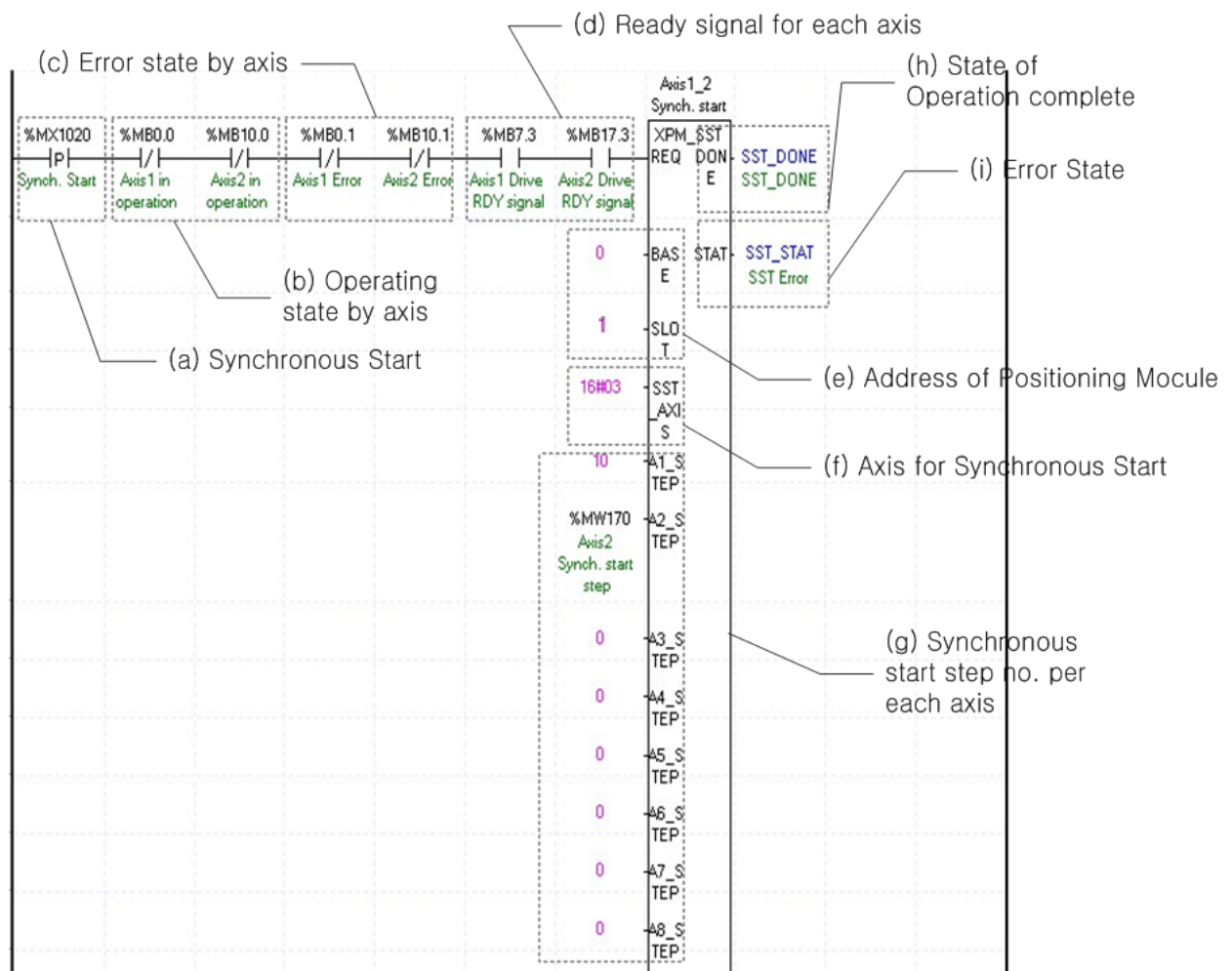

(a) This is the condition for Synchronous Start

This is the condition for Synchronous Start Command

(b) Operating state by axis

According to exercise from "Chapter 7.1.2 Current State Reading," it is a signal of "Operating" for each axis. It turns on

when it is operating. Operating Data Setting can not be configured while it is running hence configuration will only be configured when it is not running. If you execute Axis1 Synchronous Start while it is running, the “error 291” would be appeared.

(c) Error state by axis

According to exercise from “Chapter 7.1.2 Current State Reading,” it is a signal of “Error state” for each axis. It turns on when an error occurred. Operation will only work when there is no error. If you want to operate a system regardless of errors, you can just inactivate the function.

Chapter 7 Program

(d) Ready signal for each axis

According to exercise from "Chapter 7.1.2 Current State Reading," it is a signal of "Drive Ready" for each axis. This command only works when this is the condition for Drive Ready is on. If it is not set as "ON," the "error 295" would be appeared.

(e) Address of Positioning Module

In this example, Positioning Module is fixed at the 1 slot of 0 bases.

(f) Axis for Synchronous Start

Set axis for Synchronous Start. The axis for Synchronous Start uses a "bit" from WORD Data setting as a "1" for each axis. Axis for each bits are as below.

15~4 Bit	3Bit	2Bit	1Bit	0Bit
N/A	Axis 4	Axis 3	Axis 2	Axis1

(g) Synchronous start step no. per each axis

Set the step no. of each axis for synchronous start. UP type can control 4 axes, it doesn't use A4_STEP ~ A8_STEP input.

(h) State of Operation complete

If function block is completed without error, "1" will be outputted and maintain "1" until the next operation. If error occurred, "0" will be outputted.

(i) Error State

This is the area that output error no. if there are errors in operation of function block.

(j) The function block used in the example is as follows.

Axis1_2 Synchronous start : Execute no.10 operation step of axis1 and step of %MW170(axis2 synchronous start step) synchronously.

(6) Point Operation

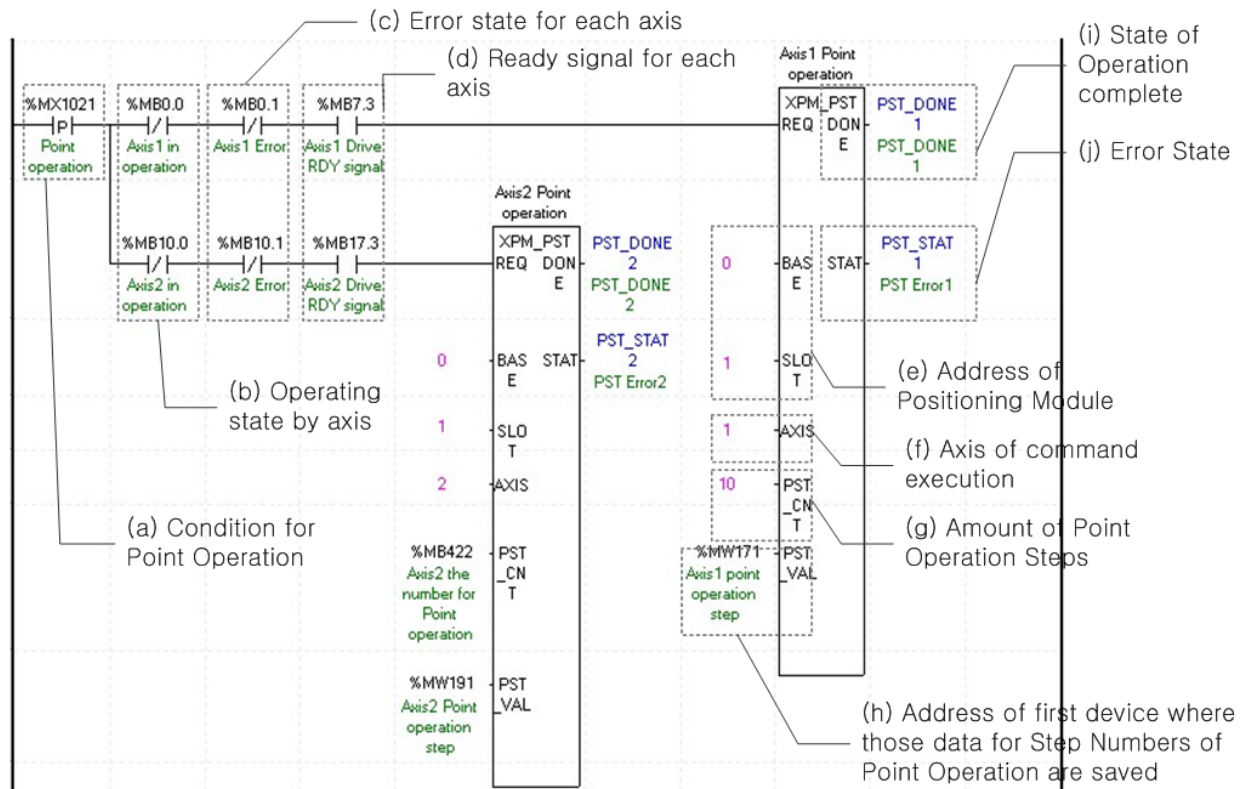

(a) This is the condition for Point Operation

This is the condition for Point Operation Command (XPM_PST).

(b) Operating state by axis

According to exercise from "Chapter 7.1.2 Current State Reading," it is a signal of "Operating" for each axis. It turns on when it is operating. Operating Data Setting can not be configured while it is running hence configuration will only be configured when it is not running. If you execute Point Operation while it is running, the "error 231" would be appeared.

(c) Error state for each axis

According to exercise from "Chapter 7.1.2 Current State Reading," it is a signal of "Error state" for each axis. It turns on when an error occurred. Operation will only work when there is no error. If you want to operate a system regardless of errors, you can just inactivate the function.

(d) Ready signal for each axis

According to exercise from "Chapter 7.1.2 Current State Reading," it is a signal of "Drive Ready" for each axis. This command only works when this is the condition for Drive Ready is on.

(e) Address of Positioning Module

In this example, Positioning Module is fixed at the 1 slot of 0 bases.

(f) Axis of command execution

You can set an axis for Parameter Setting. UP type supports for 4 axes. In the "execution of axis" from the configuration of Parameter Setting, you can set a value for axis1 through axis4.

(g) Amount of Point Operation Steps

Decide how many steps will be operated. In this example above, 10 Point Operation steps are set in the axis1. Therefore, the step no. saved in %MW171 ~ %MW180 will be executed by point operation. For the details about point operation, refer to "(4) Point operation" of "9.2.17 Positioning start".

Chapter 7 Program

(h) Address of first device where those data for Step Numbers of Point Operation are saved

To execute a Point Operation, you need to set a specific value first. Point Operation Step Data will be set up depends on number of first device as below table.

Value	Device No.	Point Operating Step Data
1	Device + 0	Point Operating Step Data 1
2	Device + 1	Point Operating Step Data 2
3	Device + 2	Point Operating Step Data 3
4	Device + 3	Point Operating Step Data 4
5	Device + 4	Point Operating Step Data 5
6	Device + 5	Point Operating Step Data 6
7	Device + 6	Point Operating Step Data 7
8	Device + 7	Point Operating Step Data 8
9	Device + 8	Point Operating Step Data 9
10	Device + 9	Point Operating Step Data 10
11	Device + 10	Point Operating Step Data 11
12	Device + 11	Point Operating Step Data 12
13	Device + 12	Point Operating Step Data 13
14	Device + 13	Point Operating Step Data 14
15	Device + 14	Point Operating Step Data 15
16	Device + 15	Point Operating Step Data 16
17	Device + 16	Point Operating Step Data 17
18	Device + 17	Point Operating Step Data 18
19	Device + 18	Point Operating Step Data 19
20	Device + 19	Point Operating Step Data 20

(i) State of Operation complete

If function block is completed without error, "1" will be outputted and maintain "1" until the next operation. If error occurred, "0" will be outputted.

(j) Error State

This is the area that output error no. if there are errors in operation of function block.

(7) Speed Synchronization

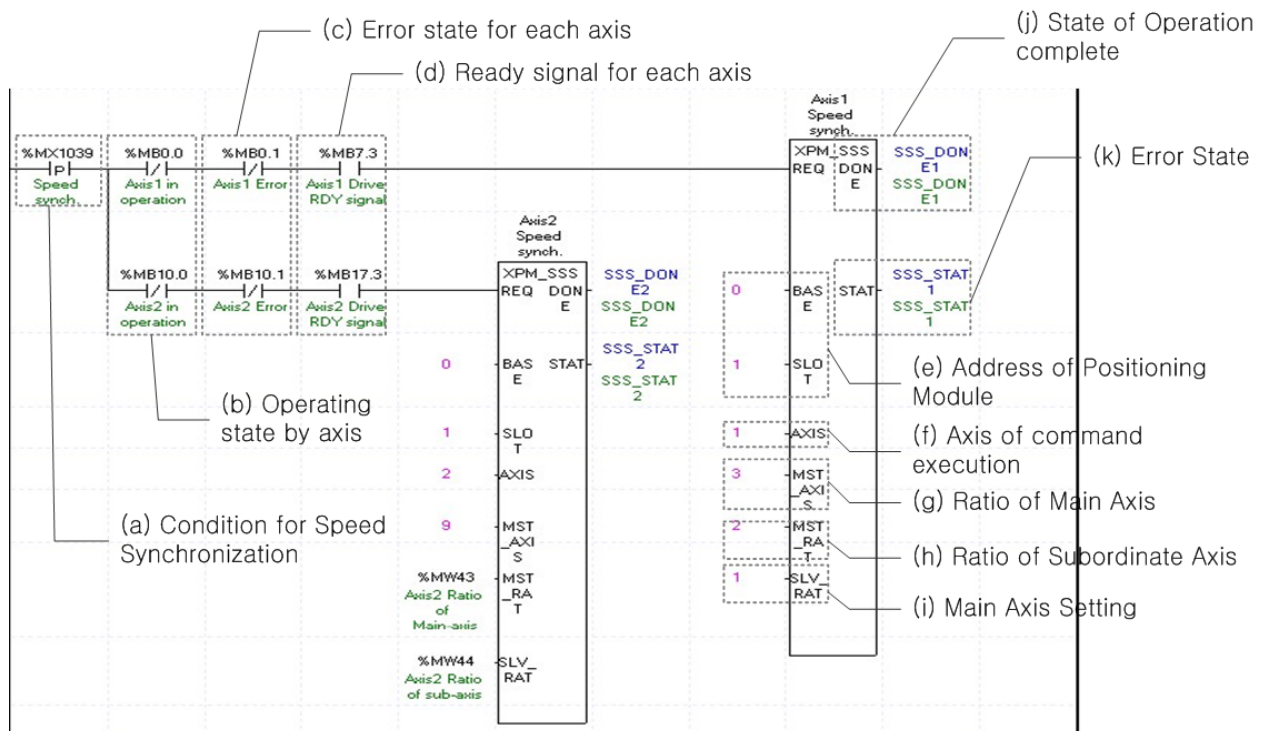

(a) This is the condition for Speed Synchronization

This is the condition for Speed Synchronization Command (XPM_SSS)

(b) Operating state by axis

According to exercise from "Chapter 7.1.2 Current State Reading," it is a signal of "Operating" for each axis. It turns on when it is operating. Operating Data Setting can not be configured while it is running hence configuration will only be configured when it is not running. If you execute Speed Synchronization while it is running, the "error 351" would be appeared.

(c) Error state for each axis

According to exercise from "Chapter 7.1.2 Current State Reading," it is a signal of "Error state" for each axis. It turns on when an error occurred. Operation will only work when there is no error. If you want to operate a system regardless of errors, you can just inactivate the function.

(d) Ready signal for each axis

According to exercise from "Chapter 7.1.2 Current State Reading," it is a signal of "Drive Ready" for each axis. This command only works when this is the condition for Drive Ready is on. If a Drive Ready of main axis is not set as "ON," the "error 354" would be appeared.

(e) Address of Positioning Module

In this example, Positioning Module is fixed at the 1 slot of 0 bases.

(f) Axis of command execution

You can set an axis for Parameter Setting. UP type supports for 4 axes. In the "execution of axis" from the configuration of Parameter Setting, you can set a value for axis1 through axis4.

Chapter 7 Program

(g) Main Axis Setting

Set a main axis to operate Speed Synchronization. This setting is for main axis of Speed Synchronization. This setting cannot be set as same value as Axis of command execution, and possible setting values are as below.

(h) Ratio of Main Axis

Set value for Ratio of Main Axis to execute a Speed Synchronization.

(i) Ratio of Subordinate Axis

Set value for Ratio of Subordinate Axis to execute a Speed Synchronization. In this example above, the ratio of main and subordinate axis is 2:1. Meaning that operational speed ratio of those axis is 2 to 1. So, if main axis is operating in speed of 10000, subordinate axis will be operating in speed of 5000.

Set value	Main Axis
1	Axis 1
2	Axis 2
3	Axis 3
4	Axis 4
5	-
6	-
7	-
8	-
9	Encoder

(j) State of Operation complete

If function block is completed without error, "1" will be outputted and maintain "1" until the next operation. If error occurred, "0" will be outputted.

(k) Error State

This is the area that output error no. if there are errors in operation of function block.

(l) For more information, reference for Speed Synchronization is in the "Chapter 9.4.1."

(8) Position Assign Speed Synchronization

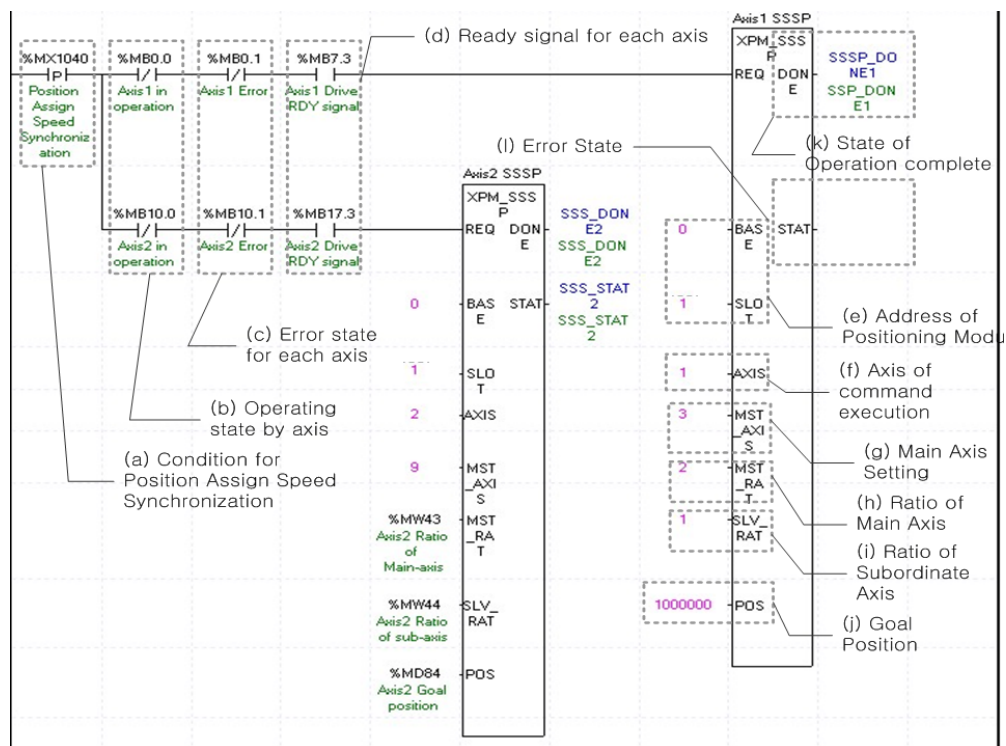

(a) This is the condition for Position Assign Speed Synchronization

This is the condition for Position Assign Speed Synchronization Command (XPM_SSSP)

(b) Operating state by axis

According to exercise from "Chapter 7.1.2 Current State Reading," it is a signal of "Operating" for each axis. It turns on when it is operating. Operating Data Setting can not be configured while it is running hence configuration will only be configured if it is not running. If you execute Position Assign Speed Synchronization while it is running, the "error 351" would be appeared.

(c) Error state for each axis

According to exercise from "Chapter 7.1.2 Current State Reading," it is a signal of "Error state" for each axis. It turns on when an error occurred. Operation will only work when there is no error. If you want to operate a system regardless of errors, you can just inactivate the function.

(d) Ready signal for each axis

According to exercise from "Chapter 7.1.2 Current State Reading," it is a signal of "Drive Ready" for each axis. This command only works when this is the condition for Drive Ready is on. If a Drive Ready of main axis is not set as "ON," the "error 354" would be appeared.

(e) Address of Positioning Module

In this example, Positioning Module is fixed at the 1 slot of 0 bases.

Chapter 7 Program

(f) Axis of command execution

You can set an axis for Parameter Setting. UP type supports for 4 axes. In the “execution of axis” from the configuration of Parameter Setting, you can set a value for axis1 through axis4.

(g) Main Axis Setting

Set a main axis to operate Speed Synchronization. This setting is for main axis of Speed Synchronization. This setting cannot be set as same value as Axis of command execution, and possible setting values are as below.

(h) Ratio of Main Axis

Set value for Ratio of Main Axis to execute a Speed Synchronization.

(i) Ratio of Subordinate Axis

Set value for Ratio of Subordinate Axis to execute a Speed Synchronization. In this example above, the ratio of main and subordinate axis is 2:1. Meaning that operational speed ratio of those axes are 2 to 1. So, if main axis is operating in speed of 10000, subordinate axis will be operating in speed of 5000.

Set value	Main Axis
1	Axis 1
2	Axis 2
3	Axis 3
4	Axis 4
5	-
6	-
7	-
8	-
9	Encoder

(j) Goal Position

Set goal of Position Assign Speed Synchronization. Once Axis of command execution reaches the goal position, Speed Synchronization ends and operation will be stop immediately.

(k) State of Operation complete

If function block is completed without error, “1” will be outputted and maintain “1” until the next operation. If error occurred, “0” will be outputted.

(l) Error State

This is the area that output error no. if there are errors in operation of function block.

(m) For more information, reference for Position Assign Speed Synchronization is in the “Chapter 9.4.1.”

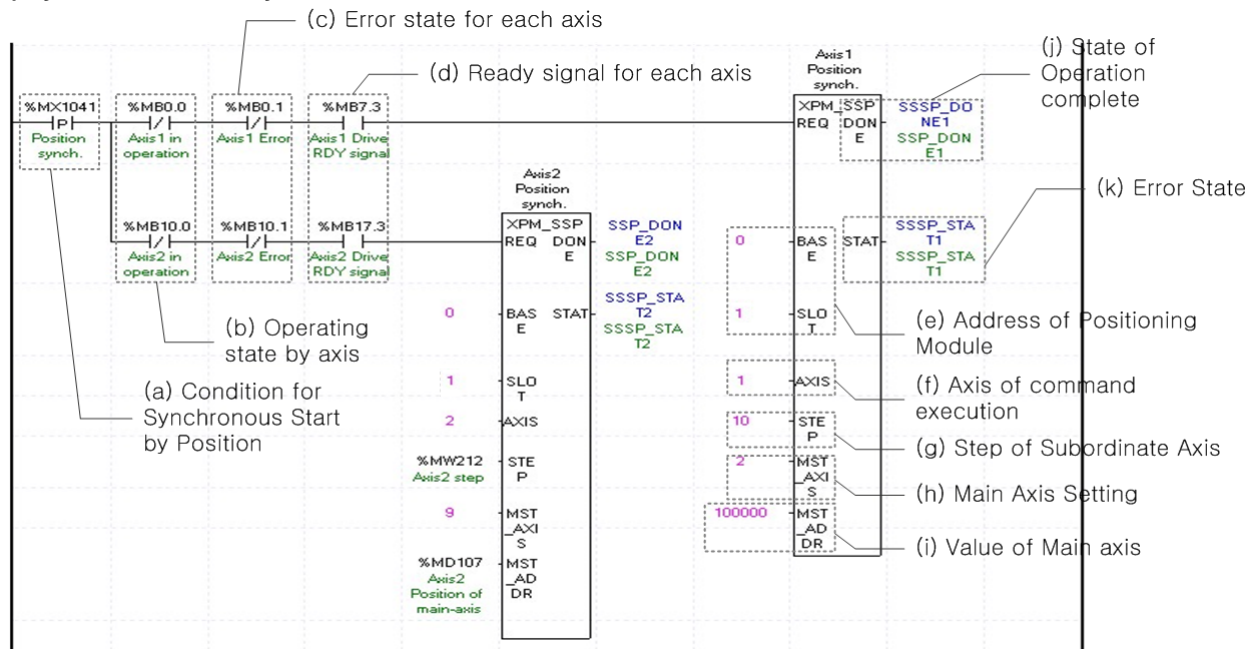
(9) Synchronous Start by Position

(a) This is the condition for Synchronous Start by Position

This is the condition for Synchronous Start by Position Command (XPM_SSP)

(b) Operating state by axis

According to exercise from "Chapter 7.1.2 Current State Reading," it is a signal of "Operating" for each axis. It turns on when it is operating. Operating Data Setting can not be configured while it is running hence configuration will only be configured when it is not running. If you execute Synchronous Start by Position while it is running, the "error 341" would be appeared.

(c) Error state for each axis

According to exercise from "Chapter 7.1.2 Current State Reading," it is a signal of "Error state" for each axis. It turns on when an error occurred. Operation will only work when there is no error. If you want to operate a system regardless of errors, you can just inactivate the function.

(d) Ready signal for each axis

According to exercise from "Chapter 7.1.2 Current State Reading," it is a signal of "Drive Ready" for each axis. This command only works when this is the condition for Drive Ready is on. If a Drive Ready of main axis is not set as "ON," the "error 354" would be appeared.

(e) Address of Positioning Module

In this example, Positioning Module is fixed at the 1 slot of 0 bases.

(f) Axis of command execution

You can set an axis for Parameter Setting. UP type supports for 4 axes. In the “execution of axis” from the configuration of Parameter Setting, you can set a value for axis1 through axis4.

(g) Step of Subordinate Axis

Set step number for Subordinate Axis to execute a Speed Synchronization.

(h) Main Axis Setting

Set a main axis to operate Speed Synchronization. This setting is for main axis of Speed Synchronization.

This setting cannot be set as same value as Axis of command execution, and possible setting values are as below.

(i) Value of Main Axis

Set value for Main Axis to execute Synchronous Start by Position. Therefore main axis will be executed the command when the subordinate axis reaches this set value.

Set value	Main Axis
1	Axis 1
2	Axis 2
3	Axis 3
4	Axis 4
5	-
6	-
7	-
8	-
9	Encoder

(j) State of Operation complete

If function block is completed without error, “1” will be outputted and maintain “1” until the next operation. If error occurred, “0” will be outputted.

(k) Error State

This is the area that output error no. if there are errors in operation of function block.

(l) For more information, reference for Synchronous Start by Position is in the “Chapter 9.4.2.”

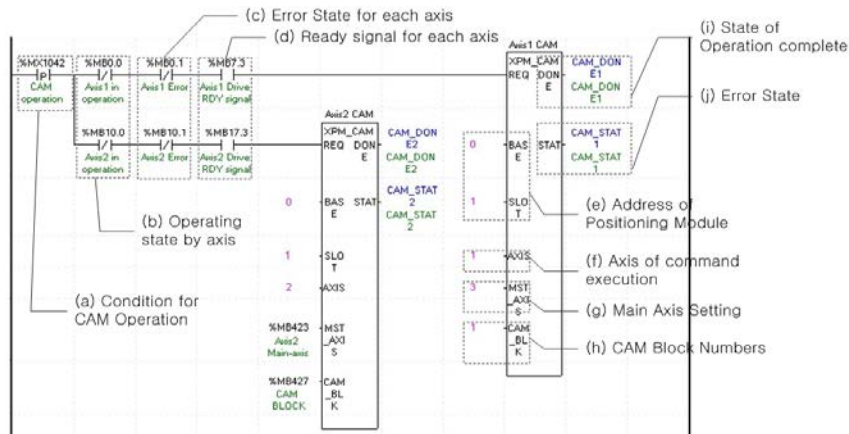
(10) CAM Operation

(a) This is the condition for CAM Operation

This is the condition for CAM Operation Command (XPM_CAM)

(b) Operating state by axis

According to exercise from "Chapter 7.1.2 Current State Reading," it is a signal of "Operating" for each axis. It turns on when it is operating. Operating Data Setting can not be configured while it is running hence configuration will only be configured when it is not running. If you execute CAM Operation while it is running, the "error 701" would be appeared.

(c) Error state for each axis

According to exercise from "Chapter 7.1.2 Current State Reading," it is a signal of "Error state" for each axis. It turns on when an error occurred. Operation will only work when there is no error. If you want to operate a system regardless of errors, you can just inactivate the function.

(d) Ready signal for each axis

According to exercise from "Chapter 7.1.2 Current State Reading," it is a signal of "Drive Ready" for each axis. This command only works when this is the condition for Drive Ready is on. If a Drive Ready of main axis is not set as "ON," the "error 703" would be appeared.

(e) Address of Positioning Module

In this example, Positioning Module is fixed at the 1 slot of 0 bases.

(f) Axis of command execution

You can set an axis for Parameter Setting. UP type supports for 4 axes. In the "execution of axis" from the configuration of Parameter Setting, you can set a value for axis1 through axis4.

(g) Main Axis Setting

Setting of main axis to operate. This setting is for main axis of CAM Operating. This setting cannot be set as same value as Axis of command execution. Can set a value 1~4, meaning from axis1 to axis 4.

(h) CAM Block Numbers

Setting for Block Numbers of CAM data to operate CAM operation. UP type support 8 CAM Blocks. The CAM Data for each Block would be downloaded to module written from Software Package.

(i) Main Axis offset

In case main offset assigned CAM operation command(XPM_CAM0) Second axis set the main axis offset Starting position. When starting command, move to position set in main axis offset and then second axis start CAM operation.

(j) State of Operation complete

If function block is completed without error, "1" will be outputted and maintain "1" until the next operation. If error

occurred, "0" will be outputted.

(k) Error State

This is the area that output error no. if there are errors in operation of function block.

(l) For more information, reference of CAM Operation is in the "Chapter 8.4.3."

(11) Deceleration Stop

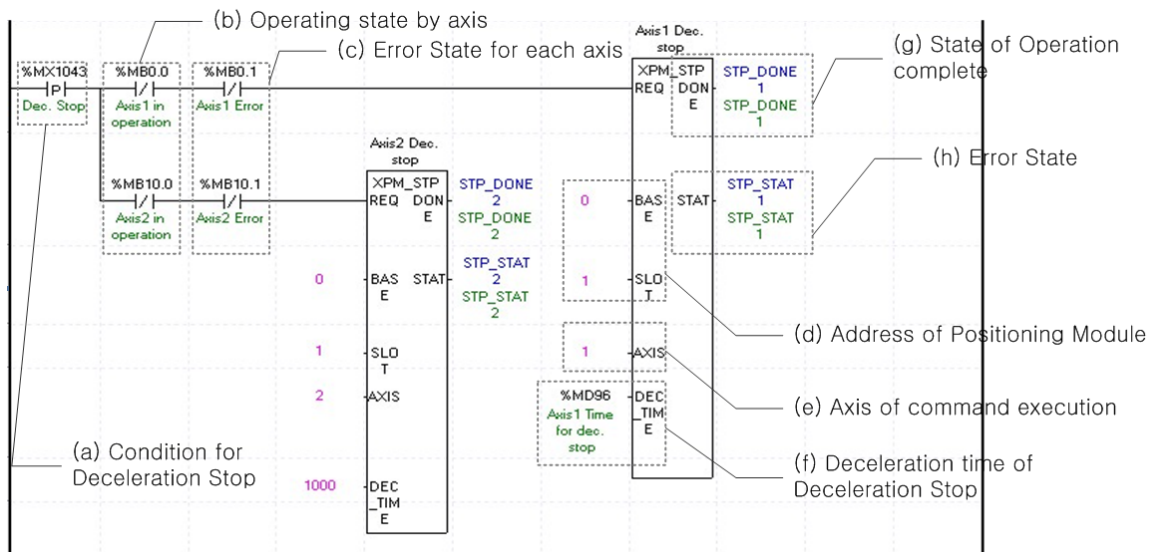

(a) This is the condition for Deceleration Stop

This is the condition for Deceleration Stop Command (XPM_STP)

(b) Operating state by axis

According to exercise from "Chapter 7.1.2 Current State Reading," it is a signal of "Operating" for each axis. It turns on when it is operating. Operating Data Setting can not be configured while it is running hence configuration will only be configured when it is not running.

(c) Error state for each axis

According to exercise from "Chapter 7.1.2 Current State Reading," it is a signal of "Error state" for each axis. It turns on when an error occurred. Operation will only work when there is no error. If you want to operate a system regardless of errors, you can just inactivate the function.

(d) Address of Positioning Module

In this example, Positioning Module is fixed at the 1 slot of 0 bases.

(e) Axis of command execution

You can set an axis for Parameter Setting. UP type supports for 4 axes. In the "execution of axis" from the configuration of Parameter Setting, you can set a value for axis1 through axis4.

(f) Deceleration time of Deceleration Stop

Set a deceleration time of Deceleration Stop operation. Unit of Deceleration Stop is [ms]. Since this time refers deceleration time from the speed limit, there might be little difference between Deceleration Stop set time and actual stop time. The range of deceleration time is "0~2,147,483,674." 1~2,147,483,674 means Deceleration Time set as 1ms ~ 2,147,483,674ms. If it set as "0," it will be operated with set deceleration value. Also it use to stop Speed Synchronous Operation or CAM Operation while Speed and CAM Operation. During this time Deceleration Time is meaningless, CAM Operation is just cancelled.

(g) State of Operation complete

If function block is completed without error, "1" will be outputted and maintain "1" until the next operation. If error occurred, "0" will be outputted.

(h) Error State

This is the area that output error no. if there are errors in operation of function block.

(i) For more information, reference of Deceleration Stop is in the "Chapter 8.2.18."

(j) Operation of each function block is as follows.

Axis1 Dec. Time : When axis1 is in operation, decelerate to %MD96(axis1 Dec. stop Time), then stop.

Axis2 Dec. Time : When axis 2 is in operation, decelerate to 1000ms, then stop.

(13) M code Cancellation

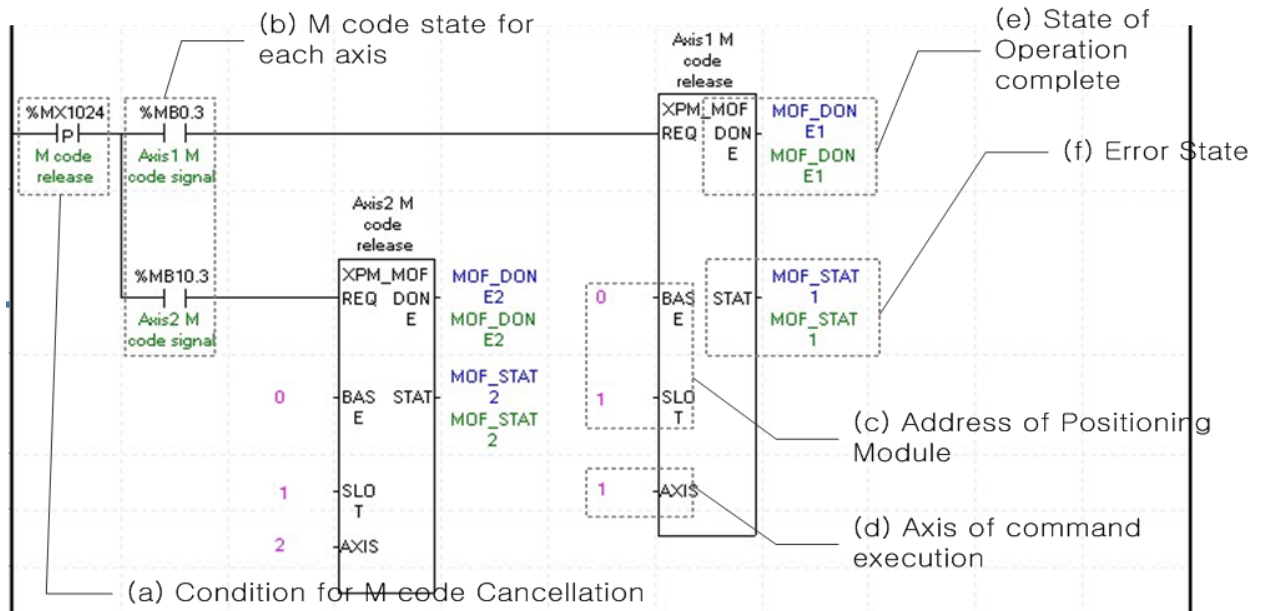

(a) This is the condition for M code Cancellation

This is the condition for M code Cancellation (XPM_MOF). Once M code Cancellation command executed, number of M code would be change to "0," and signal of M code to "Off."

(b) M code state for each axis

According to exercise from "Chapter 7.1.2 Current State Reading," it is a signal of "M Code" for each axis. It turns on when it is operating. M code Cancellation command can only be valid once M code are generated. The condition for execution is operation possible when it is "On."

(c) Address of Positioning Module

In this example, Positioning Module is fixed at the 1 slot of 0 bases.

(d) Axis of command execution

You can set an axis for Parameter Setting. UP type supports for 4 axes. In the "execution of axis" from the configuration of Parameter Setting, you can set a value for axis1 through axis4.

(e) State of Operation complete

If function block is completed without error, "1" will be outputted and maintain "1" until the next operation. If error occurred, "0" will be outputted.

(f) Error State

This is the area that output error no. if there are errors in operation of function block.

(g) For more information, reference of M code Cancellation is in the "Chapter 8.6.2."

7.1.6 Operation Setting Change while Operating

(1) Speed Override

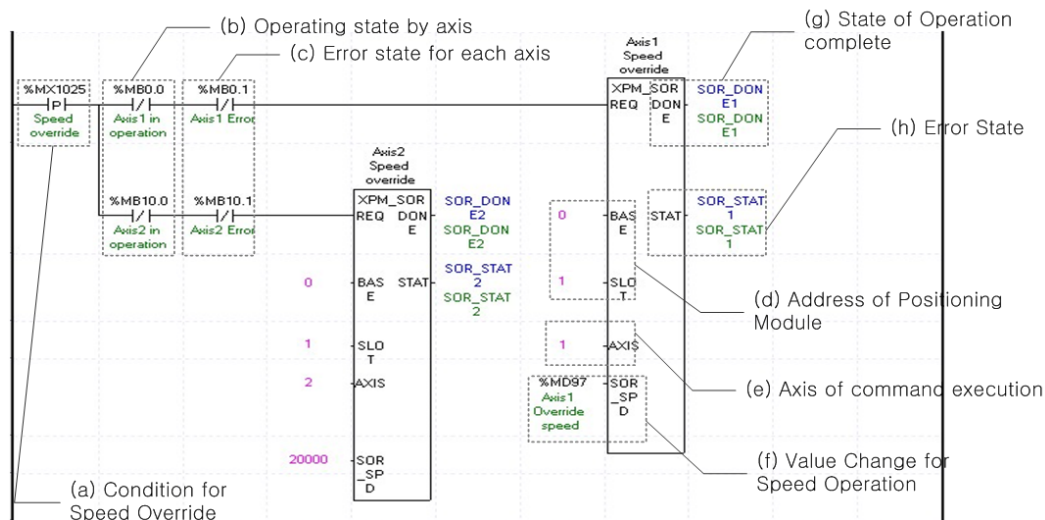

(a) This is the condition for Speed Override

This is the condition for Speed Override Command (XPM_SOR)

(b) Operating state by axis

According to exercise from "Chapter 7.1.2 Current State Reading," it is a signal of "Operating" for each axis. It turns on when it is operating. Operating Data Setting can not be configured while it is running hence configuration will only be configured when it is not running. If you execute Speed Override while it is running, the "error 371" would be appeared.

(c) Error state for each axis

According to exercise from "Chapter 7.1.2 Current State Reading," it is a signal of "Error state" for each axis. It turns on when an error occurred. Operation will only work when there is no error. If you want to operate a system regardless of errors, you can just inactivate the function.

(d) Address of Positioning Module

In this example, Positioning Module is fixed at the 1 slot of 0 bases.

(e) Axis of command execution

You can set an axis for Parameter Setting. UP type supports for 4 axes. In the "execution of axis" from the configuration of Parameter Setting, you can set a value for axis1 through axis4.

(f) Value Change for Speed Operation

Set speed value. According to Speed Override from common parameters, it is a signal of "%" or "Speed Value" depends on setting of category. Also, when Speed Override set as Speed Value, it means Unit/Time depends on Speed Command Unit from basic parameters, or it means "rpm." If a changing Operation Speed Value is "%," then the unit would be $[X10^{-2}\%]$. If it is "rpm," then the unit would be $X10^{-1}\text{rpm}$.

(g) State of Operation complete

If function block is completed without error, "1" will be outputted and maintain "1" until the next operation. If error occurred, "0" will be outputted.

(h) Error State

This is the area that output error no. if there are errors in operation of function block.

(i) The function block in the example above is as follows.

Axis1 Speed Override : The operating speed of axis1 will be changed to speed value saved in %MD97 and then continue to operate.

Axis2 Speed Override : The operating speed of axis2 will be changed to 20000 and then continue to operate.

(j) For more information, reference of Speed Override is in the “Chapter 8.5.5.”

(2) Position Override

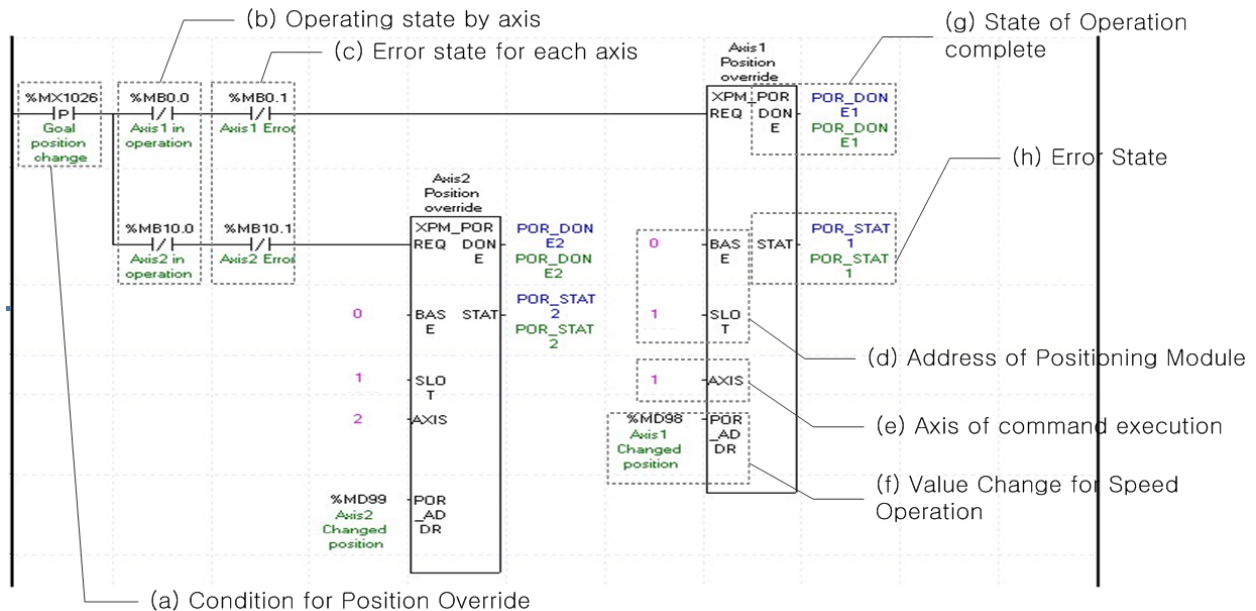

(a) This is the condition for Position Override

This is the condition for Position Override Command (XPM_POR)

(b) Operating state by axis

According to exercise from “Chapter 7.1.2 Current State Reading,” it is a signal of “Operating” for each axis. It turns on when it is operating. Operating Data Setting can not be configured while it is running hence configuration will only be configured when it is not running. If you execute Position Override while it is running, the “error 361” would be appeared.

(c) Error state for each axis

According to exercise from “Chapter 7.1.2 Current State Reading,” it is a signal of “Error state” for each axis. It turns on when an error occurred. Operation will only work when there is no error. If you want to operate a system regardless of errors, you can just inactivate the function.

(d) Address of Positioning Module

In this example, Positioning Module is fixed at the 1 slot of 0 bases.

(e) Axis of command execution

You can set an axis for Parameter Setting. UP type supports for 4 axes. In the “execution of axis” from the configuration of Parameter Setting, you can set a value for axis1 through axis4.

(f) Change for Goal Position Value

Setting Value Change for Goal Position Value. The unit of this value depends on “Unit” category. Once Position Override commands are executed, the goal position of executed axis will be changed to set goal position.

(g) State of Operation complete

If function block is completed without error, “1” will be outputted and maintain “1” until the next operation. If error occurred, “0” will be outputted.

(h) Error State

This is the area that output error no. if there are errors in operation of function block.

(i) The function block in the example above is as follows.

Axis1 Position Override : Goal position of axis1 is changed to the value saved in %MD98.

Axis2 Position Override : Goal position of axis2 is changed to the value saved in %MD99.

(j) For more information, reference of Position Override is in the “Chapter 8.5.4.”

(3) Position Assign Speed Override

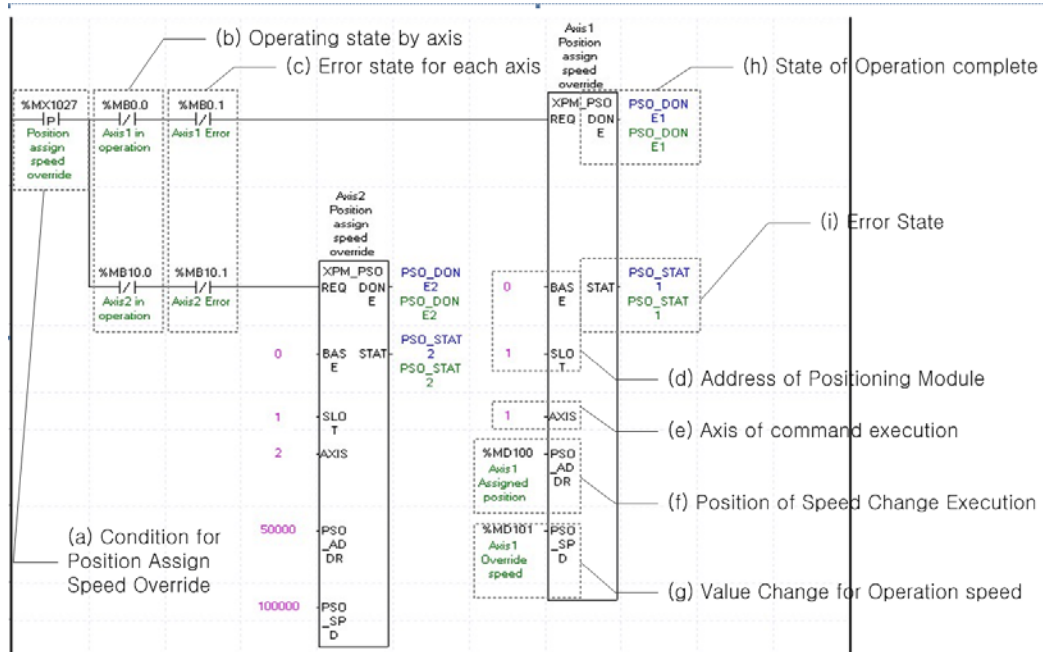

- (a) This is the condition for Position Assign Speed Override
This is the condition for Position Assign Speed Override Command (XPM_PSO)
- (b) Operating state by axis
According to exercise from “Chapter 7.1.2 Current State Reading,” it is a signal of “Operating” for each axis. It turns on when it is operating. Operating Data Setting can not be configured while it is running hence configuration will only be configured when it is not running. If you execute Position Assign Speed Override while it is running, the “error 381” would be appeared.
- (c) Error state for each axis
According to exercise from “Chapter 7.1.2 Current State Reading,” it is a signal of “Error state” for each axis. It turns on when an error occurred. Operation will only work when there is no error. If you want to operate a system regardless of errors, you can just inactivate the function.
- (d) Address of Positioning Module
In this example, Positioning Module is fixed at the 1 slot of 0 bases.
- (e) Axis of command execution
You can set an axis for Parameter Setting. UP type supports for 4 axes. In the “execution of axis” from the configuration of Parameter Setting, you can set a value for axis1 through axis4.
- (f) Position of Speed Change Execution
Set the position of Speed Change. Once the actual position located at set position with speed override command running, the speed change commands are executed.
- (g) Value Change for Operation speed
Set the Value Change for Operation speed. According to Speed Override from common parameters, it is a signal of “%” or “Speed Value” depends on setting of category. Also, when Speed Override set as Speed Value, it means Unit/Time depends on Speed Command Unit from basic parameters, or it means “rpm.” If a changing Operation Speed Value is “%,” then the unit would be [X10⁻²%]. If it is “rpm,” then the unit would be X10⁻¹rpm].
- (h) State of Operation complete

If function block is completed without error, “1” will be outputted and maintain “1” until the next operation. If error occurred, “0” will be outputted.

(i) Error State

This is the area that output error no. if there are errors in operation of function block.

(j) The function block in the example above is as follows.

Axis1 Positioning Speed Override : When the current position of axis1 become the same position as the position saved in %MD100, the speed value will be changed to the speed saved in %MD92.

Axis2 Positioning Speed Override : When the current position of axis1 become 50000, the speed will be changed to 100000.

(k) For more information, reference of Position Assign Speed Override is in the “Chapter 8.5.6.”

(4) Speed/Position Switching Control

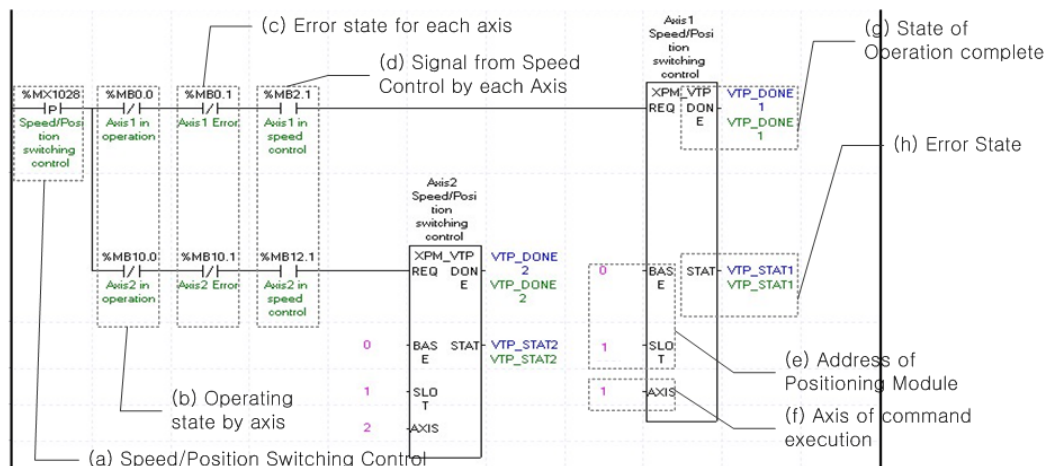

(a) This is the condition for Speed/Position Switching Control

This is the condition for Speed/Position Switching Control Command (XPM_VTP)

(b) Operating state by axis

According to exercise from “Chapter 7.1.2 Current State Reading,” it is a signal of “Operating” for each axis. It turns on when it is operating. Operating Data Setting can not be configured while it is running hence configuration will only be configured when it is not running. If you execute Speed/Position Switching Control while it is running, the “error 301” would be appeared.

(c) Error state for each axis

According to exercise from “Chapter 7.1.2 Current State Reading,” it is a signal of “Error state” for each axis. It turns on when an error occurred. Operation will only work when there is no error. If you want to operate a system regardless of errors, you can just inactivate the function.

(d) Signal from Speed Control by each Axis

According to exercise from “Chapter 7.1.2 Current State Reading,” it is a signal of “Speed Control state” for each axis. It turns on when it is operating. Speed/Position Switching Control Setting can only be configured while it is running. If you execute Speed/Position Switching Control while it is not running, the “error 302” would be appeared.

(e) Address of Positioning Module

In this example, Positioning Module is fixed at the 1 slot of 0 bases.

(f) Axis of command execution

You can set an axis for Parameter Setting. UP type supports for 4 axes. In the “execution of axis” from the configuration of Parameter Setting, you can set a value for axis1 through axis4.

(g) State of Operation complete

If function block is completed without error, "1" will be outputted and maintain "1" until the next operation. If error occurred, "0" will be outputted.

(h) Error State

This is the area that output error no. if there are errors in operation of function block.

(i) For more information, reference of Speed/Position Switching Control is in the "Chapter 8.2.14."

(5) Position Specified Speed/Position Switching Control

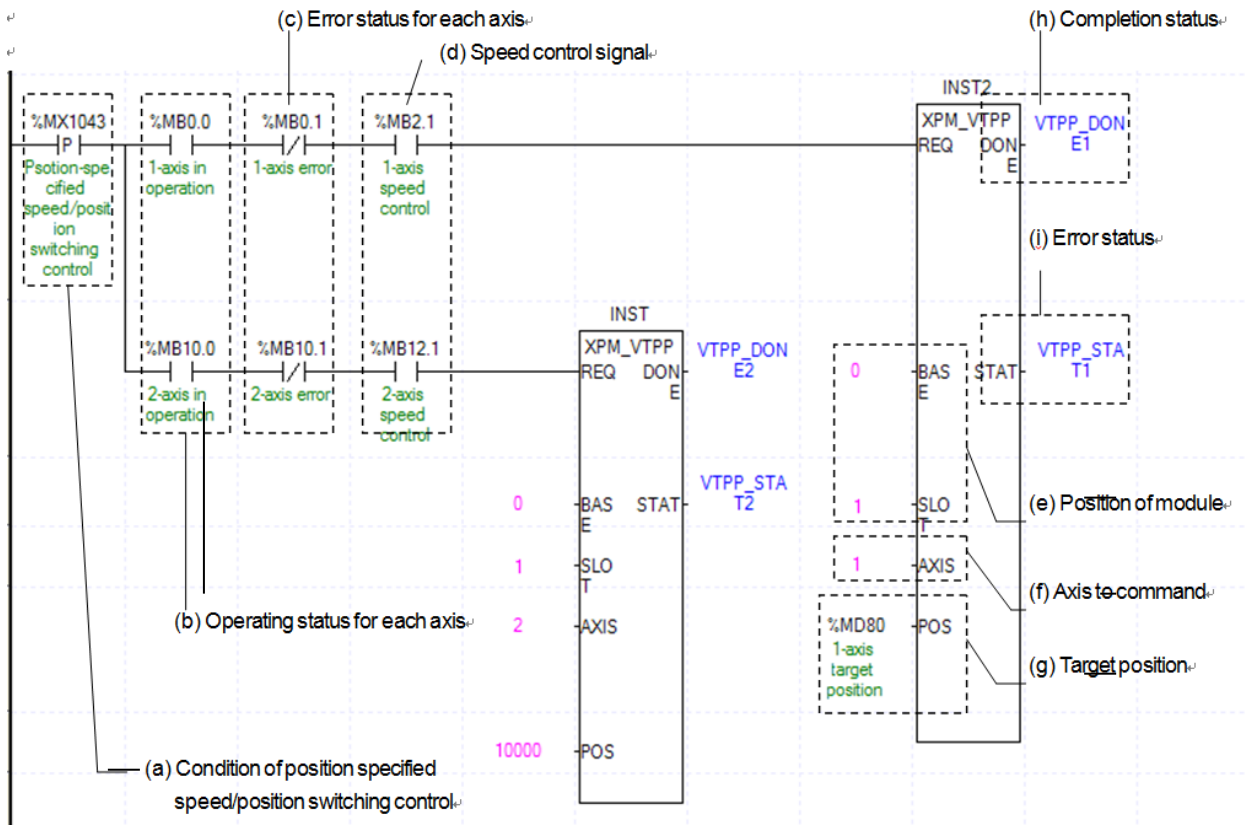

(a) Condition to perform "position-specified speed/position switching control"

Condition to perform control command (XPM_VTPP) for position-specified speed/position switching

(b) Operation state for each axis

In case that an example program of "7.1.2 Read Current State" is applied, it is a signal showing that each axis is "operating." If a relevant axis is running, it becomes 'On'. A condition has been set to make the control command for position specified speed/position switching valid only when the relevant axis is running. If the control command for position specified switching is carried out when the relevant axis is not running, No.301 Error will take place.

(c) Error State for each axis

In case that an example program of "7.1.2 Read Current State" is applied, it is a signal showing "Error State" for each axis. If any error takes place, it becomes 'On'. A condition has been set to perform a control command only when there is no error with the relevant axis. If the user wants to execute a command regardless of the occurrence of errors, he/she may remove this condition.

(d) Speed Control Signal for each axis

In case that an example program of "7.1.2 Read Current State" is applied, it is a signal showing each axis

is “controlling its speed.” If the relevant axis is running under speed control, it becomes ‘On.’ A condition has been set to make the control command for position specified speed/position switching control valid only when the relevant axis is in a speed control status. If the control command is carried out when the relevant axis is not in a speed control status, No.302 Error will take place.

(e) Position of a module

For the example program above, it is assumed that positioning modules are installed on NO.0 Base and No. 1 Slot.

(f) Axis to make a command

Decide an axis that will execute the control command. UP type can control up to four axes and assign 1 through 4 referring to 1-axis through 4-axis for this item.

(g) Transfer amount

After the control command for position specified speed/position control switching is executed, convert from speed control to position control and moves by transfer amount.

(h) Completion state

If any function block is completely executed without any error, it displays and maintains “1” until the next execution while it displays “0” if any error takes place.

(i) Error state

If any error takes place when any function block is executed, this area generates its error number.

(j) For details on the operation of position specified speed/position switching control, refer to “8.2.15 position specified speed/position switching control”

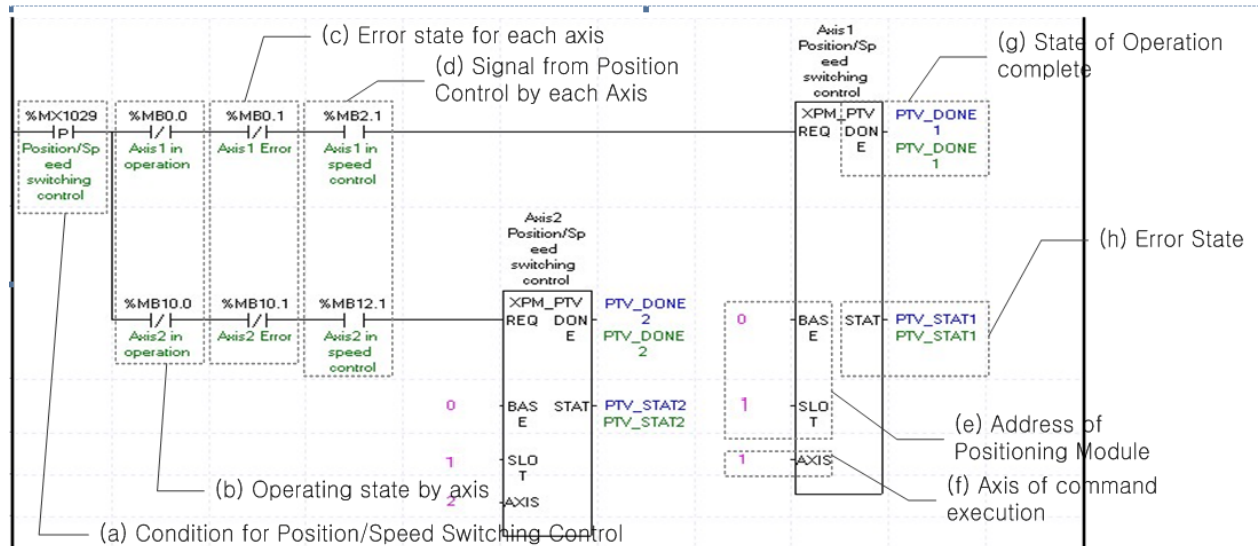
(6) Position/ Speed Switching Control

- (a) This is the condition for Position/ Speed Switching Control
This is the condition for Position/ Speed Switching Control Command (XPM_PTV)
- (b) Operating state by axis
According to exercise from “Chapter 7.1.2 Current State Reading,” it is a signal of “Operating” for each axis. It turns on when it is operating. Operating Data Setting can not be configured while it is running hence configuration will only be configured when it is not running. If you execute Position/ Speed Switching Control while it is running, the “error 311” would be appeared.
- (c) Error state for each axis
According to exercise from “Chapter 7.1.2 Current State Reading,” it is a signal of “Error state” for each axis. It turns on when an error occurred. Operation will only work when there is no error. If you want to operate a system regardless of errors, you can just inactivate the function.
- (d) Signal from Position Control by each Axis
According to exercise from “Chapter 7.1.2 Current State Reading,” it is a signal of “Position Control state” for each axis. It turns on when it is operating. Position/ Speed Switching Control Setting can only be configured while it is running. If you execute Position/Speed Switching Control while it is not running, the “error 317” would be appeared.
- (e) Address of Positioning Module
In this example, Positioning Module is fixed at the 1 slot of 0 bases.
- (f) Axis of command execution
You can set an axis for Parameter Setting. UP type supports for 4 axes. In the “execution of axis” from the configuration of Parameter Setting, you can set a value for axis1 through axis4.
- (g) State of Operation complete
If function block is completed without error, “1” will be outputted and maintain “1” until the next operation. If error occurred, “0” will be outputted.
- (h) Error State
This is the area that output error no. if there are errors in operation of function block.
- (i) For more information, reference of Position/ Speed Switching Control is in the “Chapter 9.2.15.”

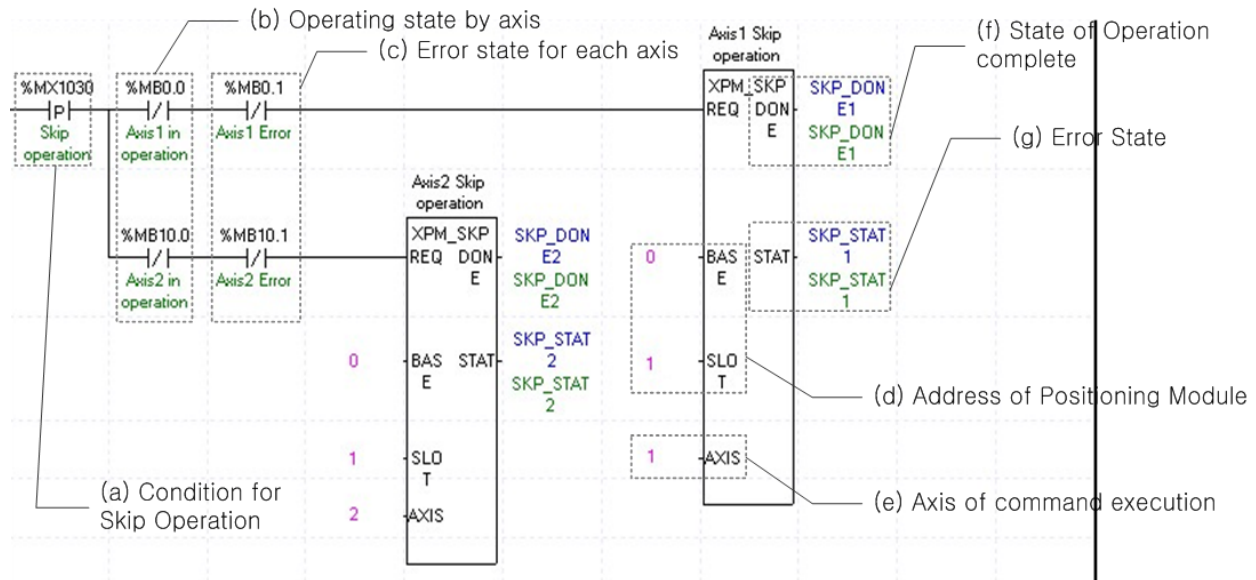
(7) Skip Operation

(a) This is the condition for Skip Operation

This is the condition for Skip Operation Command (XPM_SKP) Once Skip Operation is executed, current operation step is stop and will go to operate with next step.

(b) Operating state by axis

According to exercise from "Chapter 7.1.2 Current State Reading," it is a signal of "Operating" for each axis. It turns on when it is operating. Operating Data Setting can not be configured while it is running hence configuration will only be configured when it is not running. If you execute Skip Operation while it is running, the "error 331" would be appeared.

(c) Error state for each axis

According to exercise from "Chapter 7.1.2 Current State Reading," it is a signal of "Error state" for each axis. It turns on when an error occurred. Operation will only work when there is no error. If you want to operate a system regardless of errors, you can just inactivate the function.

(d) Address of Positioning Module

In this example, Positioning Module is fixed at the 1 slot of 0 bases.

(e) Axis of command execution

You can set an axis for Parameter Setting. UP type supports for 4 axes. In the "execution of axis" from the configuration of Parameter Setting, you can set a value for axis1 through axis4.

(f) State of Operation complete

If function block is completed without error, "1" will be outputted and maintain "1" until the next operation. If error occurred, "0" will be outputted.

(g) Error State

This is the area that output error no. if there are errors in operation of function block.

(h) For more information, reference of Skip Operation is in the "Chapter 9.5.3."

(9) Current Step Change (Start Step Number Change)

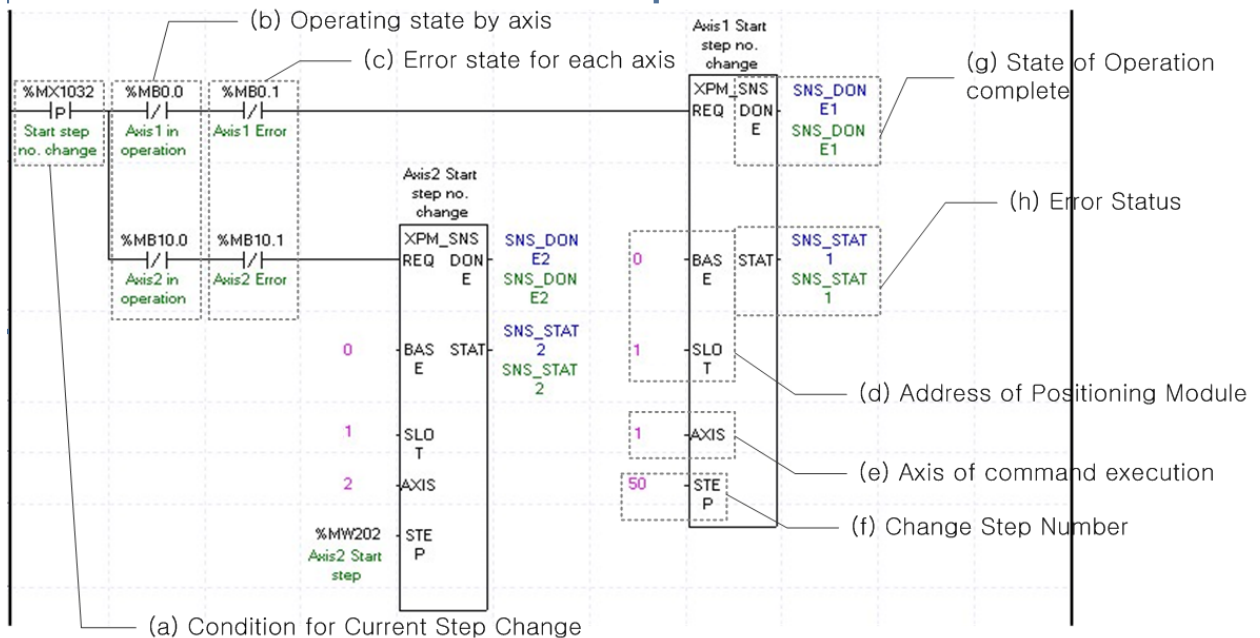

(a) This is the condition for Current Step Change

This is the condition for Current Step Change Command (XPM_SNS). Once Current Step Change is executed, current operation step will move set step.

(b) Operating state by axis

According to exercise from "Chapter 7.1.2 Current State Reading," it is a signal of "Operating" for each axis. It turns on when it is operating. Operating Data Setting can not be configured while it is running hence configuration will only be configured when it is not running. If you execute Current Step Change while it is running, the "error 441" would be appeared.

(c) Error state for each axis

According to exercise from "Chapter 7.1.2 Current State Reading," it is a signal of "Error state" for each axis. It turns on when an error occurred. Operation will only work when there is no error. If you want to operate a system regardless of errors, you can just inactivate the function.

(d) Address of Positioning Module

In this example, Positioning Module is fixed at the 1 slot of 0 bases.

(e) Axis of command execution

You can set an axis for Parameter Setting. UP type supports for 4 axes. In the "execution of axis" from the configuration of Parameter Setting, you can set a value for axis1 through axis4.

(f) Change Step Number

Set change step number by Current Step Change. UP type support 400 step operation data for each Axis. Therefore, the range of step number setting of Current Step Change is 1~400.

(g) State of Operation complete

If function block is completed without error, "1" will be outputted and maintain "1" until the next operation. If error occurred, "0" will be outputted.

(h) Error State

This is the area that output error no. if there are errors in operation of function block.

(i) For more information, reference of Current Step Change is in the "Chapter 8.5.9."

(10) Repeat Step No. Change

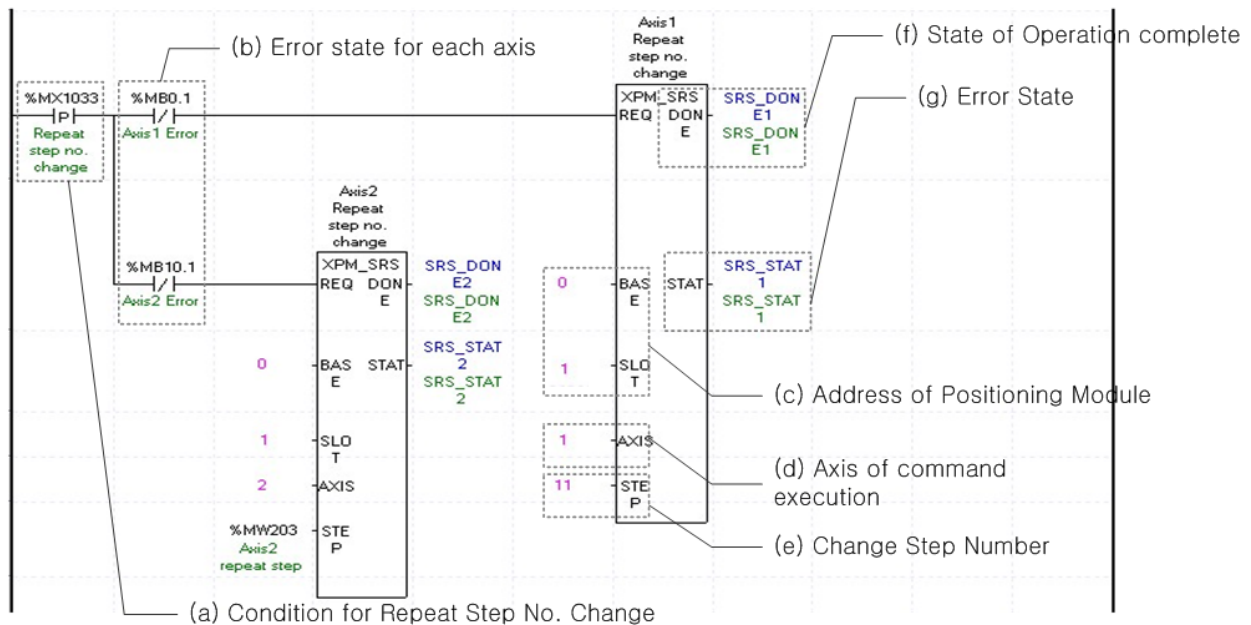

(a) This is the condition for Repeat Step No. Change

This is the condition for Repeat Step No. Change Command (XSRS). Once Repeat Step No. Change is executed, current operation step will move set step. It will execute a operation when set of Operation Method is "Repeat."

(b) Error state for each axis

According to exercise from "Chapter 7.1.2 Current State Reading," it is a signal of "Error state" for each axis. It turns on when an error occurred. Operation will only work when there is no error. If you want to operate a system regardless of errors, you can just inactivate the function.

(c) Address of Positioning Module

In this example, Positioning Module is fixed at the 1 slot of 0 bases.

(d) Axis of command execution

You can set an axis for Parameter Setting. UP type supports for 4 axes. In the "execution of axis" from the configuration of Parameter Setting, you can set a value for axis1 through axis4.

(e) Change Step Number

Set change step number by Current Step Change. UP type support 400 step operation data for each Axis.

Therefore, the range of step number setting of Current Step Change is 1~400. In the example, Axis1 and axis2 are changed to step no.11 and step no. saved in %MW203.

(f) State of Operation complete

If function block is completed without error, "1" will be outputted and maintain "1" until the next operation. If error occurred, "0" will be outputted.

(g) Error State

This is the area that output error no. if there are errors in operation of function block.

(h) For more information, reference of Repeat Step No. Change is in the "Chapter 9.5.10."

(11) Current Position Preset

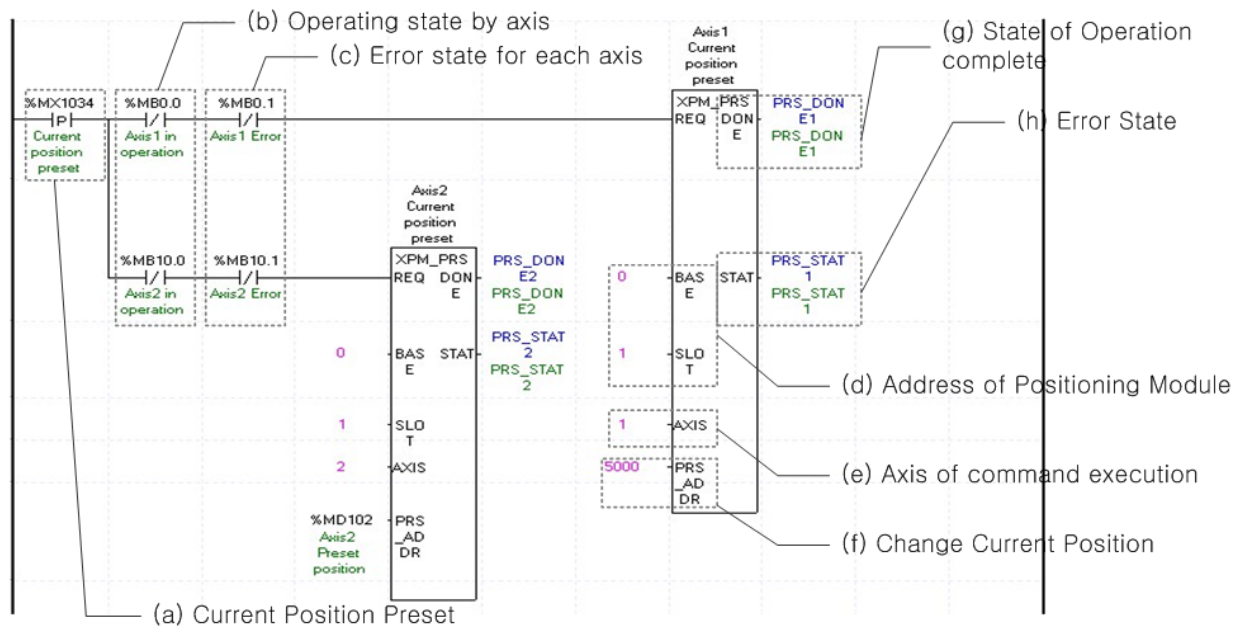

(a) This is the condition for Current Position Preset

This is the condition for Current Position Preset Command (XPM_SNS). Once Current Position Preset is executed, current operation step will move to set step. If the origin has not set yet, the origin would be set to origin decided.

(b) Operating state by axis

According to exercise from "Chapter 7.1.2 Current State Reading," it is a signal of "Operating" for each axis. It turns on when it is operating. Operating Data Setting can not be configured while it is running hence configuration will only be configured when it is not running. If you execute Current Position Preset while it is running, the "error 451" would be appeared.

(c) Error state for each axis

According to exercise from "Chapter 7.1.2 Current State Reading," it is a signal of "Error state" for each axis. It turns on when an error occurred. Operation will only work when there is no error. If you want to operate a system regardless of errors, you can just inactivate the function.

(d) Address of Positioning Module

In this example, Positioning Module is fixed at the 1 slot of 0 bases.

(e) Axis of command execution

You can set an axis for Parameter Setting. UP type supports for 4 axes. In the "execution of axis" from the configuration of Parameter Setting, you can set a value for axis1 through axis4.

(f) Change Current Position

Set change current position by Current Position Preset. Unit follows the value from "Unit" of basic parameter. In the example, Axis1 and axis2 are changed to 5000 and the position saved in %MD102.

(g) State of Operation complete

If function block is completed without error, "1" will be outputted and maintain "1" until the next operation. If error occurred, "0" will be outputted.

(h) Error State

Chapter 7 Program

This is the area that output error no. if there are errors in operation of function block.
(j) For more information, reference of Current Position Preset is in the “Chapter 9.5.7.”

(12) Encoder Preset

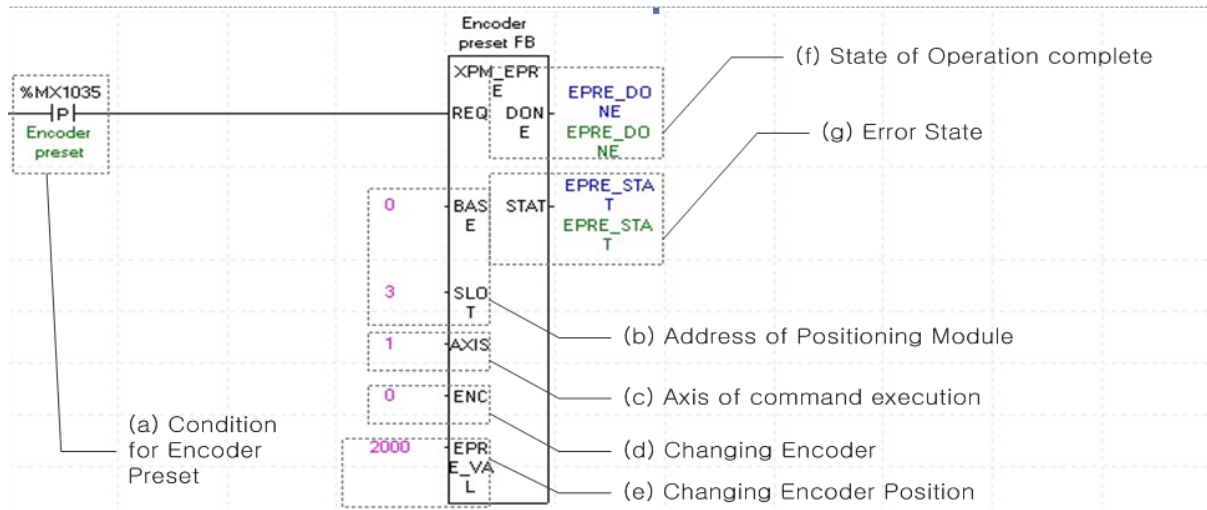

(a) This is the condition for Encoder Preset

This is the condition for Encoder Preset Command (XEPRS). Once Encoder Preset is executed, current operation step will move to set step.

(b) Address of Positioning Module

In this example, Positioning Module is fixed at the 1 slot of 0 bases.

(c) Axis of command execution

You can set an axis for Parameter Setting. UP type supports for 4 axes. In the "execution of axis" from the configuration of Parameter Setting, you can set a value for axis1 through axis4.

(d) Changing Encoder

Set Changing Encoder to execute a preset. XPM always be "0."

(e) Changing Encoder Position

Set for Changing Encoder Position. In the example, the encoder position is changed to 2000.

(f) State of Operation complete

If function block is completed without error, "1" will be outputted and maintain "1" until the next operation. If error occurred, "0" will be outputted.

(g) Error State

This is the area that output error no. if there are errors in operation of function block.

(h) For more information, reference of Encoder Preset is in the "Chapter 8.5.8."

7.1.7 Error

(1) Error Reset

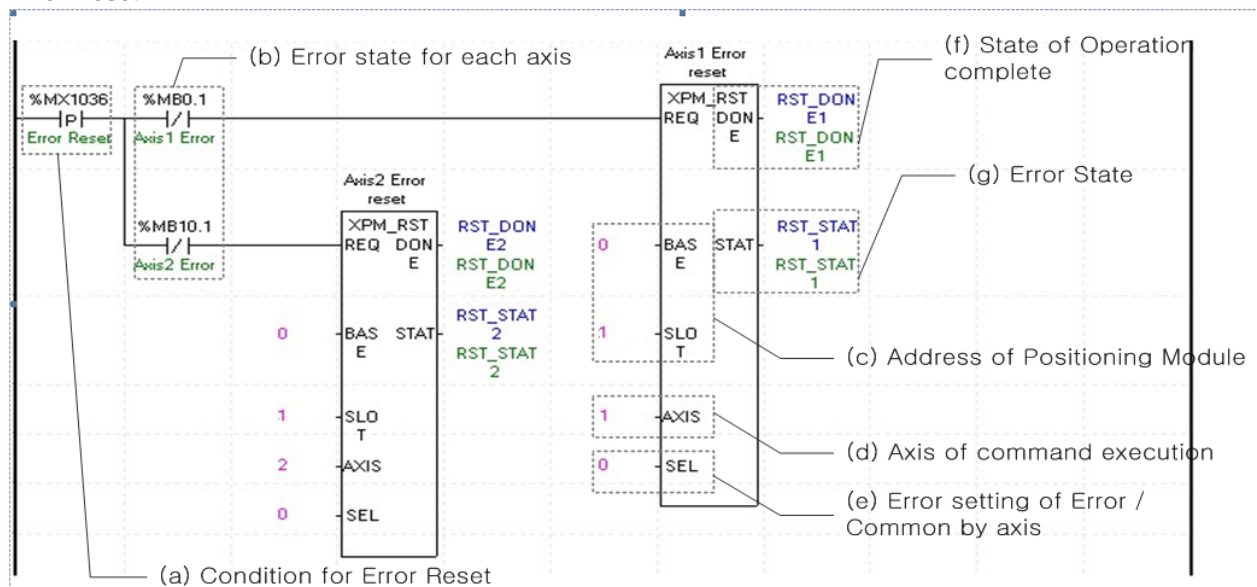

(a) This is the condition for Error Reset

This is the condition for Error Reset Command (XPM_RST). Once Error Reset is executed, it erases errors of module form each axis.

(b) Error state for each axis

According to exercise from “Chapter 7.1.2 Current State Reading,” it is a signal of “Error state” for each axis. It turns on when an error occurred. Operation will only work when there is no error. If you want to operate a system regardless of errors, you can just inactivate the function.

(c) Address of Positioning Module

In this example, Positioning Module is fixed at the 1 slot of 0 bases.

(d) Axis of command execution

You can set an axis for Parameter Setting. UP type supports for 4 axes. In the “execution of axis” from the configuration of Parameter Setting, you can set a value for axis1 through axis4.

(e) Error setting of Error/Common by axis

Depending on the errors, if it is set by “0”, erase the errors in operation of each axis, if it is set by “1”, erase the common errors of each modules.

(f) State of Operation complete

If function block is completed without error, “1” will be outputted and maintain “1” until the next operation. If error occurred, “0” will be outputted.

(g) Error State

This is the area that output error no. if there are errors in operation of function block.

(2) Error History Reset

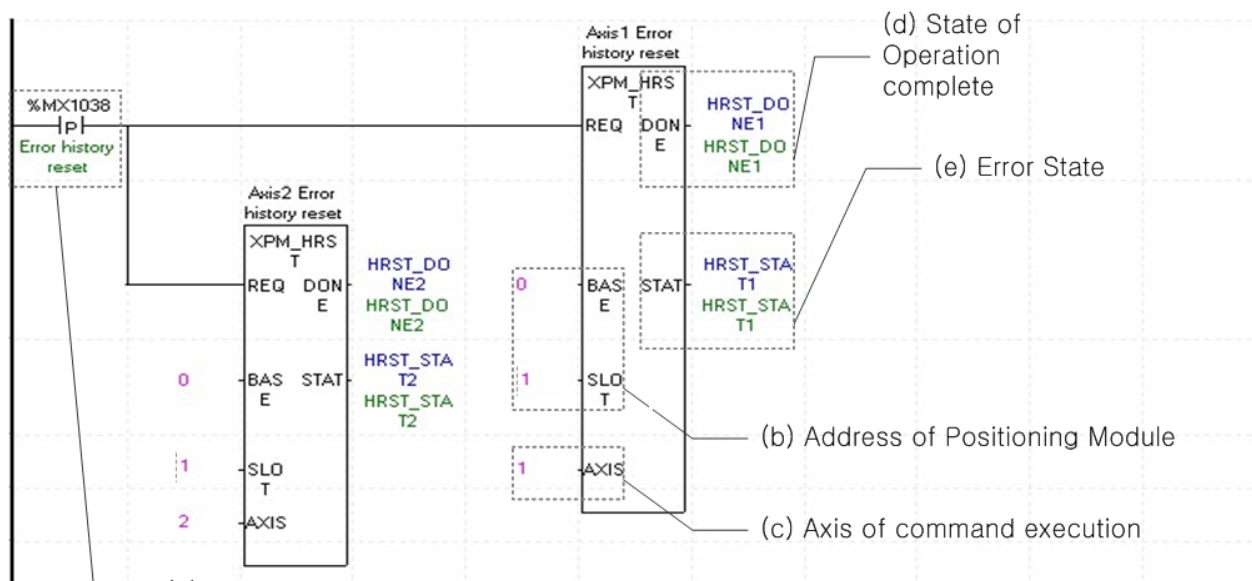

(a) This is the condition for Error History Reset

This is the condition for Error History Reset Command (XPM_HRST). Once Error Reset is executed, it erases history of generated errors of module. UP type has ten error histories by each axis. It will be saved to FRAM, remain still even there is no power.

(b) Address of Positioning Module

In this example, Positioning Module is fixed at the 1 slot of 0 bases.

(c) Axis of command execution

You can set an axis for Parameter Setting. UP type supports for 4 axes. In the "execution of axis" from the configuration of Parameter Setting, you can set a value for axis1 through axis 4.

(d) State of Operation complete

If function block is completed without error, "1" will be outputted and maintain "1" until the next operation. If error occurred, "0" will be outputted.

(e) Error State

This is the area that output error no. if there are errors in operation of function block.

Chapter 8 Functions

8.1 Homing

Homing is carried out to confirm the origin of the machine when applying the power. In case of homing, it is required to set homing parameter per axis. If the origin position is determined by homing, the origin detection signal is not recognized during positioning operation.

8.1.1 Homing method

(1) Methods using DOG signal

- (a) Origin detection after DOG "Off" (0:DOG /HOME(Off))
- (b) Origin detection after deceleration when DOG "On" (1: DOG /HOME(On))
- (c) Origin detection by DOG (3: DOG)

(2) Methods without using DOG signal

- (a) Origin detection by Home and upper/lower limit (2: U.L.Limit /Home)
 - (b) High speed Homing (4: High speed)
 - (c) Origin detection by upper/Lowerlimit (5: Upper/Lower limit)
 - (d) Origin detection by Home (6: Home)
- ※ () is homing parameter selection item of XG-PM software package.

8.1.2 Parameters for Homing

- (1) Home position
- (2) Home high speed
- (3) Home low speed
- (4) Homing acceleration time
- (5) Homing deceleration time
- (6) Homing dwell time
- (7) Origin compensation amount
- (8) Homing reset waiting time
- (9) Homing mode
- (10) Homing Direction

※ For further information about homing parameters and setting value, please refer to Chapter 4.

8.1.3 Origin Detection after DOG Off (0: DOG /HOME(Off))

This is the method using the DOG and HOME signal and the action by homing command is as follows.

(1) Operation

- Accelerates to the setting homing direction and acts by homing high speed.
- At the rising edge DOG signal it decelerates and acts by homing low speed.
- If HOME signal is entered after the DOG signal has changed from "On" to "Off", the origin shall be determined and it stops pulse output.

■ Operating Pattern

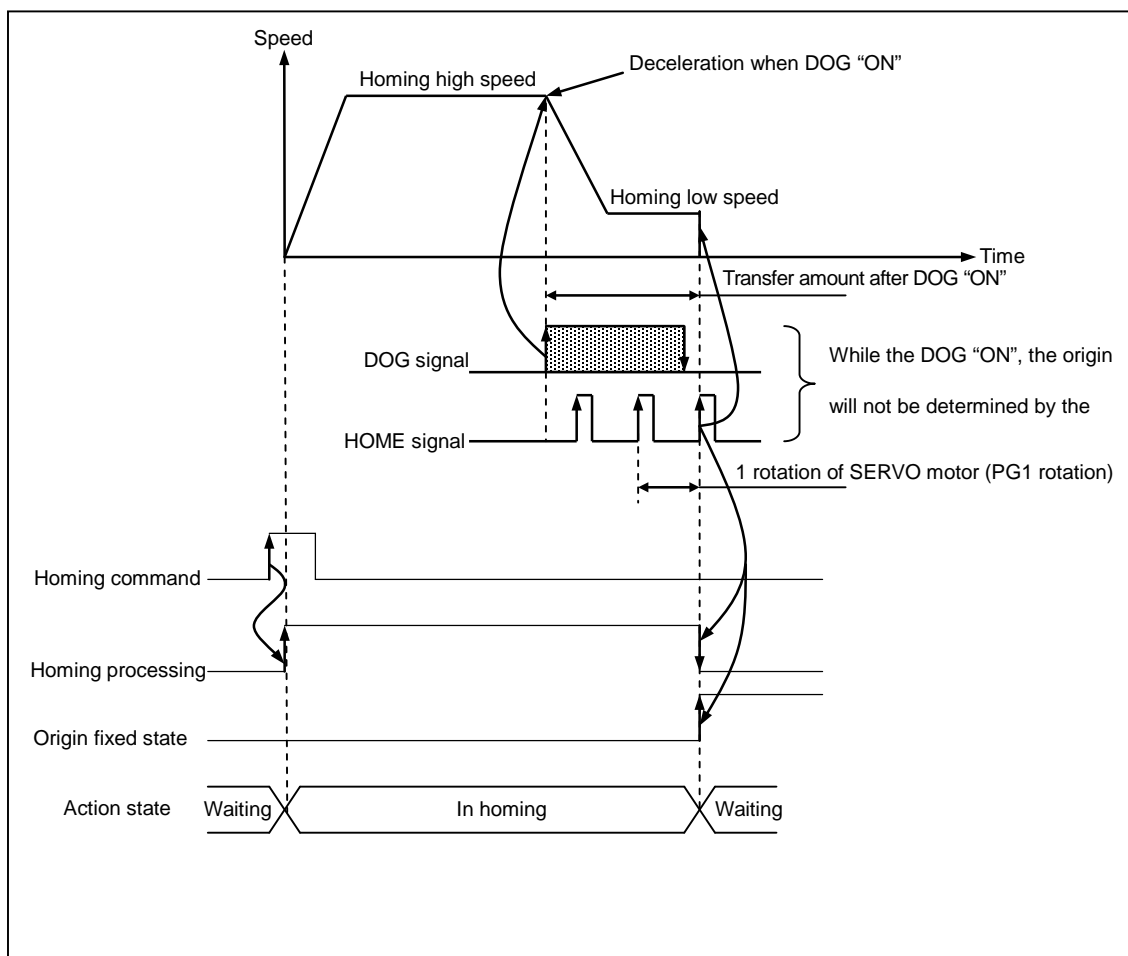

Chapter 8 Functions

NOTE

1. While DOG signal maintains "On", the origin will not be determined by HOME signal.
That is, when DOG signal changes from "Off" to "On"(acceleration section -> homing high speed) , from "On" to "Off" (deceleration section -> homing low speed) and then when the HOME changes from "Off" to "On", the origin will be determined.

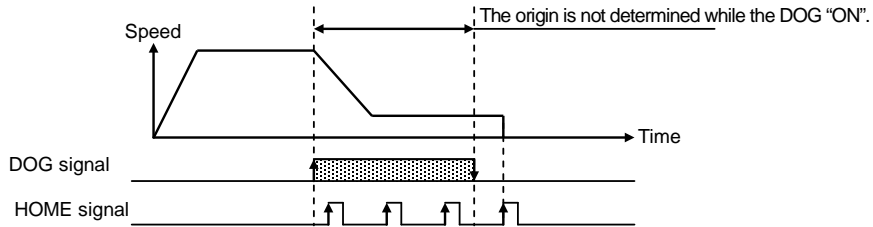

2. While the homing speed acts to the deceleration section by homing high speed after the DOG signal is changed from "Off" to "On", from "On" to "Off", the origin will not be determined even if encounters the HOME input.

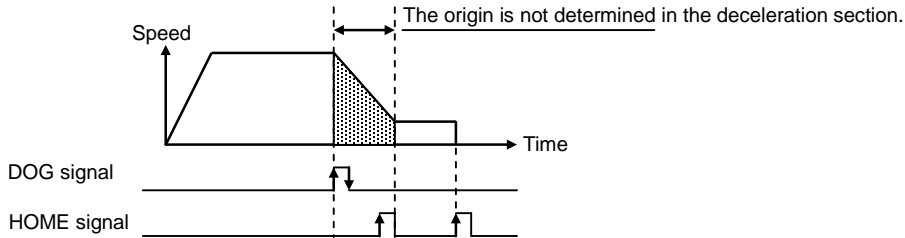

3. If the DOG signal is changed from "Off" to "On", from "On" to "Off" and encounters external upper/lower limit while waiting the HOME input, the action is as follow.

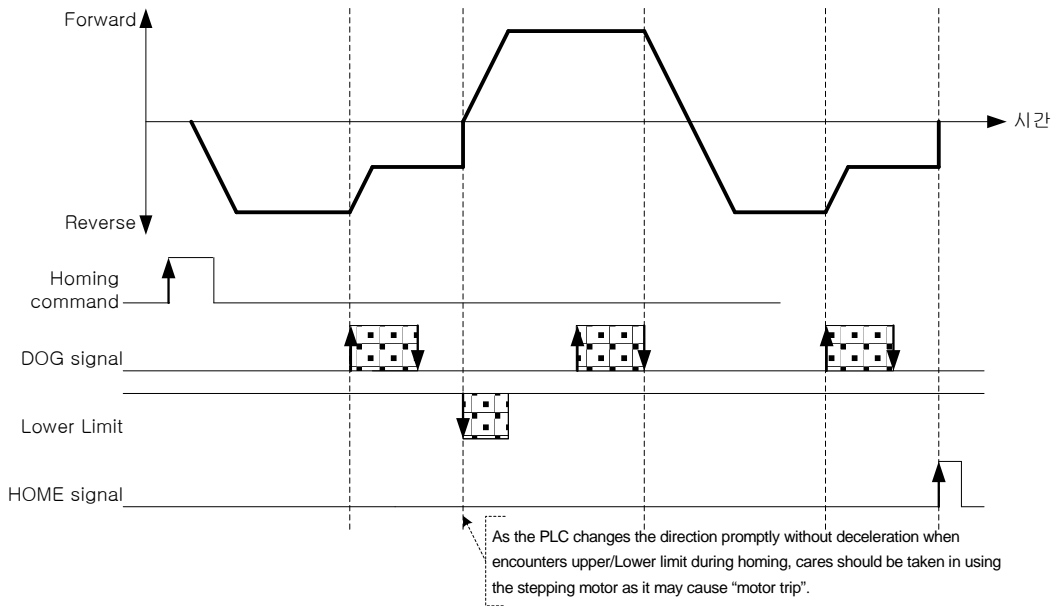

4. If "On" time of the origin is too short, the positioning module can not recognize it.

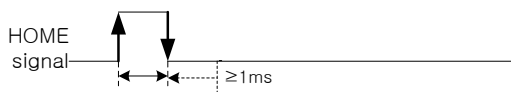

8.1.4 Origin Detection after Deceleration when DOG On(1: DOG /HOME(On))

This is the method using the DOG and HOME signal and the action by homing command is as follows.

(1) Operation

- Accelerates to the setting homing direction and acts by homing high speed.
- At the rising edge DOG signal it decelerates and acts by homing low speed.
- while the DOG signal is "On" and the homing low speed is active, the origin shall be determined if HOME signal is entered.

■ Operating Pattern

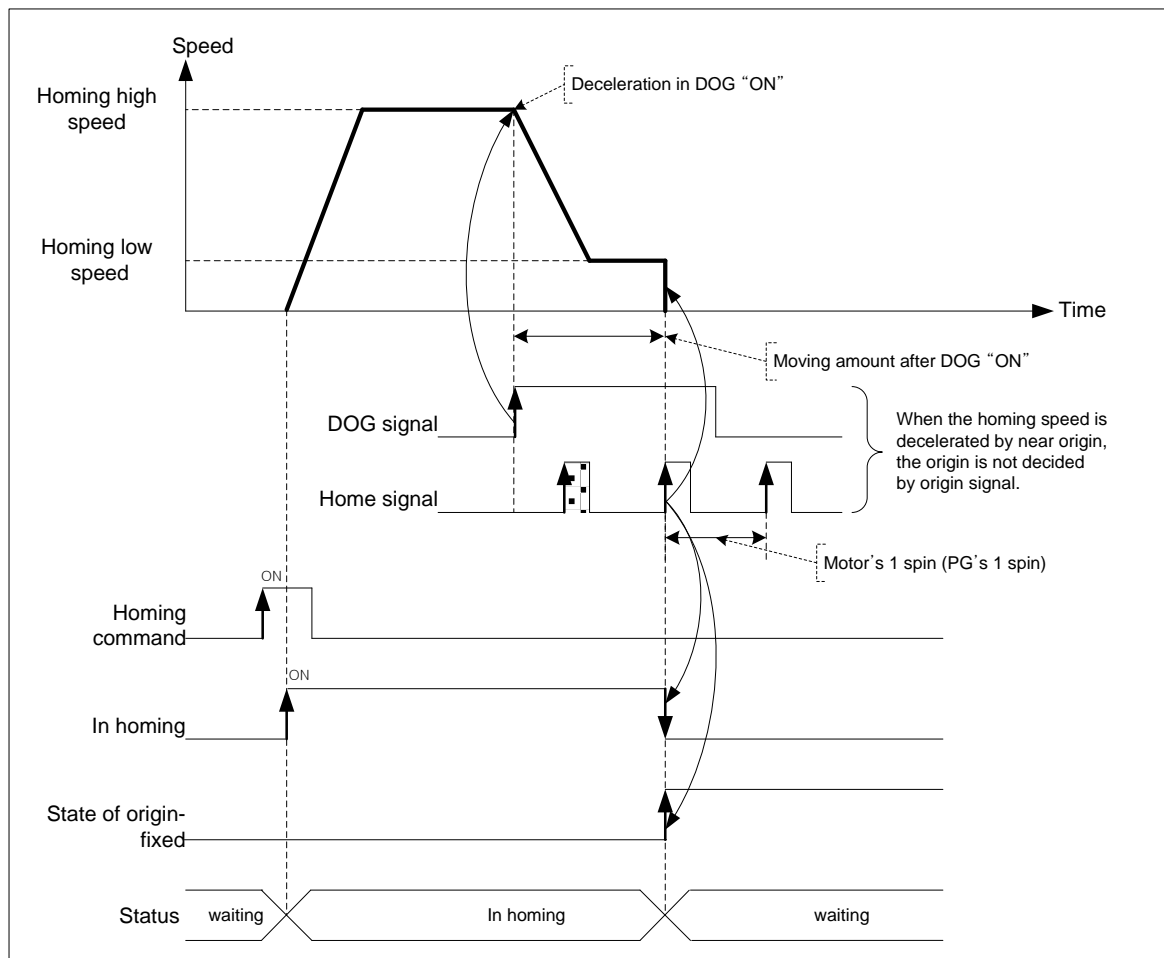

Note

- Once the DOG signal is "On", when the homing speed acts from high speed to low speed via deceleration section, if the HOME is entered in the state that the DOG signal is "ON", the origin will be determined promptly. That is, The origin will not be determined by the HOME signal during the decelerating.
- When encounters the Upper/Lower limit signal before HOME after the DOG signal has changed from "Off" to "On", the action will be the same as the method of Article 8.1.3
- If "On" time of HOME signal is short, the positioning module can not recognize it.

Chapter 8 Functions

8.1.5 Origin Detection by Origin and High/Low Limit (2: U.L Limit/Home)

This is the method using the DOG and HOME and the action by homing command is as follows.

(1) Operation

- (a) Accelerates to the setting homing direction and acts by homing high speed.
- (b) If Upper/Lower signal is entered, it transferred to opposite direction and acts by homing low speed.
- (c) If encounters the HOME signals while the homing low speed is active, the origin would be determined and it stops..

■ Operating Pattern

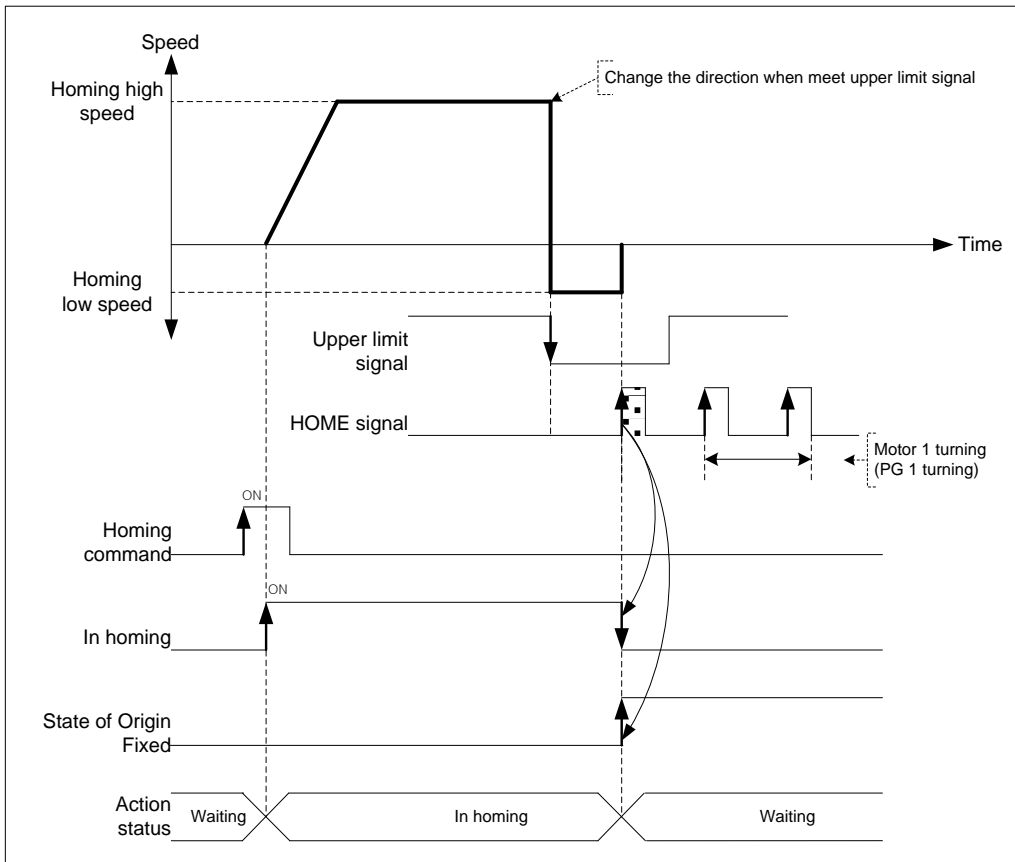

Note

In case that HOME signal is "ON" before entering the Upper/Lower limit signal, it carries out the homing low speed operation when the Upper/Lower limit signal is entered and when HOME is "ON", the origin will be determined

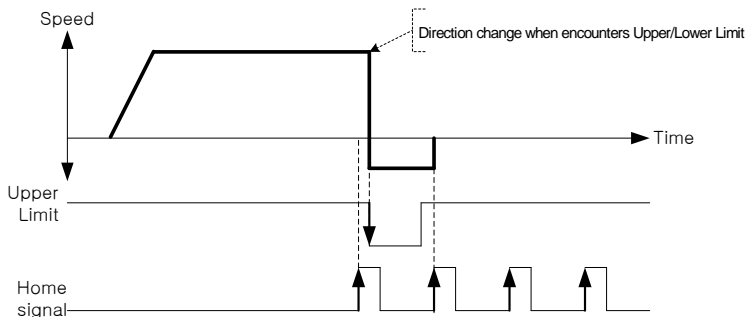

8.1.6 Origin Detection by DOG signal (3: DOG)

This is used when determines the origin only by using the DOG signal.

(1) Operation

- Accelerates to the setting homing direction and acts by homing high speed.
- If DOG signal is entered, it decelerates and transferred to opposite direction acts by homing high speed.
- When it operates in opposite direction, if DOG is entered again, it decelerates and transferred to opposite direction and acts by homing low speed.
- If encounters the DOG signals again while the homing low speed is active, the origin would be determined and it stops..

■ Operating Pattern

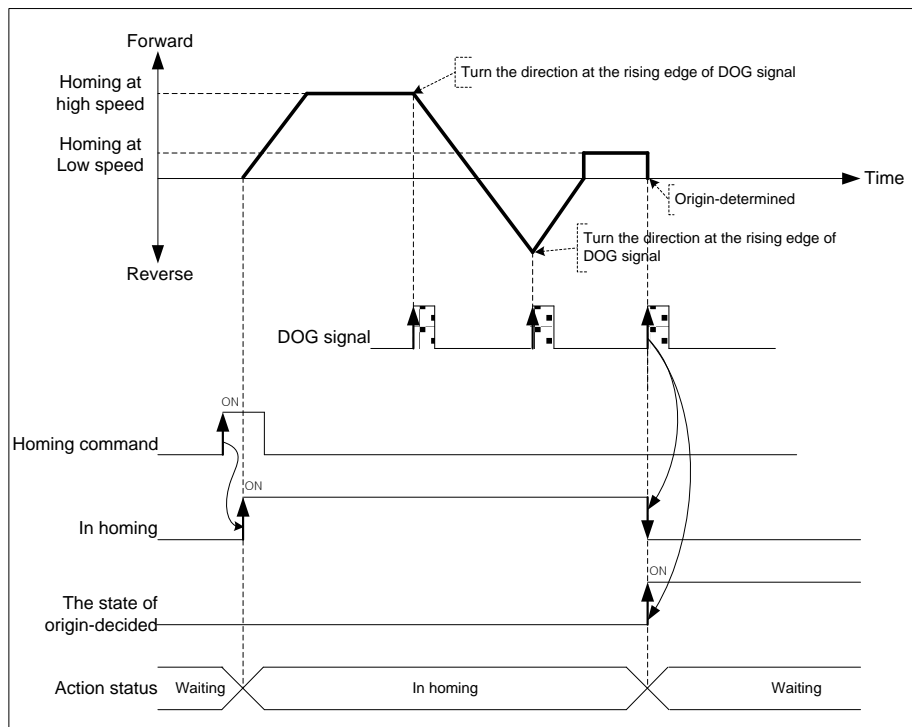

Note

If "ON" time of DOG is longer than deceleration time, the action is as follows.

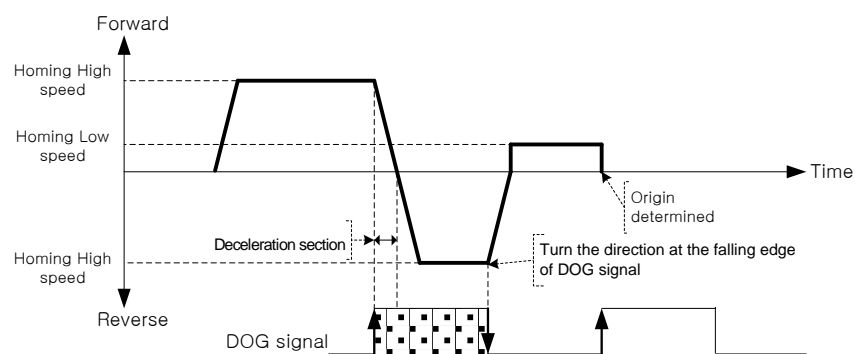

8.1.7 High Speed Homing (4: High Speed)

High speed origin detection is one of the homing methods that returns to the origin determination position without detection of external signal (DOG, HOME, Upper/Lower limit) when returning to the mechanical origin position after completion of the mechanical homing.

(1) Operation

- (a) Once Homing command executes, it operates positioning with high speed and homing from current position
- (b) When using High speed homing, it should be carried out in the state that the positioning by 6 types of mechanical homing, by floating origin, or by the current position preset is completed in advance.

■ Operating Pattern

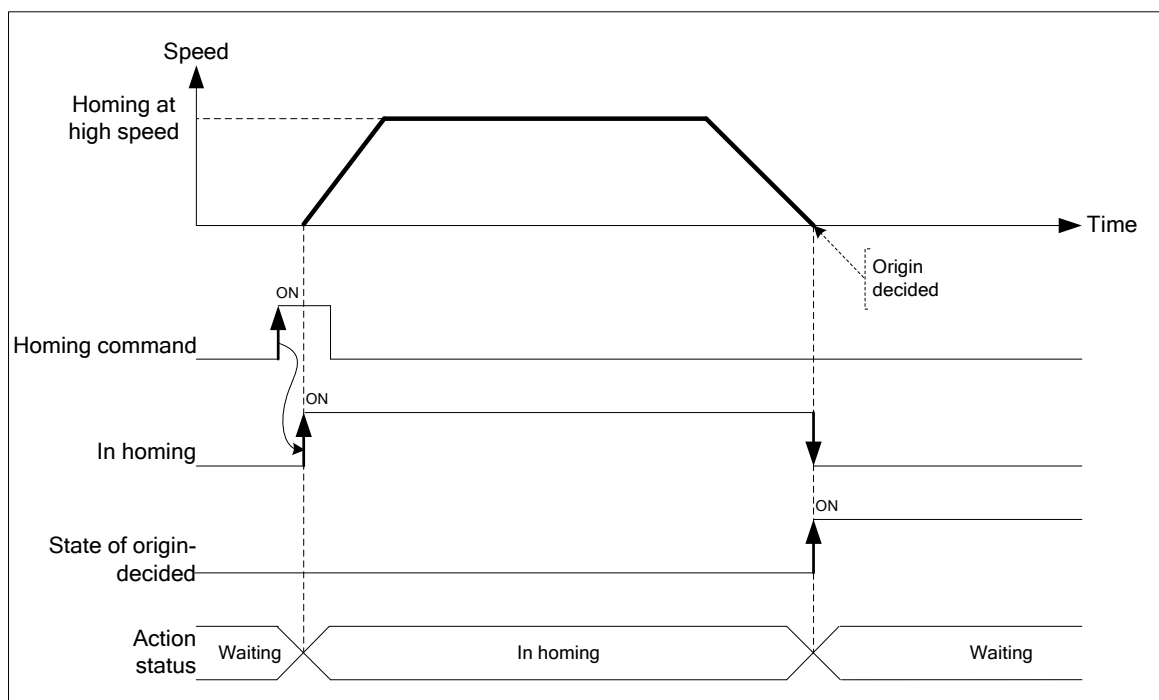

8.1.8 Origin Detection by Upper/Lower Limit (5: Upper/Lower Limit)

This is the homing method using the Upper/Lower limit signal and is used when not using the HOME or DOG signal .

(1) Operation

- It accelerates to the setting homing direction and acts by homing high speed.
- If Upper/Lower limit signal is entered, it transferred to opposite direction and acts by homing low speed.
- If Upper/Lower limit signal is turned off while the homing low speed is active, the origin would be determined and it stops.

■ Operating Pattern

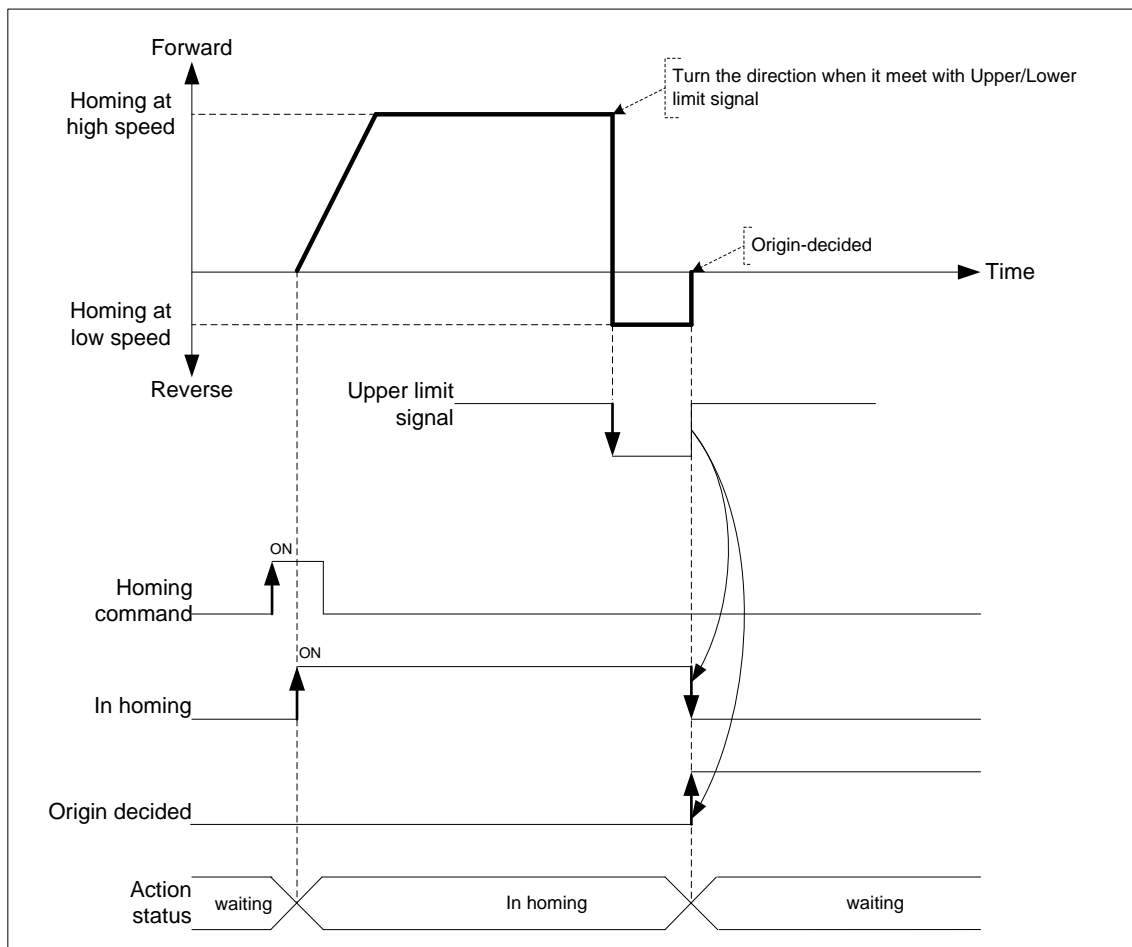

Chapter 8 Functions

8.1.9 Origin Detection by HOME (6: Home)

This is used when determines the origin only by using the HOME signal.

(1) Operation

- It accelerates to the setting homing direction and acts by homing high speed.
- In this case, if HOME signal is entered, it decelerates and transferred to opposite direction acts by homing high speed.
- When it operates in opposite direction, if HOME is entered again, it decelerates and transferred to opposite direction and acts by homing low speed.
- If encounters the HOME signals again, the origin would be determined and it stops.

■ Operating Pattern

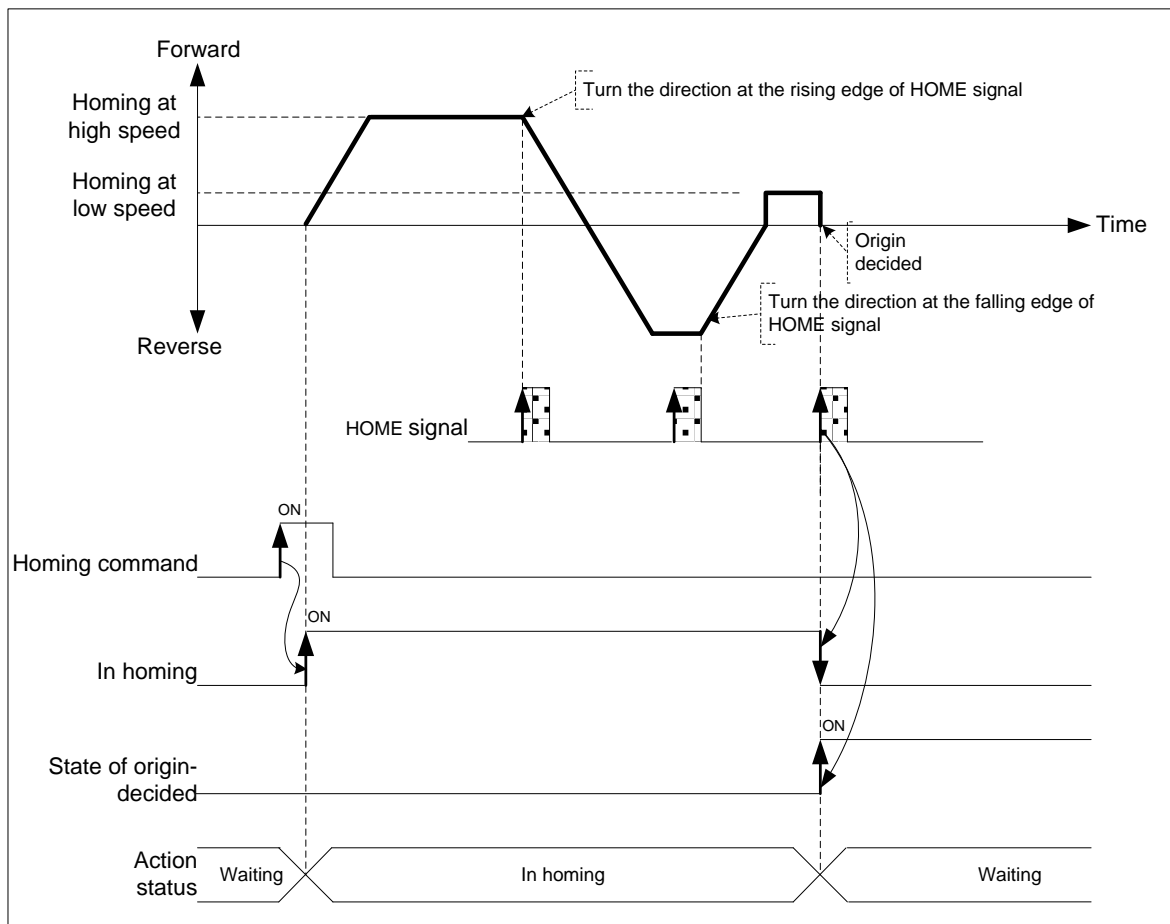

Note

1. If "ON" time of DOG is longer than deceleration time, the action is as follows

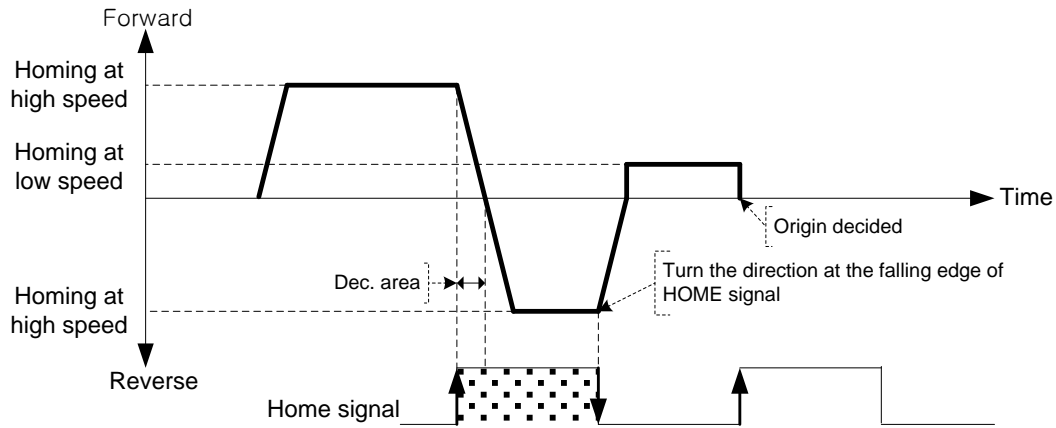

2. It acts as follows if Lower limit (if homing direction is forward, upper limit) signal is entered before HOME signal is entered..

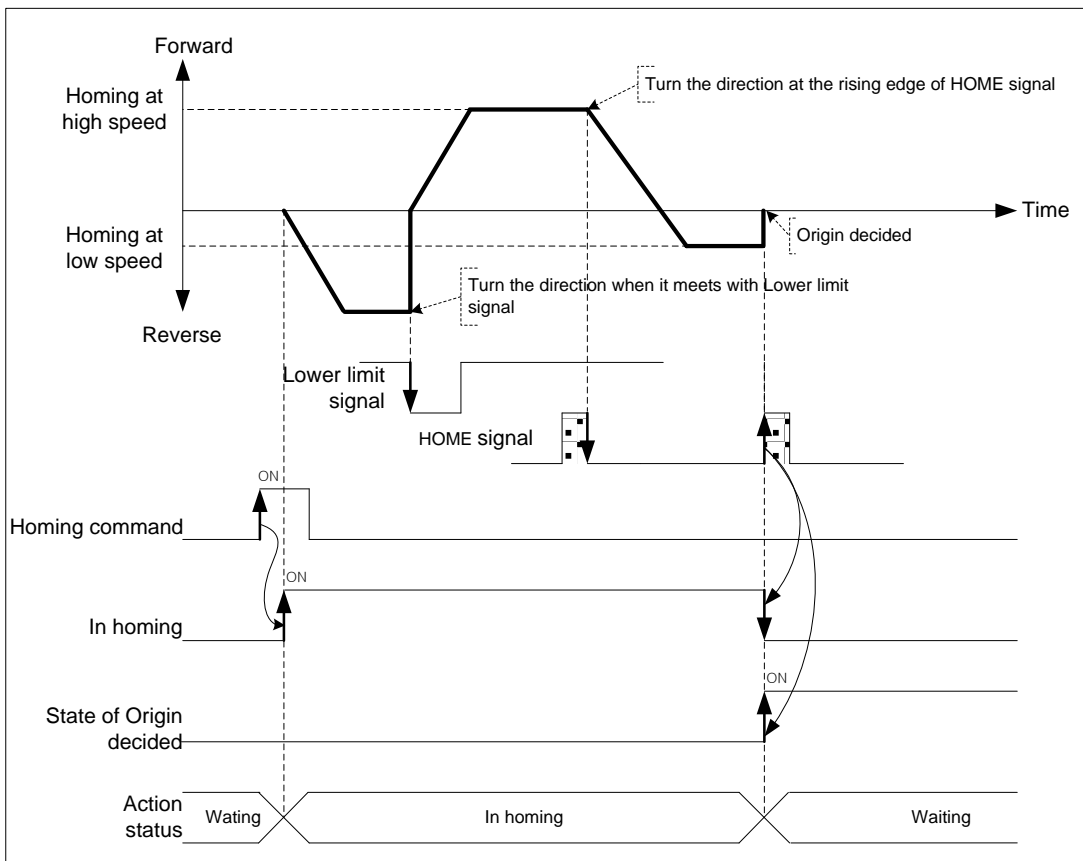

Chapter 8 Functions

8.2 Positioning Control

Positioning control execute using data which set on the 「Operation Data」. Positioning Control includes Single-axis Position control, Single-axis Speed Control, Single-axis Feed Control, Interpolation control, Speed/Position Switching control, Position/Speed Switching control.

Positioning Control		Control Method	Operation
Positioning Control	Single-axis Position Control	Absolute, Single-axis Position Control Incremental, Single-axis Position Control	Specified axis executes positioning control from the beginning (current position) to the goal position.
	Single-axis Feed Control	Absolute, Single-axis Feed Control Incremental, Single-axis Feed Control	The starting position (the current stop position), changes to 0 and executes positioning control as much as setting amount of movement. .
	Linear Interpolation	Absolute, Linear Interpolation Incremental, Linear Interpolation	Executing linear interpolation control by using starting address (current stop position) from the axis (2 axes or more) to the target position.
	Circular Interpolation	Absolute, Circular Interpolation Incremental, Circular Interpolation	Execute positioning control until goal position by the trajectory of arc and control sub-axis as using axis-2 according to data of main axis.
	Helical Interpolation		Set by helical interpolation axis, execute linear interpolation control until goal position by the trajectory of arc and control sub-axis as using axis-3 according to data of main axis.
	Ellipse Interpolation		Execute positioning control until goal position by trajectory angle of the ellipse is set to operate and control sub-axis as using axis- 2 according to data of main axis.
Speed Control		Absolute, Single-axis Speed Control Incremental, Single-axis Speed Control	Execute Speed control as setting speed until deceleration stop command is entered.
Speed/Position Switching Control		Absolute, Single-axis Speed Control Incremental, Single-axis Speed Control	Speed controlling and then speed / position switching command or speed / position control switching input signal is entered, speed control switch to position control and execute positioning control as much as target position.
Position/Speed Switching Control		Absolute, Single-axis Position Control Incremental, single-axis Position Control	Position controlling and then position / speed switching command is executed, position control switch to speed control and execute speed control as setting speed until deceleration stop command is entered.

8.2.1 Operation Data for Positioning Control

Describe the Operation data and Setting to execute positioning control.

Operation Data	Setting
Control Method	Set the Type of control and Standard coordinates of Positioning control.
Operation Method	Set the control method of continuous operation data.
Goal Position	Set the absolute target position or distance of positioning control.
Operation Speed	Set the value of operation speed during operation control.
Acceleration Number	Set the operation number of operation control during acceleration time. Acceleration Number is selected from basic parameters which are Acceleration Number1, 2, 3, and 4.
Deceleration Number	Set the operation number of operation control during deceleration time. Deceleration Number is selected from basic parameters which are Deceleration Number1, 2, 3, and 4.
M Code	Set the M Code when using the code number for sub operation of positioning control.
Dwell Time	After complete the positioning control, set the time until servo drive complete positioning control.
Sub Axis Setting	Set the sub axis during interpolation control.
Circular Interpolation	Set the secondary data (middle point, center point and radius) during circular interpolation.
Circular Interpolation Mode	Set the generating method of arc (middle point, center point and radius) during circular interpolation.
Circular Interpolation Turn Number	Set the number of arcs to draw during circular interpolation.
Helical Interpolation	Set the axis to run linear operation during helical interpolation.

Note

It is available to set the operation data each of 1~400 steps and axis1~4.

Chapter 8 Functions

8.2.2 Operation mode of Positioning Control

Operation mode describes various configurations for how to operate the positioning data using several operation step no. and how to determine the speed of position data.

Operation mode types are as follows

Control Method	Operation Method	Operation Pattern	Executable	Operation
Single-axis Position Control	Single	End	○	Finish after the completion of the current step position control
		Keep	○	Continue to the next step after the completion of the current step position control
		Continuous	○	Continue to the next step continuously without stop.
	Repeat	End	○	Change the step No. to the Repeat step No. after the completion of the current step position control.
		Keep	○	Continue to the repeat step No. after the completion of the current step position control
		Continuous	○	The current step and the repeat step No. continuously without stop
Single-axis Speed Control	Single	End	○	Speed control using current step's DATA
		Keep	○	Speed control using current step's DATA. If VTP command executed, continue to the next step after the completion of the current step's positioning.
		Continuous	X	Errors
	Repeat	End	○	Speed control using current step's DATA
		Keep	○	Speed control using current step's DATA. If VTP command executed, continue to the repeat step No. after the completion of the current step's positioning.
		Continuous	X	Errors
Single-axis FEED Control	Single	End	○	Finish after the completion of the current step's FEED control
		Keep	○	Continue to the next step after the completion of the current step FEED control
		Continuous	X	Errors
	Repeat	End	○	Change the step No. to the Repeat step No. after the completion of the current step FEED control.
		Keep	○	Continue to the repeat step No. after the completion of the current step FEED control
		Continuous	X	Errors
Linear Interpolation	Single	End	○	Finish after the completion of the current step's linear interpolation
		Keep	○	Continue to the next step after the completion of the current step s linear interpolation
		Continuous	○	Continue to the next linear interpolation step continuously without stop
	Repeat	End	○	Change the step No. to the Repeat step No. after the completion of the current step linear interpolation.
		Keep	○	Continue to the repeat step No. after the completion of the current step s linear interpolation
		Continuous	○	The current linear interpolation and the repeat step No. continuously without stop
Circular Interpolation	Single	End	○	Finish after the completion of the current step's circular interpolation
		Keep	○	Continue to the next step after the completion of the current step s circular interpolation
		Continuous	○	Continue to the next circular interpolation step continuously without stop
	Repeat	End	○	Change the step No. to the Repeat step No. after the completion of the current step circular interpolation.
		Keep	○	Continue to the repeat step No. after the completion of the current step s circular interpolation
		Continuous	○	The current circular interpolation and the repeat step No. continuously without stop

Note

1. Operation mode shall be set from PLC Program or Operation data of XG-PM.
2. Operation data can be set up to 400 from operation step no. 1 ~ 400 at each axis.
3. With one time start command, positioning operation method by one operation step positioning data and positioning operation method by several operation step in order shall be determined by operation mode of each positioning data set.
3. With one time start command, positioning operation method by one operation step positioning data and positioning operation method by several operation step in order shall be determined by operation mode of each positioning data set.
4. when executing continuous operation, The continuous operation item of common parameter must be set to "Enable". if Continuous Operation parameter is disabled, Continuous operation command can not be executed

(1) End Operation (Single)

- (a) With one time start command, the positioning to the goal position is executed and the positioning shall be completed at the same time as the dwell time proceeds.
- (b) The positioning completion of this operation mode can be used as operation mode of last positioning data of Keep operation mode and Continuous operation mode.
- (c) Operation direction shall be determined by the value of address.
- (d) Operation action is trapezoid(or S-Curve) type operation that has acceleration, constant, deceleration section according to the setting speed and position data but the operation pattern according to the setting value is as follows.

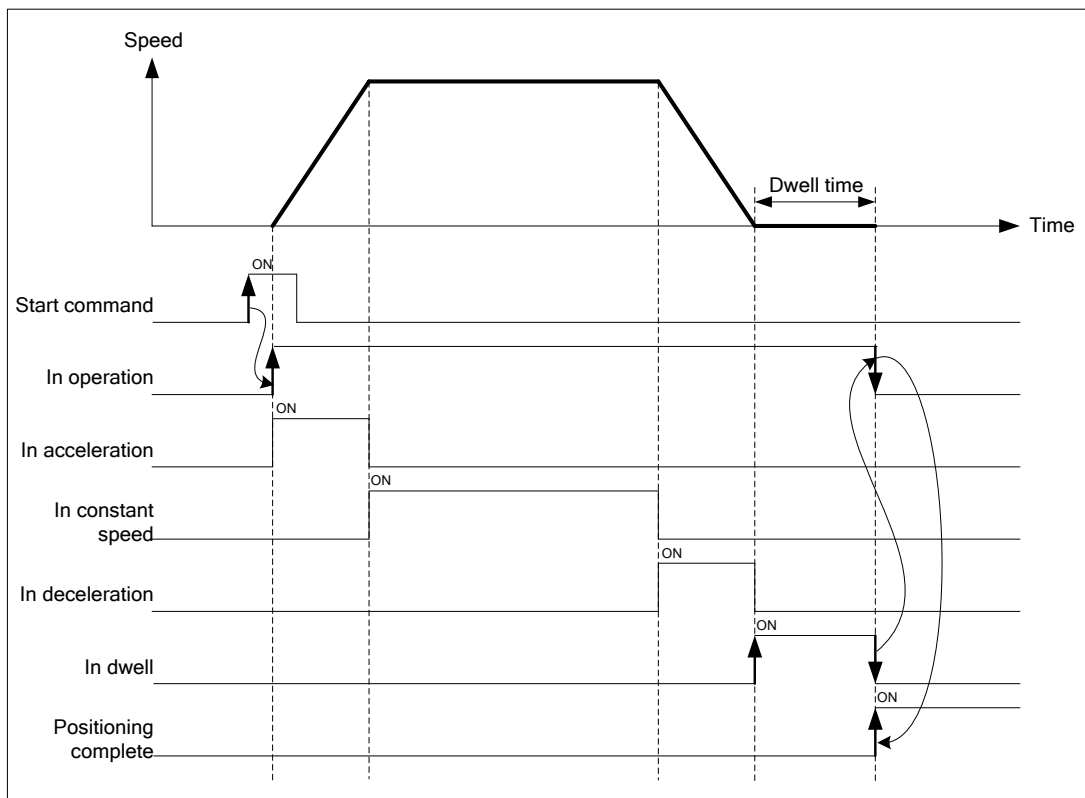
1) Normal Operation Patterns

Chapter 8 Functions

2) Abnormal Operation Patterns

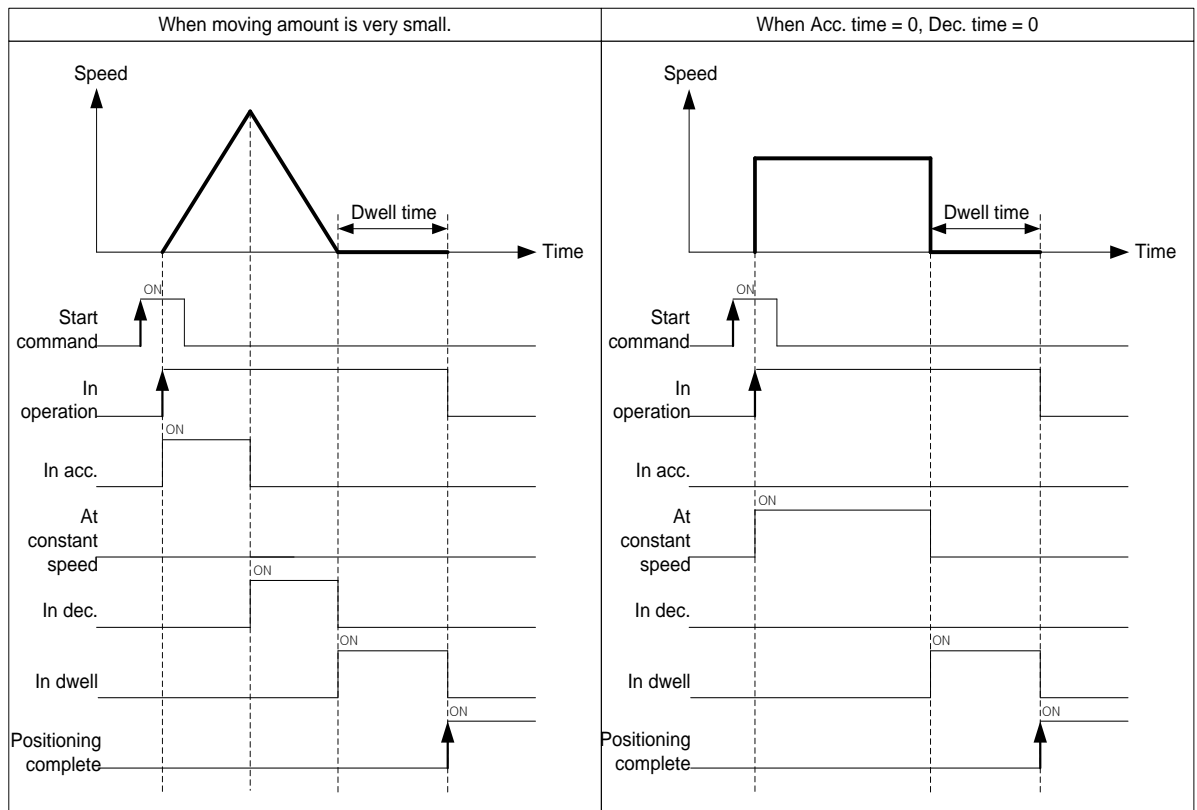

[Example]

- When indirect start command is executed[when Step No. of command is set to 0].
- Starting command execute total four times.

■ Setting of XG-PM

Step NO.	Control Method	Operation Method	Goal Position [pls]	Operation Speed [pls/s]	Accel NO.	Decel NO.	M Code	Dwell Time
1	Absolute Single-axis Positioning Control	Single,End	10000	1000	1	1	0	0
2	Absolute Single-axis Positioning Control	Single,End	15000	500	1	1	0	0
3	Absolute Single-axis Positioning Control	Single,End	25000	1000	1	1	0	0
4	Absolute Single-axis Positioning Control	Single,End	30000	500	1	1	0	0

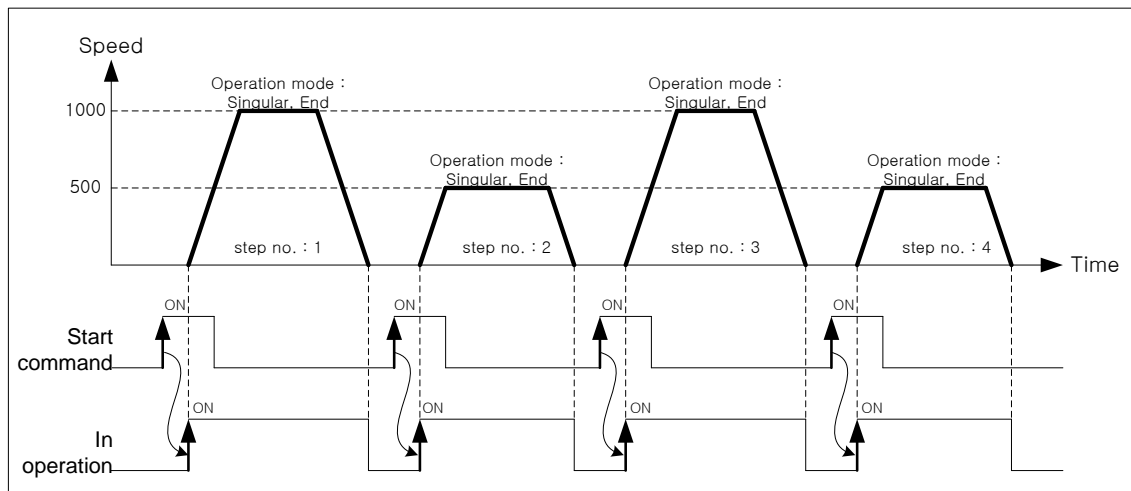
■ Operation Pattern

The operating step for each starting command will be [1] → [2] → [3] → [4].

Chapter 8 Functions

(2) End Operation (Repeat)

- With one time start command, the positioning to the goal position is executed and the positioning shall be completed at the same time as the dwell time proceeds.
- The operation pattern of Repeat operation mode is same as that of Single operation but the different thing is to determine next operation by operation step no. assigned by repeat step no. change command after positioning completion of Repeat operation mode.
- Therefore, if Repeat step no. change command was not executed, the step no. "1" shall be assigned after positioning completion of Repeat operation mode and operated at next Start command. Thus, this operation can be used for the structure that several operation steps are repeated.
- In case that operation step is set as the value except "0" (1~400) for Indirect Start, the positioning operation shall be done with the setting step no. regardless of the current operation step no. But, if the step no. is set as "0", the positioning operation shall be done with the current step no. changed by Repeat operation mode.
- Operation direction shall be determined by position address.
- Repeat operation step no. change command is available to execute during operation.

[Example 1]

- When indirect start command is executed [when Step No. of command is set to 0].
- Starting command execute total four times.

■ Setting of XG-PM

Step NO.	Control Method	Operation Method	Goal Position [pls]	Operation Speed [pls/s]	Accel NO.	Decel NO.	M Code	Dwell Time
1	Absolute Single-axis Positioning Control	Single,End	10000	1000	1	1	0	0
2	Absolute Single-axis Positioning Control	Repeat,End	15000	500	1	1	0	0
3	Absolute Single-axis Positioning Control	Single,End	25000	1000	1	1	0	0
4	Absolute Single-axis Positioning Control	Repeat,End	30000	500	1	1	0	0

■ Operation Pattern

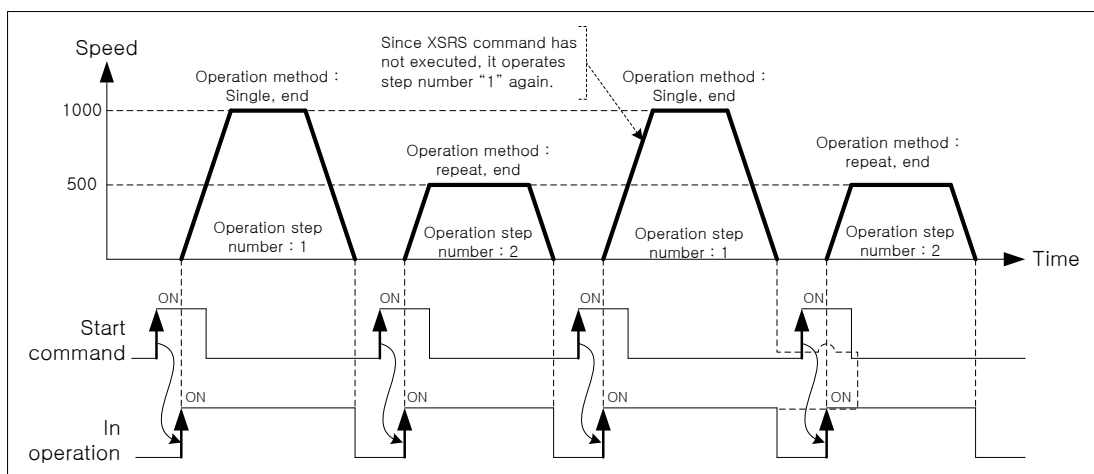

The operating step for each starting command will be [1] → [2] → [1] → [2].

The operating step3 and step4 will not be executed

[Example 2]

- When indirect start command is executed[when Step No. of command is set to 0].
- After the first starting command, change repeat operation step number as "3" by Change repeat step number command(XSRS).
- Execute starting command 3 times more.

■ Setting of XG-PM

Step NO.	Control Method	Operation Method	Goal Position [pls]	Operation Speed [pls/s]	Accel NO.	Decel NO.	M Code	Dwell Time
1	Absolute Single-axis Positioning Control	Single,End	10000	1000	1	1	0	0
2	Absolute Single-axis Positioning Control	Repeat,End	15000	500	1	1	0	0
3	Absolute Single-axis Positioning Control	Single,End	25000	1000	1	1	0	0
4	Absolute Single-axis Positioning Control	Repeat,End	30000	500	1	1	0	0

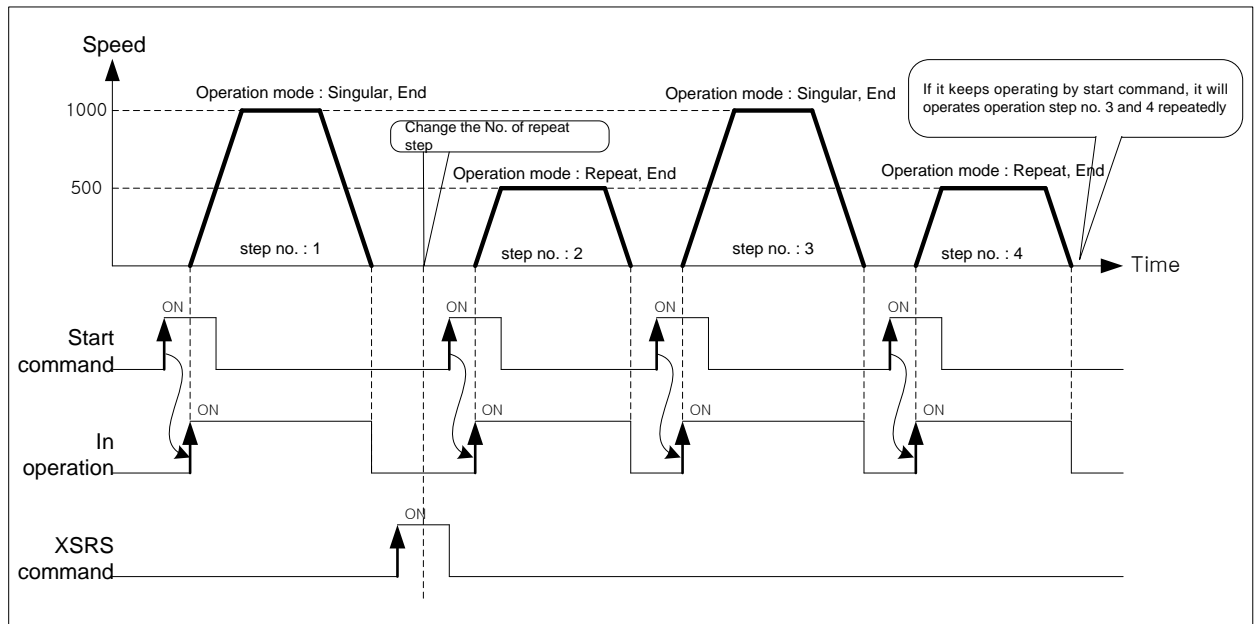
■ Operation Pattern

The operating step for each starting command will be [1] → [2] → [3] → [4].

Chapter 8 Functions

(3) Keep Operation

- With one time Start command, the positioning to the goal position of operation step is executed and the positioning shall be completed at the same time as dwell time proceeds and without additional start command, the positioning of operation step for (current operation step no. +1) shall be done.
- Keep operation mode is available to execute several operation steps in order.
- Set the operation pattern by 'End' when executing the last step of Keep operation.
- When operation pattern is Keep, continue operation until operation pattern come out as 'End'. If there is no "END" operation pattern, execute until operation step No. 400. and if operation pattern of step 400 is not "End", error occurs and operation will be stop. When operation pattern of step 400 is 'Repeat,Keep", execute operation data of Repeat Step Number.
- Operation direction shall be determined by setting value of goal position.

[Example]

- When indirect start command is executed[when Step No. of command is set to 0].
- Starting command execute total two times.

■ Setting of XG-PM

Step NO.	Control Method	Operation Method	Goal Position [pls]	Operation Speed [pls/s]	Accel NO.	Decel NO.	M Code	Dwell Time
1	Absolute Single-axis Positioning Control	Single,Keep	10000	1000	1	1	0	0
2	Absolute Single-axis Positioning Control	Single,Keep	15000	500	1	1	0	0
3	Absolute Single-axis Positioning Control	Single,End	25000	1000	1	1	0	0
4	Absolute Single-axis Positioning Control	Single,End	30000	500	1	1	0	0

■ Operation Pattern

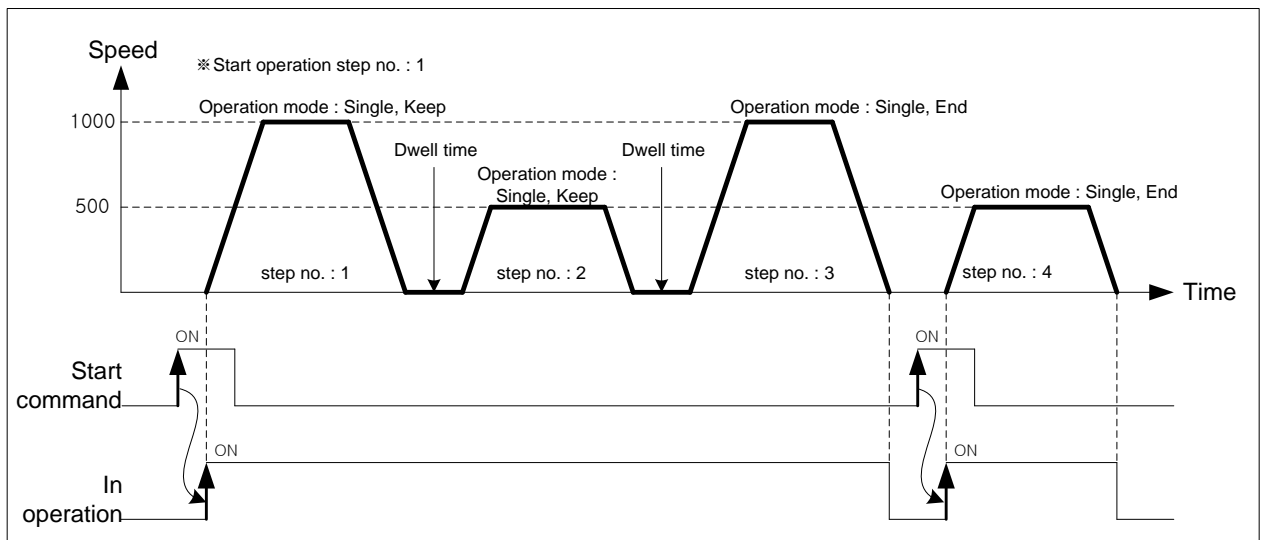

The operating step for each starting command will be [1 → 2 → 3] → [4].

(4) Continuous Operation

(a) Continuous Operation Overview

- 1) With one time Start command, the positioning for operation step set by continuous operation mode is executed to the goal position without stop and the positioning shall be completed at the same time as dwell time proceeds.
- 2) if the moving amount of next operation step is smaller than the deceleration distance from current position, the "Look ahead control" is activated to avoid immediate stop at [operation speed \neq bias speed].
- 3) Steps of dwell time set as 'Continuous' operation mode is ignored, steps of dwell time set as 'End' operation pattern is valid.
- 4) When you execute 'Continuous' operation mode, always set as 'End' for the very last operation step.
- 5) When operation pattern is continuous, continue operation until operation pattern come out as 'End'. If there is no "END" operation pattern, execute until operation step No. 400. and if operation pattern of step 400 is not "End", error occurs and operation will be stop. When operation pattern of step 400 is 'Repeat, continuous", execute operation data of Repeat Step Number.
- 6) Operation direction shall be determined by setting value of goal position.
- 7) If you want to operate with the position and speed of next step before the current operation step reaches the goal position, the operation by the Next Move continuous operation」(XNMV) command is available.
- 8) 「Next Move continuous operation」(XNMV) command can be executes in the acceleration, constant speed, deceleration section of Continuous operation.
- 9) when executing continuous operation, The continuous operation item of common parameter must be set to "Enable". Control period will be 5ms if continuous operation is enabled and it will be 1ms if continuous operation is disabled. therefore it is recommended to disable this parameter if continuous operation is not required.

[Example]

- When indirect start command is executed[when Step No. of command is set to 0].
- Starting command execute one time.

■ Setting of XG-PM

Step NO.	Control Method	Operation Method	Goal Position [pls]	Operation Speed [pls/s]	Accel NO.	Decel NO.	M Code	Dwell Time
1	Absolute Single-axis Positioning Control	Single,Cont	10000	1000	1	1	0	0
2	Absolute Single-axis Positioning Control	Single,Cont	30000	500	1	1	0	0
3	Absolute Single-axis Positioning Control	Single,End	40000	300	1	1	0	0

■ Operation Pattern

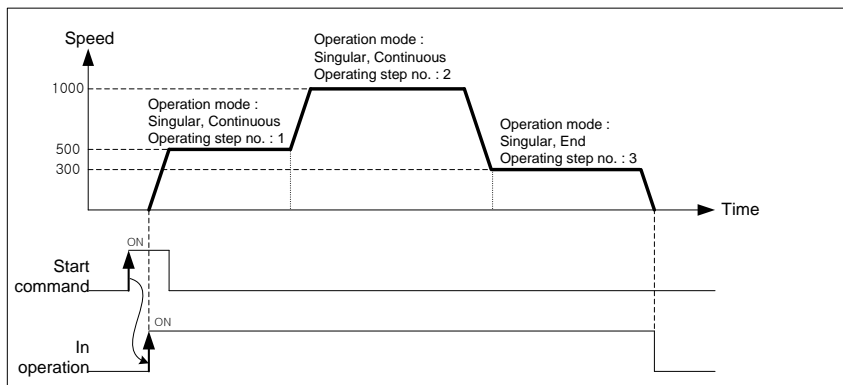

Operating step that execute according to starting command order will be [1 → 2 → 3].

Note

1. When operation method is continuous, sometimes it can be changed to next operation step speed before reaching the amount of movement current step's goal position. This is operation to change operating speed continuously, The remained moving amount of current step is operated in next step.
(The remaining distance is less than the distance can be moved within 1 control cycle at current speed)
2. If the control method is set as linear or circular interpolation and the operation method is set as continuous, operating speed of positioning will be different according to the interpolation continuous operation positioning method」 of extended parameter.
refer to continuous operation of interpolation control for detail.

(b) Look Ahead

- 1) if the moving amount of next operation step is smaller than the deceleration distance from current position, the "Look ahead control" is activated to avoid immediate stop at [operation speed \neq bias speed].
- 2) The "Look Ahead control" is control method which calculate the available entry speed for next step by goal position of current and next step and change current speed. if the moving amount of next operation step is smaller than the deceleration distance from current position, it will decrease the current speed to make stop speed and bias speed equal..
- 3) XEC-DN32UP embedded positioning executes the "Look Ahead" using goal position of total 3 steps including current step..

The difference of general continuous operation and Look Ahead control is as below.

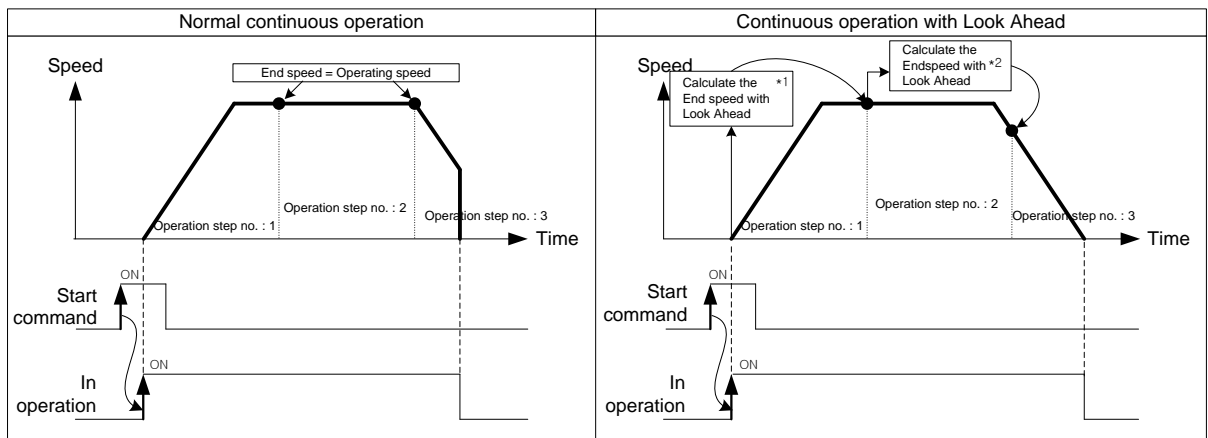

*1 : moving amount of Step 2 and Step 3 is more than the deceleration stop distance from operation speed. So, endpoint speed = operation speed.

*2 : When moving amount of step 3 is smaller than deceleration stop distance from operation speed of step 2. Therefore, it calculate available end point speed for step 2 by goal position of step2,3 and change speed to this..

(c) Continuous operation of interpolation control

When control method is linear or circular interpolation and operation method is Continuous, positioning operation is different according to the setting value by extended parameter of 「Continuous interpolation positioning method」. There are two methods of interpolation.

One is 「Passing Goal Position」 which passes through the specified goal position and the other is 「Near Passing」 which proceed to the next step at near position not to exceed a specified goal position.

「continuous interpolation positioning method」 setting of expanded parameter is as below.

Item	Setting Value	Contents
Continuous interpolation positioning method	0 : Passing Goal Position	Execute Continuous Operation which passes exact goal position of current step which set on operation data.
	1 : Near Passing	Execute Continuous operation which passes near position not to exceed a current step's goal position..

1) Passing Goal Position Continuous Operation

「Passing Goal Position」 Continuous Operation must be passing by goal position to the data set on goal position when changing from current step to next step. In the interpolation control, when execute a continuous operation from current step to next step, there can be mechanical vibration caused by discontinuous operating speed because of remaining moving amount.

XEC-DN32UP use the speed compensation. It can solve mechanical vibration problem and execute Continuous operation which user set by from goal position to next step.

Next, describing the principle of 「passing goal position」 Continuous operation

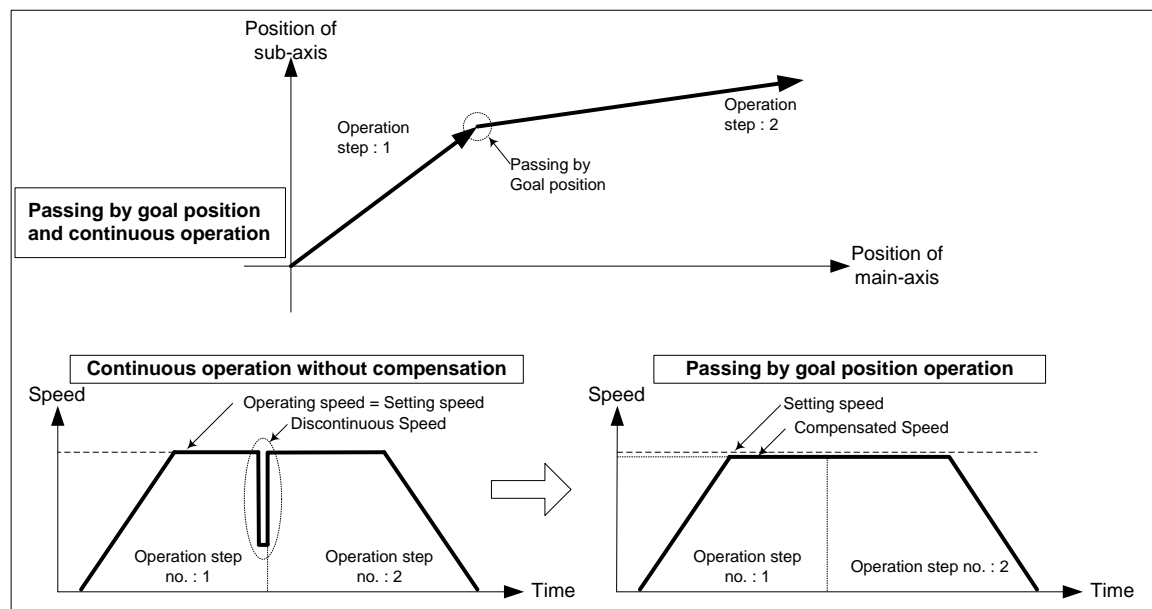

It decrease speed of acceleration, constant speed section as much as remaining amount of movement at the last section of current step to compensate position if operates as passing goal position operation.

Because next step can start with compensated speed, can avoid occurrence of discontinuous operating speed.

Chapter 8 Functions

2) Near Passing Continuous Operation

It changes to the next step at near position not exceeding goal position of current step.

This is the way to eliminate discontinuous operating speed which occurs by remaining amount of movement data at the last of current step.

Next, describing the principle of 「Near Passing」 Continuous operation.

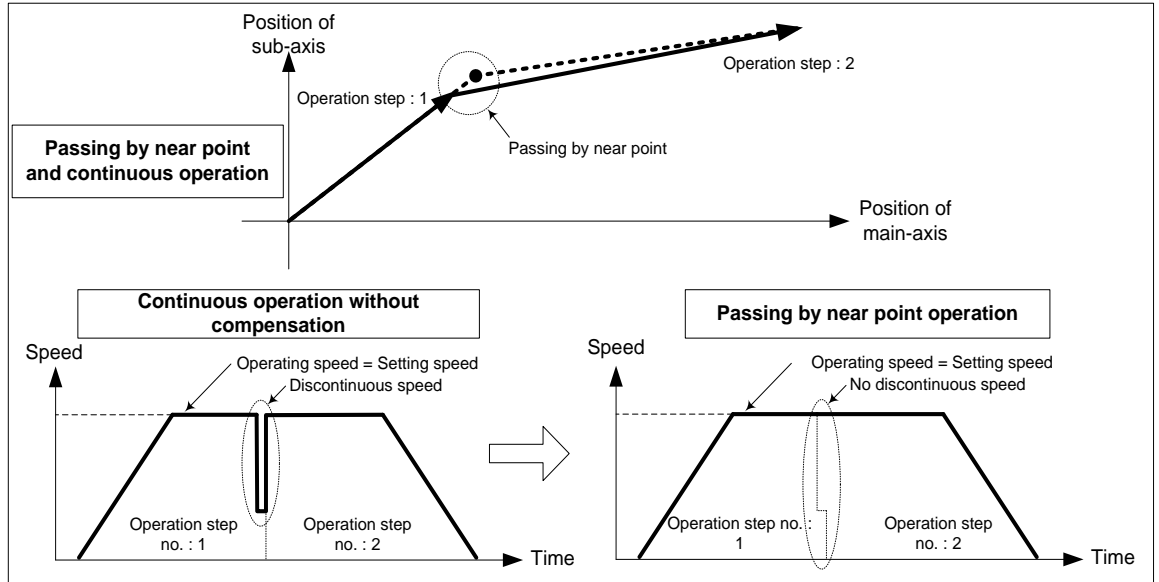

In the picture above, during general Continuous Operation, Occurring speed discontinuity because of remaining amount of movement at the last operation step NO.1. 「Near Passing」 Continuous Operation, you can move the remaining amount of movement to next step and execute Continuous Operation without speed discontinuity.

Note

When using 「Near passing」 continuous operation, sometimes it operates with next step speed before reaching the amount of movement set on goal position to remove the discontinuity of speed.

However in the case of Interpolation Continuous Operation control, it can have a gap with trajectory data which user set if it operates speed of the next step before reaching the goal position.

The following is the maximum difference of position for each axis.

- Difference of maximum axis position $< (\text{speed of each axis (pls / s)} \times \text{control cycle (= 1ms or 5ms)})$

(d) Deceleration Stop of Continuous Operation

Continuous operation control is decelerating and positioning completed during the 'End' operation step. However, next time, it keeps next step operation after decelerating as bias speed

- 1) When the moving direction of current executing operation step and the moving direction of next step is different (the case of single positioning control only)

■ Setting of XG-PM

Step NO.	Control Method	Operation Method	Goal Position [pls]	Operation Speed[pls/s]	Accel NO.	Decel NO.	M Code	Dwell Time
1	Absolute Single-axis Positioning Control	Single Continuous	10000	1000	1	1	0	0
2	Absolute Single-axis Positioning Control	Single End	3000	700	1	1	0	0

■ Operation Pattern

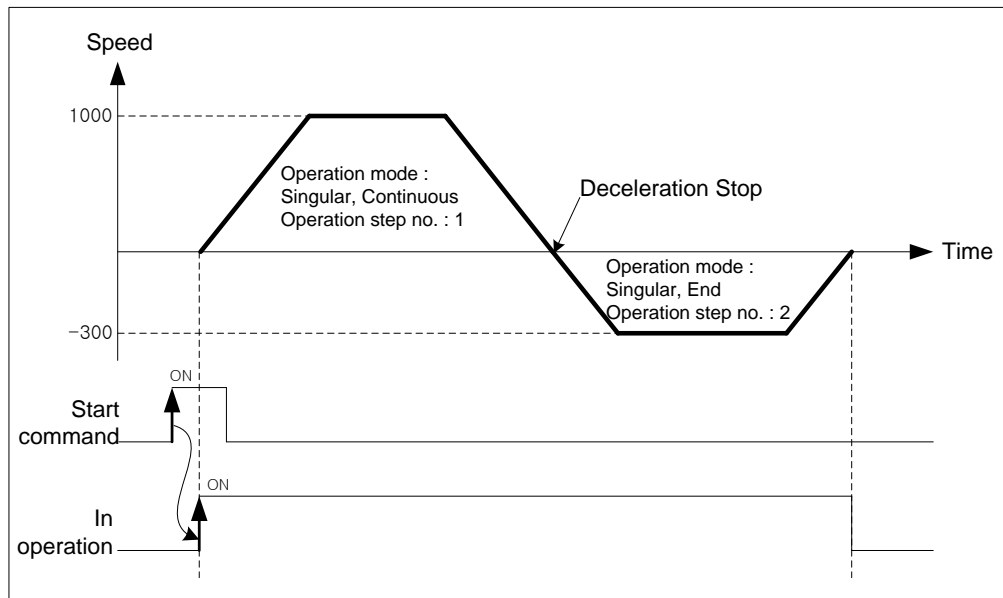

The Step1 will be operated by the start command. however, because the goal position of next step is on opposite direction from the goal position of step1, it stops after deceleration, and then operate Step2 to a opposite direction.

- 2) When the moving amount of next step is 0

When the next step's moving amount is 0, operation speed will be 0 during one control period.

■ Setting of XG-PM

Step NO.	Control Method	Operation Method	Goal Position [pls]	Operation Speed [pls/s]	Accel NO.	Decel NO.	M Code	Dwell Time
1	Absolute Single-axis Positioning Control	Single Continuous	10000	1000	1	1	0	0
2	Absolute Single-axis Positioning Control	Single Continuous	10000	700	1	1	0	0
3	Absolute Single-axis Positioning Control	Single End	15000	500	1	1	0	0

Chapter 8 Functions

■ Operation Pattern

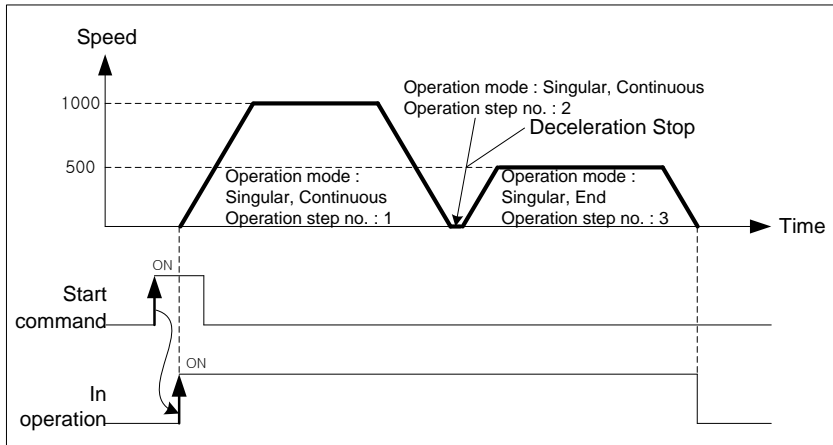

The Step1 will be operated by the start command. However, because the moving amount of next step is 0, it stops after deceleration, and then operates Step3 after 1 control period.

3) If there is an error on the operation data of next step

If there is an error on the next step's data (for example, if the operation speed of next step is 0 or if the operation method of current step is 「Single-axis Positioning Control」 but operation method of Next step is 「Single-axis FEED Control」), it stops after deceleration after current step's operation, and then completes operation.

■ Setting of XG-PM

Step NO.	Control Method	Operation Method	Goal Position [pls]	Operation Speed [pls/s]	Accel NO.	Decel NO.	M Code	Dwell Time
1	Absolute Single-axis Positioning Control	Single Continuous	10000	1000	1	1	0	0
2	Absolute Single-axis Feed Control	Single Continuous	20000	1000	1	1	0	0
3	Absolute Single-axis Positioning Control	Single End	30000	1000	1	1	0	0

■ Operation Pattern

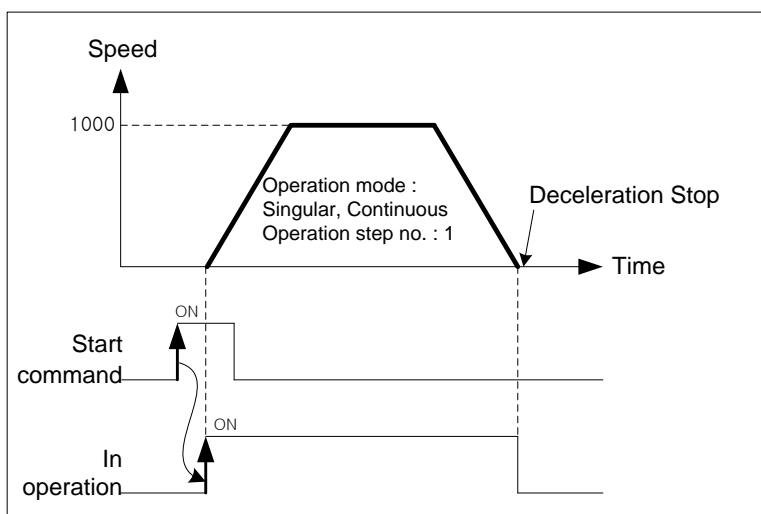

Note

During Continuous Operation of Linear interpolation or circular interpolation, because the PLC does not check the direction of movement, does not deceleration stop even if the moving direction is changed.

Therefore, if there is opposite direction of goal position set on operation data, it may cause damages to machine because of rapid direction changing.

In this case, use the operation method of 「Keep」 to prevent the damage for system.

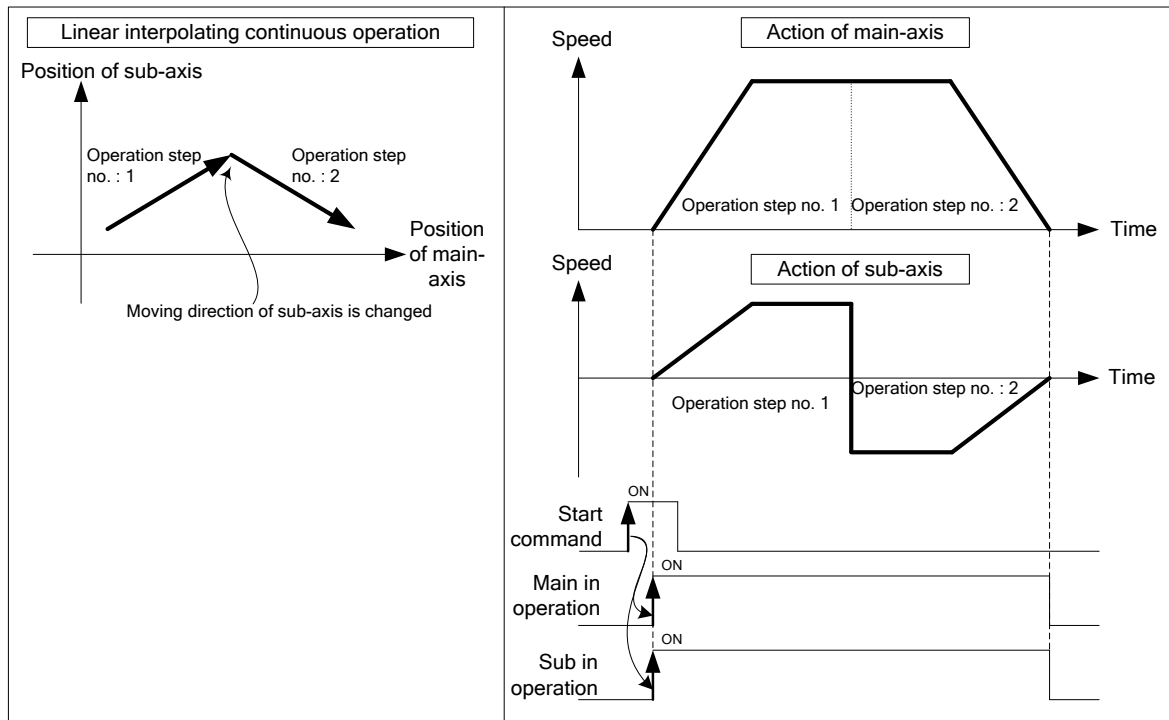

Chapter 8 Functions

8.2.3 Single-axis Positioning Control

After executed by the start positioning operation command (「Direct start」 , 「Indirect start」 , 「Simultaneous start」), positioning control from specified axis (the current stop position) to goal position (the position to move).

(1) Control by Absolute method (Absolute coordinate) (「Absolute, Single-axis Positioning Control」)

- (a) Positioning control from start position to goal position (the position assigned by positioning data). Positioning control is carried out based on the position assigned (origin position) by homing.
- (b) Moving direction shall be determined by start position and goal position.
 - ▶ Start position < Goal position: forward direction positioning
 - ▶ Start position > Goal position: reverse direction positioning

[Example] Set the Absolute Coordinates as follow, Operate single-axis positioning control.

- ▷ Start position: 1000,
- ▷ Goal position: 8000

The transfer amount to forward direction shall be 7000 ($7000=8000-1000$).

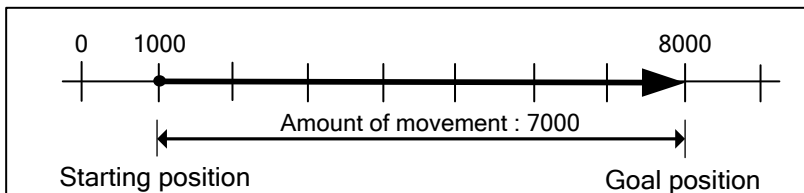

■ Setting of XG-PM

Step NO.	Control Method	Operation Method	Goal Position [pls]	Operation Speed [pls/s]	Accel NO.	Decel NO.	M Code	Dwell Time
1	Absolute Single-axis Positioning Control	Single End	8000	1000	1	1	0	100

■ Operation Pattern

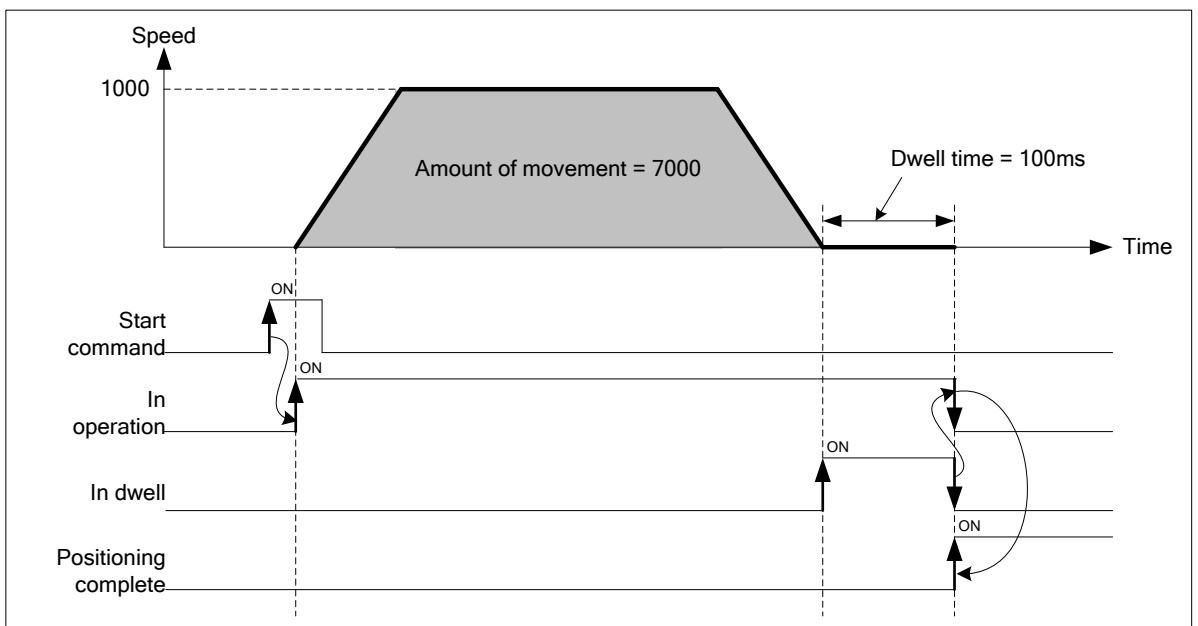

(2) Control by Incremental method (Relative coordinate) (「Relative, Single-axis Positioning Control」)

- (a) Positioning control as much as the goal transfer amount from start position. Unlike the absolute coordinates of goal position, it is not a value of specified on goal position; it is a moving amount of current position.
- (b) Transfer direction shall be determined by the sign of transfer amount.
- ▷ Transfer direction (+) or no sign: forward direction (current position increase) positioning
 - ▷ Transfer direction (-) : reverse direction (current position decrease) positioning

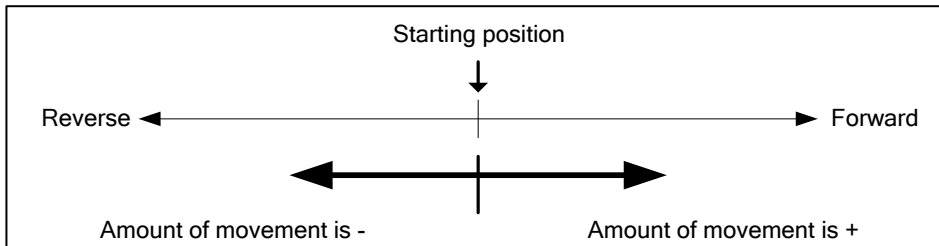

[Example] Set the Relative Coordinates as follow, Operate single-axis positioning control.

- ▷ Start position: 5000,
- ▷ Goal position: -7000

This will be reverse direction and positioning will be at the point of -2000.

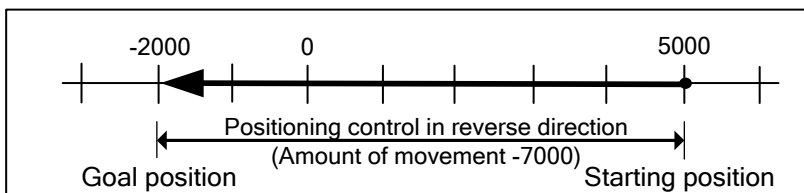

■ Setting of XG-PM

Step NO.	Control Method	Operation Method	Goal Position [pls]	Operation Speed [pls/s]	Accel NO.	Decel NO.	M Code	Dwell Time
1	Incremental Single-axis Positioning Control	Single End	-7000	1000	1	1	0	100

■ Operation Pattern

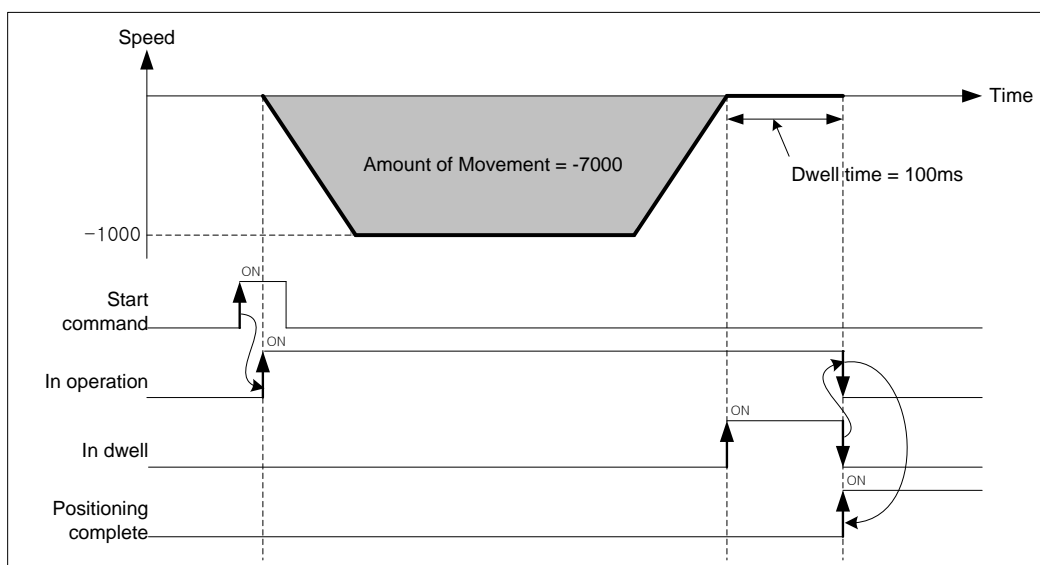

Chapter 8 Functions

8.2.4 Single-axis Speed Control

After executed by the start positioning operation command (「Direct start」 , 「Indirect start」 , 「Simultaneous start」), this controls the speed by the setting speed until deceleration stop command is entered.

(1) Features of Control

- (a) Speed control contains 2 types of start : Forward direction start and Reverse direction start.
 - ▷ Forward direction : when position value is positive number (+) ("0" included)
 - ▷ Reverse direction : when position value is negative number (-)
- (b) In case of using speed control, the following items of operation data do not affect.
 - ▷ Coordinates, Operation method, Dwell time
 - ▷ "Absolute, single-axis speed control", "Relative, single-axis speed control" execute same operation.
- (c) Accelerating operation of speed control operate with acceleration number and time on setting data, decelerating operation operate with deceleration number and time of a command 「deceleration stop」

(2) Operation Timing

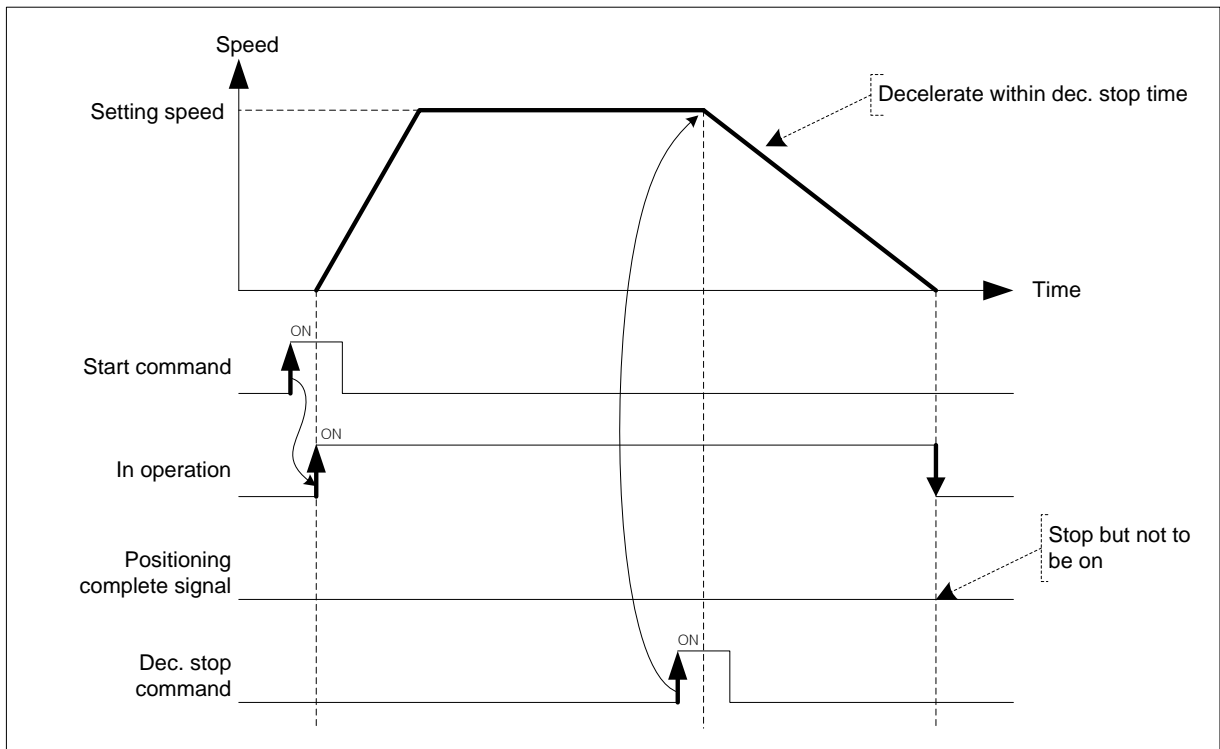

(3) Restrictions

- (a) Set the operation pattern of speed control as 'End' or 'Keep'. When it is set on "Continuous", error occurs (error code: 236) and can not execute speed control.
- (b) Using as speed control, only when 「M code mode」 of extended parameter is "with" , M code signal is "On". (When "After mode", M code signal is not "On".)

(c) Speed control of software upper/lower limit checking change according to the setting of the speed control of software upper/lower limit check.

Item	Setting Value	Contents
During Speed Control S/W Upper/Lower limit	0 : Not Detect	During Speed Control, do not operate to check the range of upper/lower limit of software
	1 : Detect	During Speed Control, operate to check the range of upper/lower limit of software

(4) Setting of XG-PM

Step NO.	Control Method	Operation Method	Goal Position [pls]	Operation Speed [pls/s]	Accel NO.	Decel NO.	M Code	Dwell Time
1	Absolute Single-axis Speed Control	Single End	100	1000	1	1	0	0

Chapter 8 Functions

8.2.5 Single-axis Feed Control

After executed by the start positioning operation command (「Direct start」, 「Indirect start」, 「Simultaneous start」), change current stop position as '0', positioning control until setting goal position.

(1) Features of control

- (a) The value set on goal position is moving amount. That is, moving direction is decided by the code of setting goal position.
 - ▷ Forward direction : when position address is positive number (+) ("0" included)
 - ▷ Reverse direction : when position address is negative number (-)
- (b) In case of using Single-axis Feed Control, the following items of operation data do not affect.
 - ▷ Coordinates
 - ▷ "Absolute, single-axis speed control", "Relative, single-axis speed control" execute same operation.

(2) Operation Timing

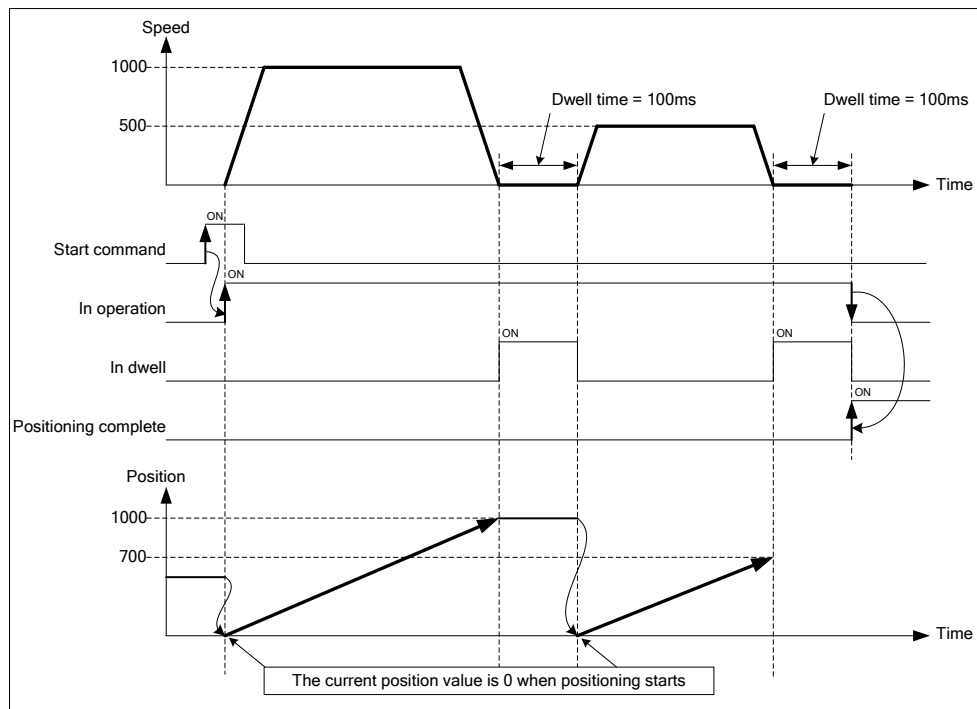

(3) Restrictions

- (a) Set the operation pattern of Feed control as 'End' or 'Keep'. When it is set on "Continuous", error occurs (error code: 230) and can not execute Feed control.

(4) Setting of XG-PM

Step NO.	Control Method	Operation Method	Goal Position [pls]	Operation Speed [pls/s]	Accel NO.	Decel NO.	M Code	Dwell Time
1	Absolute Single-axis Feed Control	Single Keep	1000	1000	1	1	0	100
2	Absolute Single-axis Feed Control	Single End	700	500	1	1	0	100

8.2.6 Linear Interpolation Control with 2 axes

After executed by positioning operation start command (「Indirect start」, 「Synchronous start」), then executing interpolation control from starting position to the goal position with interpolation axis set as the main axis and sub axis.

(1) Linear interpolation control with absolute coordinates (「Absolute, Linear Interpolation」)

- (a) Execute linear interpolation from starting position to the goal position designated on positioning data. Positioning control is on basis of the designated position from homing.
- (b) The direction of movement depends on the starting position and the goal position for each axis.
 - Starting position < Goal position : Positioning operation in forward
 - Starting position > Goal position : Positioning operation in reverse

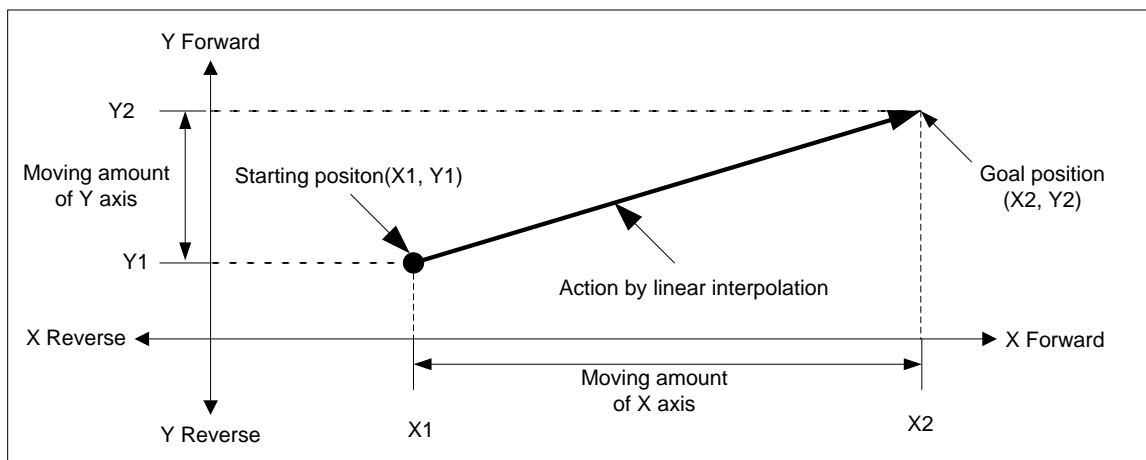

(c) Restrictions

Linear interpolation with 2 axes may not be executed in the case below.

- 「Sub axis setting」 Error (error code : 253)
 - 「Sub axis setting」 of main axis operating data is "Axis-undecided"
 - 「Sub axis setting」 of main axis operating data is the same as main axis no.
 - 「Sub axis setting」 of main axis operating data exceeds the settable axis No.

Note

Because more than 2 axes are in action, so need user to pay attention

- (1) The commands available are as follows.
Speed override, Dec. time, Emergent stop, Skip operation, Continuous operation
- (2) The commands unavailable in linear interpolation are as follows.
Position/Speed switching control, Position override
- (3) The parameter items which work depending on the value of each axis are as follows.
Backlash compensation, Software Upper/Lower limit

Chapter 8 Functions

(d) Setting example of operating data

Items	Main-axis setting	Sub-axis setting	Description
Control method	Absolute, Linear interpolation	- *1	When linear interpolation control is executed by the method of absolute coordinates, set 「Absolute, Linear interpolation」 on the main axis
Operating method	Singular, End	-	Set the operating method to execute linear interpolation
Goal position [pls]	10000	5000	Set the goal position to position on main-axis and sub-axis
Operating speed [pls/s]	1000	-	Use speed-designated method of main axis for linear interpolation
Acc. no.	No.1	-	Set acc. no. for acceleration (no.1 ~ no.4)
Dec. no.	No.2	-	Set dec. no. for deceleration (no.1 ~ no.4)
M code	0	-	When need to execute auxiliary work synchronizing with linear interpolation
Dwell time	500	-	Set dwell time(ms) to outputting the signal positioning completion
Sub-axis setting	Axis2	-	Set an axis to be used as sub-axis among settable axis in operating data of main-axis

*1 : It does not need to be set. Whatever value is set as, it does not affect linear interpolation.

Note

Linear interpolation control is executed on the basis of operating data of main axis.

Only 「Goal position」 item of sub-axis setting affect linear interpolation. In other word, whatever value is set as, it does not affect the operation and errors do not arise.

[Example] axis1 and axis2 are main and sub axis each. Execute linear interpolation by the setting as follows

■ Starting position (1000, 4000), Goal position (10000, 1000) : In this condition, the operation is as follows.

■ Setting example of XG-PM

▪ Operating data of main-axis(axis1)

Step NO.	Control Method	Operation Method	Goal Position [pls]	Operation Speed [pls/s]	Accel NO.	Decel NO.	M Code	Dwell Time	Sub axis setting
1	Absolute, Linear	Singular, End	10000	3000	1	1	0	100	Axis 2

▪ Operating data of sub-axis(axis2)

Step NO.	Control Method	Operation Method	Goal Position [pls]	Operation Speed [pls/s]	Accel NO.	Decel NO.	M Code	Dwell Time	Sub axis setting
1	Absolute, Single positioning control	Singular, End	1000	0	1	1	0	0	Axis-undecided

■ Operating pattern

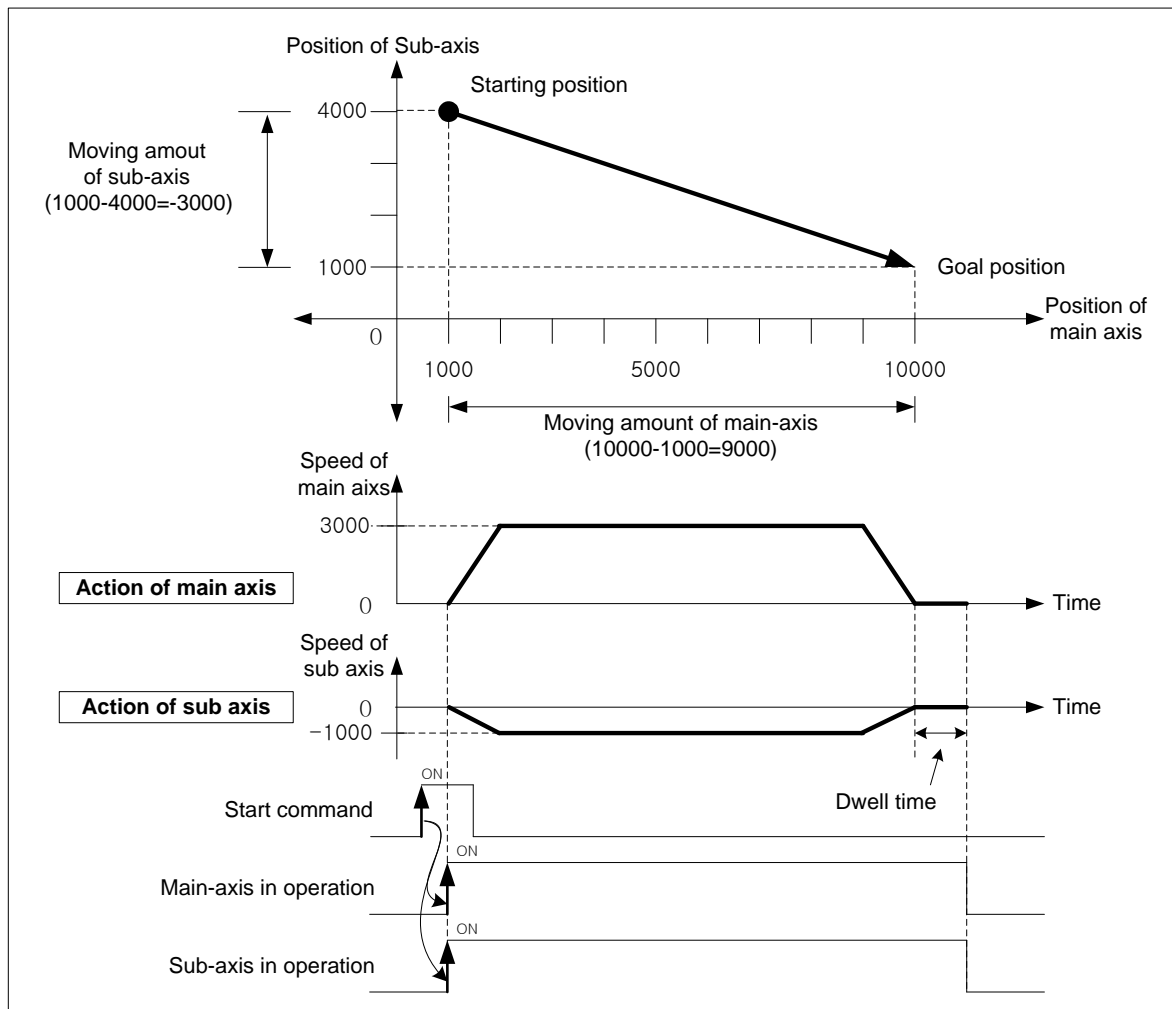

Chapter 8 Functions

(2) Linear interpolation control with relative coordinates (「Relative, Linear Interpolation」)

- (a) Execute 2 axes linear interpolation from starting position to the goal position. Positioning control is on basis of the current stop position.
- (b) Moving direction depends on the sign of the goal position (Moving amount)
 - The sign is positive (+ or nothing) : Positioning operation in forward
 - The sign is negative (-) : Positioning operation in reverse

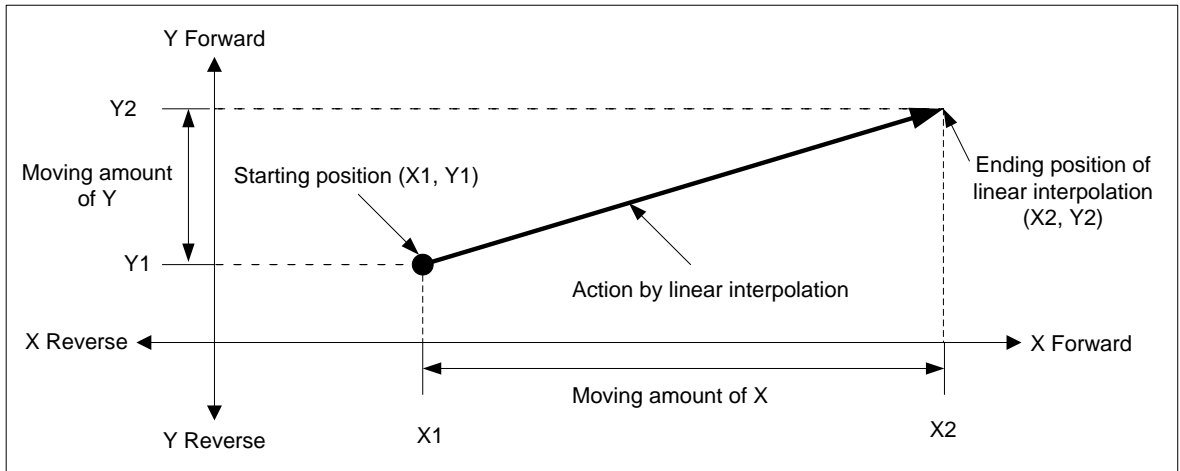

(c) Restrictions

Linear interpolation with 2 axes may not be executed in the case below.

- 「Sub-axis setting」 error (error code : 253)
 - 「Sub-axis setting」 value of main axis operating data is "Axis-undecided"
 - 「Sub-axis setting」 value of main axis operating data is same as the main axis no.
 - 「Sub-axis setting」 value of main axis operating data exceeds settable axis no.

(d) Setting example of operation data

Items	Main-axis setting	Sub-axis setting	Description
Control method	Relative, Linear interpolation	- *1	When linear interpolation control is executed by the method of relative coordinates, set 「Relative, Linear interpolation」 on the main axis
Operating method	Singular, End	-	Set the operating method to execute linear interpolation
Goal position[pls]	10000	5000	Set the goal position to position on main & sub-axis
Operating speed [pls/s]	1000	-	Use speed-designated method of main axis for linear interpolation
Acc. no.	No.1	-	Set acc. no. for acceleration (no.1 ~ no.4)
Dec. no.	No.2	-	Set dec. no. for deceleration (no.1 ~ no.4)
M code	0	-	When need to execute auxiliary work synchronizing with linear interpolation
Dwell time	500	-	Set dwell time(ms) to outputting the signal positioning completion
Sub-axis setting	Axis2	-	Set an axis to be used as sub-axis among settable axis in operating data of main-axis

*1 : It does not need to be set. Whatever value is set as, it does not affect linear interpolation.

Note

In linear interpolation start, more than 2 axes operate synchronously. Need users to pay attention.

(1) Auxiliary operations may be used are as follows.

- Speed override, Dec. stop, Emergent stop, Skip operation, Continuous operation

(2) The commands may not be used in linear interpolation are as follows.

- Position/Speed switching control, Position override.

(3) The parameter items operating on the basis of setting value on each axis are as follows.

- Backlash correction in extended parameter, Software high/low limit, Software low limit

[Example] axis1 and axis2 are main and sub axis each. Execute linear interpolation by the setting as follows.

■ Starting position (1000, 4000), Goal position (9000, -3000) : In this condition, the operation is as follows.

■ Setting example of XG-PM

▪ Operating data of main-axis(axis1)

Step NO.	Control Method	Operation Method	Goal Position [pls]	Operation Speed [pls/s]	Accel NO.	Decel NO.	M Code	Dwell Time	Sub axis setting
1	Absolute, Linear	Singular, End	9000	3000	1	1	0	100	Axis2

▪ Operating data of sub-axis(axis2)

Step NO.	Control Method	Operation Method	Goal Position [pls]	Operation Speed [pls/s]	Accel NO.	Decel NO.	M Code	Dwell Time	Sub axis setting
1	Absolute, Single positioning control	Singular, End	-3000	0	1	1	0	0	None

■ Operating pattern

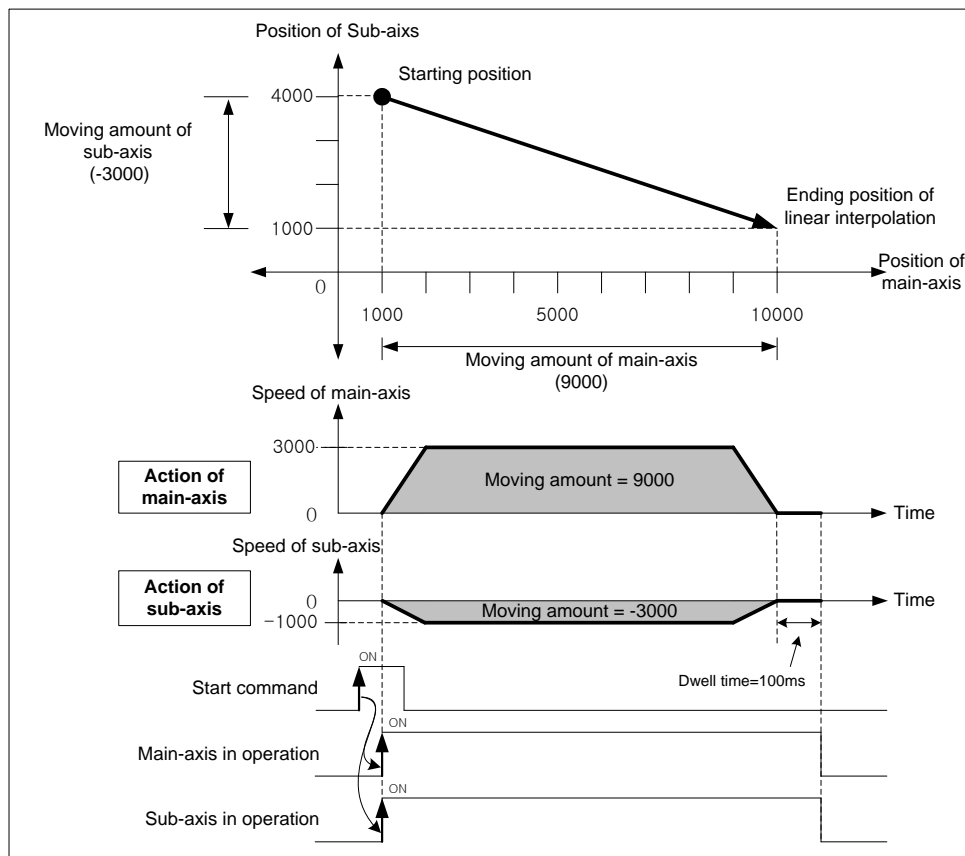

Chapter 8 Functions

(3) Speed in 2 axes linear interpolation control

Operating speed in linear interpolation is according to the method of main-axis designating. After operating speed is set on command axis (main), the designated axis for interpolation is operated by PLC's calculating each moving amount. Speed of sub-axis and actual speed of machine are calculated as follows.

■ Speed in 2 axes linear interpolation

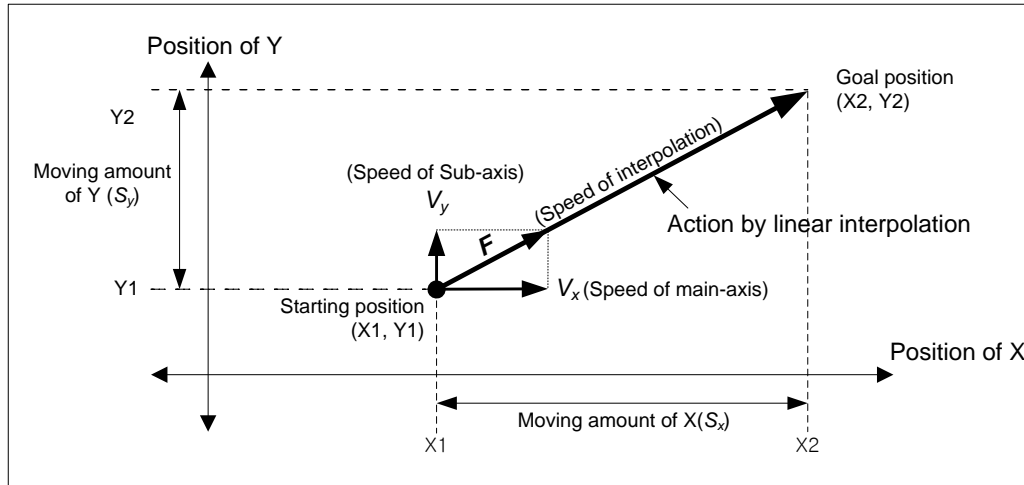

$$\text{Speed of sub}(V_y) = \text{Speed of main}(V_x) \times \frac{\text{Moving amount of Sub}(S_y)}{\text{Moving amount of Main}(S_x)}$$

$$\text{Interpolating speed}(F) = \sqrt{V_x^2 + V_y^2}$$

[Example]

- Starting position (2000, 1000)
- Goal position (6000, 4000)
- Operating speed : 400 [pls/s]

Speed of sub-axis and interpolating speed are as follows.

$$\text{Speed of sub-axis} = 400 \times \frac{3000}{4000} = 300 \text{ [pls/s]}$$

$$\text{Interpolating speed} = \sqrt{400^2 + 300^2} = 500 \text{ [pls/s]}$$

■ Speed in 2 axes linear interpolation (when Synthetic speed is selected)

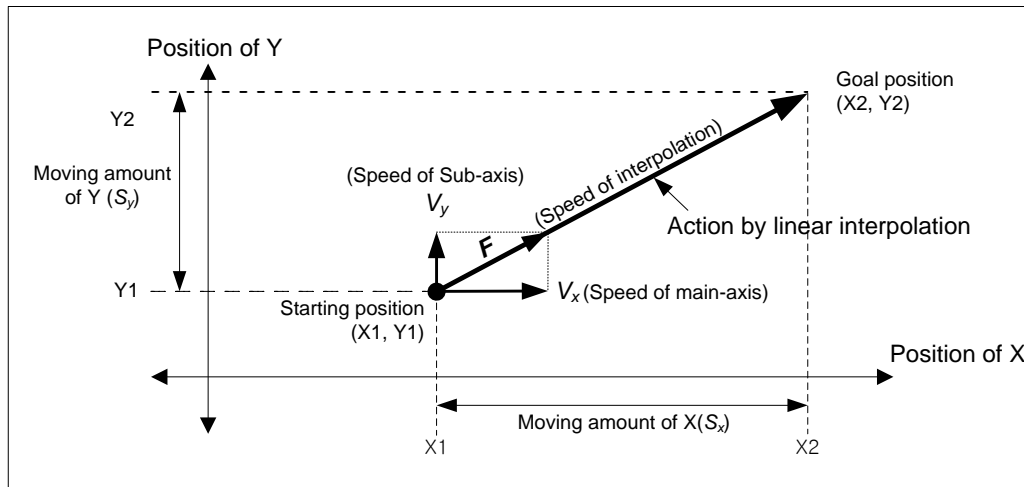

Interpolating speed(F) = Operating speed of main axis

$$\text{Interpolating moving amount(S)} = \sqrt{S_x^2 + S_y^2}$$

$$\text{Speed of main-axis} = \text{Interpolating speed(F)} \times \frac{\text{Main axis moving amount}(S_x)}{\text{Synthetic axis moving amount(S)}}$$

$$\text{Speed of sub-axis} = \text{Interpolating speed(F)} \times \frac{\text{Sub axis moving amount}(S_y)}{\text{Synthetic axis moving amount(S)}}$$

[Example]

- Starting position (2000, 1000)
- Goal position (6000, 4000)
- Synthetic speed : 400 [pls/s]

Speed of sub-axis and interpolating speed are as follows.

$$\text{Interpolating moving amount(S)} = \sqrt{4000^2 + 3000^2} = 5000$$

$$\text{Speed of main-axis} = 400 \times \frac{4000}{5000} = 320$$

$$\text{Speed of sub-axis} = 400 \times \frac{3000}{5000} = 240 \text{ [pls/s]}$$

Chapter 8 Functions

Note

(1) Speed limit for Sub-axis

When using linear interpolation control and moving distance of main < moving distance of sub, it is possible that sub-axis speed calculated by PLC exceeds 「Speed limit」 of basic parameter. In this case, error (error code : 261) arises and sub-axis speed is recalculated, then sub-axis continues to operate. To prevent that errors arise, operate it at the speed below limit.

(2) The speed when the distance main-axis moved is 0

When the distance main-axis moved is 0, the operating speed of main-axis operating data becomes actual interpolating speed. In the case that the distance main-axis moved is 0 and executing 2 axes linear interpolation, only sub-axis operates at the speed set on command axis.

■ Setting example of XG-PM

▪ Operating data of Main-axis

Step no.	Control method	Operating method	Goal position [pls]	Operating speed [pls/s]	Acc. no.	Dec. no.	M code	Dwell time	Sub axis setting
1	Absolute, Linear interpolation	Singular, Continuous	5000	1000	No.1	No.1	0	100	Axis2
2	Absolute, Linear interpolation	Singular, End	5000	1000	No.1	No.1	0	100	Axis2

▪ Operating data of Sub-axis

Step no.	Control method	Operating method	Goal position [pls]	Operating speed [pls/s]	Acc. no.	Dec. no.	M code	Dwell time	Sub axis setting
1	Absolute, single position control	Singular, End	1000	0	No.1	No.1	0	0	None
2	Absolute, single position control	Singular, End	3000	0	No.1	No.1 </td <td>0</td> <td>0</td> <td>None</td>	0	0	None

■ Operating pattern

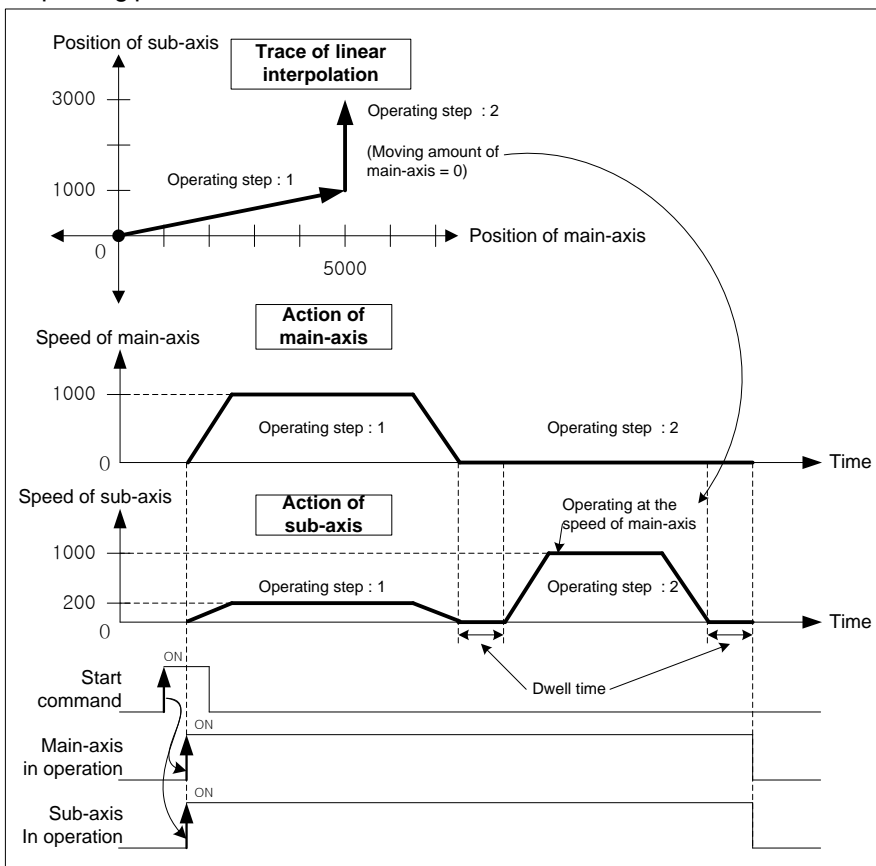

(4) 2 axes linear interpolating continuous operation with circular arc interpolation

When the operation method is set as “continuous” and the direction of movement changes rapidly, machine is possible to be damaged. When it does not have to position to the goal position, user may interpolate ‘circular interpolating operation’ between two trace to make operation softer and smoother.

(a) Operation order

- 1) Confirm the execution of 2 axes linear interpolating continuous operation with circular arc interpolation when linear interpolation starts. It may be set in 「2 axes linear interpolating continuous operation with circular arc interpolation」 of extended parameter.

Setting items	Setting value	Description
2 axes linear interpolating continuous operation with circular arc interpolation	0 : Not to execute	When executing it, not to interpolate circular arc
	1 : To execute	When executing it, interpolate circular arc

- 2) Reset the starting position of circular interpolation (Goal position of Linear trace 1) and the goal position (Starting position of Linear trace 2) through checking the position circular arc will be interpolated at. The position circular arc will be interpolation at may be set in 「Circular arc interpolating position」 of extended parameter.

Setting items	Setting value	Description
2 axes linear interpolating continuous operation with circular arc interpolation	0 ~ 2147483647	Set the position circular arc will be interpolated at. This value means the relative distance from the goal position of linear trace 1.

- 3) Execute linear interpolation to the starting position of circular arc and continue to execute circular interpolation at the same speed as linear interpolation. After finish the circular interpolation, continue to execute linear interpolation at the same speed.

(b) Operating pattern

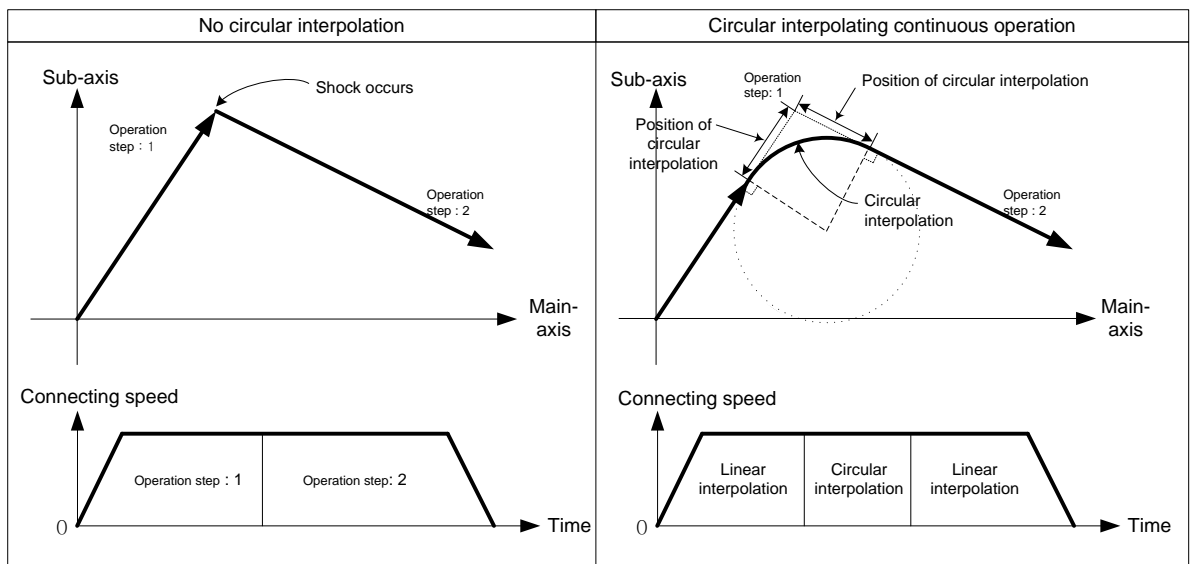

Chapter 8 Functions

(c) Restrictions

Circular interpolation is not executed in the case below but linear interpolation is executed to the goal position.

- Operating method of operation data is "End" or "Continue"
- Position of circular arc interpolating is bigger than linear trace 1, 2 (Error code : 262)
- Trace of both linear interpolations are on the same line

[Example] Execute linear interpolation when the extended parameter setting is same as follows at the current position (0,0)

Extended parameter	Setting value
2 axes linear interpolating continuous operation with circular arc interpolation	1 : Circular arc interpolating continuous operation
Position of 2 axes linear interpolating continuous operation with circular arc interpolation	2000

■ Setting example of XG-PM

▪ Operating data of Main-axis

Step no.	Control method	Operating method	Goal pos[pls]	speed [pls/s]	Acc. no.	Dec. no.	M code	Dwell time	Sub axis setting
1	Absolute, Linear interpolation	singular, continuous	0	3000	No.1	No.1	0	0	Axis2
2	Absolute, Linear interpolation	singular, continuous	5000	3000	No.1	No.1	0	0	Axis2
3	Absolute, Linear interpolation	singular, end	5000	3000	No.1	No.1	0	100	Axis2

▪ Operating data of Sub-axis

Step no.	Control method	Operating method	Goal pos[pls]	speed [pls/s]	Acc. no.	Dec. no.	M code	Dwell time	Sub axis setting
1	Absolute, single axis position control	singular, end	1000	0	No.1	No.1	0	0	None
2	Absolute, single axis position control	singular, end	1000	0	No.1	No.1	0	0	None
3	Absolute, single axis position control	singular, end	4000	0	No.1	No.1	0	0	None

■ Operating pattern

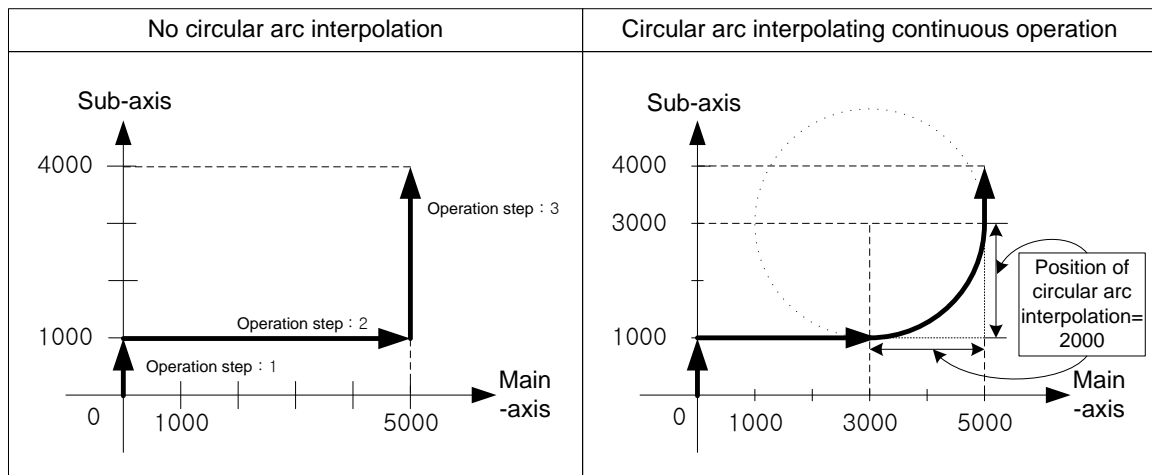

■ Description about action

When executing operation step no.1, execute linear interpolation to original goal position (0,1000) without circular arc interpolation because position to interpolate circular arc(2000) is bigger than the length of line 1(1000).

When finishing linear interpolation to goal position of operation step no.1 and executing operation step no.2, because position to interpolate circular arc(2000) is smaller than line length of step no.2(5000) and no.3(3000), so recalculate the starting position (Goal position of linear trace no.1) and the goal position (Starting position of linear trace no.2) of circular interpolation.

After continue to execute linear interpolation to the recalculated goal position of operation step no.2(3000,1000), then execute circular interpolation to recalculated starting position of operation step no.3(5000,3000).

After circular interpolation, execute linear interpolation to the goal position of operation step no.3(5000,4000), Positioning will be complete.

8.2.7 Linear Interpolation Control with 3 axes

After executed by positioning operation start command (「Indirect start」 , 「Synchronous start」), then executing interpolation control from starting position to the goal position with interpolation axis set as the main axis and sub axis.

(1) Linear interpolation control with absolute coordinates (「Absolute, Linear Interpolation」)

- (a) Execute linear interpolation with 3 axes from starting position to the goal position designated on positioning data.
Positioning control is on basis of the designated position from homing.
- (b) The direction of movement depends on the starting position and the goal position for each axis.
 - Starting position < Goal position : Positioning operation in forward
 - Starting position > Goal position : Positioning operation in reverse

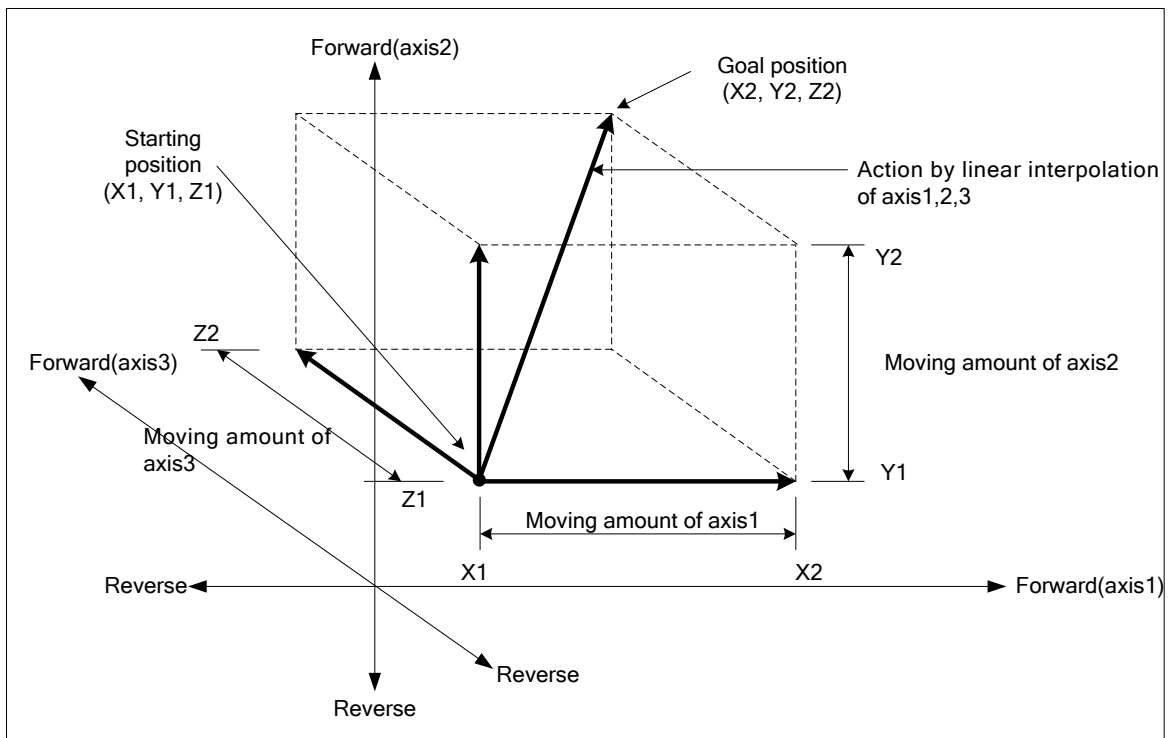

(c) Restrictions

Linear interpolation with 3 axes may not be executed in the case below.

- 「Sub axis setting」 Error (error code : 253)
 - 「Sub axis setting」 of main axis operating data is "Axis-undecided"
 - 「Sub axis setting」 of main axis operating data is the same as main axis no.
 - 「Sub axis setting」 of main axis operating data exceeds the settable axis no. of module now using
- If only one axis is set as sub axis, execute "linear interpolation control with 2 axes".

(d) Setting example of operating data

Setting items	Main-axis setting (axis1)	Sub-axis setting(axis2)	Sub-axis setting(axis3)	Description
Control method	Absolute, Linear interpolation	- ^{*1}	- ^{*1}	When linear interpolation control is executed by the method of absolute coordinates, set 「Absolute, Linear interpolation」 on the main axis
Operating method	Singular, End	-		Set the operating method to execute linear interpolation
Goal position [pls]	5000	6000	4000	Set the goal position to position on main-axis and sub-axis
Operating speed [pls/s]	1000	-		Use speed-designated method of main axis for linear interpolation
Acc. no.	No.1	-		Set acc. no. for acceleration (no.1 ~ no.4)
Dec. no.	No.2	-		Set dec. no. for deceleration. (no.1 ~ no.4)
M code	0	-		When need to execute auxiliary work synchronizing with linear interpolation
Dwell time	500	-		Set dwell time(ms) to outputting the signal positioning completion
Sub-axis setting	Axis2, Axis3	-		Set an axis to be used as sub-axis among settable axis in operating data of main-axis

^{*1} : It does not need to be set. Whatever value is set as, it does not affect linear interpolation.

Note

Linear interpolation control is executed on the basis of operating data of main axis.

Only 「Goal position」 item of sub-axis setting affect linear interpolation. In other word, whatever value is set as, it does not affect the operation and errors do not arise

Chapter 8 Functions

[Example] axis1 is main axis, axis2 and axis3 are sub axis. Execute linear interpolation by the setting as follows.

- Starting position (2000, 1000, 1000), Goal position (5000, 6000, 4000)

In this condition, the operation is as follows.

- Setting example of XG-PM

- Operating data of main-axis(axis1)

Step no.	Control method	Operating method	Goal position [pls]	Operating speed [pls/s]	Acc. no.	Dec. no.	M code	Dwell time	Sub axis setting
1	Absolute, Linear	Singular, End	5000	1000	No.1	No.1	0	100	Axis2

- Operating data of sub-axis1(axis2)

Step no.	Control method	Operating method	Goal position [pls]	Operating speed [pls/s]	Acc. no.	Dec. no.	M code	Dwell time	Sub axis setting
1	Absolute, Single axis positioning control	Singular, End	6000	0	No.1	No.1	0	0	None

- Operating data of sub-axis2(axis3)

Step no.	Control method	Operating method	Goal position [pls]	Operating speed [pls/s]	Acc. no.	Dec. no.	M code	Dwell time	Sub axis setting
1	Absolute, Single axis positioning control	Singular, End	4000	0	No.1	No.1	0	0	None

- Operating pattern

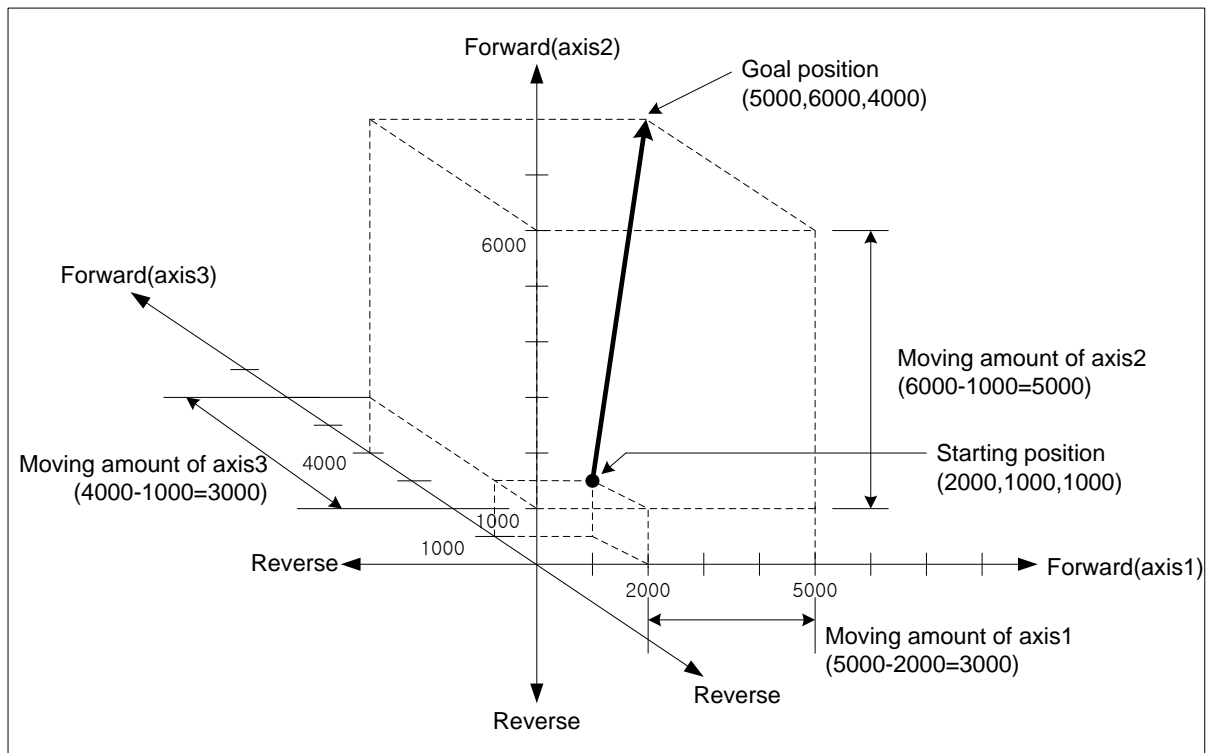

(2) Linear interpolation control with relative coordinates (「Relative, Linear Interpolation」)

- (a) Execute 3 axes linear interpolation from starting position to the goal position. Positioning control is on basis of the current stop position.
- (b) Moving direction depends on the sign of the goal position (Moving amount)
- The sign is positive (+ or nothing) : Positioning operation in forward
 - The sign is negative (-) : Positioning operation in reverse

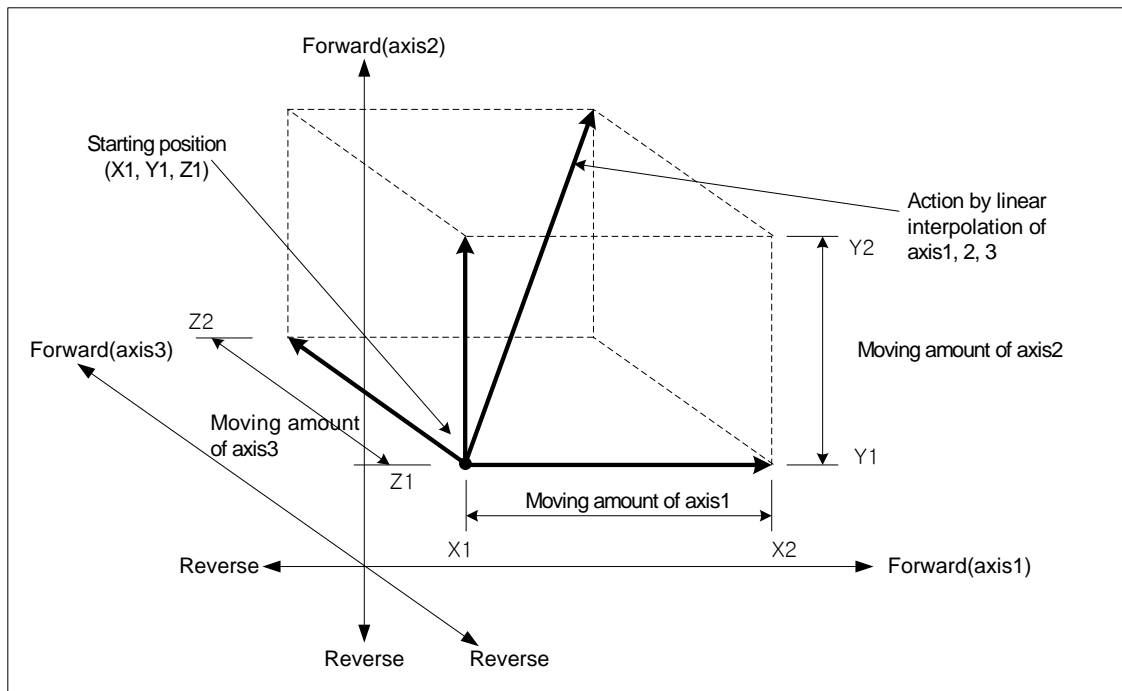

(c) Restrictions

Linear interpolation with 3 axes may not be executed in the case below.

- 「Sub-axis setting」 error (error code : 253)
 - 「Sub-axis setting」 value of main axis operating data is "Axis-undecided"
 - 「Sub-axis setting」 value of main axis operating data is same as the main axis no.
 - 「Sub-axis setting」 value of main axis operating data exceeds settable axis no.
- If only one axis is set as sub axis, execute "linear interpolation control with 2 axes".

Chapter 8 Functions

(d) Setting example of operating data

Setting items	Main-axis setting (axis1)	Sub-axis setting(axis2)	Sub-axis setting(axis3)	Description
Control method	Absolute, Linear interpolation	- *1	- *1	When linear interpolation control is executed by the method of absolute coordinates, set 「Absolute, Linear interpolation」 on the main axis
Operating method	Singular, End	-		Set the operating method to execute linear interpolation
Goal position[pls]	5000	6000	4000	Set the goal position to position on main-axis and sub-axis
Operating speed[pls/s]	1000	-		Use speed-designated method of main axis for linear interpolation
Acc. no.	No.1	-		Set acc. no. for acceleration (no.1 ~ no.4)
Dec. no.	No.2	-		Set dec. no. for deceleration (no.1 ~ no.4)
M code	0	-		When need to execute auxiliary work synchronizing with linear interpolation
Dwell time	500	-		Set dwell time(ms) to outputting the signal positioning completion
Sub-axis setting	Axis2, Axis3	-		Set an axis to be used as sub-axis among settable axis in operating data of main-axis

- *1 : It does not need to be set. Whatever value is set as, it does not affect linear interpolation.

Note

Linear interpolation control is executed on the basis of operating data of main axis.

Only 「Goal position」 item of sub-axis setting affect linear interpolation. In other word, whatever value is set as, it does not affect the operation and errors do not arise.

[Example] axis1 and axis2 are main and sub axis each. Execute linear interpolation by the setting as follows

- Starting position (2000, 1000, 1000), Goal position (5000, 6000, 4000) : In this condition, the operation is as follows.
- Setting example of XG-PM

▫ Operating data of main-axis(axis1)

Step no.	Control method	Operating method	Goal position [pls]	Operating speed [pls/s]	Acc. no.	Dec. no.	M code	Dwell time	Sub axis setting
1	Absolute, Linear	Singular, End	5000	1000	No.1	No.1	0	100	Axis2

▫ Operating data of sub-axis1 (axis2)

Step no.	Control method	Operating method	Goal position [pls]	Operating speed [pls/s]	Acc. no.	Dec. no.	M code	Dwell time	Sub axis setting
1	Absolute, Single axis positioning control	Singular, End	6000	0	No.1	No.1	0	0	None

▫ Operating data of sub-axis2(axis3)

Step no.	Control method	Operating method	Goal position [pls]	Operating speed [pls/s]	Acc. no.	Dec. no.	M code	Dwell time	Sub axis setting
1	Absolute, Single axis positioning control	Singular, End	4000	0	No.1	No.1	0	0	None

■ Operating pattern

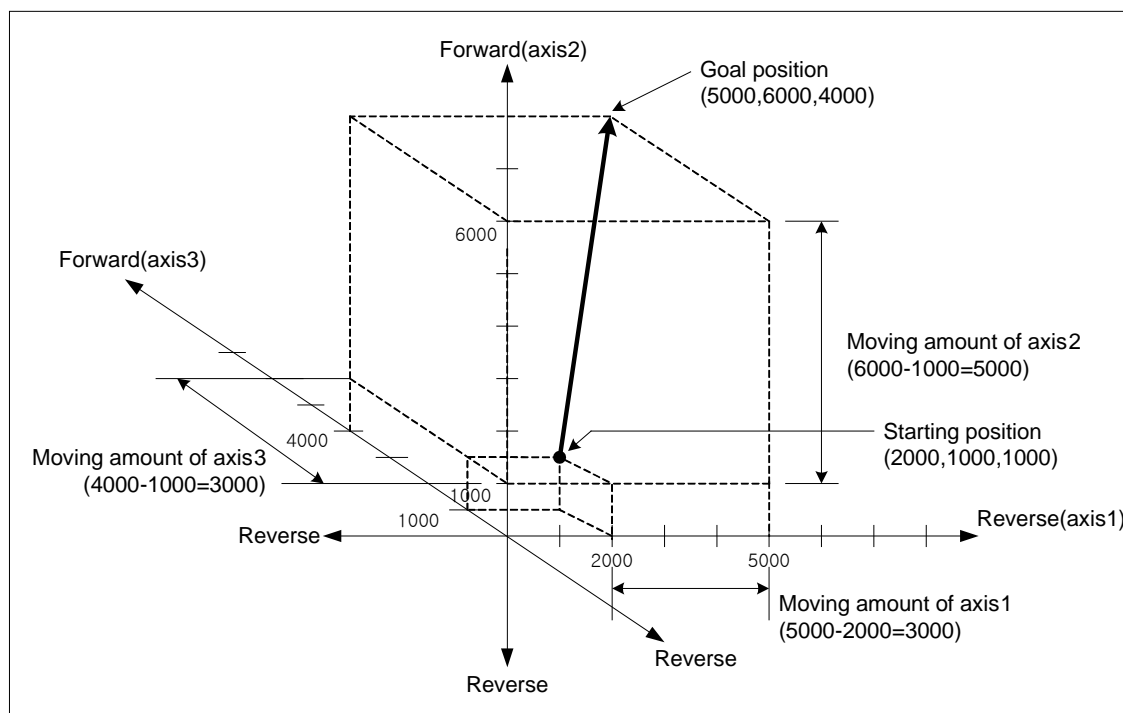

Chapter 8 Functions

(3) Speed in 3 axes linear interpolation control

Operating speed in linear interpolation is according to the method of main-axis designating. After operating speed is set on command axis (main), the designated axis for interpolation is operated by embedded positioning module's calculating each moving amount. Speed of sub-axis and actual speed of machine are calculated as follows.

■ Speed in 3 axes linear interpolation

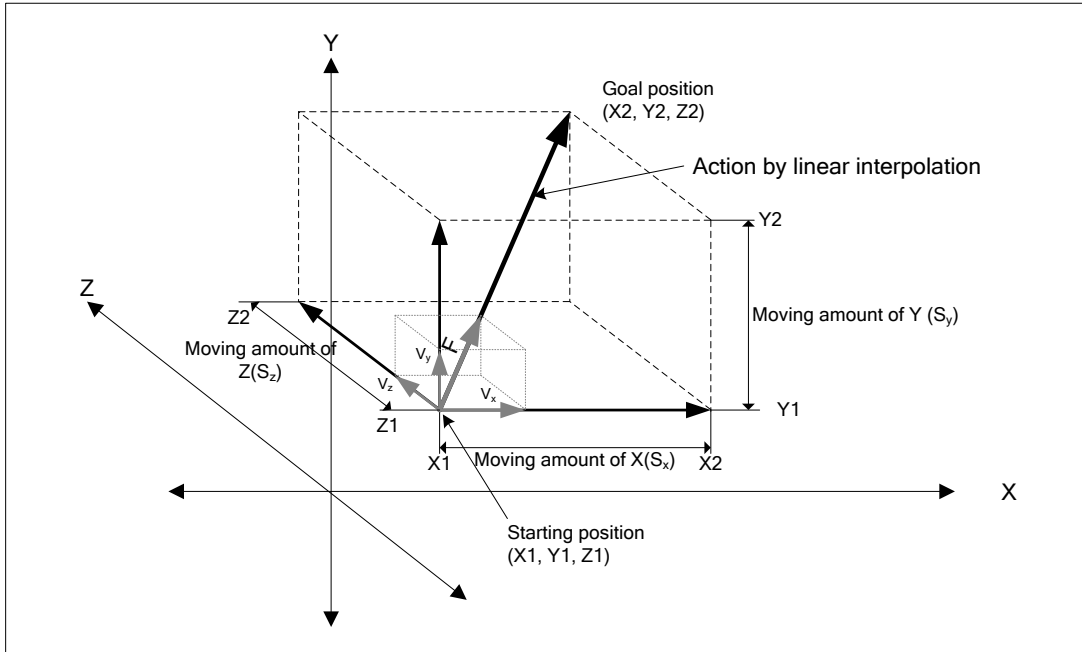

$$\text{Speed of sub}(V_y) = \text{Speed of main}(V_x) \times \frac{\text{Moving amount of Sub}(S_y)}{\text{Moving amount of Main}(S_x)}$$

$$\text{Speed of sub}(V_z) = \text{Speed of main}(V_x) \times \frac{\text{Moving amount of sub}(S_z)}{\text{Moving amount of main}(S_x)}$$

$$\text{Interpolating speed}(F) = \sqrt{V_x^2 + V_y^2 + V_z^2}$$

[Example]

- Starting position (2000, 1000, 1000)
- Goal position (6000, 5000, 6000)
- Operating speed : 400 [pls/s]

Speed of sub-axis and interpolating speed are as follows.

$$\text{Speed of sub-axis1} = 400 \times \frac{3000}{4000} = 300 \text{ [pls/s]}$$

$$\text{Speed of sub-axis2} = 400 \times \frac{5000}{4000} = 500 \text{ [pls/s]}$$

$$\text{Interpolating speed} = \sqrt{400^2 + 300^2 + 500^2} \approx 707 \text{ [pls/s]}$$

Note

(1) Speed limit for Sub-axis

When using linear interpolation control and moving distance of main < moving distance of sub, it is possible that sub-axis speed calculated by embedded positionig module exceeds 「Speed limit」 of basic parameter. In this case, error (error code : 261) arises and sub-axis speed is recalculated, then sub-axis continues to operate. To prevent that errors arise, operate it at the speed below limit.

(2) The speed when the distance main-axis moved is 0

When the distance main-axis moved is 0, the operating speed of main-axis operating data becomes actual interpolating speed.

In case of linear interpolation with more than 3 axes, the speed of sub-axis is calculated by the formula below.

$$\text{Speed of sub-axis } (V_y) = \text{Interpolating speed } (F) \times \frac{\text{Moving amount of sub-axis } (S_y)}{\text{Merged moving amount } (S_f)}$$

$$\text{Speed of sub-axis } (V_z) = \text{Interpolating speed } (F) \times \frac{\text{Moving amount of sub-axis } (S_z)}{\text{Merged moving amount } (S_f)}$$

8.2.8 Linear Interpolation Control with 4 axes

After executed by positioning operation start command (「Indirect start」, 「Synchronous start」), then executing interpolation control from starting position to the goal position with interpolation axis set as the main axis and sub axis. Combination of interpolation axis is unlimited and maximum 4 axes linear interpolation control is available. Characteristics of action are same as linear interpolation control with 3 axes. For the details, refer to linear interpolation control with 3 axes.

(1) Linear interpolation control with absolute coordinates (「Absolute, Linear Interpolation」)

- (a) Execute linear interpolation from starting position to the goal position designated on positioning data. Positioning control is on basis of the designated position from homing.
- (b) The direction of movement depends on the starting position and the goal position for each axis.
 - Starting position < Goal position : Positioning operation in forward
 - Starting position > Goal position : Positioning operation in reverse

(2) Linear interpolation control with relative coordinates (「Relative, Linear Interpolation」)

- (a) Execute 4 axes linear interpolation from starting position to the goal position. Positioning control is on basis of the current stop position.
- (b) Moving direction depends on the sign of the goal position (Moving amount)
 - The sign is positive (+ or nothing) : Positioning operation in forward
 - The sign is negative (-) : Positioning operation in reverse

(3) Speed in 4 axes linear interpolation control

Operating speed in linear interpolation is according to the method of main-axis designating. After operating speed is set on command axis (main), the designated axis for interpolation is operated by embedded positioning module's calculating each moving amount. Speed of sub-axis and actual speed of machine are calculated as follows.

$$\text{Speed of sub - axis(axis2)} (V_2) = \text{Speed of main - axis}(V_1) \times \frac{\text{Moving amount of sub - axis}(S_2)}{\text{Moving amount of main - axis}(S_1)}$$

$$\text{Speed of sub - axis(axis3)} (V_3) = \text{Speed of main - axis}(V_1) \times \frac{\text{Moving amount of sub - axis}(S_3)}{\text{Moving amount of main - axis}(S_1)}$$

$$\text{Speed of sub - axis(axis4)}(V_4) = \text{Speed of main - axis}(V_1) \times \frac{\text{Moving amount of sub - axis}(S_4)}{\text{Moving amount of main - axis}(S_1)}$$

$$\text{Interpolating Speed} (F) = \sqrt{V_1^2 + V_2^2 + V_3^2 + V_4^2}$$

8.2.9 Designate Midpoint of Circular Interpolation

It was progressed by start command of positioning operation (「Indirect start」, 「direct start」) and operate interpolation following the path of circular which is through midpoint that is set by 2 axes.

And, Can progress circular interpolation of over 360 degrees by the set number of circular interpolation.

The combination of 2 axes for circular interpolation is unlimited. User can randomly use 2 axes from axis 1 to axis 4.

(1) Control of circular interpolation by absolute coordinate, designate midpoint(Absolute, circular interpolation)

- (a) Operate circular interpolation from starting point and pass the midpoint that is set operation data to target point.
- (b) To be made path of circular interpolation with start position, midpoint and a crossing which is perpendicular divide equally position of midpoint and target position.
- (c) Movement direction is decided automatically depends on set target position and auxiliary point of circular interpolation.

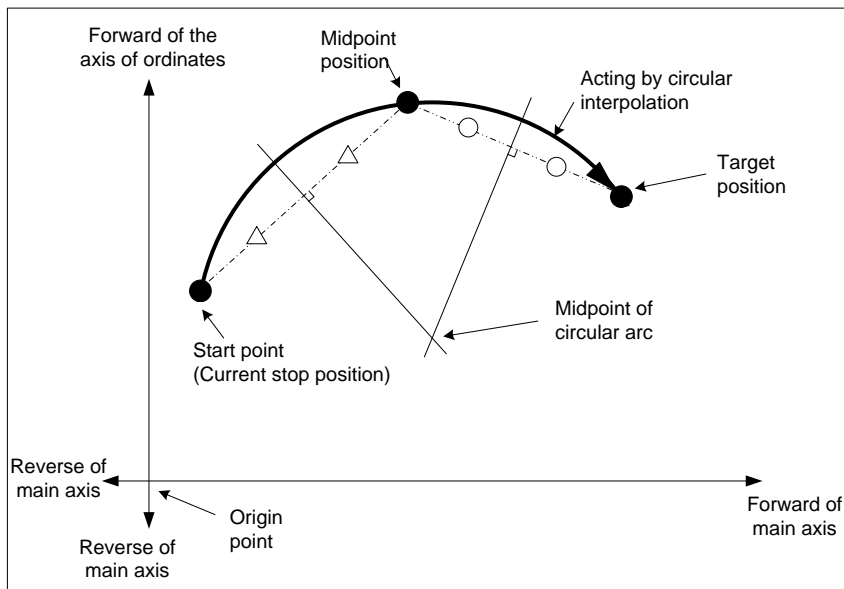

(d) Restriction

- User can't draw circle which is starting point same with last point on the circular interpolation of midpoint designation method. If you want to draw circle, please use method of midpoint.
- User cannot progress circular interpolation of midpoint designation method with following cases.
 - 「Sub axis setting」 disorder (Error code : 279)
 - In case of the value of 「Sub axis setting」 of main axis operation data is no setting axis
 - In case of the value of 「Sub axis setting」 of the main axis operation data same with the number of main axis,
 - In case of value of 「Sub axis setting」 of main axis operation data exceed the axis No. of module which is can set.
 - In case of "degree" is set as item of main axis or sub axis, (Error code : 282(Main axis), 283(Sub axis))
 - Midpoint that is designated as auxiliary point same with start position or target position. (Error code : 284)
 - In case of start position same with target position (Error code : 285)
 - In case of calculated radius of circular arc exceed 2147483647pls (Error code : 286)
 - In case of auxiliary position and target position in a straight line from start position, (Error code : 287)

Chapter 8 Functions

Note

Have to be careful, because 2 axes work both in the circular interpolation maneuver.

(1) Available auxiliary operation is as follows ;

- Speed override, Deceleration stop, Emergency stop, Skip operation

(2) Operation of circular interpolation unavailable command is as follows ;

- Position/Speed conversion control, Position override, Continuous operation

(3) The parameter item which is operated by set value of each axis is as follows ;

- amount of compensate of Backlash, high limit of software, low limit of software on the item of expansion parameter

(e) Example of setting operation data

Setting item	Main axis (axis1) setting	Sub axis (axis 2) setting	Contents
Control method	Absolute, circular interpolation	- *1	Set 「absolute, circular interpolation」 on main axis, when control circular interpolation by absolute coordinates.
Operation method	Singleness, End	-	Set operation method for circular interpolation.
Target position [pls]	10000	0	Set the target position for positioning on the main axis and sub axis.
Operation speed [pls/s]	1000	-	Circular interpolation use method of designating composition speed
Acceleration speed	No.1	-	Set the acceleration time No. for acceleration. (No.1 ~ 4)
Deceleration speed	No.2	-	Set the deceleration time No. for deceleration. (No.1 ~ 4)
M code	0	-	Set it for progressing auxiliary operation depends on circular interpolation operation.
Dwell time	500	-	set the dwell time taken until plc outputs the signal which informs users of finishing the position decision
The axis of ordinates setting	Axis 2	-	Set axis as sub axis among settable axes of module which is using for now on the main axis operation data.
Circular interpolation Auxiliary point	5000	5000	Set midpoint for passing circular arc on the method of the designating midpoint.
Circular interpolation mode	Midpoint	-	In case of using the method of designating midpoint, set 「midpoint」 on the main axis.
Circular interpolation The number of rotations	0	-	When user want to draw circle which is over 360 degrees, set the number of rotations of circular arc.
Helical interpolation	Do not use	-	In case of using circular interpolation, set 「Do not use」 on the main axis.

*1 : Do not need setting. Whatever you set, there is no effect to circular interpolation.

Note

The circular interpolation control of the method of designating midpoint operate by standards of set item on the operation data of main axis (command axis).

When circular interpolation operation of the method of designating midpoint, there is no effect except for 「Target position」, 「Auxiliary point of circular interpolation」 on the axis of setting. What ever you take for the value, there is no effect to operate, there is no error.

[Example] Operate circular interpolation of designating midpoint and absolute coordinate (main axis; axis 1, sub axis; axis 2)

■ In case of Start position (0, 0), Target position (10000, 6000), Auxiliary point (2000, 6000), operation is as follows;

■ Example of setting in the XG-PM

▪ Main axis(axis1) operation data

Step No.	Control Method	Operation method	Target position [pls]	Operation Speed [pls/s]	Acc. Speed	Dec. Speed	M code	Dwell time	Sub axis setting	Circular interpolation Auxiliary point	Circular interpolation mode	The number of rotations of Circular interpolation	Helical interpolation
1	Absolute, Circular interpolation	Singleness, End	13000	1000	No. 1	No. 1	0	100	Axis 2	10000	Midpoint	0	Do not use

▪ The axis(axis 2) of ordinates operation data

Step No.	Control Method	Operation method	Target position [pls]	Operation Speed [pls/s]	Acc. Speed	Dec. speed	M code	Dwell time	Sub axis setting	Circular interpolation Auxiliary point	Circular interpolation mode	The number of rotations of Circular interpolation	Helical interpolation
1	Absolute, Reduction positioning control	Singleness End	9000	0	No. 1	No. 1	0	0	Do not setting axis	7500	Midpoint	0	Do not use

■ Operation pattern

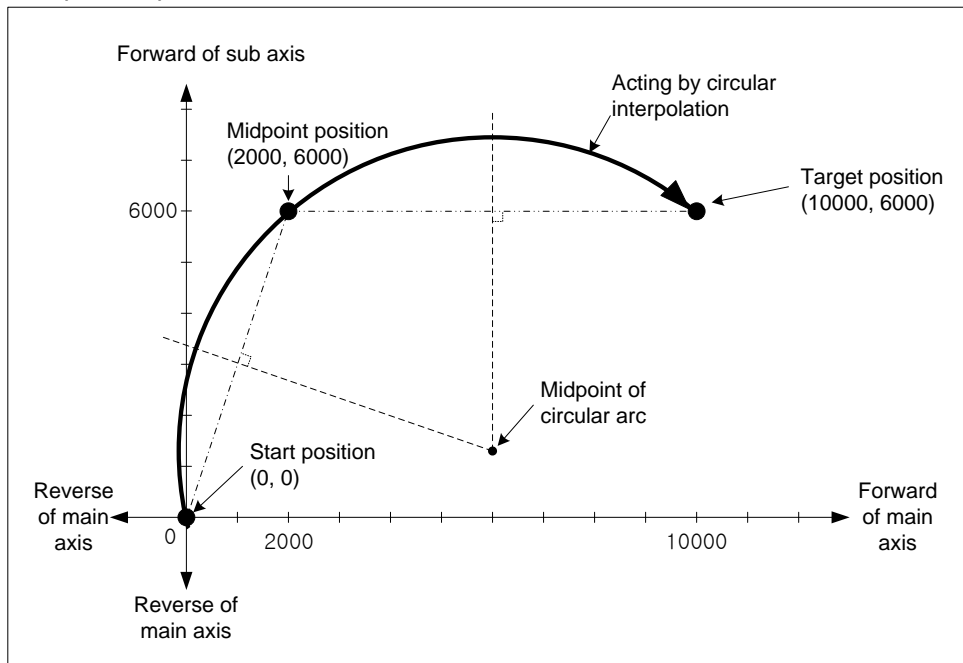

Chapter 8 Functions

(2) Circular interpolation by relative coordinates, the method of designating midpoint (Relative, circular interpolation)

- Operate circular interpolation from start position and go through midpoint to target position as amount of set movement.
- Midpoint position is the incremented position as set value on 「the circular interpolation auxiliary point」 from current stop position.
- The intersection of perpendicular bisectors of starting position and midpoint, the current stop position and the goal position will be the center-point of the arc.
- Movement direction is decided by set target position and circular interpolation auxiliary point.

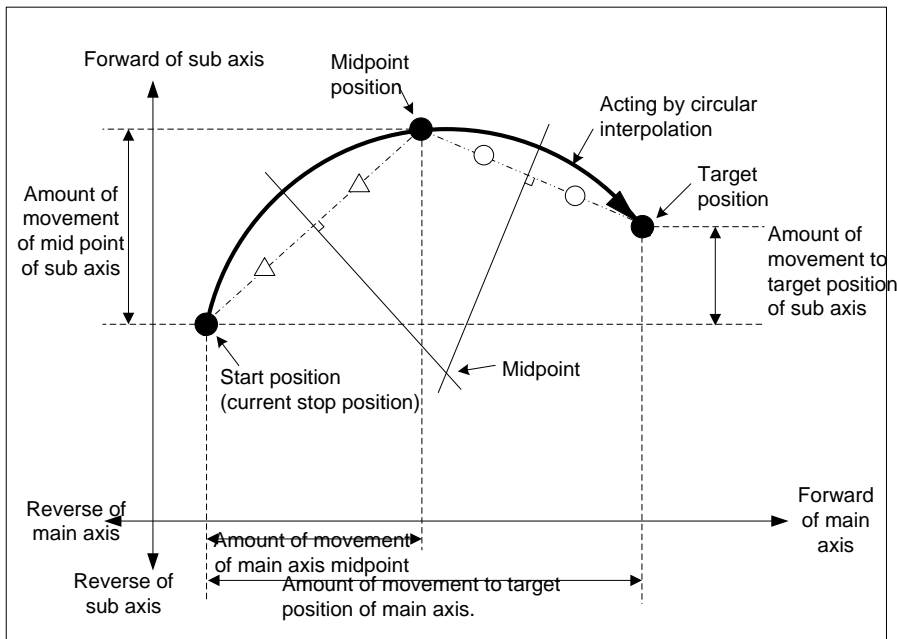

(e) Restriction

- Can not draw circle which starting point is the same with last point on the circular interpolation of the method of designating midpoint. When want to draw circle, should use midpoint method.
- In this following case, it will be error and can not working circular interpolation of method of designating midpoint.
 - 「Sub axis setting」 disorder (Error code : 279)
 - It is axis-undecided that the value of sub axis of main axis operation data.
 - The value of 「Sub axis setting」 of main axis operation data is set is same with main axis No.
 - The value of 「Sub axis setting」 of main axis operation data exceed axis No. of settable module which is using.
 - In case of "Degree" is set as control item of main/sub axis. (Error code : 282(Main axis), 283(Sub axis))
 - In case of midpoint which is designated as auxiliary point is same with start position and target position. (Error code : 284)
 - In case of start position same with target position. (Error code : 285)
 - Radius of calculated circle exceed 2147483647pls (Error code : 286)
 - Start position is in alignment with auxiliary position and target position. (Error code : 287)

(f) Example of operation data setting

Setting item	Main axis(axis 1) setting	Sub axis(axis 2) setting	Contents
Control method	Relative, Circular interpolation	- *1	When control circular interpolation by relative coordinates, set 「relative, circular interpolation」 on main axis.
Operation method	Singleness, End	-	Set operation method for circular interpolation.
Target position [pls]	10000	0	Set target position as a amount of increment of stop position for positioning on the main axis, sub axis.
Operation speed [pls/s]	1000	-	Circular interpolation use method of designating composition speed. Set composition speed on the main axis.
Acceleration speed	No.1	-	Set acceleration time No. for acceleration. (No.1 ~ No.4)
Deceleration speed	No. 2	-	Set deceleration time No. for deceleration. (No.1 ~ No.4)
M code	0	-	Set it when user wants to progress other auxiliary action with circular interpolation operation.
Dwell time	500	-	set the dwell time taken until plc outputs the signal which informs users of finishing the position decision
Sub axis setting	Axis 2	-	Set axis among the settable axes of current module on the main axis operation for sub.
Circular interpolation auxiliary point	5000	5000	Set the middle point that the arc with mid-point designating method would pass by as an increment from the current stop position
Circular interpolation mode	Midpoint	-	Set "midpoint", when use method of designating midpoint.
The number of rotations of circular interpolation	0	-	Set the number of rotations for drawing circle that it is over 360 degrees.
Helical interpolation	Not use	-	Set "not use", when use circular interpolation.

- *1 : Do not need setting. Whatever user set, there is no effect to circular interpolation.

Note

Circular interpolation of method of designating midpoint is depends on item that it is set on operation data of main axis (command axis).

There is no effect to circular interpolation operation except for 「Target position」 and 「Circular interpolation auxiliary point」, when operate circular interpolation of method of designating midpoint. Whatever user set, there is no effect and no error.

Chapter 8 Functions

[Example] Operate circular interpolation of method of designating relative coordinate midpoint with axis 1 (main axis), with axis 2 (sub axis)

■ Start position : (1000, 1000)

Target position (amount of movement) setting : (8000, 4000)

Auxiliary point (amount of movement) setting : (5000, 5000)

In this case operation is as follows:

■ Example of setting XG-PM

▪ Main axis(axis 1) Operation data

Step No.	Control Method	Operation method	Target position [pls]	Operation Speed [pls/s]	Acc. Speed	Dec. Speed	M code	Dwell time	Sub axis setting	Circular interpolation Auxiliary point	Circular interpolation mode	The number of rotations of Circular interpolation	Helical interpolation
1	Relative, Circular interpolation	Singleness, End	8000	1000	No. 1	No. 1	0	100	Axis 2	5000	Midpoint	0	Do not use

▪ Sub axis(axis 2) Operation data

Step No.	Control Method	Operation method	Target position [pls]	Operation Speed [pls/s]	Acc. Speed	Dec. Speed	M code	Dwell time	Sub axis setting	Circular interpolation Auxiliary point	Circular interpolation mode	The number of rotations of Circular interpolation	Helical interpolation
1	Absolute, Reduction positioning control	Singleness, End	4000	0	No. 1	No. 1	0	0	Axis-undecided	5000	Midpoint	0	Do not use

■ Operation pattern

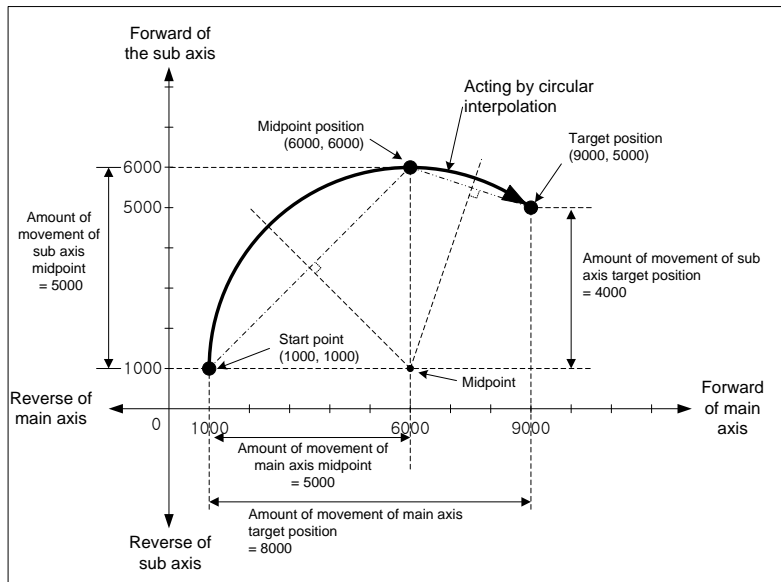

8.2.10 Circular interpolation control of designating midpoint

Operate interpolation up to trace of the circle after operate by starting command of positioning operation (「indirect start」 , 「Start at a time」). And then, Midpoint is center of circle and it is move to rotation direction of circular interpolation.

「The number of rotations of circular interpolation」 can operate circular interpolation which is over 360 degrees with setting value.

There is no limit for composition of axis 2 that it needs to use circular interpolation control. User can select 2 axes from axis1 to axis 4 randomly.

(1) Circular interpolation by method of absolute coordinate, designating midpoint

(Absolute, Circular interpolation)

(a) Operate from start position and circular interpolate to target position with the trace of circle. And the circle has radius which distance is to set midpoint position. 「Circular interpolation auxiliary point」 is midpoint of this circle.

(b) Moving direction depends on set direction on “circular interpolation mode” of operation data.

- 「Midpoint, CW」 - Circular interpolation go clockwise from current position.
- 「Midpoint, CCW」 - Circular interpolation go counterclockwise from current position.

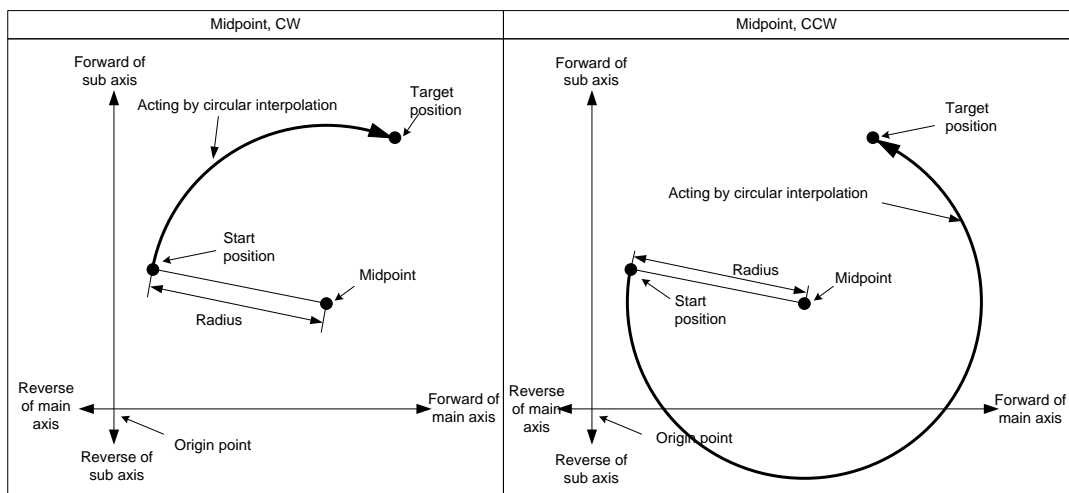

Chapter 8 Functions

(c) If target position is same with start position, can progress circular interpolation. And the circle radius is distance from midpoint to starting position (=target position)

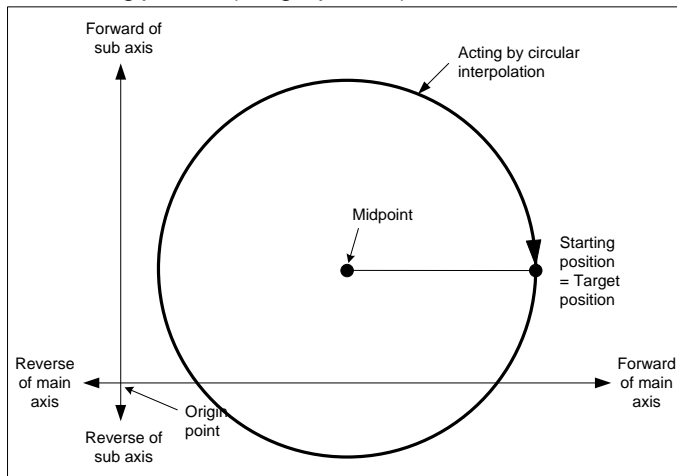

(d) Condition

- In this following case, to be error and can not progress circular interpolation control of method of designating midpoint.
 - 「Sub axis setting」 disorder (Error code : 279)
 - In case of the value of 「Sub axis setting」 of main axis operation data is "axis-undecided",
 - In case of the value of 「Sub axis setting」 of main axis operation data is same with main axis No. by setting.
 - In case of the value of 「Sub axis setting」 of main axis operation data exceed settable axis No.
 - In case of "degree" is set as item of main/sub axis control, (Error code : 282(Main axis), 283(Sub axis))
 - In case of midpoint which is set as auxiliary point is same with starting/target position, (Error code : 284)
 - In case of calculated radius of circle exceed 2147483647pls, (Error code : 286)

Note

Should be careful during starting circular interpolation, because 2 axes act at a time.

1. Available auxiliary operation is as follows:

- Speed override, Deceleration stop, Emergency stop, Skip operation

2. Unavailable command with circular interpolation is as follows:

- Position/Speed conversion control, Position override, Consecutive operation

3. The parameter item that it is operated by set value each axes is as follows:

- Amount of backlash compensation of expansion parameter item, Software high limit, Software low limit

(e) Example of operation data setting

Setting item	Main axis(axis1) setting	Sub axis(axis2) setting	Contents
Control method	Absolute, Circular interpolation	- *1	When control circular interpolation by relative coordinates, set 「relative, circular interpolation」 on main axis.
Operation method	Singleness, End	-	Set operation method for circular interpolation.
Target position [pls]	10000	0	Set target position as a amount of increment of stop position for positioning on the main axis, sub axis.
Operation speed [pls/s]	1000	-	Circular interpolation use method of designating composition speed. Set composition speed on the main axis.
Acceleration speed	No.1	-	Set acceleration time No. for acceleration. (No.1 ~ No.4)
Deceleration speed	No.2	-	Set deceleration time No. for deceleration. (No.1 ~ No.4)
M code	0	-	Set it when user wants to progress other auxiliary action with circular interpolation operation.
Dwell time	500	-	set the dwell time taken until plc outputs the signal which informs users of finishing the position decision
Sub axis setting	Axis 2	-	Set axis among the settable axes of current module on the main axis operation for sub.
Circular interpolation auxiliary point	5000	-5000	Set the center-point on the method of designating center-point.
Circular interpolation mode	Midpoint, CW	-	In case of using the method of designating center-point, set the 「center-point, CW」 or 「center-point, CCW」 by moving direction of circular arc.
The number of rotations of circular interpolation	0	-	Set the number of rotations for drawing circle that it is over 360 degrees.
Helical interpolation	Not use	-	Set "not use", when use circular interpolation.

- *1 : Do not need setting. Whatever user set, there is no effect to circular interpolation.

Note

Circular interpolation of method of designating midpoint is depends on item that it is set on operation data of main axis (command axis).

There is no effect to circular interpolation operation except for 「Target position」 and 「Circular interpolation auxiliary point」, when operate circular interpolation of method of designating midpoint. Whatever user set, there is no effect and no error.

Chapter 8 Functions

[Example] Operate circular interpolation of designating midpoint and absolute coordinate (main axis; axis 1, sub axis; axis 2)

■ In case of Start position (0, 0), Target position (0, 0), Auxiliary point (1000, 1000), direction of rotation :CW operation is as follows;

■ Example of setting in the XG-PM

▪ Main axis(axis1) operation data

Step No.	Control Method	Operation method	Target position [pls]	Operation Speed [pls/s]	Acc. Speed	Dec. Speed	M code	Dwell time	Sub axis setting	Circular interpolation Auxiliary point	Circular interpolation mode	The number of rotations of Circular interpolation	Helical interpolation
1	Absolute, Circular interpolation	Singleness, End	0	1000	No. 1	No. 1	0	100	Axis 2	1000	Centerpoint, CW	0	Do not use

▪ Sub axis(axis 2) operation data

Step No.	Control Method	Operation method	Target position [pls]	Operation Speed [pls/s]	Acc. Speed	Deceleration Speed	M code	Dwell time	Sub axis setting	Circular interpolation Auxiliary point	Circular Interpolation mode	The number of rotations of Circular interpolation	Helical interpolation
1	Absolute, Reduction positioning control	Singleness, End	0	0	No.1	No.1	0	0	Axis-undecided	1000	Centerpoint	0	Do not use

■ Operation pattern

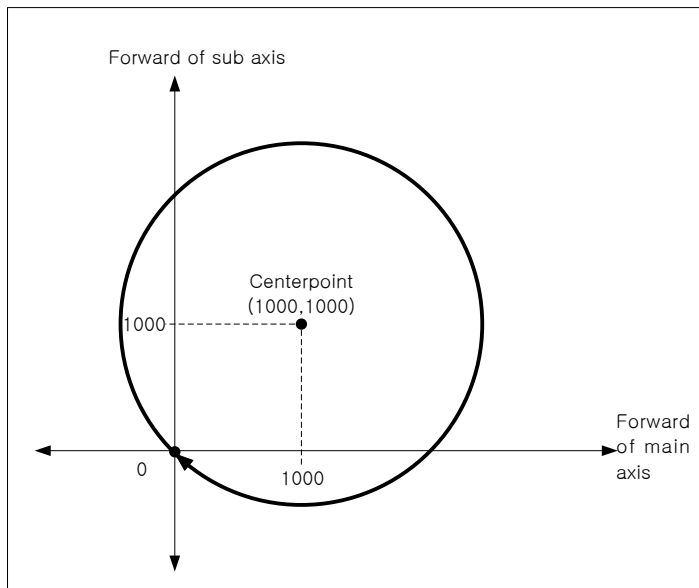

(2) Circular interpolation control by the method of relative coordinate, designating center-point

(「Relative, Circular interpolation」)

(a) Start operating at starting position and then execute circular interpolation by moving amount already set, along the trace of the arc which has a distance between starting position and designated mid-point as radius. 「Circular interpolation auxiliary point」 means the moving amount between the current position and mid-point.

(b) Moving direction is decided to set direction on “circular interpolation mode” of operation data.

- 「Center-point, CW」 - Circular interpolation go clockwise from current position..
- 「Center-point, CCW」 - Circular interpolation go counterclockwise from current position.

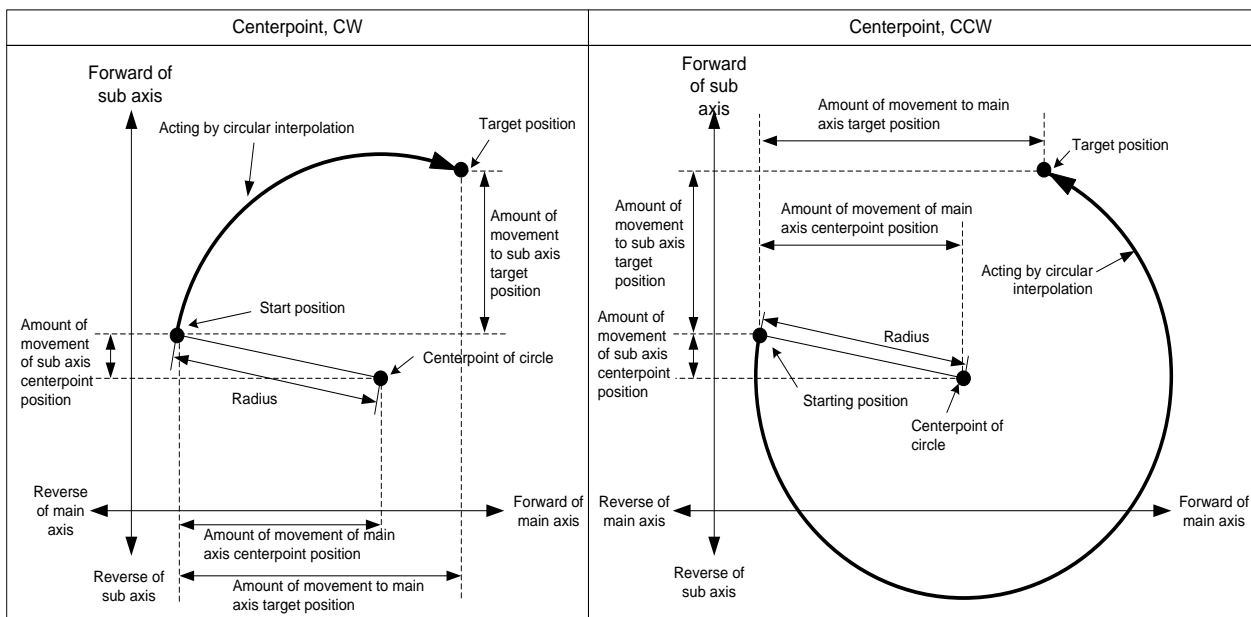

(c) If set target position of main axis and sub axis as “0”, then starting position will be same with target position and can progress circular interpolation that it is drawing circle. The radius of the circle is distance from starting position to center-point.

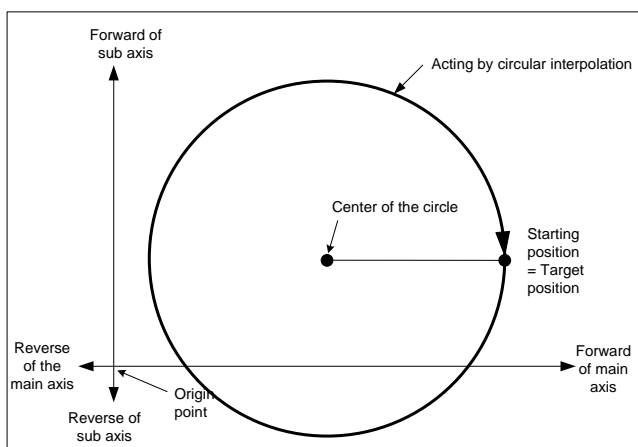

Chapter 8 Functions

(d) Condition

- User cannot progress circular interpolation of midpoint designation method with following cases.
 - 「Sub axis setting」 disorder (Error code: 279)
 - In case of the value of 「Sub axis setting」 of main axis operation data is no setting axis,
 - In case of the value of 「Sub axis setting」 of the main axis operation data same with the number of main axis,
 - In case of value of 「Sub axis setting」 of main axis operation data exceed the axis No. of module which is can set ,
 - In case of “degree” is set as item of main axis or sub axis, (Error code: 282(Main axis), 283(Sub axis))
 - Midpoint that is designated as auxiliary point same with start position or target position. (Error code: 284)
 - In case of start position same with target position (Error code: 285)
 - In case of calculated radius of circular arc exceed 2147483647pls (Error code: 286)

(e) Example of operation data setting

Setting item	Main axis(axis1) setting	Sub axis(axis2) setting	Contents
Control method	Relative, Circular interpolation	- *1	When control circular interpolation by relative coordinates, set 「relative, circular interpolation」 on main axis.
Operation method	Singleness, End	-	Set operation method for circular interpolation.
Target position [pls]	10000	0	Set target position as the amount of increment of stop position for positioning on the main axis, sub axis.
Operation speed [pls/s]	1000	-	Circular interpolation use method of designating composition speed. Set composition speed on the main axis.
Acceleration speed	No.1	-	Set acceleration time No. for acceleration. (No.1 ~ No.4)
Deceleration speed	No.2	-	Set deceleration time No. for deceleration. (No.1 ~ No.4)
M code	0	-	Set it when users want to progress other auxiliary action with circular interpolation operation.
Dwell time	500	-	set the dwell time taken until plc outputs the signal which informs users of finishing the position decision
Sub axis setting	Axis 2	-	Set axis among the settable axes of current module on the main axis operation for sub.
Circular interpolation auxiliary point	5000	-5000	Set the center-point position by amount of increment of current stop position on the method of designating center-point.
Circular interpolation mode	Midpoint, CW	-	In case of using the method of designating center-point, set the 「center-point, CW」 or 「center-point, CCW」 by moving direction of circular arc.
The number of rotations of circular interpolation	0	-	Set the number of rotations for drawing circle that it is over 360 degrees.
Helical interpolation	Not use	-	Set “not use”, when use circular interpolation.

- *1 : Do not need setting. Whatever user set, there is no effect to circular interpolation.

Note

Circular interpolation of method of designating midpoint is depends on item that it is set on operation data of main axis command axis).

There is no effect to circular interpolation operation except for 「Target position」 and 「Circular interpolation auxiliary point」, when operate circular interpolation of method of designating midpoint. Whatever user set, there is no effect and no error.

[Example] Operate circular interpolation of the method of designating relative coordinate centerpoint with axis 1 (main axis), with axis 2 (sub axis)

■ Start position: (0, 0)

Target position (amount of movement) setting: (2000, 0)

Auxiliary point (amount of movement) setting: (1000, 0)

Direction of rotations: CW

In this case operation is as follows:

■ Example of setting XG-PM

▪ Main axis (axis 1) Operation data

Step No.	Control Method	Operation method	Target position [pls]	Operation Speed [pls/s]	Acc. Speed	Dec. Speed	M code	Dwell time	Sub axis setting	Circular interpolation Auxiliary point	Circular Interpolation mode	The number of rotations of Circular interpolation	Helical Interpolation
1	Relative, Circular interpolation	Singleness, Continue	2000	1000	No. 1	No. 1	0	100	Axis 2	1000	Center-point ,CW	0	Do not use
1	Relative, Circular interpolation	Singleness, End	2000	1000	No. 1	No. 1	0	100	Axis 2	1000	Center-point ,CW	0	Do not use

▪ Sub axis (axis 2) Operation data

Step No.	Control Method	Operation method	Target position [pls]	Operation Speed [pls/s]	Acc. Speed	Dec. Speed	M code	Dwell time	Sub axis setting	Circular interpolation Auxiliary point	Circular Interpolation mode	The number of rotations of Circular interpolation	Helical interpolation
1	Absolute, Reduction positioning control	Singleness, End	0	0	No. 1	No. 1	0	0	Axis-undecided	0	Midpoint ,CW	0	Do not use
1	Absolute, Reduction positioning control	Singleness, End	0	0	No. 1	No. 1	0	0	Axis-undecided	0	Midpoint ,CW	0	Do not use

■ Operation pattern

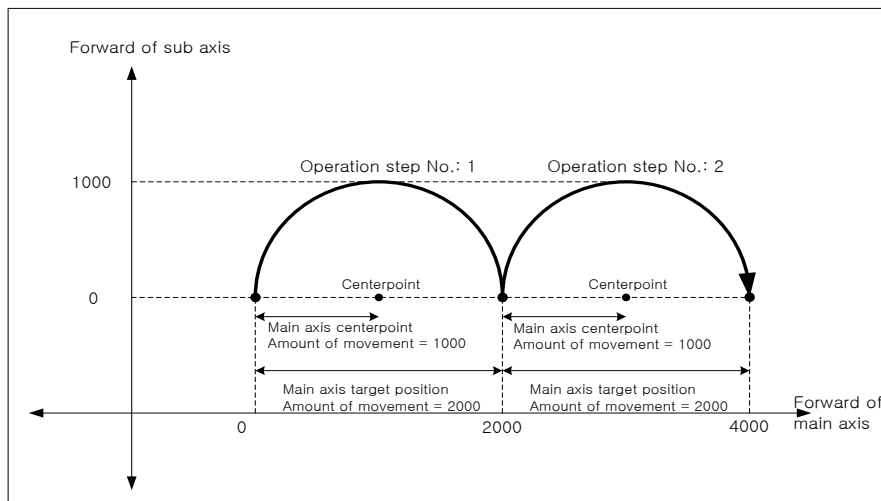

Chapter 8 Functions

(3) Circular interpolation control which radius of starting point is different with radius of ending point.

(「Relative, Circular interpolation」)

(a) According to set value of target position, distance A which it is distance from start point to center point is different with distance B which it is distance from target position to center point (End point, Radius) on circular interpolation control of the method of designating center point. Sometimes do not operate normally.

When starting point radius have difference with end point radius, calculate each speed on the set operation speed, and operate circular interpolation control with compensating radius.

(b) In case of starting point radius has some difference with ending point radius, compensating speed is as follows:

- Radius of starting point > Radius of ending point: The more near from target position, the slower.
- Radius of starting point < Radius of ending point: The more near from target position, the faster.

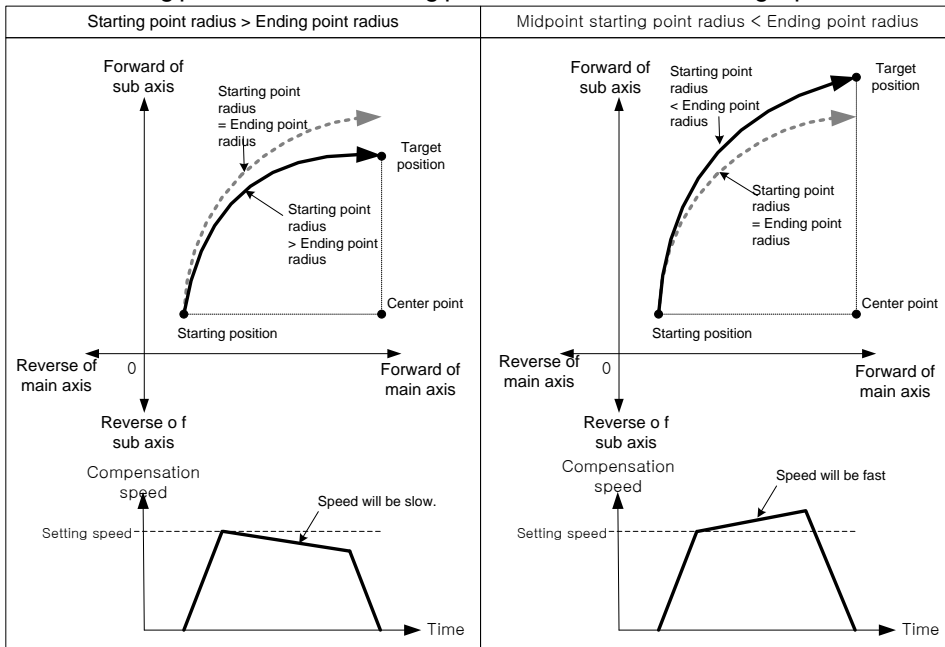

Note

In case of "Starting point radius < Ending point radius", the more operate circular interpolation, the faster. Sometimes exceed 「Speed limit」 of parameter. When operate circular interpolation, in case of starting point radius shorter than ending point radius, lower speed for never exceeding 「Speed limit」.

Can operate no exceed 「Speed limit」, even if it is near to target position.

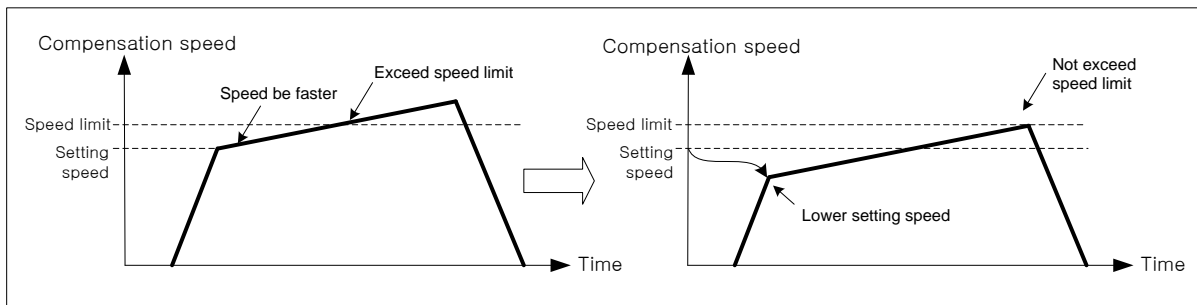

(4) Absolute coordinate function of the number of circular interpolation's rotation

- In case of circular interpolation setting exceed 1 on circular interpolation control of the method of absolute coordinate, designating center point. To set of the number of circular interpolation's rotations operate the number of rotations at the absolute coordinate of first start.
- Even if decelerate and stop, operate origin circular interpolation by restart.
- Condition

In this following case position is changed after deceleration stop command. The number of circular interpolation's rotation is not the number of absolute rotations. It operate by the number of relative rotations.

- After operate positioning command except for current step indirect start (Directing start, Jog operation, Inching operation, Sync. operation, etc),
- After progress position changing command,

[Example] Progress circular interpolation that is the method of absolute, designating center point. And then axis 1 is main axis, axis 2 is sub axis.

- In this case of Starting position (100, 500), Target position (400, 500), Auxiliary position (600, 500), Direction of rotations: CW, operating is as follows:

■ Example of setting XG-PM

- Main axis (axis 1) operation data

Step No.	Control Method	Operation method	Target position [pls]	Operation Speed [pls/s]	Acc. Speed	Dec. Speed	M code	Dwell time	Sub axis setting	Circular interpolation Auxiliary point	Circular Interpolation mode	The number of rotations of Circular interpolation	Helical interpolation
1	Absolute, circular interpolation	Singleness, End	600	1000	No.1	No.1	0	100	Axis 2	600	Midpoint, CW	3	Do not use

- Sub axis (axis 2) operation data

Step No.	Control Method	Operation method	Target position [pls]	Operation Speed [pls/s]	Acc. Speed	Dec. Speed	M code	Dwell time	Sub axis setting	Circular interpolation Auxiliary point	Circular Interpolation mode	The number of rotations of Circular interpolation	Helical interpolation
1	Absolute, Reduction positioning control	Singleness, End	300	0	No.1	No.1	0	0	Axis-undecided	500	Midpoint	0	Do not use

■ Operation pattern

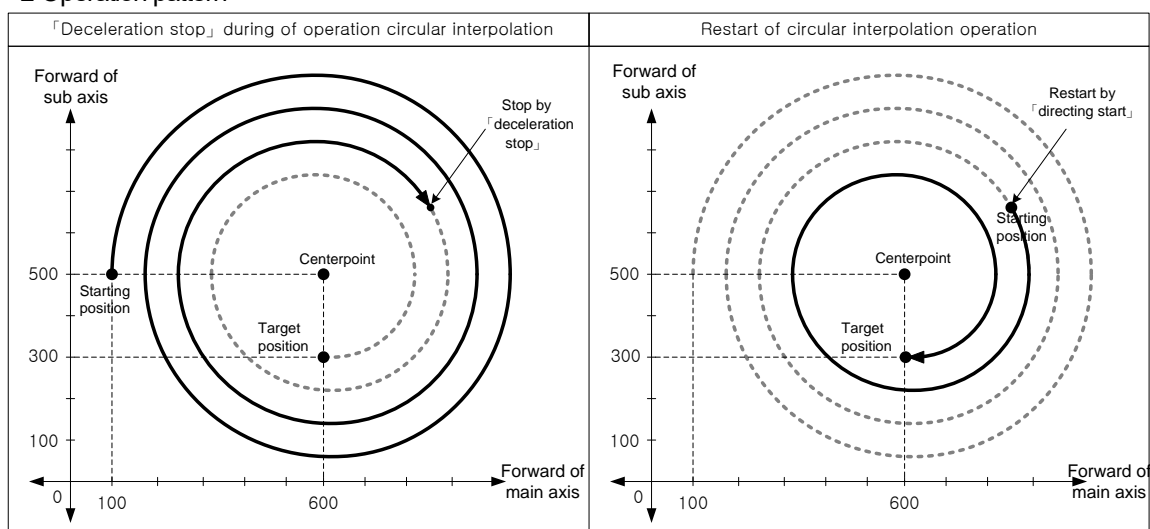

When decelerating in circular interpolation by dec. stop command and restart the same step no., not that executing circular interpolation after circular interpolation being executed 3 times, but that positioning at the goal position after going around 1 time, because 2 times of circular interpolation was executed in former operation.

Chapter 8 Functions

8.2.11 Circular interpolation control with designated radius

After being executed by positioning operation start (「Indirect start」, 「Sync. start」), then it operates along the trace of the circle made by circular interpolation with 2 axes. According to 「The turn no. of circular interpolation」, circular interpolation which is bigger than 360° is available to be executed.

Combination of 2 axes for a circular interpolation is not limited. User may use any 2 axes from axis1 ~ axis4.

(1) Circular interpolation by method of absolute and designating radius (「Absolute, Circular interpolation」)

(a) Start operating at starting position and execute circular interpolation along the trace of the circle which has radius set on circular interpolation auxiliary point of main-axis operating data. Center point of Circular arc depends on the turning direction (CW, CCW) of 「Circular interpolation mode」 and size setting of circular arc (Circular arc<180°, Circular arc>=180°).

Circular interpolation mode	Description
Radius, CW, Arc<180°	Execute circular interpolation in clockwise and the arc is smaller than 180°
Radius, CW, Arc>=180°	Execute circular interpolation in clockwise and the arc is bigger than 180°
Radius, CCW, Arc<180°	Execute circular interpolation in counterclockwise and the arc is smaller than 180° or same.
Radius, CCW, Arc>=180°	Execute circular interpolation in counterclockwise and the arc is bigger than 180° or same.

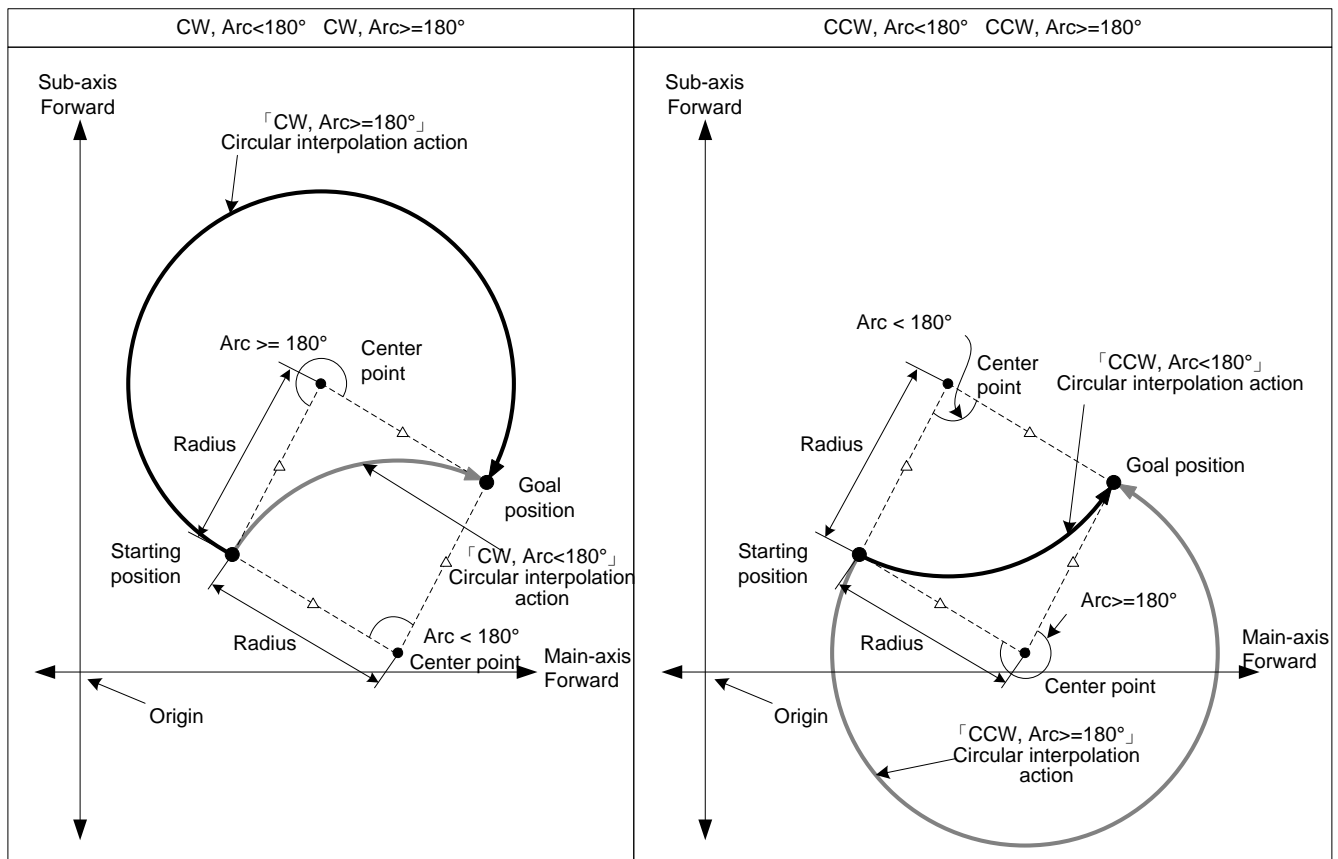

(b) Restrictions

- Circular interpolation with designating radius method may not draw an exact circle that the starting position and ending position are same. If user wants to draw an exact circle, use circular interpolation with center point method.
 - In the cases below, error would arise and circular interpolation may not be executed.
 - 「Sub-axis setting」 error (error code:279)
 - Value of 「Sub-axis setting」 is "Axis-undecided"
 - 「Sub axis setting」 of main axis operating data is the same as main axis no.
 - 「Sub axis setting」 of main axis operating data exceeds the settable axis no. of module now using.
 - Control unit of main or sub axis is set as "degree". (error code : 282(main), 283(sub))
 - Starting position and goal position are same (error code:285)
 - Radius value of circular interpolation of main-axis operating data is smaller than half of the length from starting position to goal position
 - Radius < (R x 0.8) : Error (error code:270)
 - (R x 0.8) <= Radius < R
- : Execute circular interpolation after reset the radius to R. In other words, execute circular interpolation by setting the center of the line from starting position to goal position as center point.

Note

If executing circular interpolation start, 2 axes will operate at the same time. Need user to pay attention.

(1) Auxiliary operations may be used are as follows.

- Speed override, Dec. stop, Emergent stop, Skip operation.

(2) The commands may not be used in circular interpolating operation are as follows.

- Position/Speed switching control, Position override, Continuous operation

(3) The parameter items operating by standards of each axis are as follows.

- Amount of backlash revision in extended parameter items, Software high limit, Software low limit

Chapter 8 Functions

(c) Setting example of Operating data

Items	Main-axis setting	Sub-axis setting	Description
Control Method	Absolute, Circular interpolation	- *1	When executing circular interpolation with absolute coordinates, set 「Absolute, Circular interpolation」 on main
Operating Method	Singular, End	-	Set the method to execute circular interpolation
Goal position[pls]	10000	0	Set the goal position to execute on Main, Sub, Helical axis
Operating speed[pls/s]	1000	-	Use connecting speed designation method for circular interpolation. Set connecting speed on main-axis
Acc. no.	No.1	-	Set no. of acc. time to use in acceleration (no1~4)
Dec. no.	No.2	-	Set no. of dec. time to use in deceleration (no1~4)
M code	0	-	Set it when executing another auxiliary operation synchronizing with circular interpolation
Dwell time	500	-	Set dwell time for outputting positioning complete
Sub-axis setting	Axis2	-	Set an axis to use as sub-axis among the axis available on main-axis operating data.
Auxiliary point	7000	-	Set the radius on main-axis
Circular interpolation	Radius, CW, Arc<180°	-	If use radius designation method, set 「Radius」 on main-axis and set moving direction of arc and size of arc
The No. of Turns	-	-	Set the no. of turns of arc for making a circle bigger than 360°
Helical	Not use	-	When using circular interpolation, set it to 「Not use」

*1 : It means that no need to be set. Whatever value it is, it dose not affect circular interpolation.

Note

(1) Circular interpolation control of Radius designation method is executed on the basis of the items set on operating data. When it is executed, only 「Goal position」 can affect circular interpolation. In other words, whatever value is set as, it does not affect the action and no errors arise.

(2) When setting the circular interpolating auxiliary point (radius) of main-axis, it must be bigger than the half of the length between starting position and goal position. If it is smaller than the half(R) and the value is higher than 80% of R, circular interpolation which has middle point between starting position and goal position as center-point is executed. If it is smaller than the half(R) and the value is lower than 80% of R, error (error code:270) arises and circular interpolation is not executed.

[Example] Axis1 is main-axis and Axis2 is sub-axis. Execute circular interpolation with relative coordinates and designated radius.

- Starting position (1000, 1000), Goal position (9000, 1000), Auxiliary point (5000, 0)

Moving direction of arc : CCW, Size of arc : Arc $\geq 180^\circ$

The action is as follows in the condition above

- Setting example in XG-PM

▪ Main-axis(Axis1) Operating data

Step No.	Control method	Operation Method	Goal position [pls]	Operating speed [pls/s]	Acc. No.	Dec. No.	M Code	Dwell Time	Sub-axis Setting	Auxiliary Point	Circular interpolation mode	The no. of turns	Helical interpolation
1	Absolute, Circular interpolation	Singular, End	8000	1000	No.1	No.1	0	100	Axis2	5000	Radius, CW, Arc <180	0	Not use

▪ Sub-axis(Axis2) Operating data

Step No.	Control method	Operation Method	Goal position [pls]	Operating speed [pls/s]	Acc. No.	Dec. No.	M Code	Dwell Time	Sub-axis Setting	Auxiliary Point	Circular interpolation mode	The no. of turns	Helical interpolation
1	Absolute, single axis position control	Singular, End	8000	1000	No.1	No.1	0	100	Axis2	5000	Radius, CW, Arc <180	0	Not use

- Operation pattern

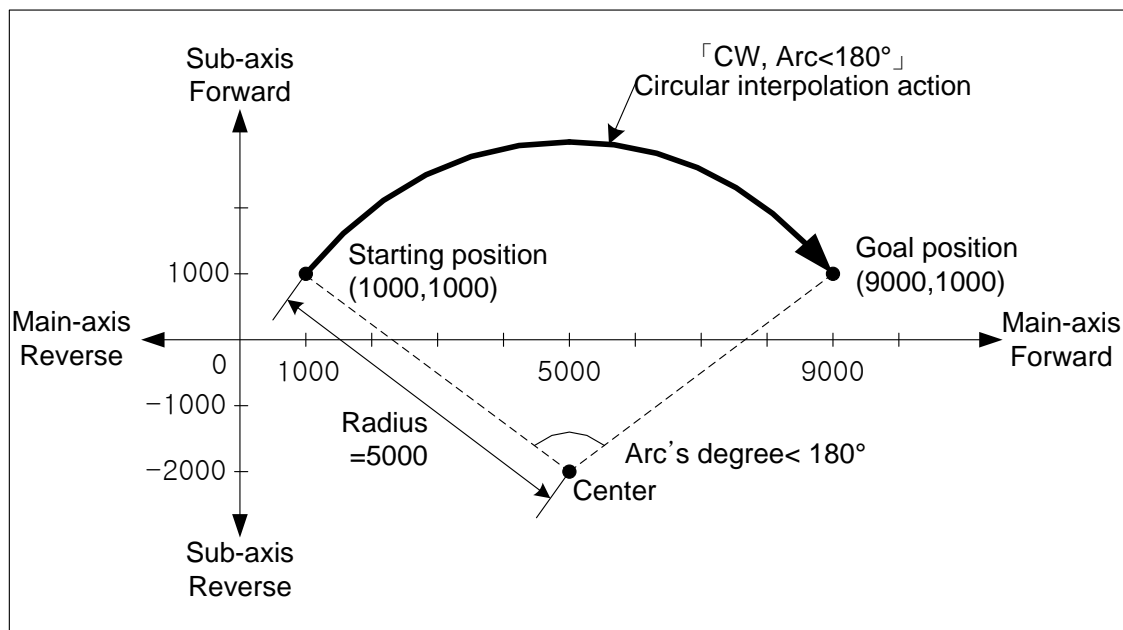

Chapter 8 Functions

(2) Circular interpolation by method of relative and designating radius (「Relative, Circular interpolation」)

- (a) Start operating from starting position and then execute circular interpolation by increment set on goal position along the trace of the circle which has the value set on circular interpolation auxiliary point of main-axis operation data as a radius. Circular arc depends on the moving direction of 「Circular interpolation mode」 (CW, CCW) and setting of arc size (Arc<180°, Arc>=180°)

Circular interpolation mode	Description
Radius, CW, Arc<180°	Execute circular interpolation with center-point of arc which smaller than 180° in direction of CW
Radius, CW, Arc >=180°	Execute circular interpolation with center-point of arc which bigger than 180° in direction of CW
Radius, CCW, Arc<180°	Execute circular interpolation with center-point of arc which smaller than 180° in direction of CCW
Radius, CCW, Arc>=180°	Execute circular interpolation with center-point of arc which bigger than 180° in direction of CWW

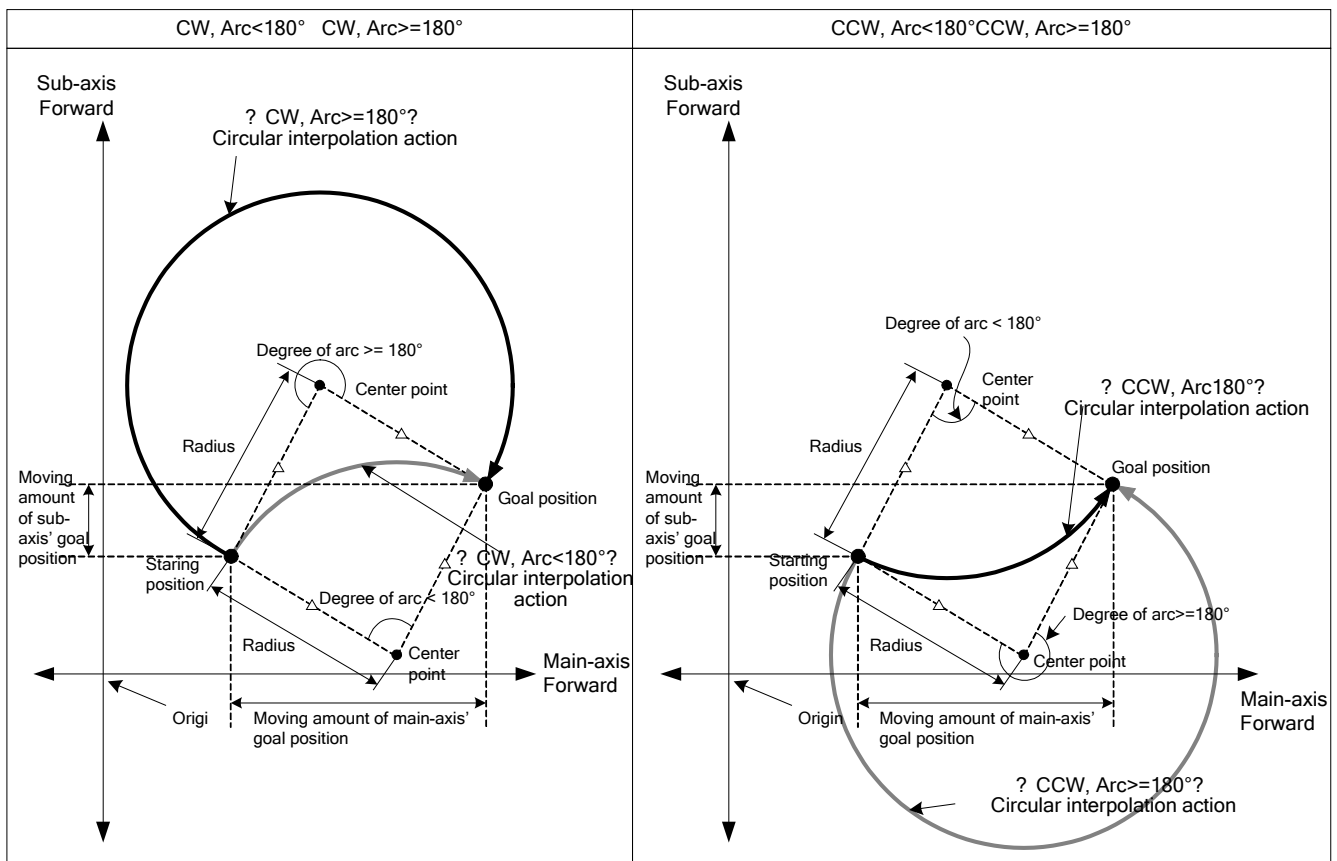

(b) Restrictions

- Circular interpolation with designating radius method may not draw an exact circle that the starting position and ending position are same. If user wants to draw an exact circle, use circular interpolation with center point method.
 - In the cases below, error would arise and circular interpolation may not be executed.
 - 「Sub-axis setting」 error (error code: 279)
 - Value of 「Sub-axis setting」 is “Axis-undecided”
 - 「Sub axis setting」 of main axis operating data is the same as main axis no.
 - 「Sub axis setting」 of main axis operating data exceeds the settable axis no. of module now using.
 - Control unit of main or sub axis is set as “degree”. (error code : 282(main), 283(sub))
 - Starting position and goal position are same (error code: 285)
 - Radius value of circular interpolation of main-axis operating data is smaller than half of the length from starting position to goal position
 - Radius < (R x 0.8) : Error (error code: 270)
 - (R x 0.8) <= Radius < R
- : Execute circular interpolation after reset the radius to R. In other words, execute circular interpolation by setting the center of the line from starting position to goal position as center point.

(c) Setting example of Operating data

Items	Main-axis setting	Sub-axis setting	Description
Control Method	Relative, Circular interpolation	- *1	When executing circular interpolation with absolute coordinates, set 「Relative, Circular interpolation」 on main
Operating Method	Singular, End	-	Set the method to execute circular interpolation
Goal position[pls]	10000	0	Set the goal position to execute on Main, Sub, Helical axis
Operating speed[pls/s]	1000	-	Use connecting speed designation method for circular interpolation. Set connecting speed on main-axis
Acc. no.	No.1	-	Set no. of acc. time to use in acceleration (no1~4)
Dec. no.	No.2	-	Set no. of dec. time to use in deceleration (no1~4)
M code	0	-	Set it when executing another auxiliary operation synchronizing with circular interpolation
Dwell time	500	-	Set dwell time for outputting positioning complete
Sub-axis setting	Axis2	-	Set an axis to use as sub-axis among the axis available on main-axis operating data.
Auxiliary point	7000	-	Set the radius on main-axis
Circular interpolation	Radius, CW, Arc<180°	-	If use middle-point-designation method, set 「Middle-point」 on main-axis
The No. of Turns	-	-	Set the no. of turns of arc for making a circle bigger than 360°
Helical	Not use	-	When using circular interpolation, set it to 「Not use」

- *1 : It means that no need to be set. Whatever value it is, it dose not affect circular interpolation.

Chapter 8 Functions

Note

(1) Circular interpolation control of Radius designation method is executed on the basis of the items set on operating data. When it is executed, only 「Goal position」 can affect circular interpolation. In other words, whatever value is set as, it does not affect the action and no errors arise.

(2) When setting the circular interpolating auxiliary point (radius) of main-axis, it must be bigger than the half of the length between starting position and goal position. If it is smaller than the half(R) and the value is higher than 80% of R, circular interpolation which has middle point between starting position and goal position as center-point is executed. If it is smaller than the half(R) and the value is lower than 80% of R, error (error code:270) arises and circular interpolation is not executed.

[Example] Axis1 is main-axis and Axis2 is sub-axis. Execute circular interpolation with relative coordinates and designated radius.

- Starting position (1000, 1000), Goal position (8000, 0), Auxiliary point (5000, 0)

Moving direction of arc : CCW, Size of arc : Arc $\geq 180^\circ$

The action is as follows in the condition above

- Setting example in XG-PM

- Main-axis(Axis1) Operating data

Step No.	Control method	Operation Method	Goal position [pls]	Operating speed [pls/s]	Acc. No.	Dec. No.	M Code	Dwell Time	Sub-axis Setting	Auxiliary Point	Circular interpolation mode	The no. of turns	Helical interpolation
1	Relative, Circular interpolation	Singular, End	8000	1000	No.1	No.1	0	100	Axis2	5000	Radius, CCW, Arc ≥ 180	0	Not use

- Sub-axis(Axis2) Operating data

Step No.	Control method	Operation Method	Goal position [pls]	Operating speed [pls/s]	Acc. No.	Dec. No.	M Code	Dwell Time	Sub-axis Setting	Auxiliary Point	Circular interpolation mode	The no. of turns	Helical interpolation
1	Absolute, single axis position control	Singular, End	1000	0	No.1	No.1	0	100	Axis2	0	Middle point	0	Not use

- Operation pattern

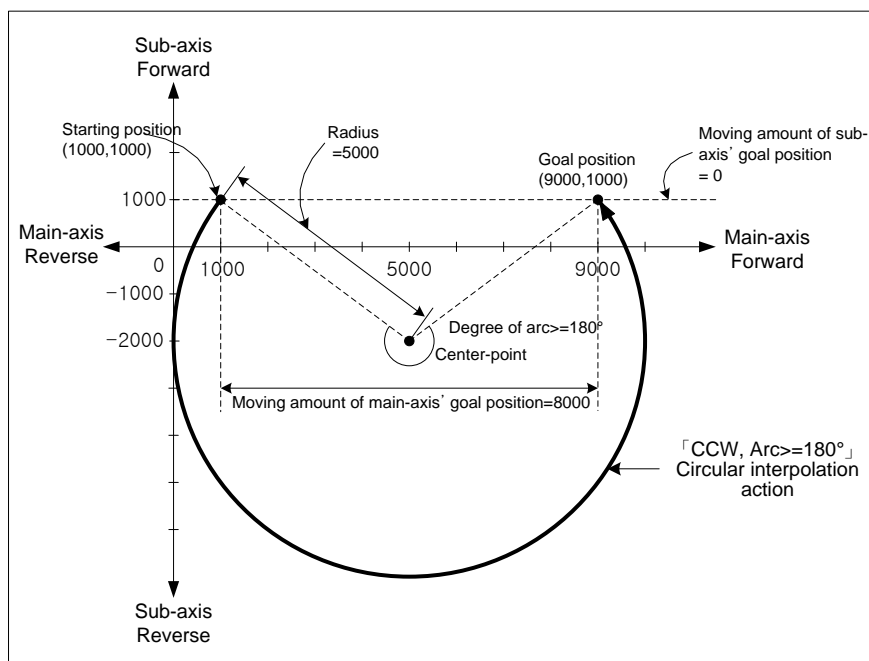

8.2.12 Helical Interpolation Control

After executed by positioning operation start command (Indirect, Synchronous), 2 axes move along the circular arc, an axis execute linear interpolation synchronizing with circular interpolation.

It may execute helical interpolation of bigger scale than 360°

Combinations of axis to use are not limited and 3 axes are used among axis1~axis4.

(1) Characteristics of control

- (a) After setting operating data to circular interpolation, then set a helical interpolation axis on the item "Helical interpolation", the helical interpolation will be executed.
- (b) The direction of circular arc depends on the goal position and the mode of circular interpolation, the direction of helical axis depends on the coordinates setting and the goal position.
 - The case of 「Absolute, Circular interpolation」
 - Starting position < Goal position : Positioning operation in forward direction
 - Starting position > Goal position : Positioning operation in reverse direction
 - The case of 「Relative, Circular interpolation」
 - Positive sign (+) or No sign : Positioning operation in forward direction
 - Negative sign (-) : Positioning operation in reverse direction

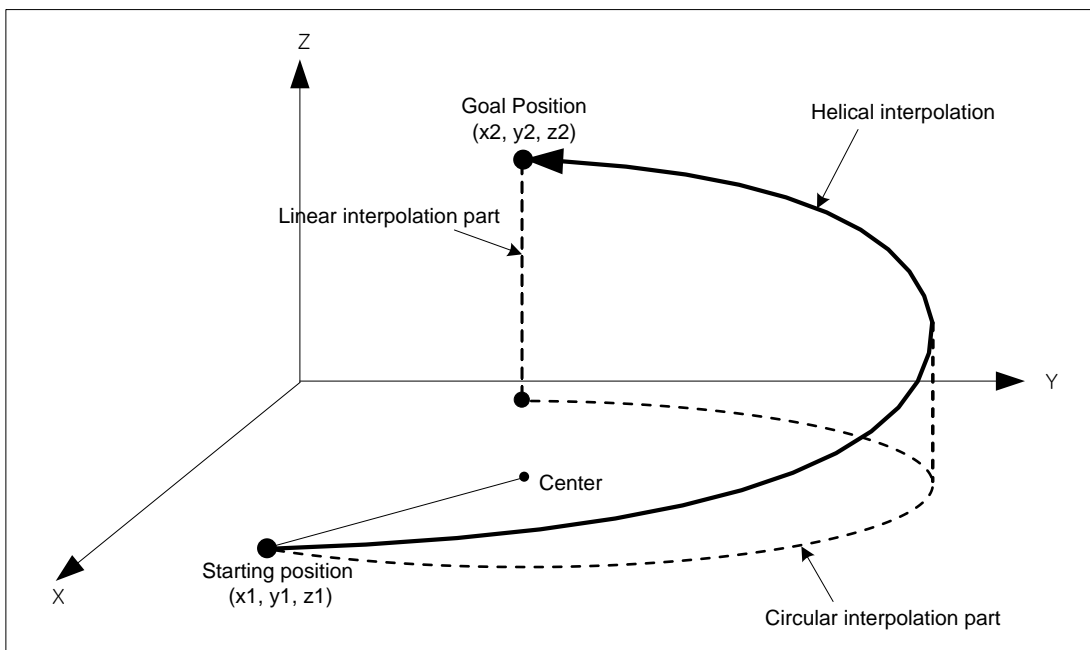

(2) Restrictions

- (a) The restrictions of helical interpolation are same as various kinds of circular interpolation depending on the mode of circular interpolation.
- (b) If user sets 「Helical Interpolation」 to "Not use", it will be same as the action of circular interpolation.
- (c) If user sets the goal position of helical interpolation axis to the same starting position, it will be same as the action of circular interpolation.

Chapter 8 Functions

Note

If executing helical interpolation, 3 axes will operate at the same time. Need user to pay attention.

(1) Auxiliary operations may be used are as follows.

- Speed override, Dec. stop, Emergent stop, Skip operation.

(2) The commands may not be used in circular interpolating operation are as follows.

- Position/Speed switching control, Position override, Continuous operation

(3) The parameter items operating by standards of each axis are as follows.

- Amount of backlash revision in extended parameter items, Software high limit, Software low limit

(3) Example of operation data setting

Items	Main axis(axis1) Setting	Sub axis(axis2) Setting	Helical axis(axis3) setting	Description
Control method	Absolute, Circular interpolation	- *1	- *1	Circular interpolation must be set when executing helical interpolation
Operation method	Singular, End	-	-	Set operation method for helical interpolation
Goal position[pls]	10000	0	10000	Set the goal position on main, sub, helical axis for executing positioning.
Operation speed[pls/s]	1000	-	-	Helical interpolation designates composition speed of circular interpolation part
Acc. no.	No.1	-	-	Set acc. time no. used in acceleration (no.1 ~ no.4)
Dec. no	No.2	-	-	Set dec. time no. used in deceleration (no.1 ~ no.4)
M code	0	-	-	Set it when user needs to synchronize another auxiliary operation with helical interpolation.
Dwell time	500	-	-	Set dwell time(ms) for outputting positioning complete signal
Sub axis setting	Axis2	-	-	Set an axis to be used as sub axis from settable axis on main axis operation data
Auxiliary point of Circular interpolation	5000	5000	-	Set auxiliary data of circular interpolation action
Circular interpolation mode	Middle point	-	-	Set circular interpolation mode to be used in circular action of helical interpolation
No. of turn of circular interpolation	0	-	-	Set the no. of turn of circular arc when user need to execute helical interpolation of bigger degree than 360°
Helical interpolation	Axis3	-	-	Set an axis to be used as helical interpolation axis from settable axis on main axis operation data

- *1 : This item does not need to be set. Whatever it is set as, it dose not affect circular interpolation.

Note

Helical interpolation control is executed on the item basis set on operation data of main axis.

When executing circular interpolation of helical interpolation, only "Goal position", "Auxiliary point of circular interpolation" items of sub axis setting and "Goal position" item of helical axis setting affect helical interpolation. In other words, Whatever the setting value is, it does not affect operation and cause any errors.

[Example] Execute helical interpolation of absolute coordinates, center point designating method and axis1, axis2, axis3 are main, sub, helical axis.

- The action in the case (Starting point (650, 400, 0), Goal position (400, 1200, 350), Auxiliary point (800, 400)) is as follows.
- Setting example of XG-PM
 - Operation data of main axis(axis1)

Step no.	Control method	Operating method	Goal position [pls]	Operating speed [pls/s]	Acc. no.	Dec. no.	M code	Dwell time	Sub axis setting	Auxiliary point of circular interpolation	Circular interpolation mode	No. of turn of circular interpolation	Helical interpolation
1	Absolute, circular interpolation	Singular, End	400	1000	No.1	No.1	0	100	Axis2	800	Middle point, CCW	0	Axis3

- Operation data of sub axis(axis2)

Step no.	Control method	Operating method	Goal position [pls]	Operating speed [pls/s]	Acc. no.	Dec. no.	M code	Dwell time	Sub axis setting	Auxiliary point of circular interpolation	Circular interpolation mode	No. of turn of circular interpolation	Helical interpolation
1	Absolute, single axis position control	Singular, End	1200	0	No.1	No.1	0	100	-	400	Middle point	0	Not use

- Operation data of sub axis(axis2)

Step no.	Control method	Operating method	Goal position [pls]	Operating speed [pls/s]	Acc. no.	Dec. no.	M code	Dwell time	Sub axis setting	Auxiliary point of circular interpolation	Circular interpolation mode	No. of turn of circular interpolation	Helical interpolation
1	Absolute, single axis position control	Singular, End	350	0	No.1	No.1	0	100	-	0	Middle point	0	Not use

- Operating pattern

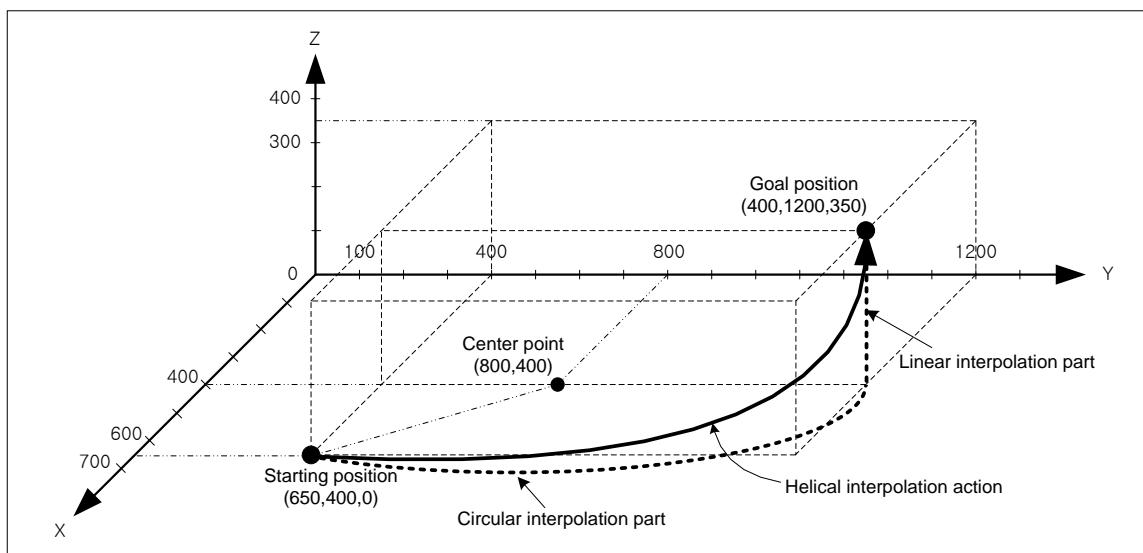

Chapter 8 Functions

8.2.13 Ellipse Interpolation Control

Execute ellipse interpolation at ellipse rate and the moving angle of circular interpolation operating data and ellipse interpolation command.

Combinations of axis to be used in ellipse interpolation control are unlimited and 2 axes from axis1~4 are used.

(1) Characteristics of Control

(a) Ellipse interpolation is set with circular interpolation of center-designated method and the rate and size of ellipse is set with auxiliary data of "ellipse interpolation command"

Auxiliary data	Setting value	Description
Ratio of ellipse (%)	0 ~ 65535	Set the ratio of horizontal axis and vertical axis with the ratio to the circle (1 = 0.01%)
Size(Degree) of ellipse	0 ~ 65535	Set the degree of ellipse's movement (1 = 0.1°)

(b) Moving direction of ellipse is decided by the direction set on "circular interpolation mode" of operation data.

- 「Center point, CW」 - Execute ellipse interpolation in clockwise.
- 「Center point, CCW」 - Execute ellipse interpolation in counterclockwise.

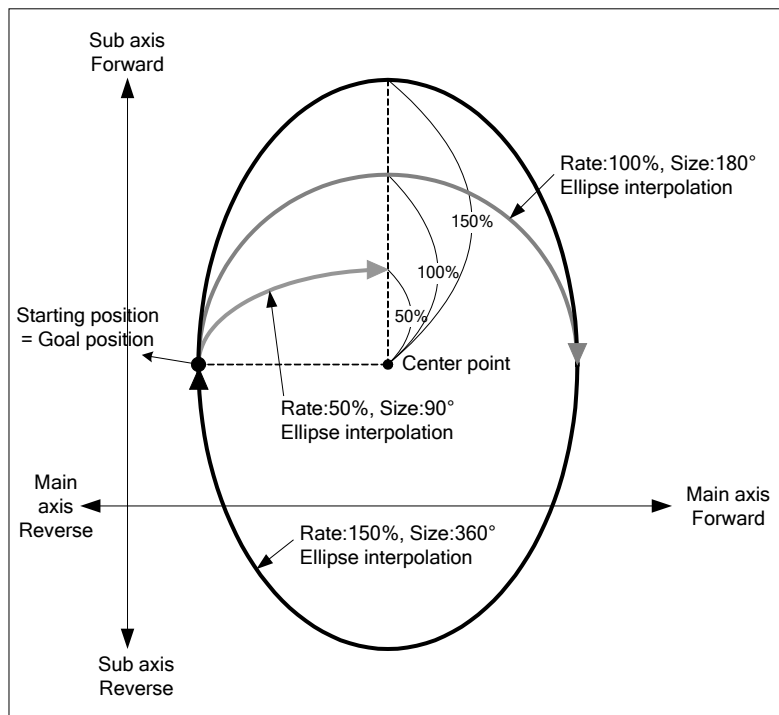

(c) Starting position and goal position must be same when executing ellipse interpolation.

(d) When executing ellipse interpolation, the radius changes continuously and composing speed also changes depending on the ratio of ellipse. When the ratio of ellipse is bigger than 100%, operating speed of sub axis and composing speed get faster. So it calls user's attention. Sub axis of ellipse interpolation is not limited by "speed limit", so user must set operating speed below limit.

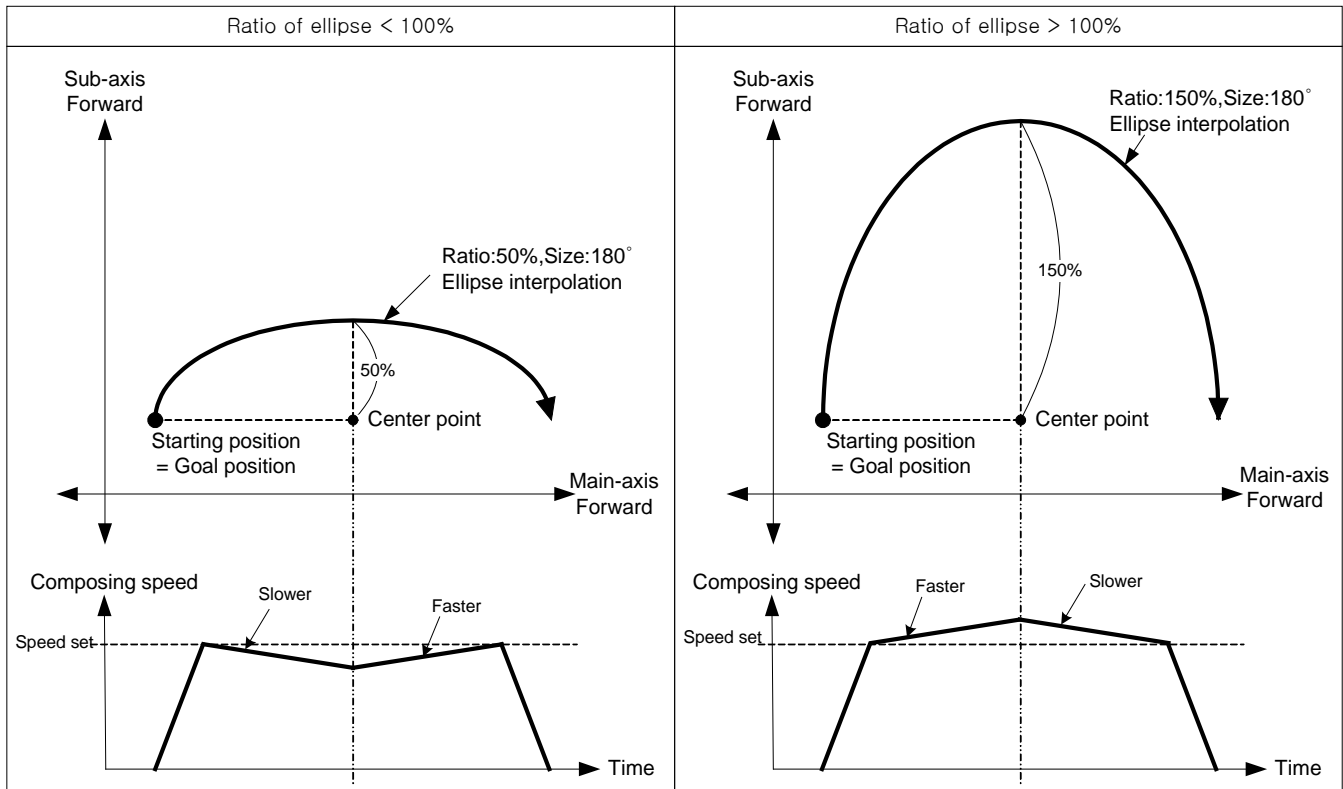

(2) Restrictions

(a) Ellipse interpolation may not be executed in the case below.

- 「Sub-axis setting」 Error (error code : 547)
 - The value of sub-axis setting of main axis operating data is "Axis-undecided".
 - The value of sub-axis setting of main axis operating data is set equally to the no. of main-axis.
 - The value of sub-axis setting of main axis operating data is set wrongly. (Exceeding settable axis no.)
 - An axis of helical interpolation is set.
- Control unit of main or sub axis is set as "degree". (error code : 551(main), 552(sub))
- The center point designated as auxiliary point is the same as starting position or goal position. (error code : 553)
- The radius of circular arc that calculated exceeds 2147483647pls. (error code : 554)
- The operating method is "continuous" or "go on". (error code : 556)

If user executes ellipse interpolation, End operation must be set before use.
- Starting position and Goal position are different. (error code : 558)
- Size of circular arc (Moving degree) is 0. (error code : 559)

Chapter 8 Functions

Note

Need user to heed the synchronous operation of 2 axes in ellipse interpolation start.

1. Auxiliary operations available are as follows.
 - Speed override, Dec. stop, Emergent stop, Skip operation
2. The commands unavailable in ellipse interpolating operation are as follows.
 - Position/Speed switching control, Position override, Continuous operation
3. Parameter items of each axis on setting value basis are as follows.
 - Backlash revision of extended parameter, Software high limit, Software low limit

(3) Setting example of operation data

Items	Main-axis setting	Sub-axis setting	Description
Control Method	Absolute, Circular interpolation	- *1	Set circular interpolation when executing ellipse interpolation
Operating Method	Singular, End	-	"End" must be set in ellipse interpolation
Goal position[pls]	10000	0	Set the goal position to execute on Main, Sub, Helical axis
Operating speed[pls/s]	1000	-	Designate composing speed for circular interpolation part in ellipse interpolation
Acc. no.	No.1	-	Set no. of acc. time to use in acceleration (no1~4)
Dec. no.	No.2	-	Set no. of dec. time to use in deceleration (no1~4)
M code	0	-	Set it when executing another auxiliary operation synchronizing with ellipse interpolation
Dwell time	500	-	Set dwell time for outputting positioning complete
Sub-axis setting	Axis2	-	Set an axis to use as sub-axis among the axis available on main-axis operating data.
Auxiliary point	5000	5000	Set the center point of ellipse
Circular interpolation	Center point, CW	-	Must be set center point when using ellipse interpolation
The No. of Turns	-	-	The no. of turn is not operated in ellipse interpolation
Helical	Not use	-	Set axis of helical interpolation as "Not Use" in ellipse interpolation

*1 : It means that no need to be set. Whatever value it is, it dose not affect circular interpolation.

Note

Ellipse interpolation control is executed by the standard set on operating data of main-axis.

When executing ellipse interpolation, only 「Goal position」 and 「Auxiliary point of circular interpolation」 affect the operation of ellipse interpolation. In other words, whatever value is set to, it does not affect operation and no errors arise.

[Example] Execute ellipse interpolation with 20% of ellipse ratio, 360° of movement degree and relative coordinates

- Starting position (100, 100),
Setting of goal position : (0, 0)
Setting of auxiliary point : (500, 200)
Direction of operation : CW

■ Example setting in XG-PM

▪ Operation data of Main-axis(axis1)

Step no.	Control method	Operating method	Goal position [pls]	Operating speed [pls/s]	Acc. No.	Dec. No.	M code	Dwell Time	Setting Sub axis	Auxiliary point of circular interpolation	Circular interpolation mode	The no. of turns	Helical interpolation
1	Relative, circular interpolation	Singular, End	0	1000	No.1	No.1	0	100	Axis2	800	Center,CW	0	Not use

▪ Operation data of Sub-axis(axis2)

Step no.	Control method	Operating method	Goal position [pls]	Operating speed [pls/s]	Acc. No.	Dec. No.	M code	Dwell Time	Setting Sub axis	Auxiliary point of circular interpolation	Circular interpolation mode	The no. of turns	Helical interpolation
1	Absolute, Single axis position control	Singular, End	0	0	No.1	No.1	0	0	Undecided	400	Middle point	0	Not use

■ Operating data

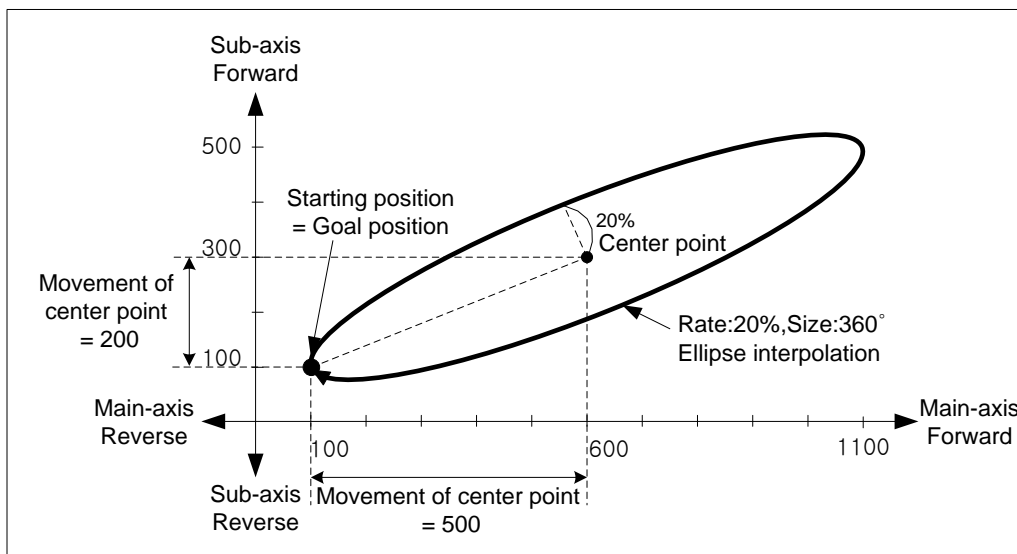
**Note**

- (1) If the degree of ellipse is not 360°, the goal position and actual position after stop operating are not same.
- (2) If the ratio of ellipse is 0%, the trace of ellipse interpolation is shown as straight line. Ratio of ellipse need to be set to above 0.

Chapter 8 Functions

8.2.14 Speed/Position Switching Control

The setting axis by positioning start carries out the speed control and is switched from speed control to position control when speed/position switching signal is entered to the positioning module inside or outside, and then carries out the positioning as much as goal transfer amount.

(1) Characteristics of Control

- Set control method of operating data as "Single axis speed control" and executing positioning with 「Speed/Position Switching」 in speed control operation.
- Direction of movement depends on the sign of value.
 - Forward : The position value is Positive(+)
 - Reverse : The position value is Negative(-)
- For using 「External speed/position switching control」, "External speed/position switching control" must be set as '1 : Allowed'

Item	Setting value	Description
External speed/position switching control	0 : Not allowed	External speed/position switching control signal is ignored and it does not affect operation
	1 : Allowed	External speed/position switching control signal is operated

- In speed/position switching control, the value of coordinates has no affection. In other words, actions of "Absolute, Single axis speed control" and "Relative, Single axis speed control" are same.

(2) Operation timing

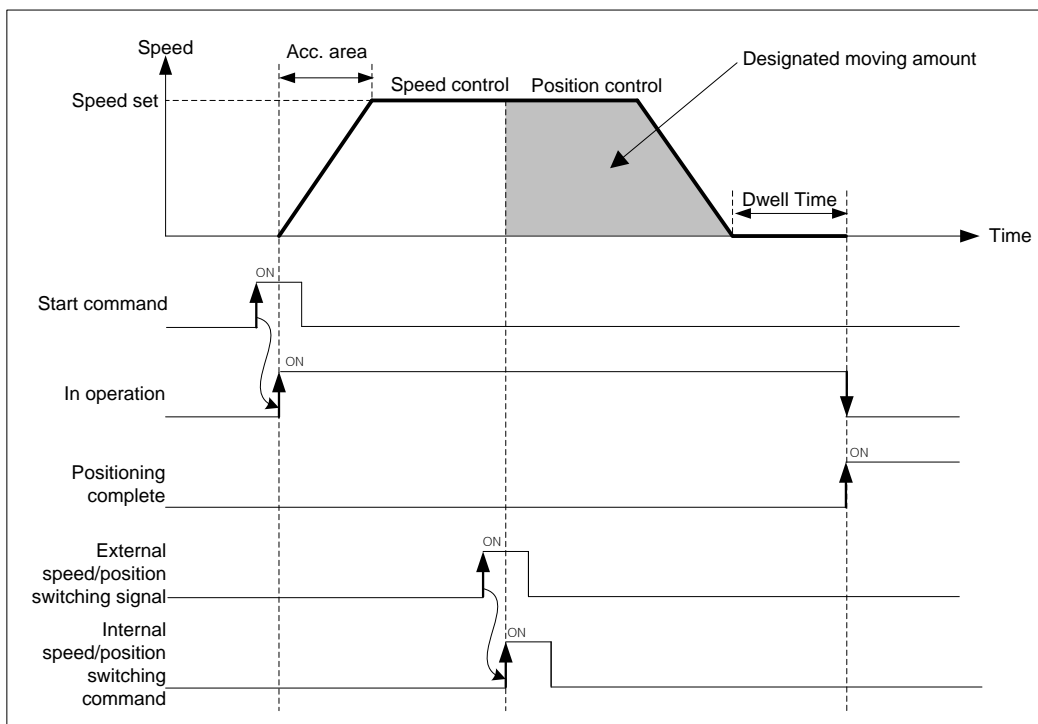

(3) Restrictions

- (a) Operation pattern of speed control has to be set as "End" or "Go on". If "Continuous" is set as, error (error code:236) arises and speed control may not be executed.
- (b) If the value of goal position is 0, speed/position switching command may not be executed. In this case, it continues to operate with speed control.

(4) Setting example of operation data

Items	Setting value	Description
Control method	Absolute, Single axis speed control	When executing speed/position switching control, set single axis speed control
Operating method	Singular, End	When executing speed/position switching control, set "end" or "continuous"
Goal position [pls]	10000	After inputting speed/position switching control, set moving amount to position.
Operating speed [pls/s]	1000	Set the operating speed of speed/position switching control
Acc. no.	No1	Set acc. no. used in acceleration (no.1~4)
Dec. no.	No.2	Set dec. no. used in deceleration (no.1~4)
M code	0	Set it when user needs to execute another auxiliary work synchronizing with speed/position switching control
Dwell time	500	Set dwell time(ms) between switching command's inputting and positioning completion's outputting

Chapter 8 Functions

8.2.15 Position specified Speed/Position Switching Control

The setting axis by positioning start carries out the speed control and is switched from speed control to position control when speed/position switching signal is entered to the positioning module, and then carries out the positioning by transfer amount.

(1) Characteristics of Control

- Set control method of operating data as "Single axis speed control" and execute 「Speed/Position Switching」 in speed control operation.
- Set the speed/position switching coordinate

Item	Setting value	Description
speed/position switching coordinate	0 : Incremental	Operates as relative coordinates from the position at command executed.
	1 : Absolute	Operates as absolute coordinates regardless of executed position..

- In speed/position switching control, the value of coordinates has no affection. In other words, actions of "Absolute, single axis speed control" and "Relative, single axis speed control" are same.
- In Position specified speed/position control, a target position set in the operation data or direct start is ignored and it moves according to target position operand of 「Position specified speed/position switching control」 command

(2) Operation timing

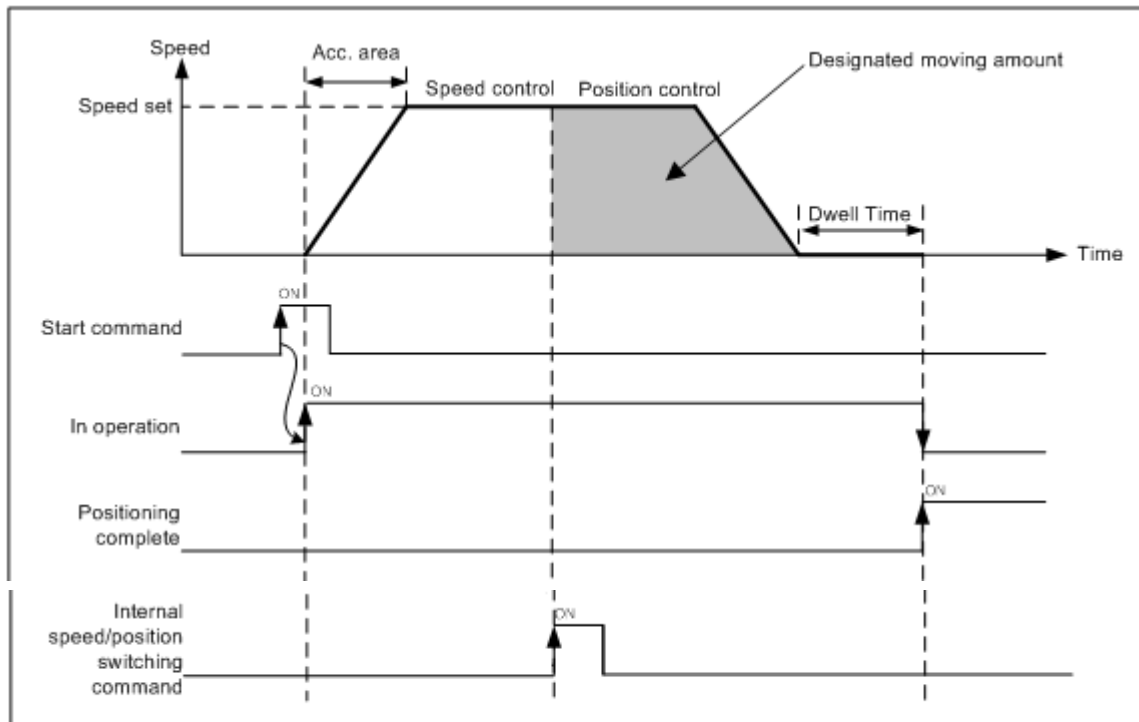

(3) Restrictions

- (a) Operation pattern of speed control has to be set as "End" or "Go on". If "Continuous" is set as, error (error code:236) arises and speed control may not be executed.
- (b) If the value of goal position is 0, position specified speed/position switching command may not be executed. In this case, it continues to operate with speed control.

(4) Setting example of operation data

Items	Setting value	Description
Control method	Absolute, Single axis speed control	When executing speed/position switching control, set single axis speed control
Operating method	Singular, End	When executing speed/position switching control, set "end" or "continuous"
Goal position [pls]	10000	After inputting speed/position switching control, set moving amount to position.
Operating speed [pls/s]	1000	Set the operating speed of speed/position switching control
Acc. no.	No1	Set acc. no. used in acceleration (no.1~4)
Dec. no.	No.2	Set dec. no. used in deceleration (no.1~4)
M code	0	Set it when user needs to execute another auxiliary work synchronizing with speed/position switching control
Dwell time	500	Set dwell time(ms) between switching command's inputting and positioning completion's outputting

Chapter 8 Functions

8.2.16 Position/Speed Switching Control

The setting axis by positioning start carries out the position control and is switched from position control to speed control when position/speed switching signal is entered to the positioning module inside, and then it stops by deceleration stop or SKIP operation or continues next operation.

(1) Characteristics of Control

- (a) Set control method of operating data as "Single axis position control" and user may change position control to speed control with 「Speed/Position Switching」
- (b) Direction of movement depends on the sign of value and coordinates
 - 「Absolute, Single axis position control」
 - Starting position < Goal position : Positioning in forward direction
 - Starting position > Goal position : Positioning in reverse direction
 - 「Relative, Single axis position control」
 - The value of goal position has positive sign (+) : Positioning in forward direction
 - The value of goal position has negative sign (-) : Positioning in reverse direction

(2) Operating timing

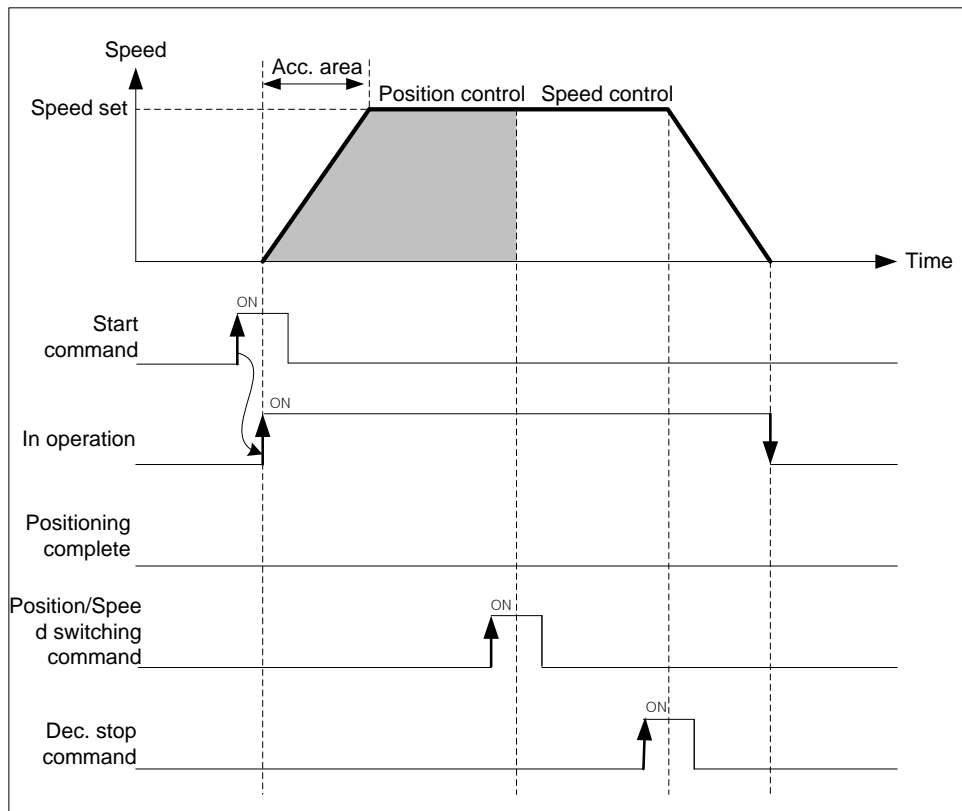

(3) Restrictions

- (a) Position/speed switching command is not inputted before positioning to the goal position, it stops by deceleration and finishes the positioning.
- (b) After position/speed switching, software high/low limit check depends on "Soft high/low limit in speed control" of extended parameter.

Items	Setting value	Description
Soft high/low in speed control	0 : Not detect	Not to execute checking for software high/low limit in speed control
	1 : Detect	Execute checking for software high/low limit in speed control

(4) Setting example of operation data

Items	Setting value	Description
Control method	Absolute, Single axis speed control	When executing position/speed switching control, set single axis speed control
Operating method	Singular, End	Set operating method for position control
Goal position [pls]	10000	Set the value of goal position for position control
Operating speed [pls/s]	1000	Set the operating speed of position/speed switching control
Acc. no.	No.1	Set acc. no. used in acceleration (no.1~4)
Dec. no.	No.2	Set dec. no. used in deceleration (no.1~4)
M code	0	Set it when user needs to execute another auxiliary work synchronizing with speed/position switching control
Dwell time	500	When it is executed with position control and without position/speed switching command, set dwell time between positioning and complete signal's outputting.

Chapter 8 Functions

8.2.17 Start of Positioning

In case of stop in action of dynamic positioning, can positioning by restart. Three Starting types are general start, Simultaneous start, point operation. Operating signal is have to "OFF", when it start.

(1) Direct start

(a) Do not use operating data, directly input positioning data by auxiliary data and perform positioning control.

(b) Setting auxiliary data of direct start.

Setting item	Contents
Target position	Set target position of control.
Operating speed	Set operating speed of control.
Dwell time	Set dwell time (ms) that it is from positioning to outputting signal of positioning. (0~65535)
M code	Set for performing auxiliary action which is depending on set control.(0~65535)
Acceleration time No.	Set acceleration time number for acceleration. (No.1 ~ No.4)
Reduction time No.	Set reduction time number for reduction. (No.1 ~ No.4)
Coordinate	Set coordinate about target position of set control.(absolute, relative)
Control method	When command of converting position/speed is not inputted and only operated by positioning control, set dwell time (ms) that it is from positioning to outputting signal of positioning. (0:Positioning, 1:Speed control, 2:Feed control)

Note

Direct start only can use when it is shortened operation. In case that Interpolation operation, use indirect starts.

(2) Indirect Start

(a) Start control of positioning by designating step number of operation data which was saved in positioning module.

(b) Setting auxiliary data of indirect start

Setting item	Contents
Operation step	Set step number of operation data what you need operating.(0 or 1 ~ 400)

Note

Set 'O' operation step of Indirect start and carry out command of indirect start. And then start operation data which was saved in step number.

(3) Simultaneous start

- (a) According to axis information and setting step, Simultaneous start positioning operation data of axis 2 ~ axis 4.
 (b) When Input stop command, only it decelerates and stops on the corresponding axis. In case of Simultaneous start setting step number is current operating step number. Input start command, and then according to relative coordinate and absolute coordinate, operate positioning.

(c) Condition

In these cases can not operate all of the axes which were set simultaneous start by error.

- When occurred error in over an axis among setting axes of simultaneous start. (Output error code in its axis.)
- When command axis of simultaneous start was wrong. (Error code : 296)
 - Only set command axis (Set over 2 axes is necessary.)
 - In case of exceeding number of possible setting axis of current using module among the possible setting axes

[Example] Set Simultaneous start of axis 1, axis 2, axis 3 is as follows;

- Current position of axis 1: 0, Operation step: 1
 Current position of axis 2: 0, Operation step: 3
 Current position of axis 3: 0, Operation step: 10

■ Example of setting XG-PM

- Operation data of axis 1

Step No.	Control method	Operation method	Target position [pls]	Operation speed [pls/s]	Acceleration No.	Deceleration No.	M code	Dwell time
1	Absolute, Shorten position control	Single, Continuous	1000	1000	1	1	0	0
2	Absolute, Shorten position control	Single, End	1800	800	1	1	0	100

- Operation data of axis 2

Step No.	Control method	Operation method	Target position [pls]	Operation speed [pls/s]	Acceleration No.	Deceleration No.	M code	Dwell time
3	Absolute, Shorten position control	Single, End	900	500	2	2	0	0

- Operation data of axis 3

Step No.	Control method	Operation method	Target position [pls]	Operation speed [pls/s]	Acceleration No.	Deceleration No.	M code	Dwell time
10	Absolute, Shorten speed control	Single, End	1000	300	3	3	0	100

■ Operation pattern

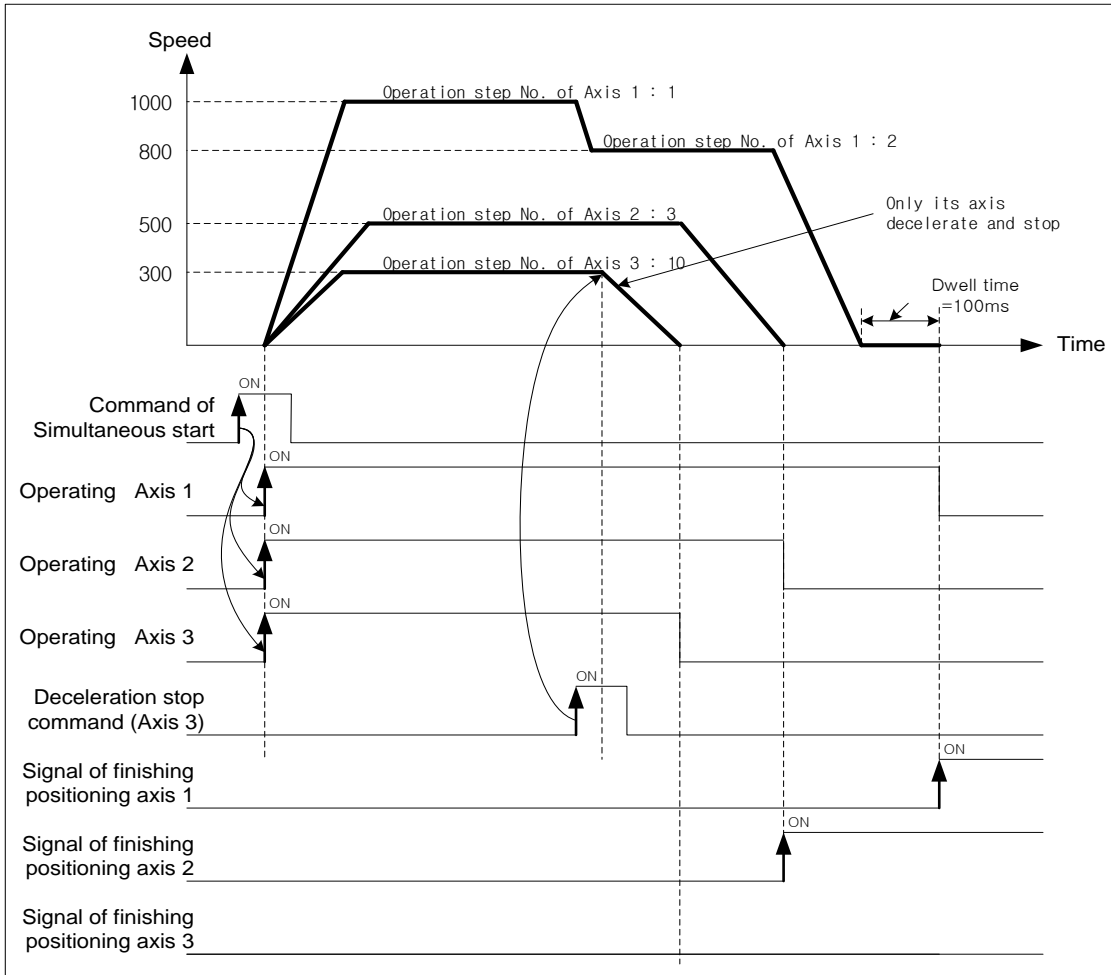

(4) Point operation

- (a) Point maneuvering is a positioning drive also called ptp drive. Which processes the sequential data of user defined steps in order
- (b) It can be appointed 20 steps by point operation.
- (c) Start point maneuvers as much as the number of set points from setting step (point1), irrespective of end, continue, automatic operation mode.

[Example] Point operation of axis 1 is as follows;

- The number of point operation: 4
Point operation step No. : 1, 2, 10, 20
Current position of Axis 1 : 0
- Example of setting XG-PM

Step No.	Control method	Operation method	Target position [pls]	Operation speed [pls/s]	Acceleration No.	Deceleration No.	M code	Dwell time
1	Absolute, Shorten position control	Singleness, End	1000	1000	1	1	0	20
2	Absolute, Shorten position control	Singleness, End	3000	2000	1	1	0	20
10	Absolute, Shorten position control	Singleness, Keep	6000	3000	1	1	0	20
11	Absolute, Shorten position control	Singleness, Keep	10000	4000	1	1	0	20
12	Absolute, Shorten position control	Singleness, Keep	15000	5000	1	1	0	20
13	Absolute, Shorten position control	Singleness, End	25000	6000	1	1	0	20
20	Absolute, Shorten position control	Singleness, Continue	45000	7000	1	1	0	0
21	Absolute, Shorten position control	Singleness, continue	75000	8000	1	1	0	0
22	Absolute, Shorten position control	Singleness, End	0	9000	1	1	0	0

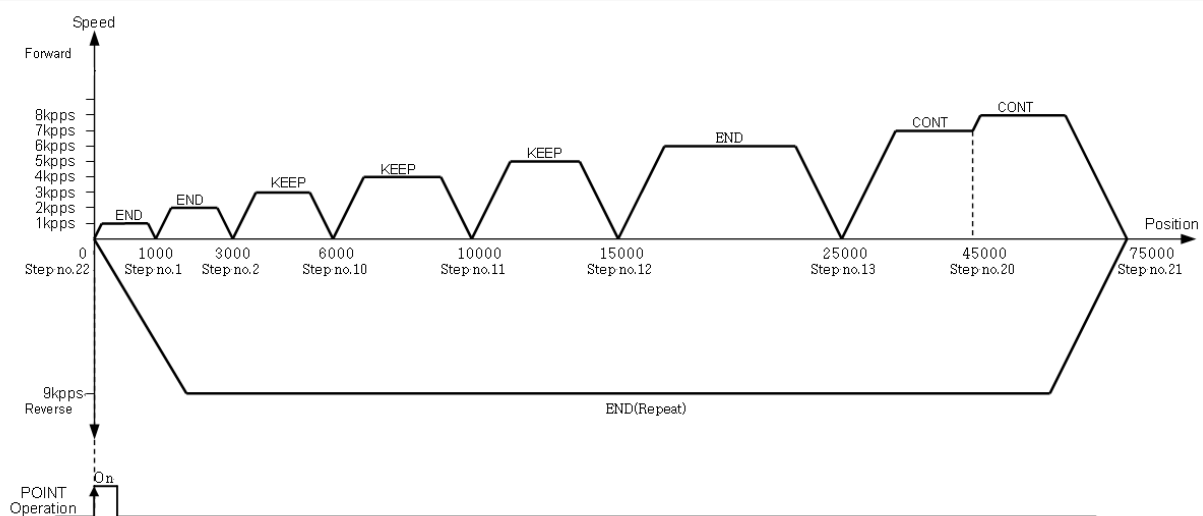

Chapter 8 Functions

8.2.18 Positioning stop

Here describes factor which are stop axis during operation.

(1) Stop command and Stop factor

Command & Stop factor of stop positioning operating is as follows;

- (a) It will stop, when stop command is "On" or there are some stop factors at each axis. But, interpolation control (linear interpolation, Circular interpolation, helical interpolation, elliptic interpolation)

In case of there is stop command or stop factor on main axis, operation axes of interpolation control will stop.

Status Stop factor		Positioning ^{*1}	Homing ^{*2}	Jog Operation	Speed synchronous Cam control	Status of Axis after stop	M code On Status of signal
Parameter setting ^{*3}	Exceed soft high-limit	Prompt stop	No Detection	Prompt stop ^{*5}		Error (Error501)	No change
	Exceed soft low-limit	Prompt stop	No Detection	Prompt stop		Error (Error502)	No change
Sequence program ^{*4}	Deceleration stop command	Deceleration stop	Deceleration stop	Error 322 (Keep operation)	Deceleration stop	Stop On	No change
	Emergency stop command	Sudden stop				Error (Error481)	"Off"
External signal	External high-limit "On"	Sudden stop		When operate to forward, sudden stop	Sudden stop	Error (Error492)	No change
	External low-limit "On"	Sudden stop		When operate to reverse, sudden stop	Sudden stop	Error (Error493)	No change
	External emergency stop "On" ^{*8}	Sudden stop				Error (Error491) prohibition output	"Off"
	External stop "On" ^{*9}	Deceleration stop	Deceleration stop	Error322 (Keep operation)	Deceleration stop	Stop "On"	No change
XG-PM Software	Deceleration stop command	Deceleration stop	Deceleration stop	Error322 (Keep operation)	Deceleration stop	Stop "On"	No change
	Emergency stop command	Sudden stop				Stop "On"	"Off"

Note

*1 : Positioning means position control, speed control, interpolation control, speed/position switching control, position/speed switching control, position/torque control by positioning data.

*2 : When complete homing, approximate origin and HOME signal do not effect to positioning control.

*3 : Only work while software high/low limit on the speed control of expansion parameter at the speed control operation mode is set "1:detection"

*4 : Sequence program means XGT program type.

*5 : Output speed become "0", when it has factor of stop.

*6 : Speed goes to "0" while the deceleration stop time of deceleration stop command support data decelerates as a set time.

*7 : Speed goes to "0" decelerate by set time as 「sudden stop, deceleration」 of parameter.

*8 : When the 「select external emergency stop/ deceleration」 of expansion parameter is "0: emergency stop", it is available.

*9 : When 「select external emergency stop/ deceleration stop」 of expansion parameter is "1: deceleration stop", it is available.

(2) Deceleration Stop

- (a) If meet emergency stop while operate indirect start, direct start, simultaneous start, start operation, homing operation, inching operation, it will sudden stop.
- (b) Deceleration stop command not different at these sections: acceleration section, constant section, deceleration section.
- (c) If it is decelerated and stopped by deceleration stop command, will not be completed positioning operation as set target position. And...
- No signal for completely positioning
 - M code signal cannot be "On" during "After" mode of "M code" mode.
- (d) If it receives order for indirect start command (step No. = current step No.) while it is stop,
- Positioning of absolute coordinate method: Operate amount of the position reminder which it isn't outputted on the current operation step.
 - Positioning of relative coordinate method: Operate as set movement at the target position.
- (e) There are two type of deceleration stop: Internal/external deceleration stop.
- Internal deceleration stop command
It decelerate and stop by XG-PM and 「deceleration stop」 command of sequence program as set support data.
 - External deceleration stop signal
In case of input signal of external emergency stop/deceleration stop to be "On", it will be decelerated and stopped by set deceleration time in current positioning operation.
Have to set item of "select external emergency stop/deceleration stop" of expansion parameter for using input signal of external emergency stop/deceleration stop as external deceleration stop command.

Item	Setting value	Contents
Select external emergency stop/ deceleration stop	0: Emergency stop	Use as "emergency stop" signal when input external signal.
	1: Deceleration stop	Use as "deceleration stop" signal when input external signal.

(f) Condition

- When command internal deceleration stop
The value of deceleration time can bigger than set value of deceleration time by auxiliary data.
- If deceleration stop command is inputted while operate Jog, error (error code: 322) will be made. Use "Stop Jog" command for Jog operation stop.

Chapter 8 Functions

(g) Movement Timing

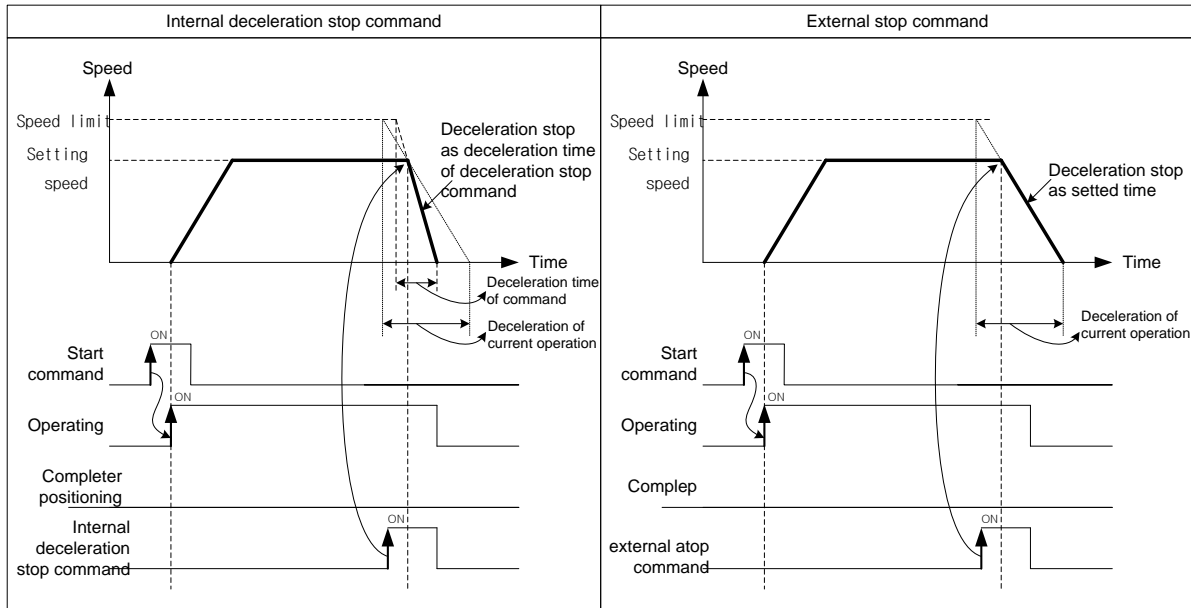

- If the deceleration distance is longer than distance to target position when input deceleration stop command during positioning control operation, it will be stopped at the target position.

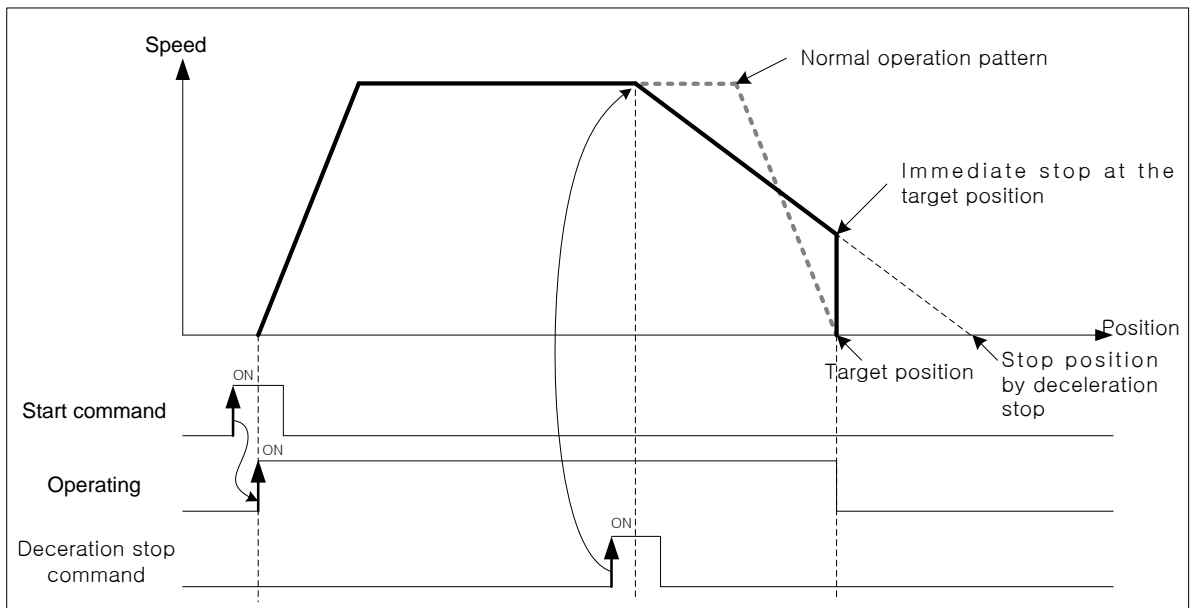

(3) Emergency Stop

- (a) It will be decelerated, stopped and occurred error as set time in 「deceleration time when it is suddenly stopped」 during indirect start, direct start, start at the same time, synch. operation, homing operation, jog operation, inching operation, when it be emergency stopped during operation.
- (b) In case of internal emergency stop, error 481 will occur and in case of external emergency stop, error 491 will occur.
- (c) M code signal will be “Off” after Emergency stop.
- (d) There are two type of Emergency stop: External emergency stop and Internal emergency stop.

- Internal emergency stop command

To be decelerated and stopped by 「emergency stop」 command of XG-PM & Sequence program as set time in 「deceleration time when it is suddenly stopped」, and error will be occurred.

- External emergency stop signal

In case of inputting signal of external emergency stop/ deceleration stop to be “On”, it will be decelerated, stopped and error will be occurred as set time in 「deceleration time when it is suddenly stopped」 of basic parameter.

Have to set “select external emergency stop/deceleration stop” of expansion parameter for using signal of inputting external emergency stop/deceleration stop as “external emergency stop command”

Item	Setting value	Contents
Select external emergency stop/ deceleration stop	0 : Emergency stop	Use as “emergency stop” signal when input external signal
	1 : Deceleration stop	Use as “deceleration stop” signal when input external signal

- Setting related parameter (Basic parameter)

Item	Setting value	Contents
When sudden stop, deceleration time	0 ~ 2147483647 [ms]	Set deceleration time for using when detect hardware high/low limit signal. Deceleration time express needed time for deceleration as bias speed at speed limit, when suddenly stop.

(e) Motion timing

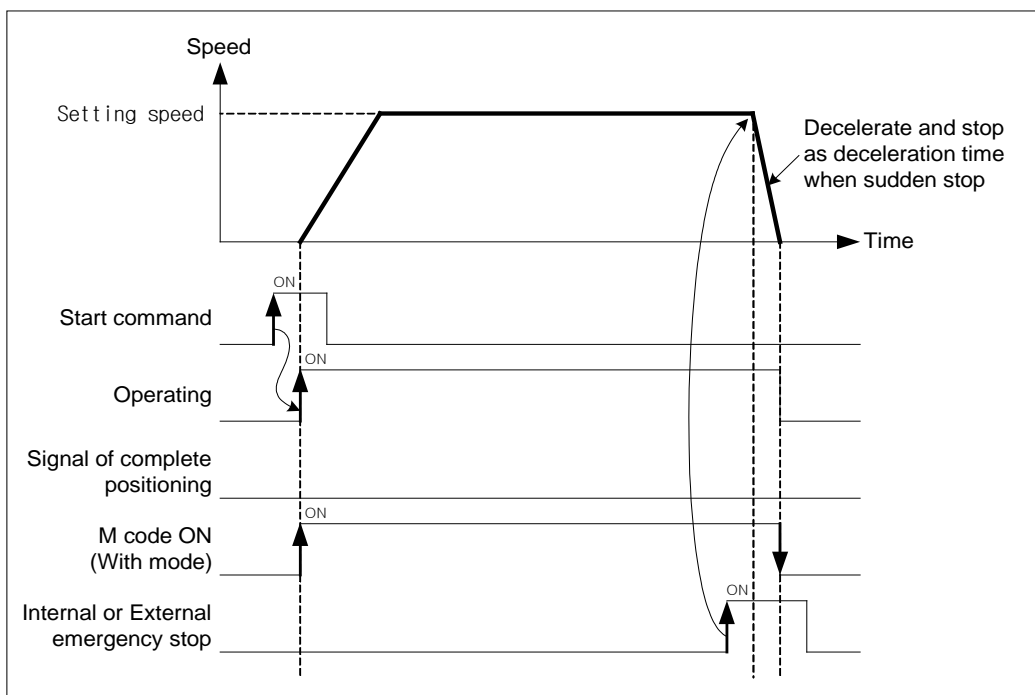

Chapter 8 Functions

(4) Stop hardware by high/low limit

- When positioning control, if the signal of hardware high/low limit is inputted, then stop positioning control and it will be decelerated and stopped as set time at 「deceleration time when it is suddenly stopped」, and error will be occurred.
- In case of external input stroke high limit error, error 492 will occur and in case of external input stroke low limit error, error 493 will occur.

■ Setting related parameter (basic parameter)

Item	Setting value	Content
When sudden stop, deceleration time	0 ~ 2147483647 [ms]	Set deceleration time for using when detect hardware high/low limit signal. Deceleration time express needed time for deceleration as bias speed at speed limit, when suddenly stop.

(c) Motion timing

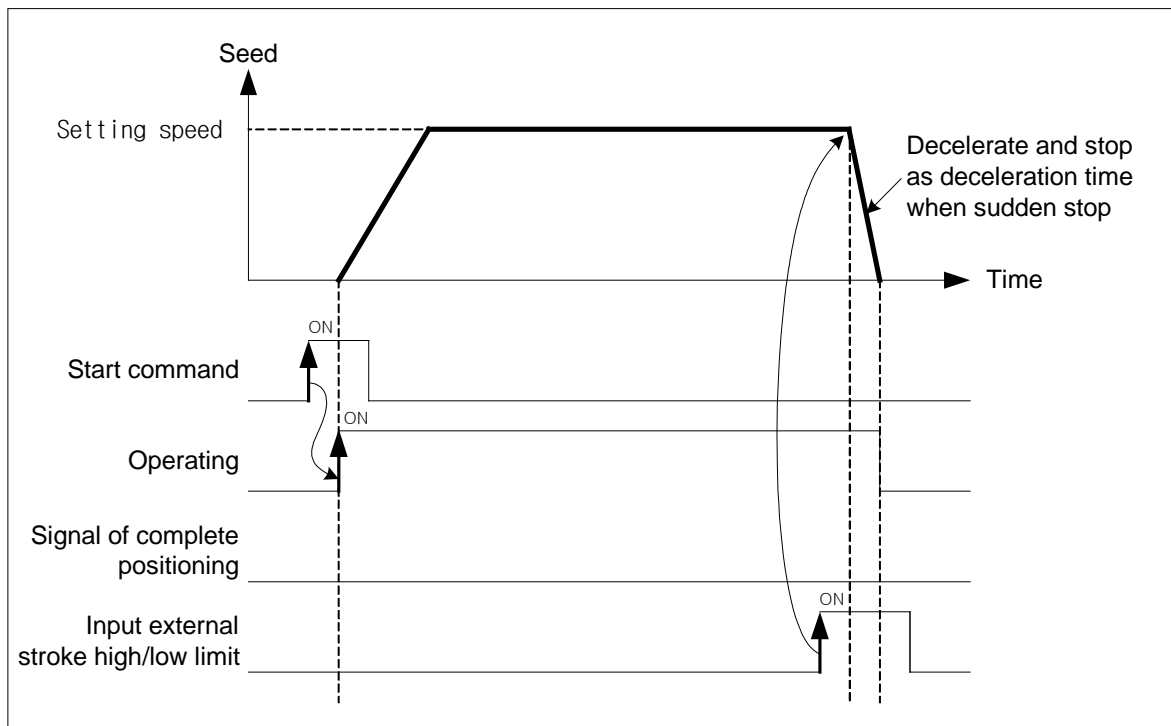

(5) Stop by software high/limit

- (a) When positioning control, if value of current command position out of set value of expansion parameter in 「software high limit」 and 「software low limit」, it will promptly be stopped without outputting value of command position.
- (b) If value of command position to be out of software high limit range, will occur error 501, and if it to be out of software low limit range, will occur error 502.

■ Setting related parameter (expansion parameter)

Item	Setting value	Contents
Software high limit	-2147483648 ~ 2147483647	Set position of software high limit.
Software low limit	-2147483648 ~ 2147483647	Set position of software low limit.

(c) Condition

Software high/low limit not to be checked in the following case:

- In case of setting Software high/low limits as maximum (2147483647), minimum (-2147483648)
- In case of "Software high limit = Software low limit"

(d) Motion timing

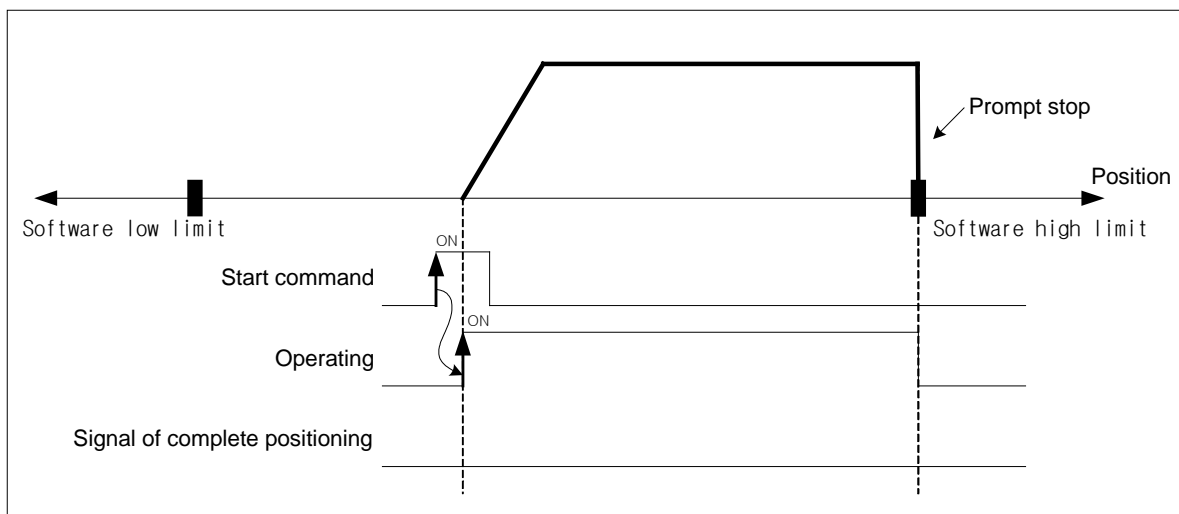

Chapter 8 Functions

(6) The priority of stop process

The priority of stop process of positioning module is as follows:

Deceleration stop < Sudden stop

When encounter factor of sudden stop in deceleration stop of positioning, it will be suddenly stopped. In case of sudden stop deceleration time bigger than deceleration stop time, it will be decelerated and stopped as set deceleration stop time.

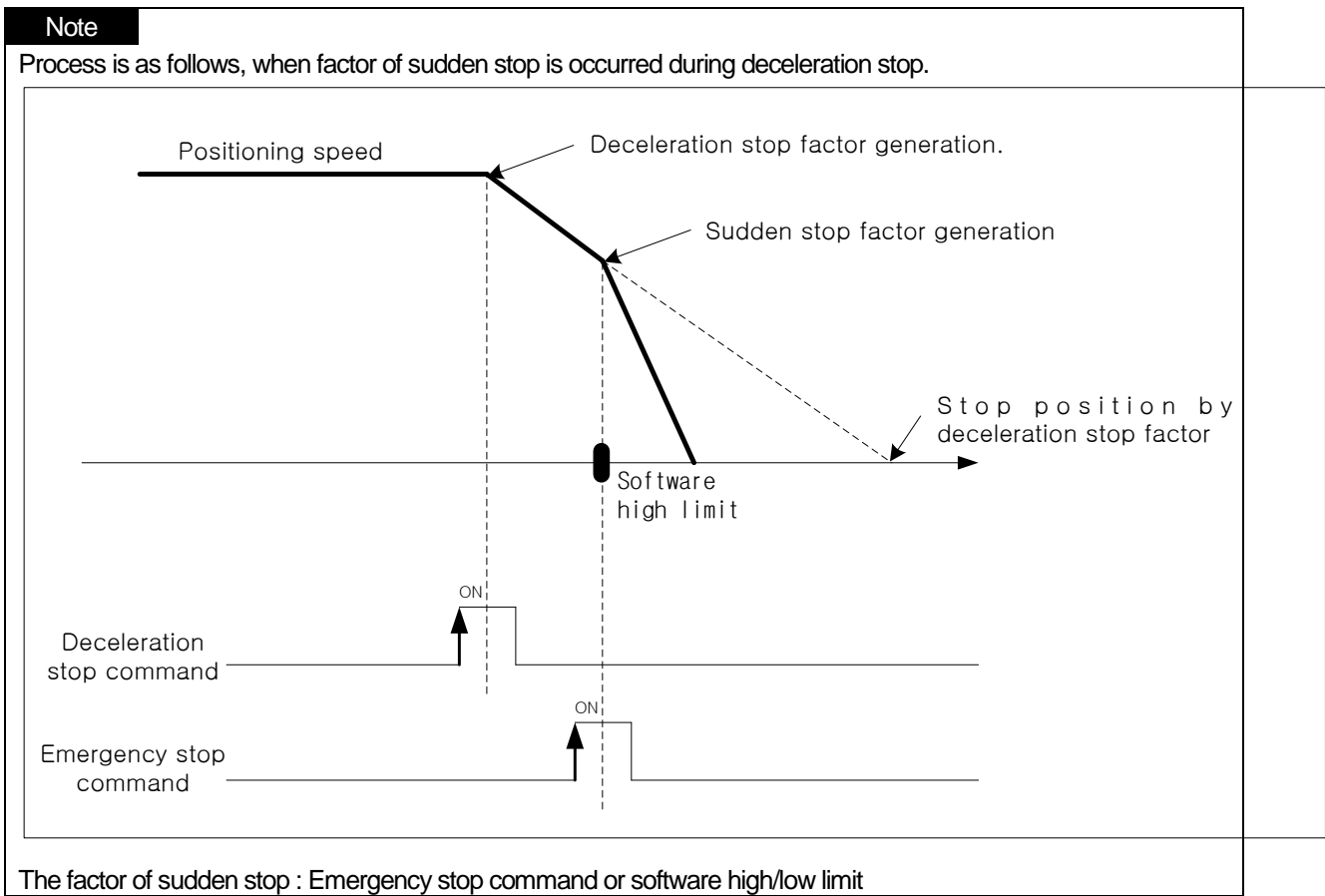

(7) Stop command under interpolation operation

- (a) If encounters stop command during interpolation operation (linear interpolation, circular interpolation, helical interpolation, elliptic interpolation), it carries out the deceleration stop. It depends on the trace of wheels of origin.
- (b) When it restarts after deceleration stop, indirect start command carries out operation to target position of positioning. And then, operation depends on absolute coordinate and relative coordinate.
- (c) Stop command during interpolation operation can external/internal deceleration stop.
- (d) Deceleration stop command should be progressed at main axis which is operating for interpolation.
- (e) Operation pattern

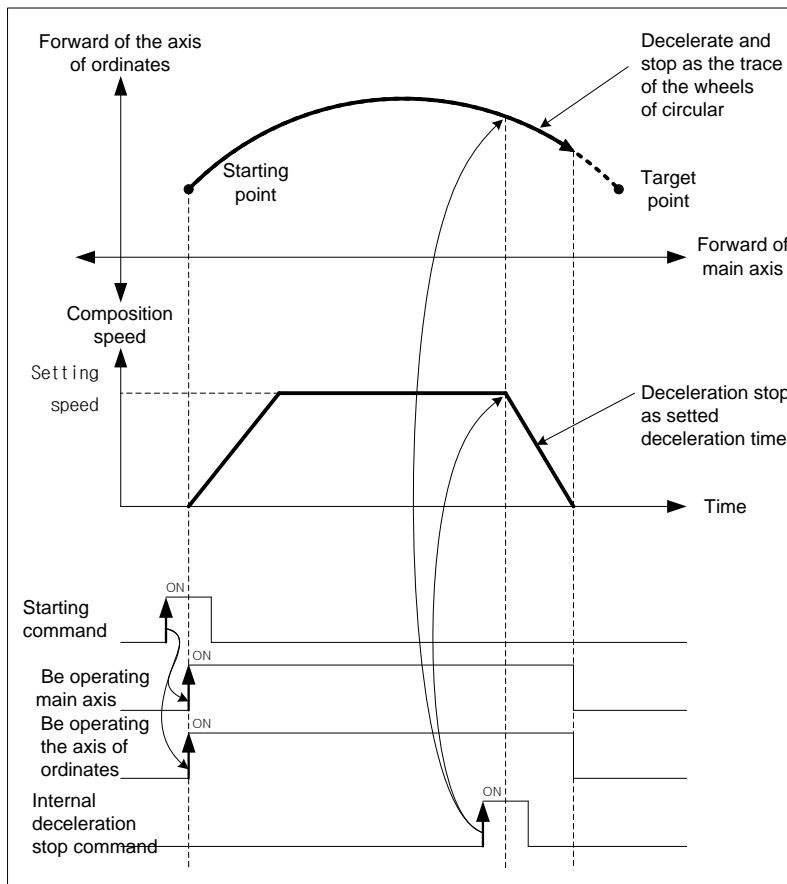

(8) Restart after Positioning stop

(a) Deceleration stop

When indirect start after deceleration stop, operate positioning as set operation step.

In case of using with mode, Signal "On" of M code has to "Off" for restart.

Signal On of M code have to be changed "Off" by 「Cancellation M code (XMOF)」 command.

(b) Restart after Internal/External emergency stop

In case of emergency stop, signal On of M code will automatically be "Off", therefore can operate positioning as set operation step, when it operate indirect start.

Chapter 8 Functions

8.3 Manual Operation Control

Manual control is a function that execute random positioning according to user's demand without operation data
Manual operations include Jog operation, Manual pulse generator operation, inching operation, previous position movement of manual operation etc.

8.3.1 Jog Operation

(1) Characteristic of Control

(a) Jog Operation is

- Execute positioning control at jog high/low speed depending on the signal of high/low speed during forward/reverse jog start signal is being ON.
- Positioning is started by Jog command from the state that the origin is determined. The value of positioning starts changing, user can monitor it.
- This is a way of manual operation that can be executed before determination of origin.

(b) Acceleration/Deceleration process and Jog speed

The acceleration/deceleration processing is controlled based on the setting time of Jog acceleration/ deceleration time from XG-PM manual operation parameter setting.

Set the Jog speed on Jog high/low speed of XG-PM manual operation parameter setting.

If Jog speed is set out of the setting range, error will occur and the operation does not work.

■ Parameter setting (Manual Parameter)

Item	Setting value	Description
Jog High Speed	1 ~ Speed limit	Set Jog speed. Jog high speed must be set below speed limit
Jog Low Speed	1 ~ Jog High Speed	Set Jog speed. Jog low speed must be set below Jog high speed
Jog Acc. Time	0 ~ 2147483647	Set the acc. Time used in acceleration of Jog operation
Jog Dec. Time	0 ~ 2147483647	Set the dec. time used in deceleration of Jog operation

Note

If "Jog Acc. Time" is 0, it operates at "Acc. Time1" of basic parameter.

If "Jog Dec. Time" is 0, it operates at "Dec. Time1" of basic parameter.

(2) Operation Timing

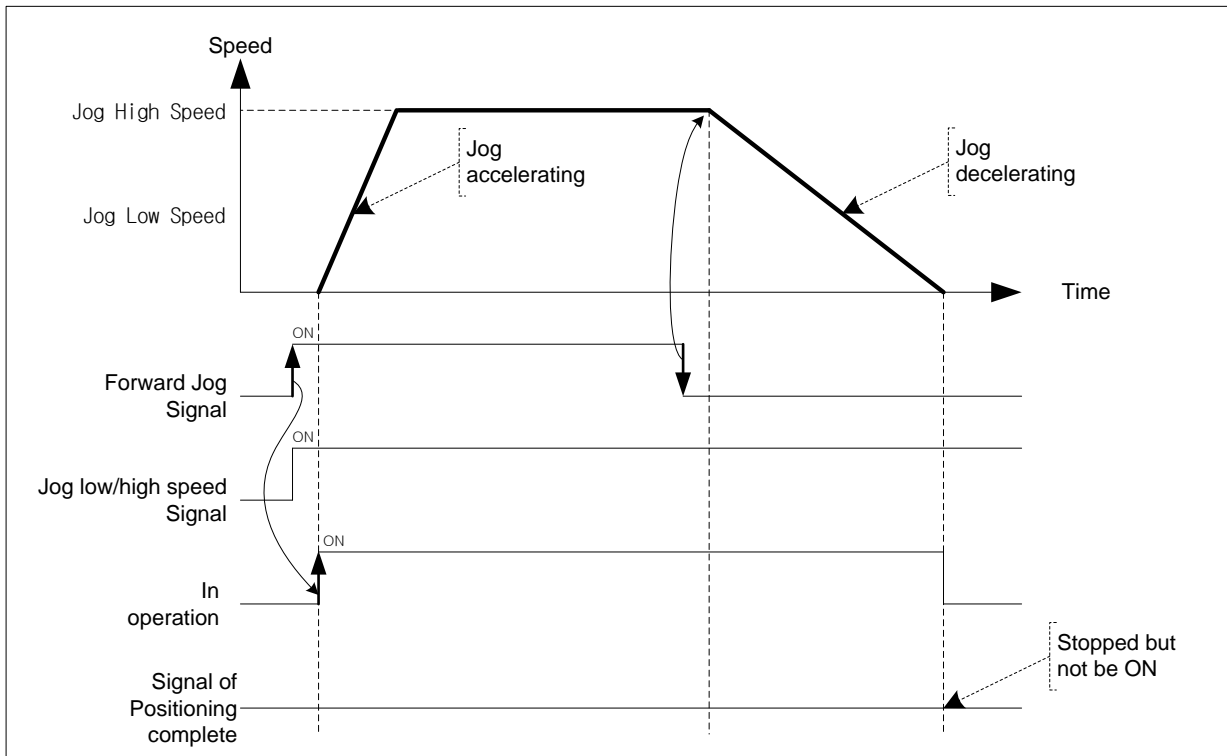

Note

Notices for setting Jog speed are as follows.

Jog Low Speed ≤ Jog High Speed ≤ Speed Limit

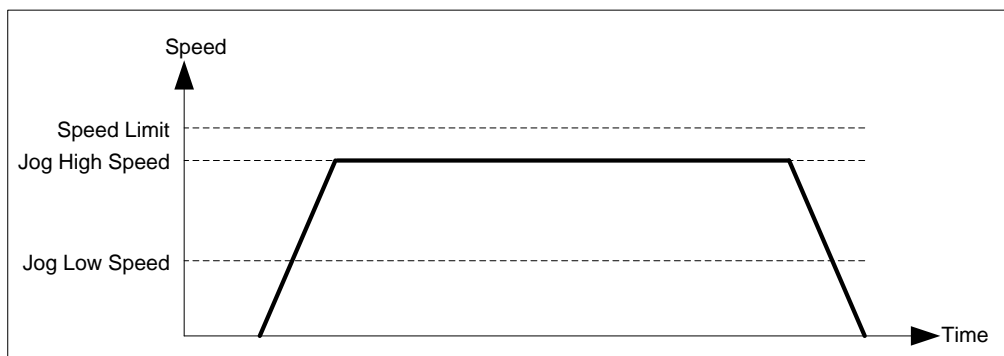

(3) Restrictions

You can not execute Jog operation in the case as follows.

- (a) Value of Jog High Speed exceeds the speed limit of basic parameter (Error code : 121)
- (b) Value of Jog Low Speed exceeds the value of Jog high speed. (Error code : 122)

Chapter 8 Functions

(4) Jog Operation Start

Jog operation start consists of Start by XG-PM and Start by Sequence program. The start by sequence program is that execute Jog operation with output contact of CPU.

Axis	Direction of Signal : CPU -> Positioning module	
	Output Signal	Description
Axis1	U01.01.0	Axis1 Forward Jog
	U01.01.1	Axis1 Reverse Jog
	U01.01.2	Axis1 Jog Low/High Speed
	U01.01.3	-
Axis2	U01.01.4	Axis2 Forward Jog
	U01.01.5	Axis2 Reverse Jog
	U01.01.6	Axis2 Jog Low/High Speed
	U01.01.7	-
Axis3	U01.01.8	Axis3 Forward Jog
	U01.01.9	Axis3 Reverse Jog
	U01.01.A	Axis3 Jog Low/High Speed
	U01.01.B	-
Axis4	U01.01.C	Axis4 Forward Jog
	U01.01.D	Axis4 Reverse Jog
	U01.01.E	Axis4 Jog Low/High Speed
	U01.01.F	-

[Example] Execute Jog start in the order as follows.

- Forward Jog Low speed Operation -> Forward Jog High speed Operation -> Stop
- Reverse Jog High speed Operation -> Reverse Jog Low speed Operation -> Stop

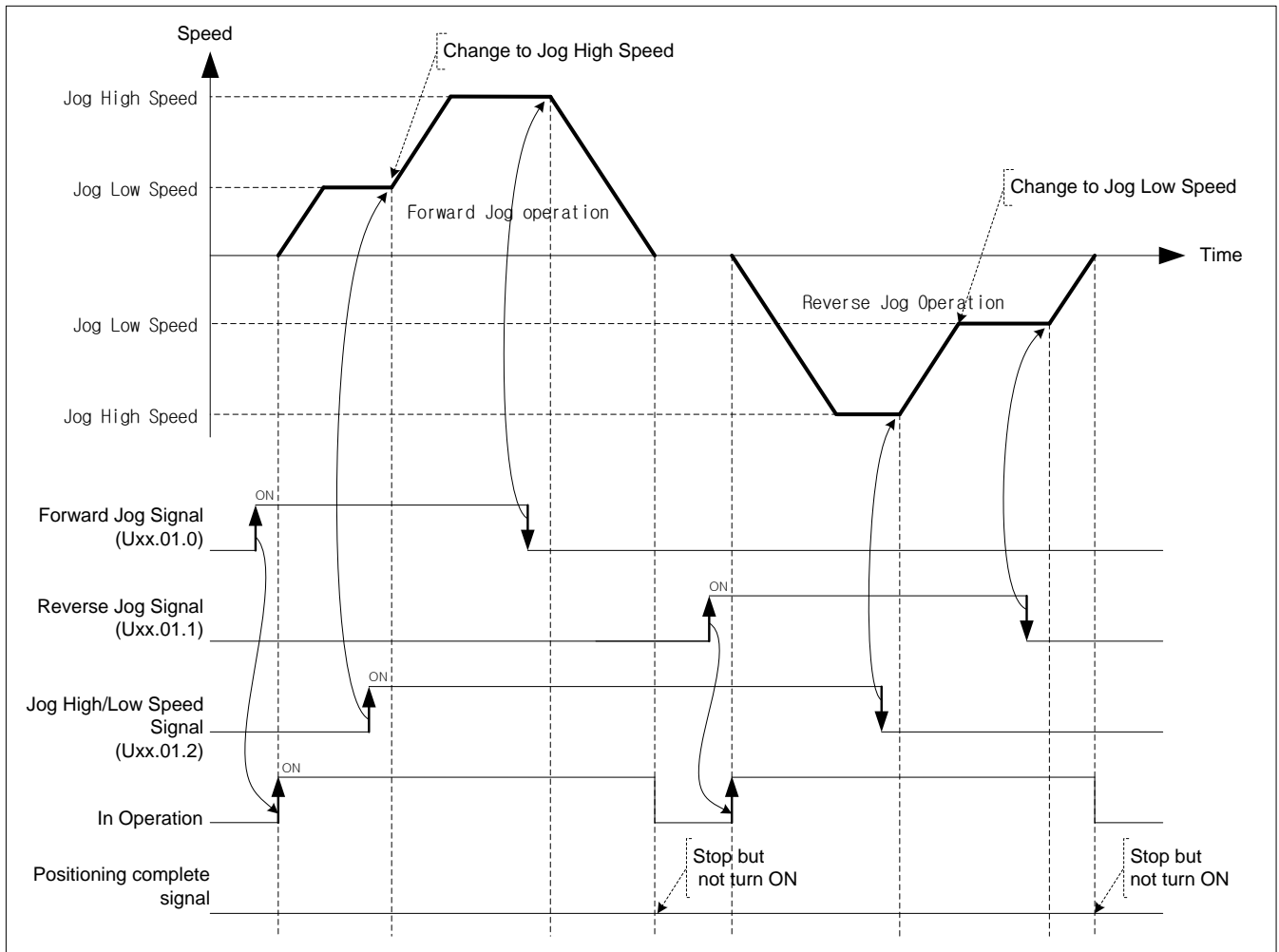

Note

Dec. stop command will not be executed in Jog Operation.
Jog operation will stop if turn the Jog signal of the current operating direction Off.

Chapter 8 Functions

8.3.2 Inching Operation

This is a kind of manual operation and executing positioning at the speed already set on manual operation parameter as much as the amount of movement already set on the data of inching operation command.

(1) Characteristics of Control

- (a) While the operation by ON/OFF of Jog signal is difficult in moving to the correct position as the operation starts and stops according to the command, the inching command enables to set the desired transfer amount easily and reach the goal point.
- (b) Thus, it is available to reach the correct goal position by moving fast near the working position by Jog command and operating the detail movement by inching command.
- (c) The setting range is $-2147483648 \sim 2147483647$ Pulse.
- (d) The direction of moving depends on the amount of inching.
 - The amount is POSITIVE(+) : Positioning operation in forward direction
 - The amount is NEGATIVE(-) : Positioning operation in reverse direction
- (e) Acc./Dec process and Inching speed

Use Jog acc./dec. Time of manual operation as acc./dec. time of Inching operation.

Set Jog acc./dec. time on "Jog acc./dec. time" of manual operation parameter setting of XG-PM.

Set Inching speed on "Inching speed" of manual operation parameter setting.

If inching speed is set out of the setting range, error will occur and the operation does not work.

■ Related parameter setting (Manual operation parameter)

Items	Setting value	Description
Jog acc. Time	0 ~ 2147483647	Set the accelerating time for acceleration of Inching operation
Jog dec. Time	0 ~ 2147483647	Set the decelerating time for deceleration of Inching operation
Inching Speed	1 ~ Speed limit	Set the speed of Inching operation

(2) Operation Timing

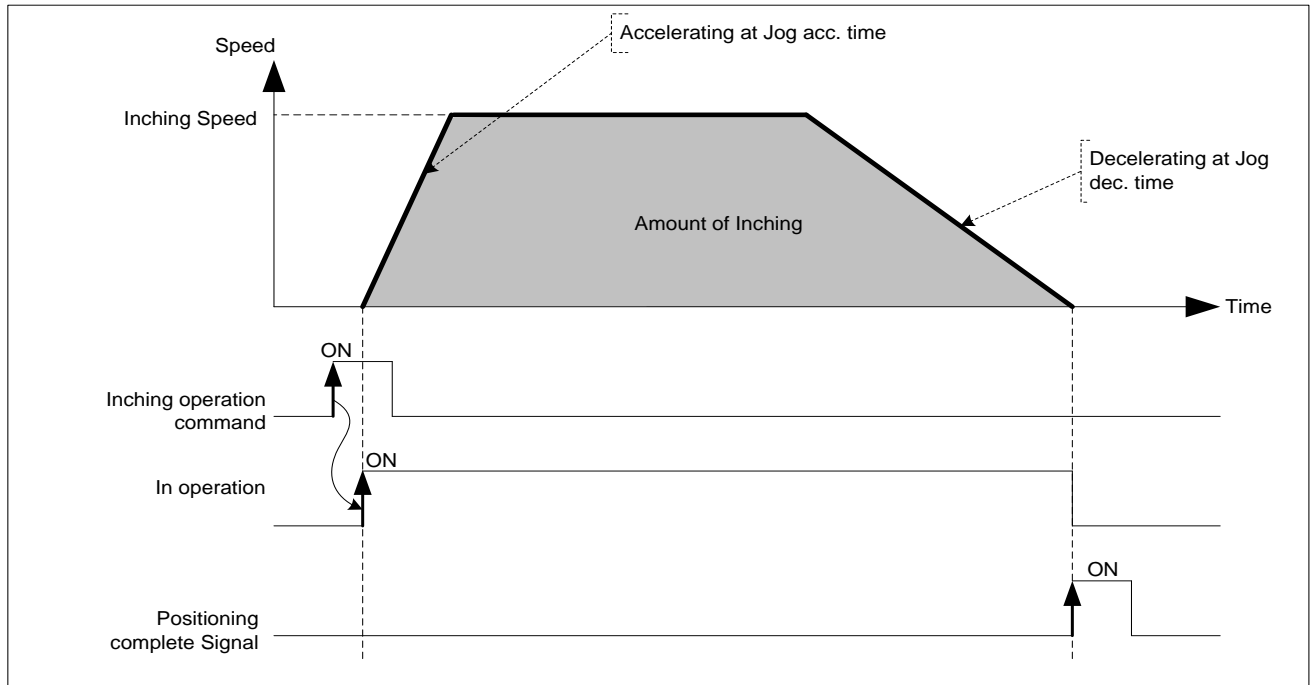

Chapter 8 Functions

8.3.3 Returning to the previous position of manual operation

This positioning control function is used to return to the position address that the positioning is completed before manual operation when the position is changed by manual operation (Jog operation, inching operation).

(1) Characteristic of Control

(a) Direction of moving depends on the current position and the previous position of manual operation.

- Starting position < The previous position of manual operation : Forward direction
- Starting position > The previous position of manual operation : Reverse direction

(b) Acc./Dec. process and the speed of return

Acc./Dec. time of returning is the same as homing acc./dec. time of homing parameter.

Set acc./dec. time on homing acc./dec. time of homing parameter of XG-PM.

If returning speed is set out of the setting range, error will occur and the operation does not work.

■ Related parameter setting (Homing Parameter)

Item	Setting value	Description
Homing speed	1 ~ Speed limit	Set returning speed
Homing acc. time	0 ~ 2147483647	Set acc. time used in return
Homing dec. time	0 ~ 2147483647	Set dec. time used in return

(2) Operation timing

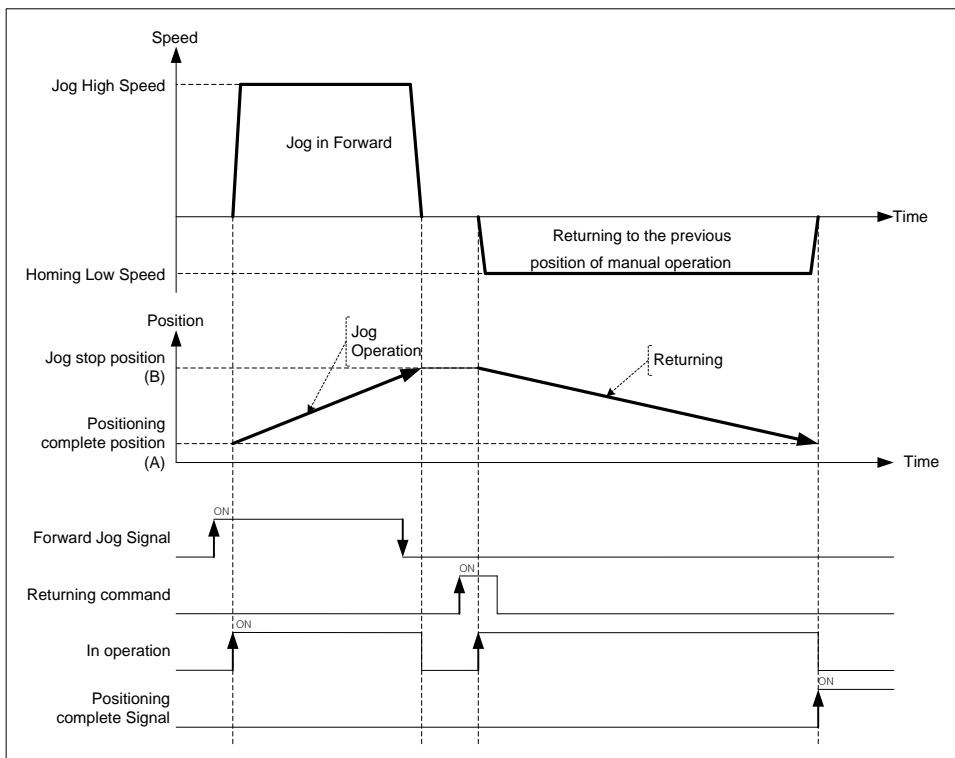

If value of the current position is "A" after positioning control operation and the positioning value changed by Jog operation is "B", execute positioning to "A" when executing the returning to the previous position of manual operation.

8.4 Synchronous Control

This is the command that control the operation synchronizing with the main axis or operating of encoder.

8.4.1 Speed Synchronous Control

This is the command that synchronize with sub axis in speed and control operation depending on speed synchronous rate already set when main axis starts.

(1) Characteristic of Control

- (a) Start and Stop is repeated depending on operating of main axis after execution of speed synchronous command. The operating direction of sub axis and the main's are same.
- (b) The operating direction of sub axis depends on the ratio of speed sync. $\left(\frac{SubAxis}{MainAxis}\right)$. If it is positive, the direction is forward. If it is negative, the direction is reverse.
- (c) If execute speed sync. command, it will be the state of operating and remain in the state of speed sync. operation before release of speed sync. command.
- (d) Auxiliary data of speed sync. command

The auxiliary data used in speed sync. command is as follows.

Item	Setting value	Description
Main Axis	1(axis1) ~ 4(axis4), 9(Encoder)	Set the main axis of speed sync.
Ratio of Main axis	-32768 ~ 32767	Set the ratio of main axis at speed sync. ratio.
Ratio of Sub axis	-32768 ~ 32767	Set the ratio of sub axis at speed sync. ratio..

Ratio of Speed sync. is calculated as follows.

$$Ratio = \frac{SubAxis}{MainAxis}$$

It is possible to set like "Ratio of Main axis(Absolute) < Ratio of Sub axis(Absolute)" at setting ratio of speed sync.

Operating speed of sub axis is calculated as follows.

$$\begin{aligned} \text{Operating speed of SubAxis} &= \text{Operating Speed of MainAxis} \times \text{Ratio of speed sync.} \\ &= \text{Operating Speed of MainAxis} \times \frac{\text{Ratio of SubAxis}}{\text{Ratio of MainAxis}} \end{aligned}$$

- (e) Modifying the ratio of speed sync. in operation is available.

When modify the ratio, if there is too big gap between the former ratio and the current ratio, the machine is possible to be damaged.

(2) Operation Timing

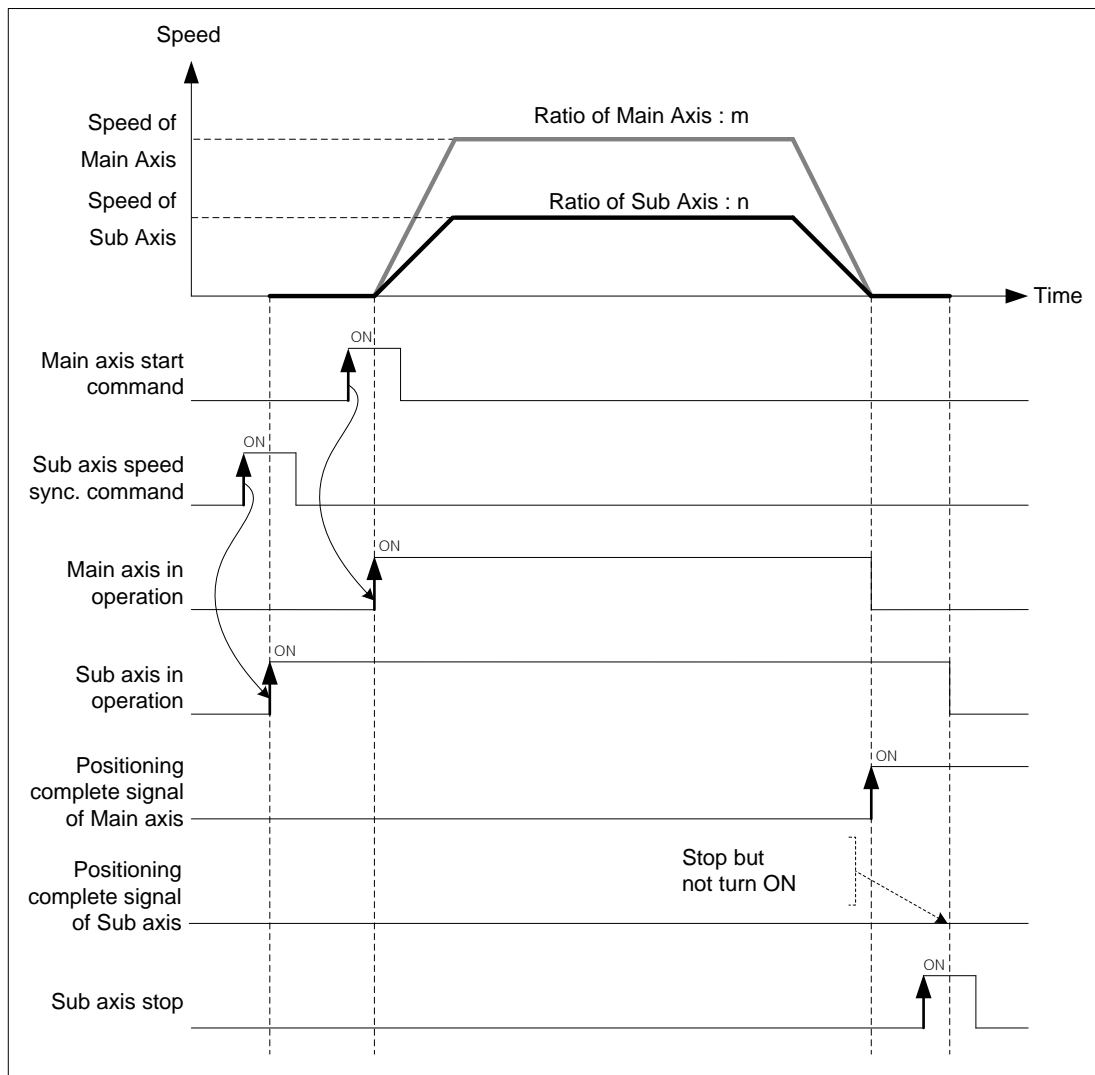

(3) Restrictions

You can not execute Jog operation in the case as follows.

- If speed sync. is executed in being On of M code signal, error (code:353) arises. Make M code "off" with M code release command (XMOF) before use.
- In the case that the axis set as main axis is not the axis can be set or the case that the setting of main axis is the same as the setting of command axis, error (code"355) arises. Set the main axis among the axis available to be set.
- If the speed of main axis exceeds the speed limit, error (code:357) arises. In the case, the speed of main axis has to be down below the speed limit.

In the case that the speed of main axis exceeds the speed limit, error arises and it decelerate in "Dec. time of emergent stop".

Note

If master axis is encoder, input frequency can be recognized as 1000pps even though the actual input speed is lower than 1000pps. In this case, the speed limit error can be occurs according to synchronous ratio. Therefore, Care must be taken when master axis is encoder.

[Example] axis1 is main axis, axis2 is sub axis. Operate at “ratio of main axis : ratio of sub axis = 2 : 1” at the beginning and then execute speed sync. control changing the ratio to “ratio of main axis : ratio of sub axis = 1 : 2”

■ Example of setting in XG-PM

▫ Operation data of main axis(axis1)

Step no.	Control method	Operation method	Goal Position [pls]	Operating speed [pls/s]	Acc. no.	Dec. no.	M code	Dwell Time
1	Relative, Reduction position control	Single, End	10000	2000	No. 1	No. 1	0	0

■ Operating pattern

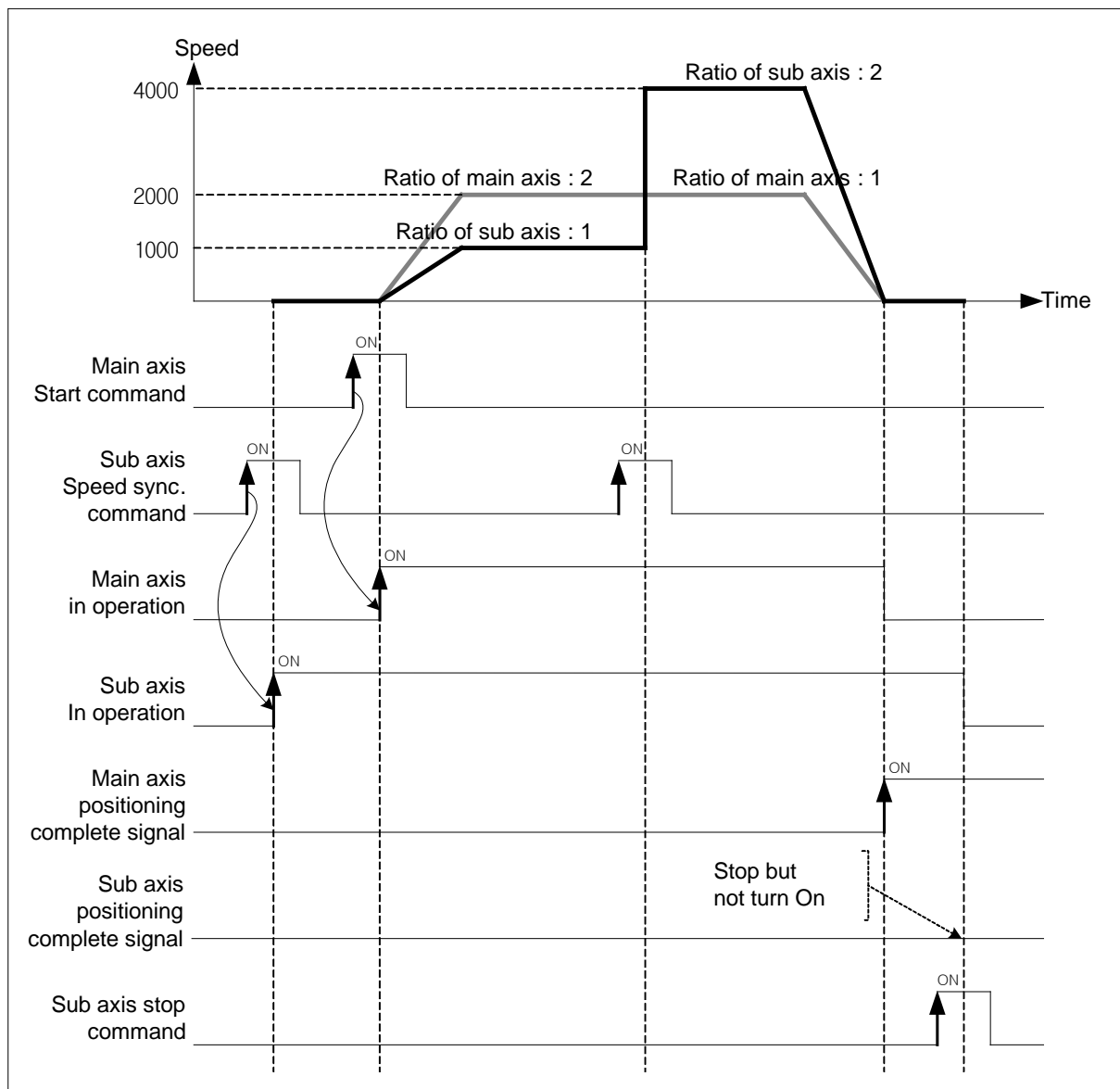

Chapter 8 Functions

(4) Speed synchronous control with encoder

- (a) Set encoder as the main axis of speed sync. and execute positioning control by ratio of speed sync. that consists of pulse speed from encoder, ratio of main axis and ratio of sub axis.
- (b) This command is used in the case that executing through positioning manually.
- (c) After executed speed sync. command, when the pulse string is inputted, speed sync. control starts.
- (d) Operate regardless of the state of origin.
- (e) The pulse inputted by encoder increase or decrease the position value of encoder.
- (f) The direction of moving depends on encoder pulse input mode and ratio of speed sync.
 - Encoder direction in PHASE A/B 1 multiplying
 - Positioning in forward direction : Input pulse of A phase is ahead of B's
 - Positioning in reverse direction : Input pulse of B phase is ahead of A's

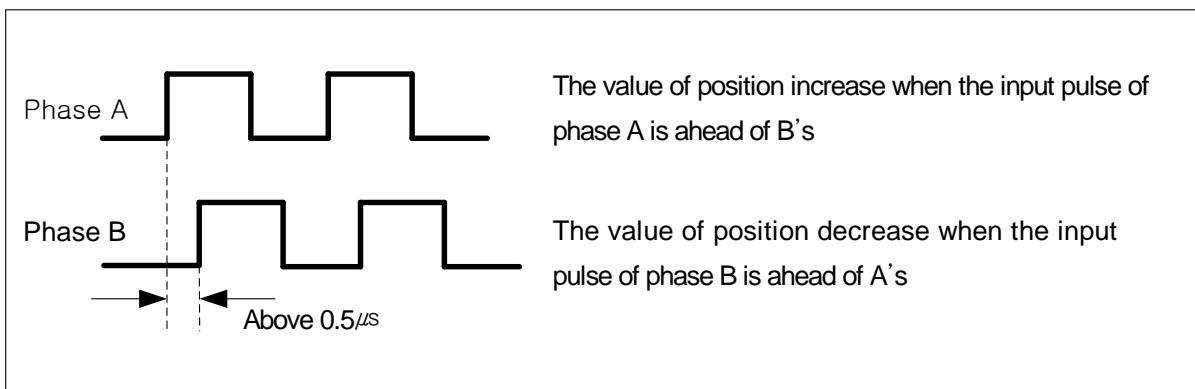

- The operating direction of sub axis depends on $Ratio\ of\ speed\ sync. \left(\frac{Ratio\ of\ SubAxis}{Ratio\ of\ MainAxis} \right)$. If it is positive, operating direction will be forward direction of encoder. If it is negative, operating direction will be reverse direction of encoder.

(g) Related parameter (Common Parameter)

Set parameter related to encoder on common parameter.

Item	Setting Value	Description
Encoder Pulse Input	0 : CW/CCW 1 multiplying 1 : PULSE/DIR 1 multiplying 2 : PHASE A/B 4 multiplying	Set the encoder to use in input of encoder
Maximum of encoder	-2147483647 ~ 2147483647	Set the count range with max./min. of encoder
Minimum of encoder	-2147483647 ~ Max. of Encoder	

[Example] Execute speed sync. control with encoder (main axis), axis2(sub axis) at “the ratio of main axis : the ratio of sub axis = 1 : 2”.

(Hypothesize that the input speed of encoder is 1Kpps)

When the direction of encoder is forward, the operating direction of sub axis is reverse. When the direction of encoder is reverse, the operating direction of sub axis is forward.

■ Operating pattern

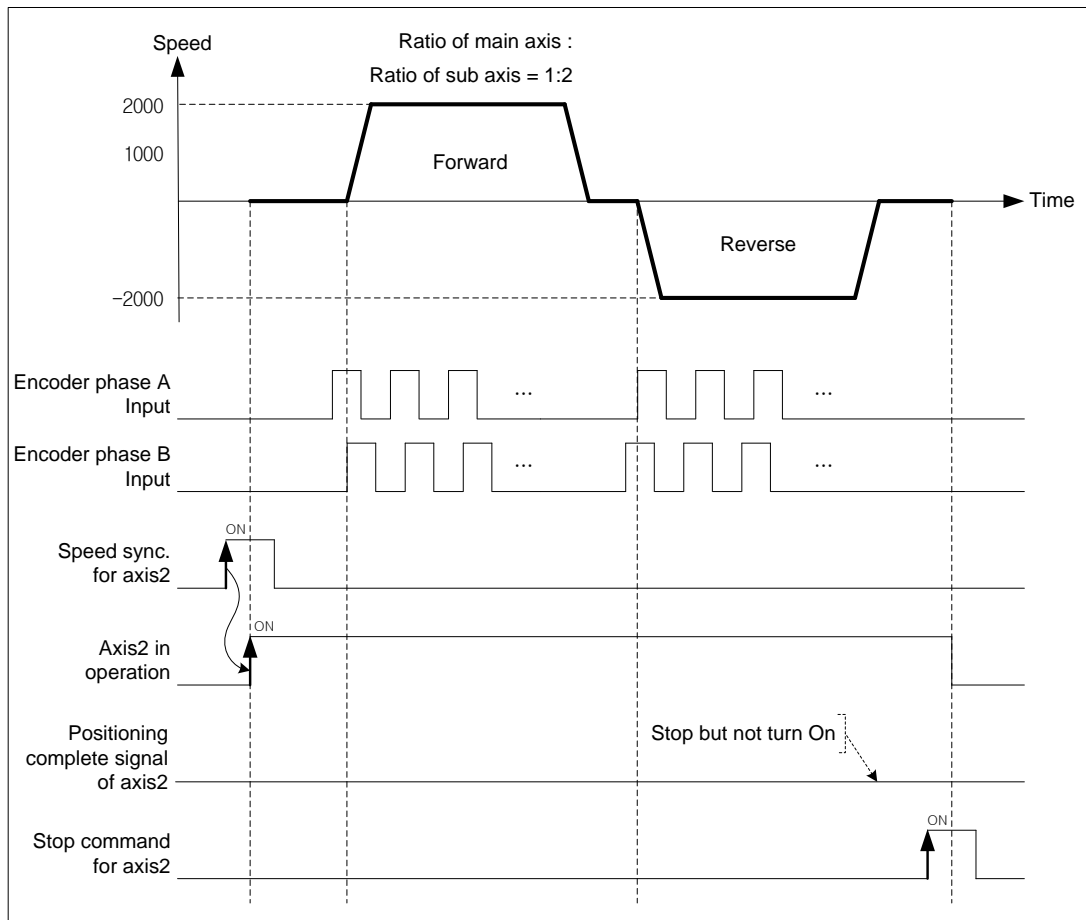

Chapter 8 Functions

(5) Positioning speed sync. control

- (a) The basic operation of positioning speed sync. control is similar to speed synchronization. After executing positioning speed sync. command, start and stop are repeated depending on operation of main axis. The direction of sub axis and the direction of main axis are same.
- (b) The operating direction of sub axis depends on *Ratio of speed sync.* ($\frac{\text{Ratio of SubAxis}}{\text{Ratio of MainAxis}}$). If it is positive, operating direction will be forward direction of main axis. If it is negative, operating direction will be reverse direction of main axis.
- (c) If give speed sync. command to sub axis, it will be changed to the operating state and stay at operating state until release command.
- (d) If the current position of sub axis become the goal position, it stops speed sync. and stay there. For the details, refer to "Speed sync. control".
- (e) Auxiliary data of positioning speed sync. command.

The auxiliary data used in speed sync. is as follows.

Items	Setting value	Description
Main axis	1(axis1) ~ 4(axis4), 9(Encoder)	Set main axis
Ratio of main axis	-32768 ~ 32767	Set ratio of main axis
Ratio of sub axis	-32768 ~ 32767	Set ratio of sub axis
Goal position	-2147483648 ~ 2147483647	Set the goal position of positioning speed sync.

(f) Operation timing

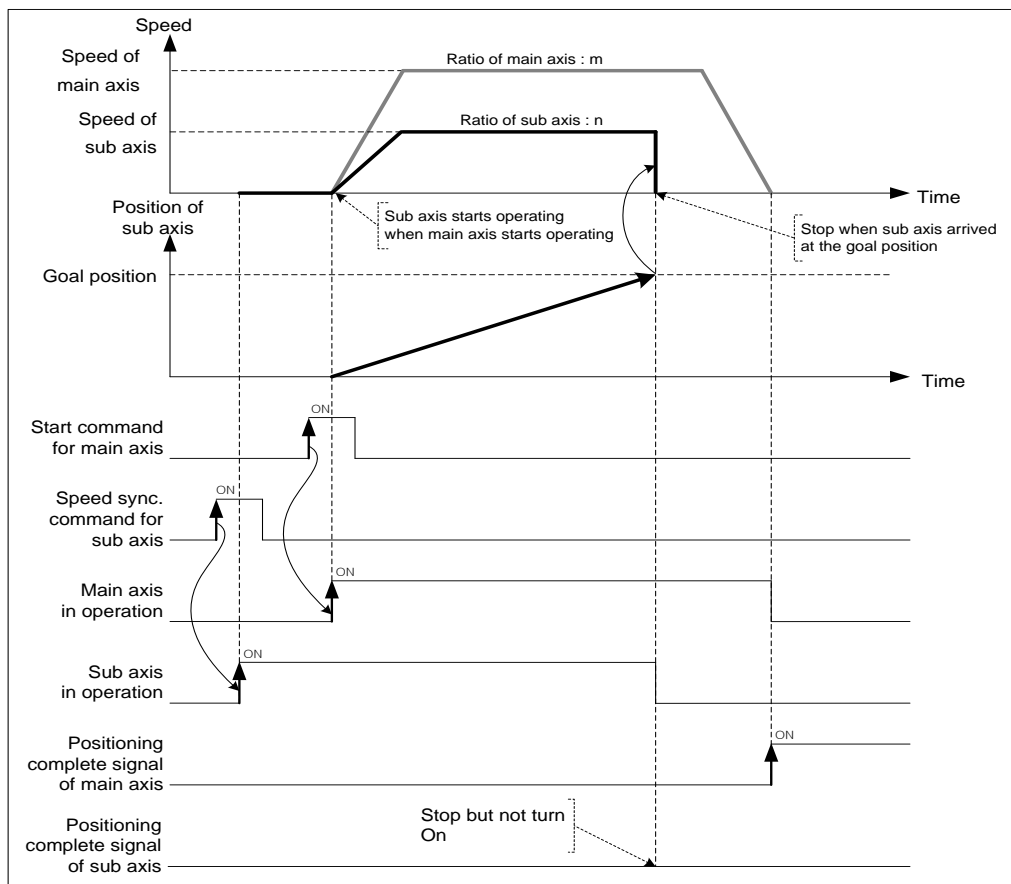

8.4.2 Position synchronous control

Start positioning with step no. and operation data when the current position of main axis is same as the position set in position sync.

(1) Characteristics of control

- (a) Synchronous Start by Position (SSP) command is carried out only in case that the main axis is in the origin determination state.
- (b) SSP command starts by the synchronization of the subordinate axis according to the current position of the main axis.
- (c) SSP carries out the SSP command at the subordinate axis.
- (d) If SSP command is executed, it becomes the state in operation and the actual operation is carried out at the subordinate axis where the current position of the main axis is the setting position of the position synchronous start.
- (e) In case of cancellation after executing the SSP command at the subordinate axis, if you execute the stop command, the SSP command shall be released.
- (f) The auxiliary data of position sync. command

The auxiliary data used in position sync. is as follows.

Items	Setting Value	Description
Position of position sync.	-2147483648 ~ 2147483647	Set the position of main axis in position sync. control
Operation step	1 ~ 400	Set the step no. to be executed when the main axis arrives at the position for position sync.
Main axis	1(axis1) ~ 4(axis4), 9(Encoder)	Set the main axis of position sync.

Note

Even though the current position of main axis and the setting value set on position sync. are not exactly same, if the current position of main axis is at between the position of main axis of previous scan and the current position of main axis, the sub axis will be executed with the positioning data of step no. set on operation step.

(2) Operation timing

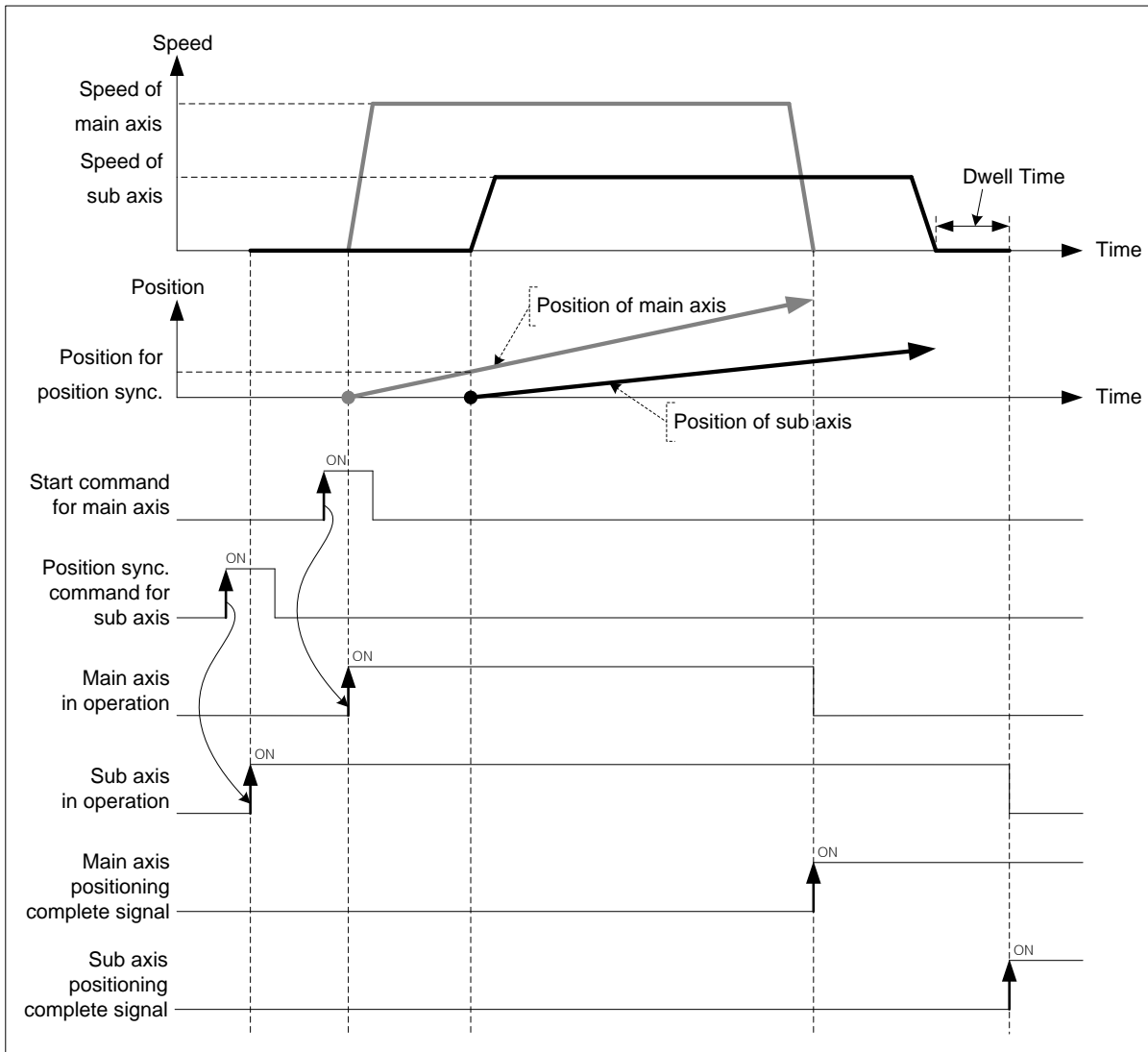

(3) Restrictions

Position sync. control can be executed in the case below.

- If position sync. command is executed in M code signal is On, error (code:343) arises. Use it after making M code "Off" with M code release command(XMOF).
- If the current main axis is not the axis can be set on the current module or main axis and command axis are the same axis, error (code:355) arises. Set the main axis among one of the axis can be set on module.

[Example] Axis1 is main axis, axis2 is sub axis. The position of main axis for position sync. is 1000, execute position sync. with operation data no.10.

- The current position of axis1 : 0
The current position of axis2 : 0

■ Example in XG-PM

- Main axis (axis1) Operation data

Step no.	Control method	Operation	Goal position [pls]	Operating speed [pls/s]	Acc. no.	Dec. no.	M code	Dwell time
1	Relative, Single axis position control	Single axis, End	2000	1000	No. 1	No. 1	0	0

- Sub axis (axis2) Operation data

Step no.	Control method	Operation	Goal position [pls]	Operating speed [pls/s]	Acc. no.	Dec. no.	M code	Dwell time
10	Relative, Single axis position control	Single axis, End	2000	2000	No. 2	No. 2	0	0

■ Operating pattern

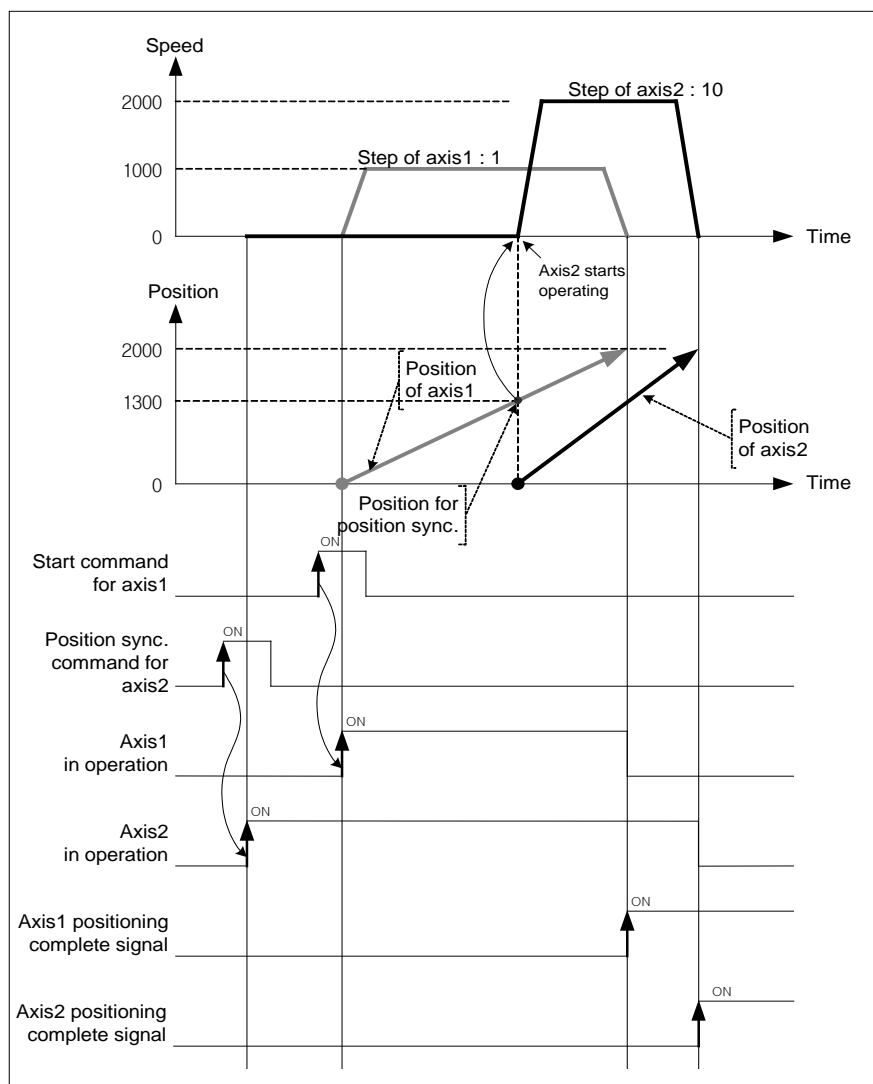

Chapter 8 Functions

8.4.3 CAM Operation

CAM axis control synchronizing with the position of main motor.

(1) Characteristics of Control

(a) Replace existing mechanical work of CAM with software CAM operation

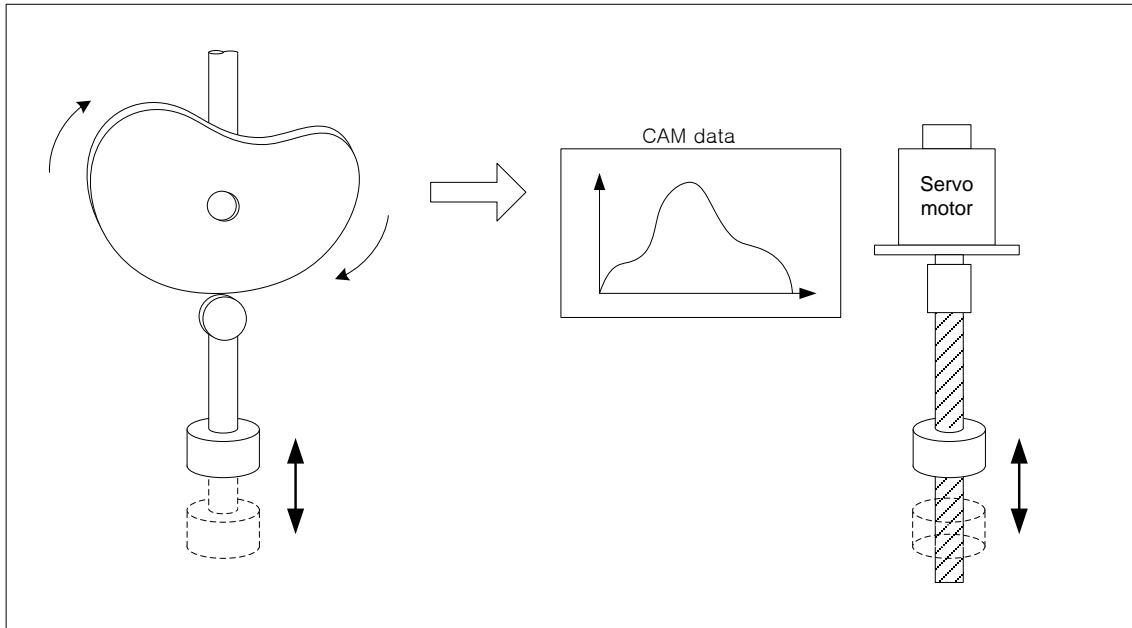

(b) You may write max. 9 CAM data blocks and apply it to each axis.

(c) Each block consists of 2048 CAM data.

(d) Auxiliary data of CAM command

Auxiliary data used in CAM command is as follows.

Item	Setting value	Description
Main Axis	1(Axis1) ~ 4(Axis4), 9(Encoder)	Set the main axis of CAM operation
CAM block	1(no.1) ~ 8(no.8)	Set CAM block no.
Main axis offset	-2147483648 ~ 2147483647	Set the position of main-axis position as offset value if main-axis reaches this position, the sub-axis starts CAM operation.

Encoder can not be used as main axis.

You may set different CAM block no. for each axis. In addition, it is possible to execute CAM operation with the same CAM block. In order to use user CAM operation, you have to set up CAM block number as 8.

- (e) You can make sub-axis start the CAM operation at the specified position of main-axis by setting the "Main axis offset". Main axis offset setting is available at "Offset specified CAM start command (XCAMO, XPM_CAMO).
- (f) Create CAM data by setting CAM parameter on XG-PM to use CAM.
- (g) After main axis is operated, input the calculated value per CAM block setting and point unit based on the current value per rotation of main axis. For the detail description, refer to "(3) Principle of CAM operation".
- (h) If CAM operation is executed on sub axis, it become 'operating status' and keep executing CAM operation with CAM data according to the position of main axis until stop command.

(2) CAM Parameter

The table below describes the parameter items for writing CAM data.

Item	Setting Range	Description
Main/Sub axis parameter	Unit	pulse, mm, inch, degree
	Transfer distance per 1 rotation	Depending on Unit
	No. of Pulse per 1 rotation	1 ~ 200000000
CAM control mode	Control method	Repeat, Increase
	Point unit	No. of pulse per 1 rotation
CAM block data	Starting position of main axis	Depending on Unit
	Ending position of main axis	
	Starting position of sub axis	
	Ending position of sub axis	
	CAM curve	Straight Line ~ 7 th curve

(a) Main/Sub parameter setting

1) Unit

Set the control unit of main/sub axis. Set the same as the value already set on "Unit" of basic parameter.

Item	Setting Range	Remarks
Unit of main axis	pulse, mm, inch, degree	-
Unit of sub axis	pulse, mm, inch	Degree may not be used.

2) Transfer distance per 1 rotation

Set the transfer distance per 1 rotation of main/sub axis. The unit of transfer distance is according to 1).

If the unit is "mm" or "inch", this value is the maximum last position of main/sub axis.

Transfer distance per 1 rotation is depending on unit.

■ Setting range for transfer distance per 1 rotation

Unit	Setting Range	Remarks
pulse	-	No need to set
mm	0.1 ~ 20000000.0 um	The maximum last position of main/sub axis
inch	0.00001 ~ 2000.00000 inch	The maximum last position of main/sub axis
degree	360.00000 Fixed	No need to set The maximum last position of main/sub axis

3) No. of pulse per 1 rotation

Set the no. of pulse per 1 rotation of main/sub axis.

If the unit is "pulse", the value is the maximum last position of main/sub axis

Chapter 8 Functions

(b) CAM control mode setting

1) Control method

Set the form of CAM repeat pattern. "Repeat mode" and "Increase mode" may be set.

▪ Repeat (Two-way mode)

Execute round-trip motion repeatedly in the range already set from starting position of sub axis to ending position according to the position of main axis in 1 rotation.

When CAM data is created in repeat, the ending position of the last step of sub axis user last set must be set as 0.

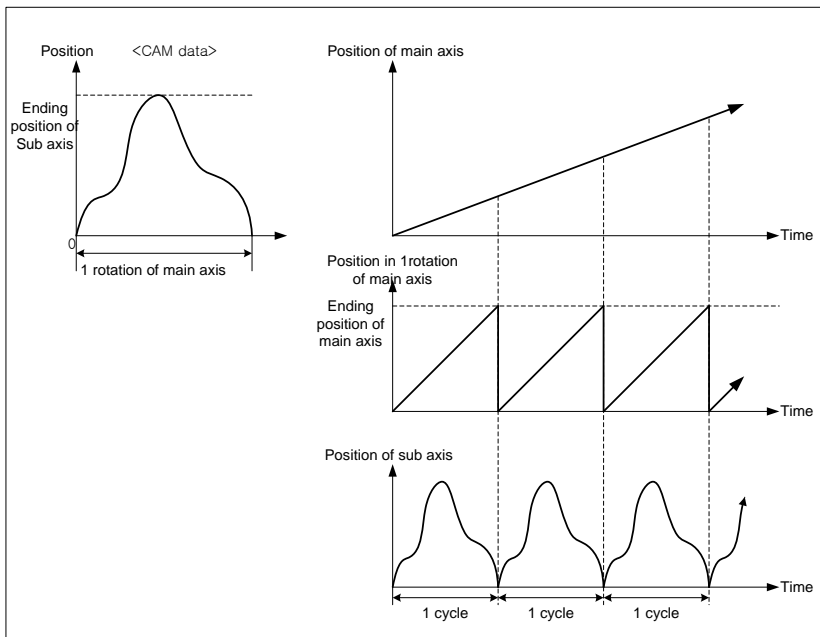

▪ Increase (Feed mode)

Execute CAM operation from starting position of sub axis to ending position according to the position in 1 rotation of main axis.

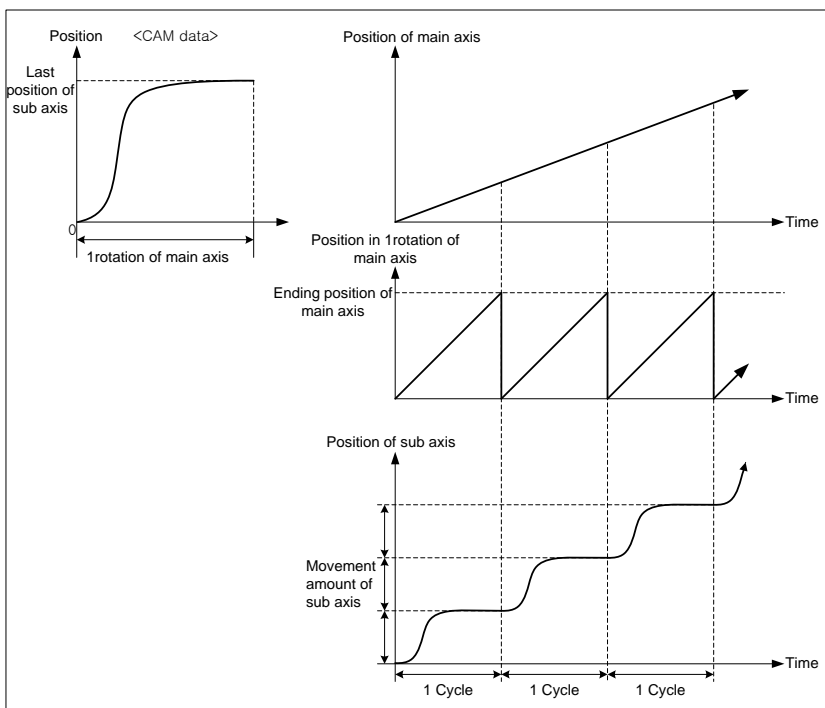

2) Point unit

Set the resolution ranging from starting position of main axis to ending position of main axis on each step data of CAM block data setting. When CAM data is created, calculate the position of sub axis corresponding to the position of main axis from the starting position of main axis by point unit. The smaller point unit is, the more no. of CAM data is, so you may execute much smoother CAM operation. However, if point unit is small, no. of CAM data exceeds 2048, so there is a chance that user can not create CAM data.

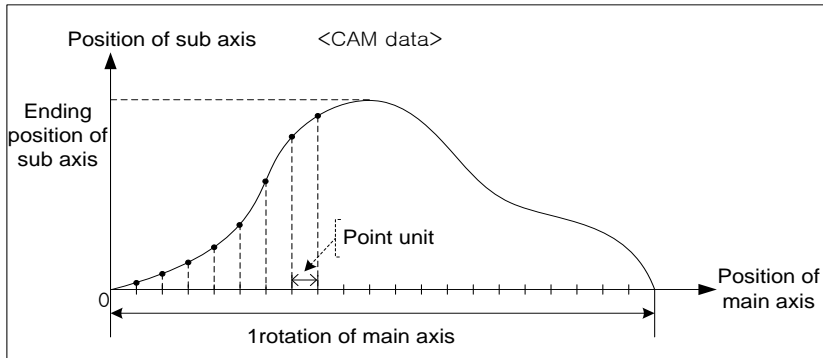
**Note**

When set CAM block data after point unit setting, "Ending position of main axis" must be set as positive multiple number of point unit. For example, if the unit of main axis is "degree" and point unit is 10, "Ending position of main axis" must be set as multiple number of 10 like 40, 90, 180, ...

Chapter 8 Functions

(c) CAM block data setting

20 data sections may be set in a CAM block and every section may have specific curve.

1) Starting position of main axis

Set the starting position of main axis in designated section. Starting position of main axis is the same as the ending position of main axis in previous section.

2) Ending position of main axis

Set ending position of main axis in designated section. The ending position of main axis in the last section must be set as much as the transfer distance per 1 rotation set on main/sub axis parameter.

3) Starting position of sub axis

Set the starting position of sub axis corresponding to the starting position of main axis in the designated section. Starting position of sub axis is the same as the ending position of sub axis in previous section.

4) Ending position of sub axis

Set ending position of sub axis corresponding to the ending position of main axis in the designated section. If control method is "Repeat (Two-way mode)", the ending position of sub axis in the last section must be 0. If control method is "Increase(Feed mode)", the ending position of sub axis in the last section generally has to be set as much as the transfer distance per 1 rotation set on main/sub axis parameter.

5) CAM curve

Set CAM specific curve to create data ranging from starting position of sub axis to ending position of sub axis in the designated section. The position of sub axis is calculated by characteristic of selected CAM curve, the position of main axis increase by point unit at the same time.

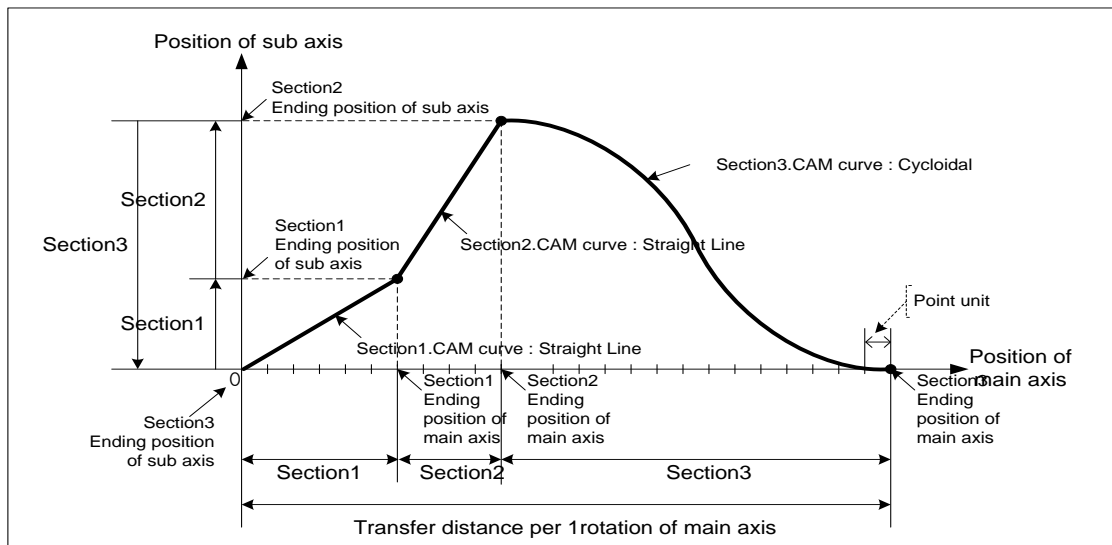

There are 22 kinds of CAM curve.

Describe characteristic of each CAM curve on next page.

■ Characteristic of CAM curve

Name	Acc. type	Position (S_{max})	Speed (V_{max})	Acc. (A_{max})	Jerk (J_{max})
Straight Line		1.00000	0.00000	0.00000	0.00000
Constant Acceleration		1.00000	2.00000	4.00000	0.00000
Simple Harmonic		1.00000	1.57076	4.93409	2.46735
No-Dwell Simple Harmonic		1.00000	1.57076	4.93409	2.46735
Double Harmonic		1.00000	2.04047	5.55125	0.10285
Reverse Double Harmonic		1.00000	2.04048	9.86605	4.93455
No-Dwell Modified Constant Velocity		1.00000	1.22203	7.67383	3.83881
Modified Constant Velocity		1.00000	1.27526	8.00947	0.98712
No-Dwell Modified Trapezoid		1.00000	1.71788	4.19885	2.09942
One-Dwell Modified Trapezoid		1.00000	1.91589	4.43866	55.77788
Modified Trapezoid		1.00000	1.99975	4.88812	0.30562
Asymmetrical Modified Trapezoid		1.00000	1.99982	6.11015	0.47620
One-Dwell Cycloidal		1.00000	1.75953	5.52756	0.17345
Cycloidal		1.00000	1.99985	6.28273	0.19715
Asymmetrical Cycloidal		1.00000	1.99989	7.85304	0.30783
One-Dwell Trapezoid		1.00000	1.73636	4.91007	0.30699
Reverse Trapezoid		1.00000	2.18193	6.16975	0.38579
Trapezoid		1.00000	2.18193	6.17044	0.38579
One-Dwell Modified Sine		1.00000	1.65978	5.21368	0.32603
Modified Sine		1.00000	1.75953	5.52697	0.34562
5th Curve		1.00000	1.87500	5.77350	60.00000
7th Curve		1.00000	2.18750	7.51283	41.99646

Chapter 8 Functions

(3) Principle of CAM operation

- (a) When CAM operation command is executed, the current position of main axis is recognized as 0.
- (b) When the main axis starts operating, "the current position in 1 rotation of main axis" increase to "no. of pulse per 1 rotation (-1)" then become 0. The position value (0~"no. of pulse per 1 rotation (-1)") is repeated.
- (c) Calculate CAM data step no. corresponding to "the current position per 1 rotation" with "point unit" of CAM parameter.

$$\text{Cam Data Step no.} = \frac{\text{Current Positio per 1rotation of Main Axis}}{\text{Point Unit}}$$

For example, if the position of main axis at the beginning of CAM operation is 1000, the current position is 1073 and point unit is 10, the step no. of CAM data is as follows.

$$\begin{aligned} \text{Cam Data Step no.} &= \frac{\text{Current Positio per 1rotation of Main Axis}}{\text{Point Unit}} \\ &= \frac{1073 - 1000}{10} \\ &= 7.3 \end{aligned}$$

(d) Calculate update position of sub axis with CAM data step. If main axis is forward direction, calculate the position of sub axis with the position corresponding to "the part of positive number of CAM data step no." and the position corresponding to "the part of positive number of CAM data step no. +1".

$$\begin{aligned} &\text{Position of sub axis} \\ &= \{(\text{Step position of CAM data} + 1) - (\text{Step position of CAM data})\} \times \text{Decimal part of CAM data step no.} \\ &\quad + (\text{Step position of CAM data}) \end{aligned}$$

For example, if position value of sub axis of step 7 is 395 and step 8's is 475, the position of sub axis is as follows.

$$\begin{aligned} \text{Position of sub axis} &= 395 + (475 - 395) \times 0.3 \\ &= 395 + 24 \\ &= 419 \end{aligned}$$

(4) Operation timing

(a) General CAM command

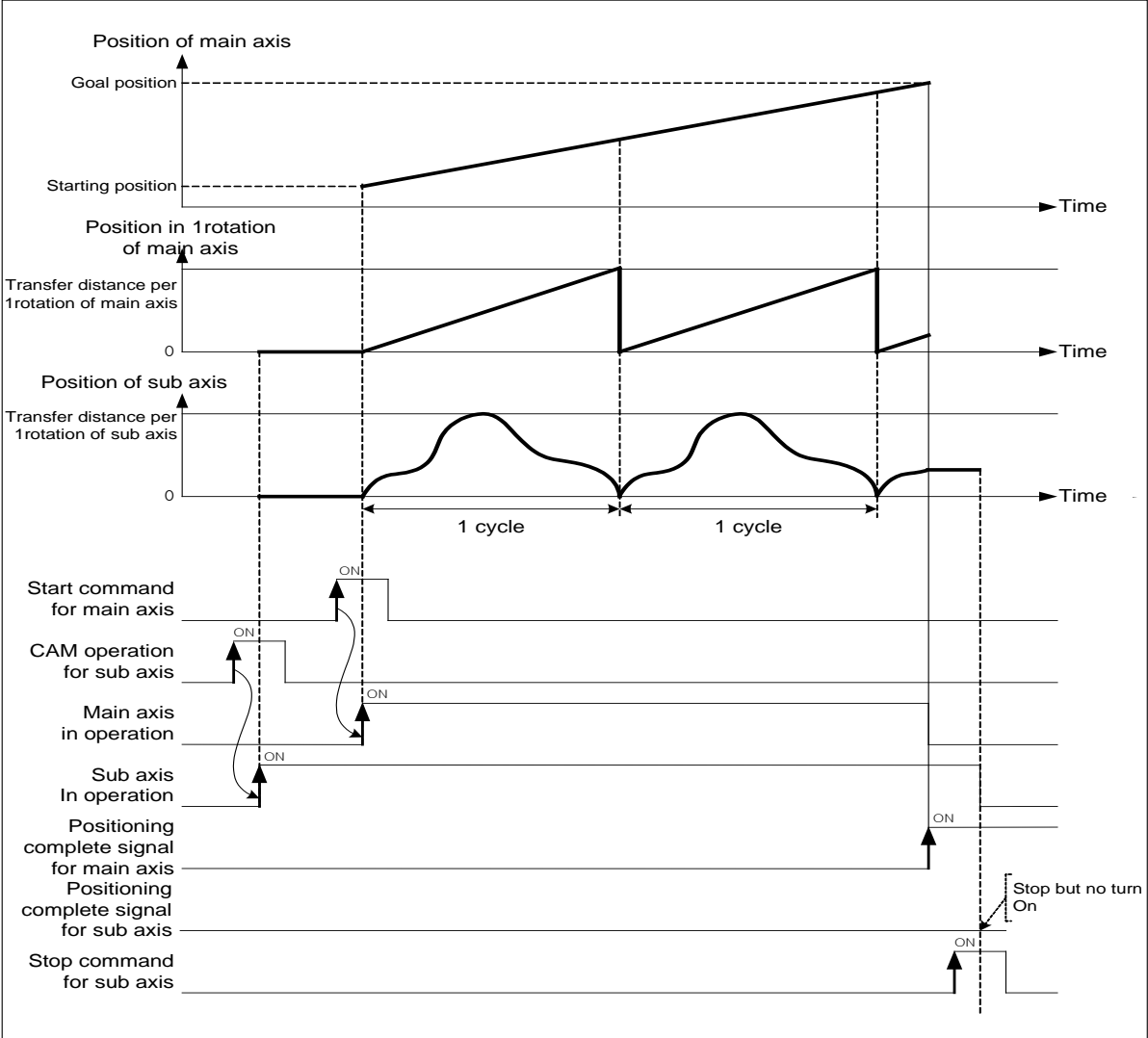

Chapter 8 Functions

(a) Master axis offset designated CAM command

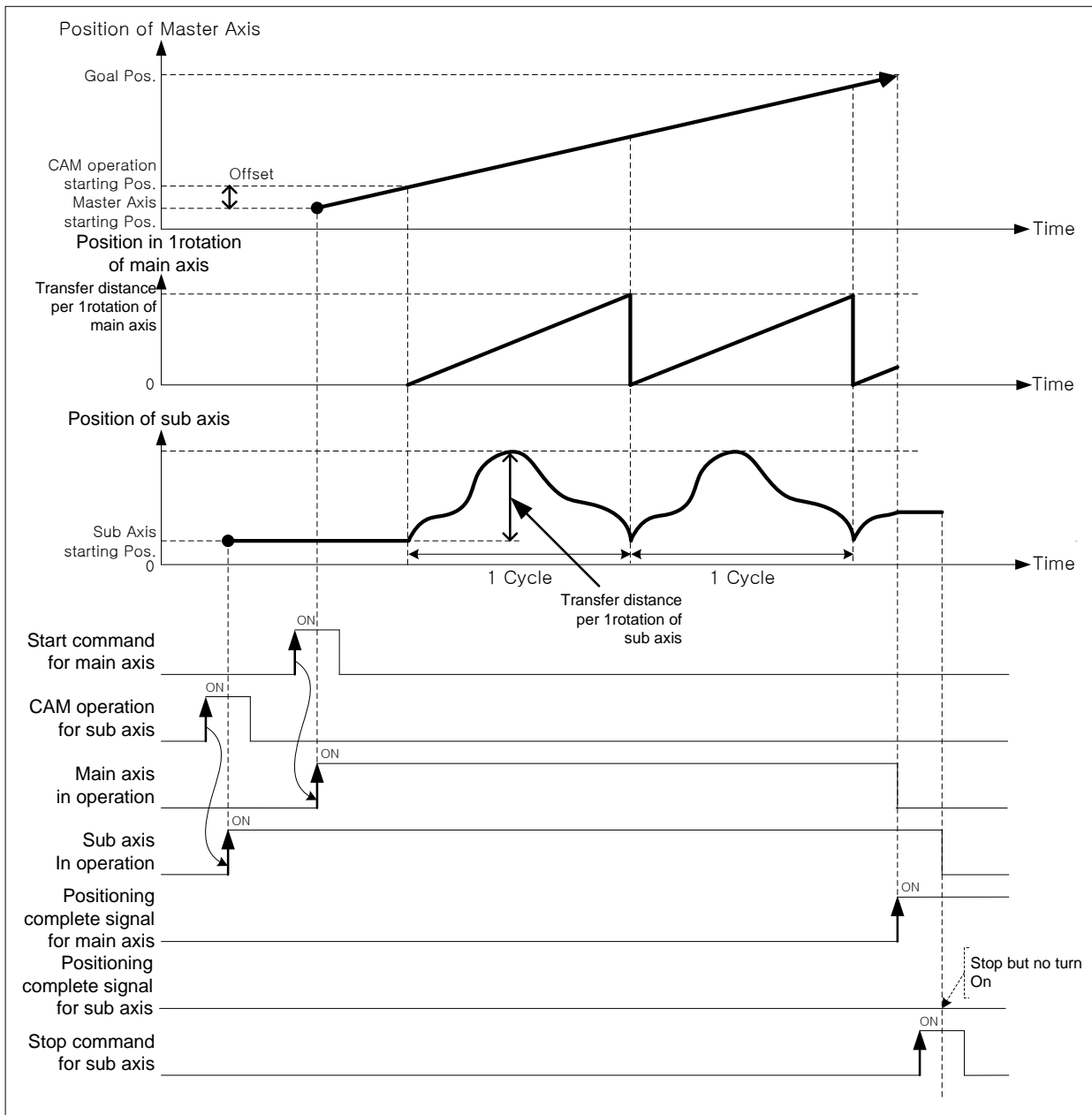

(5) Restrictions

CAM operation command may not be executed in the cases below.

- If execute CAM operation command in being On of M code, error (code:702) arises. Make M code "OFF" with "M code release (XMOF)" command before use.
- If the current main axis is not the axis can be set on the current module or main axis and command axis are the same axis, error (code:704) arises. Set the main axis among one of the axis can be set on module.
- If speed of main axis is too fast and speed of sub axis exceeds speed limit, error (code:708) arises. In this case, you have to lower the operation speed.

8.4.4 User CAM Operation

User CAM operation, like CAM operation, executes CAM axis control in which CAM data shown as CAM curve synchronize with position of the motor set as main-axis. The difference with CAM operation is that user sets up CAM data not in XG-PM but in PLC program (XG5000), and the number of CAM data is 30.

1) Operation

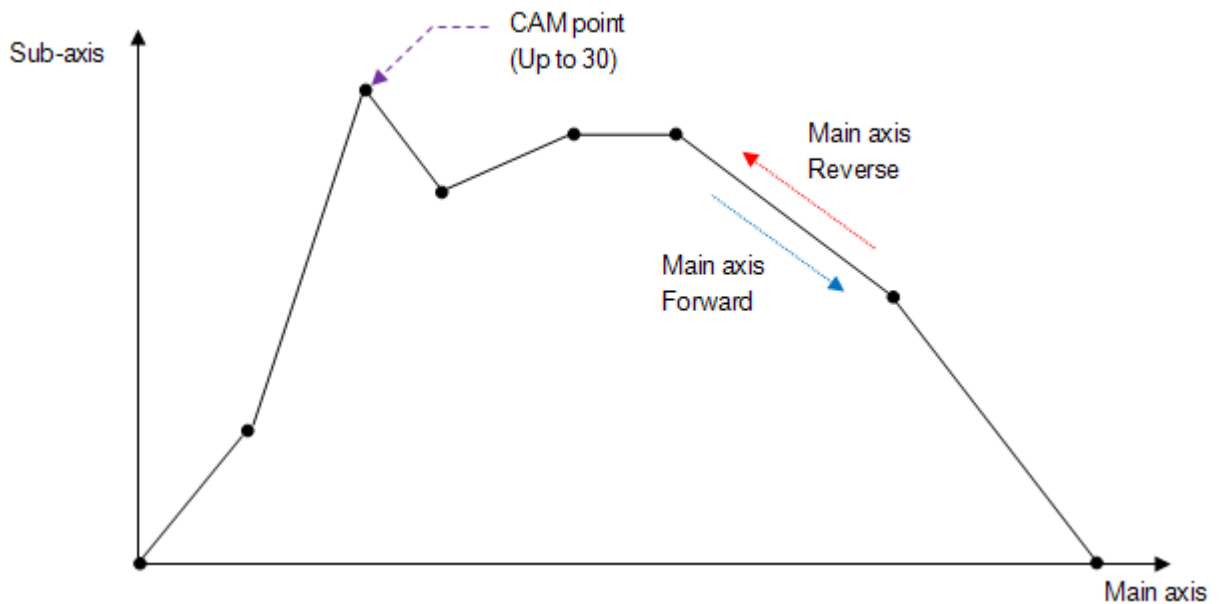

Like figure above, you can set up maximum 30 CAM data points, and it operates CAM curve between CAM points with straight line. CAM point data is set up at sub-axis and as type of (main-axis position, sub-axis position). CAM data point can be saved at the specified memory address of each axis by using “Write Variable Data” (XVWR, XPM_VWR) command. For memory address to save CAM data point of each axis, refer to 3.10 User CAM data memory address.

Note

Change of User CAM data is available when the User CAM is operating. The changed User CAM data is applied after finishing the implementing cycle. This function can be used without stop of User CAM operation.

Changing User CAM when operating is only available in continuous operation.

Take notice that control period should be increased(1ms->5ms)

For more information, refer to Continuous operation in 4.7.2Common Parameter Setting.

	Item	Settings
Common Parameter	Pulse output level	0: Low Active
	Enc pulse input	0: CW/CCW (x1)
	Enc max. value	2147483647
	Enc min. value	-2147483648
	Speed override	0: Specify %
	Continuous opr.	1: Enable

8.5 Modification Function of Control

8.5.1 Floating Origin Setting

This is used to force to set the current position as the origin without carrying out the homing action of the machine.

(1) Characteristic of Control

- (a) Modify the current position into "Homing end position" of homing parameter and become Origin-decided status.
- (b) After floating origin setting command is executed, the current position is changed to "The position of homing completion" of homing parameter.
- (c) Related parameter (Homing Parameter)

Items	Setting value	Description
Position of homing completion	-2147483648 ~ 2147483647	Set the position after homing completion or floating origin setting

Note

Floating origin setting just executes forced origin-decision from the current position to origin completion position. So user need to take notice as follows.

- (1) When error arose, clear the cause of error and reset,
- (2) set floating origin again,
- (3) change the operation step no. to operate with start step no. change command and then execute.

(2) Operation timing

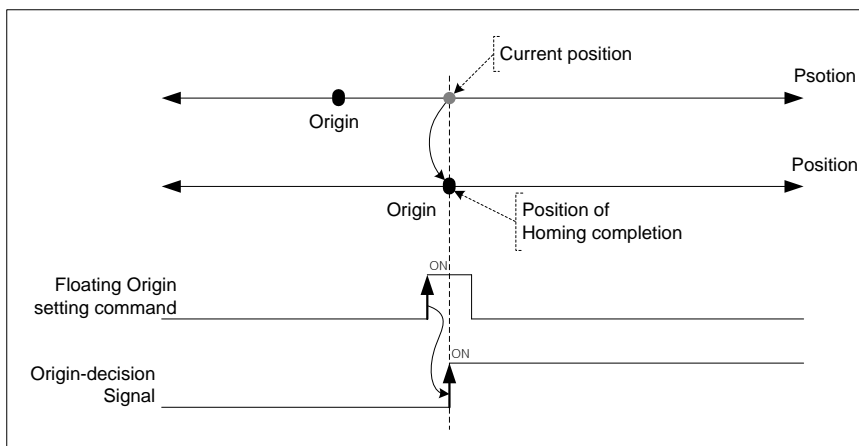

(3) Restrictions

If drive ready signal is in "OFF", floating origin setting command is not executed but error (code:212)arises. When drive ready signal is in "ON", execute floating origin setting command.

8.5.2 Continuous Operation

Execute positioning control changing the current operation step no. to the next one.

(1) Characteristics of Control

- When continuous operation command is executed, operating speed is changed into the speed of next operation step directly.
- This command may be used in End, Go on, Continuous mode and used at Acc., Dec., Steady speed section.
- If continuous operation command is executed in operation, the current operation step no. is changed to the next step no. and keep operating.
- There are differences of operation depending on between absolute coordinates and relative coordinates.

(2) Operation timing

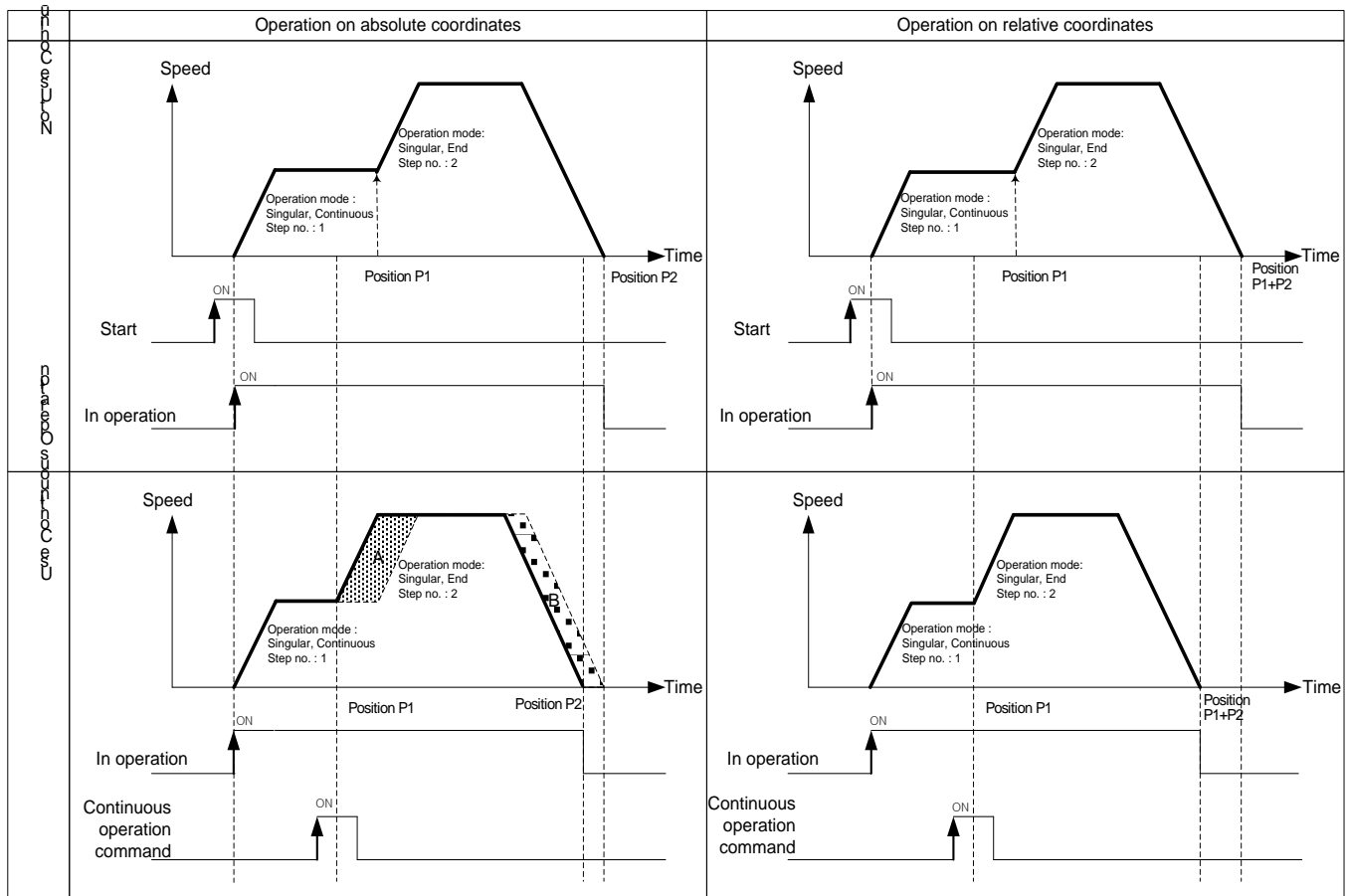

- The goal positions of continuous operation on absolute coordinates are same, so the goal position is the same as the position before and after continuous operation. Therefore, the current position positioned by continuous operation is P2. (A area and B area both are same size)
- When continuous operation is executed on relative coordinates, the movement amount between current position and goal position is the real goal position. Therefore, the goal position is different from the one without continuous operation. The position positioned by continuous operation is P1 + P2.

Chapter 8 Functions

(3) Restrictions

In the cases below, continuous operation is not executed and previous operation is being kept.

- (a) Acc./Dec. pattern of extended parameter is "S-curve operation". (error code : 390)
- (b) It is in dwell. (error code : 392)
- (c) The current control is not single axis position control or linear interpolation. (error code : 393)
- (d) Speed data value of operation step to be executed next is 0 or exceeds the speed limit. (error code : 394)
- (e) Execute continuous operation command on sub axis. (error code : 395)

User has to execute continuous operation command on main axis in linear interpolation.

- (f) Execute continuous operation command on axis in circular interpolation. (error code : 396)
- (g) Execute continuous operation on sub axis in sync. operation. (error code : 397)
- (h) The current operation step no. is the last step(400) of operation data. (error code : 399)
- (i) The current axis in operation is executed by direct start command. (error code : 400)
- (j) The continuous operation of common paramert is "Disabled" (error code : 160)

[Example] Execute continuous operation on axis1 operating by absolute, single axis position control

- Current position of Axis1 : 0
- Setting example in XG-PM
- Operation data of axis1

Step no.	Control method	Operation	Goal position [pls]	Operation speed [pls/s]	Acc. no.	Dec. no.	M code	Dwell time
1	Absolute, single axis position control	Singular, end	1000	1000	No.1	No.1	0	0
2	Absolute, single axis position control	Singular, end	5000	2000	No.1	No.1	0	0

■ Operation pattern

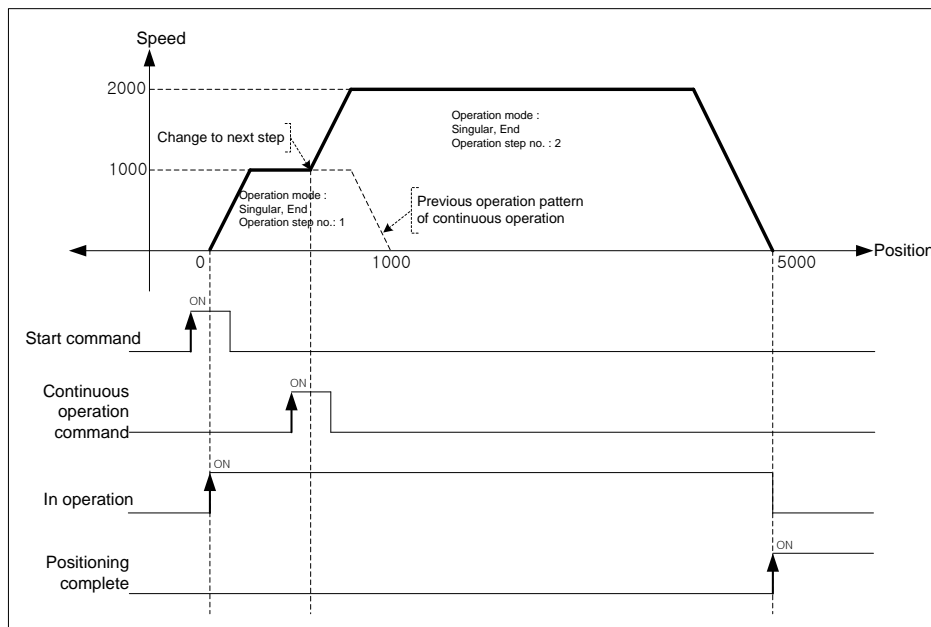

8.5.3 Skip Operation

Decelerate and stop the current operation step and change to the operation data of next operation step no., then execute positioning control.

(1) Characteristics of Control

- SKIP operation command stops the operation and carries out the operation of next step after executing the command other than Continuous operation command (Next Move).
- This is used in case that the operation mode is End, Keep, Continuous and the operation pattern is in Acceleration, Constant speed, Deceleration section.
- If SKIP operation command is executed in the status that the operation data of next step is not yet set, Error 151 will occur.
- When set position data, there would be differences on skip operation command depending on absolute coordinates and relative coordinates,

(2) Operation timing

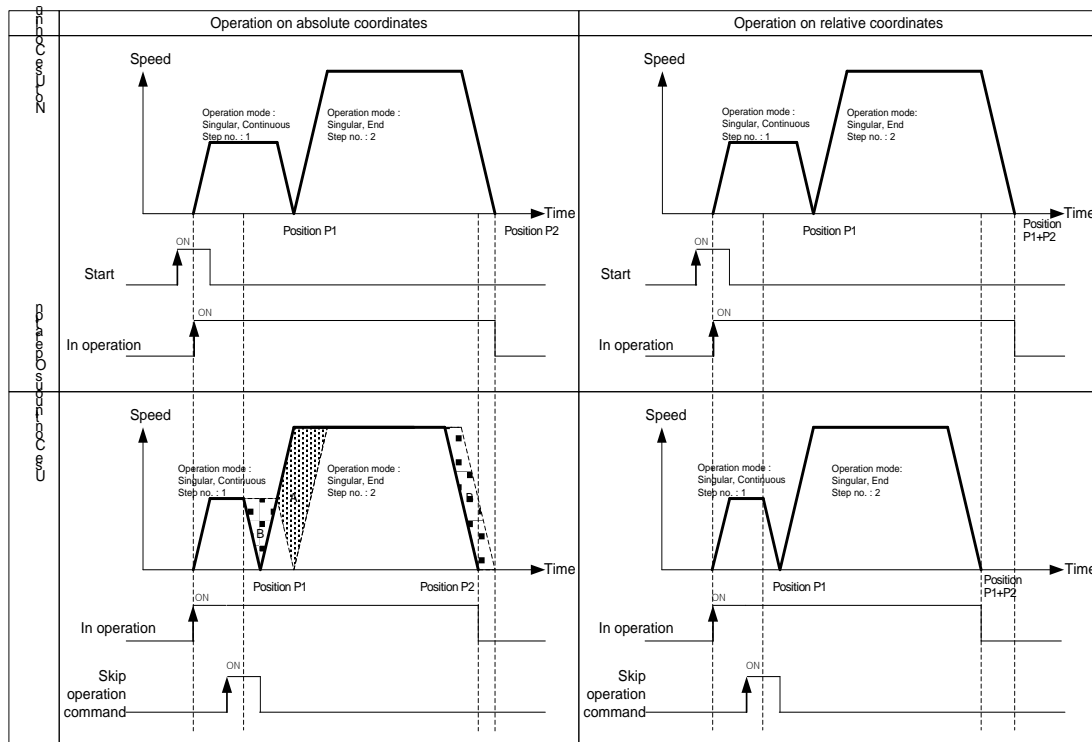

- The goal position of next operation step after skip operation command is executed on absolute coordinates is the same as the case did not execute skip operation. Therefore, current position positioned by skip operation is P2. (A area and B area both are same size)
- When skip operation is executed on relative coordinates, the movement amount between current position and goal position is the real goal position. Therefore, the goal position is different from the one without continuous operation. The position positioned by skip operation is P1 + P2.

Chapter 8 Functions

(3) Restrictions

In the cases below, skip operation is not executed and previous operation is being kept.

- (a) Execute skip operation command on the sub axis of linear interpolation. (error code:332)
Skip operation in linear interpolation operation must be executed on main axis.
- (b) Execute skip operation command on the sub axis of sync. operation. (error code:333)
- (c) Execute skip operation command on the axis in Jog operation. (error code:335)
- (d) The current axis is executed by direct start. (error code:336)
- (e) Execute skip operation on the axis in Inching operation. (error code:337)
- (f) Execute skip operation on the sub axis of circular interpolation. (error code:338)
Skip operation in circular interpolation operation must be executed on main axis.

[Example] Execute skip operation command on axis1 operating by absolute and single axis position control.

- Current position of axis 1 : 0
- Setting example in XG-PM
 - Operation data of axis1

Step no.	Control method	Operation method	Goal position [pls]	Operating speed [pls/s]	Acc.no.	Dec.no.	M code	Dwell time
1	Absolute, Single axis position control	Singular,End	1000	1000	No.1	No.1	0	0
2	Absolute, Single axis position control	Singular,End	5000	2000	No.1	No.1	0	0

■ Operation pattern

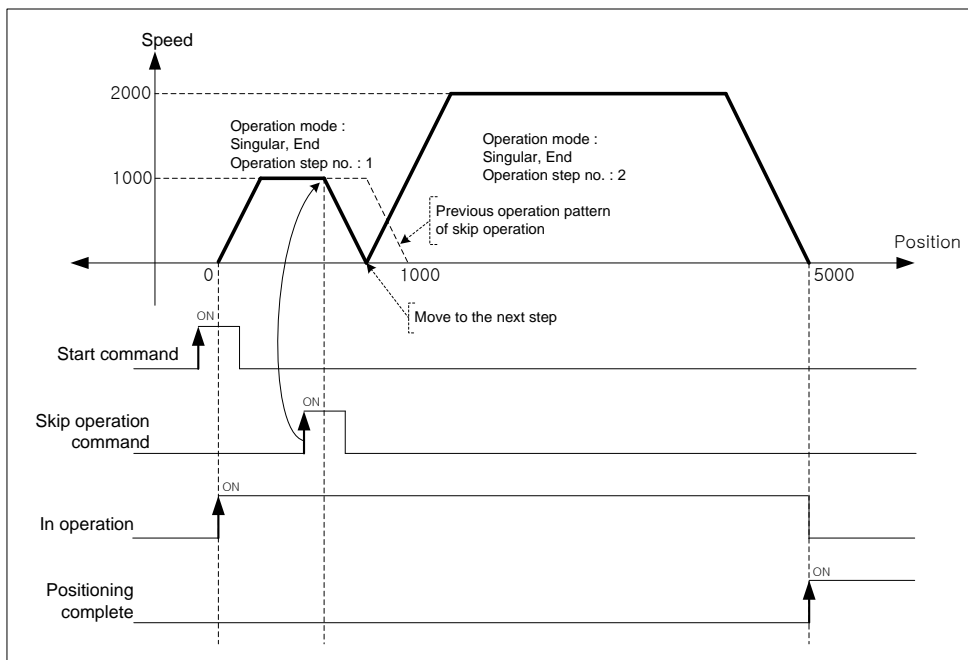

8.5.4 Position Override

This is used to change the goal position during positioning operation by positioning data.

(1) Characteristics of Control

- (a) Position override command is used in the operation pattern (Acceleration, Constant speed, Deceleration section) and the available operation mode is End operation, Keep operation, Continuous operation.
- (b) Position setting range is $-2147483648 \sim 2147483647$ Pulse.
- (c) As the operation is different according to Position Override command during operation, cares should be taken in using.
In other words, if position of position override at the moment of commanding position override is bigger than the position it stopped at, the positioning direction would be forward. If it is smaller, the direction would be reverse.
- (d) This command may be executed several times in operation.

(2) Operation timing

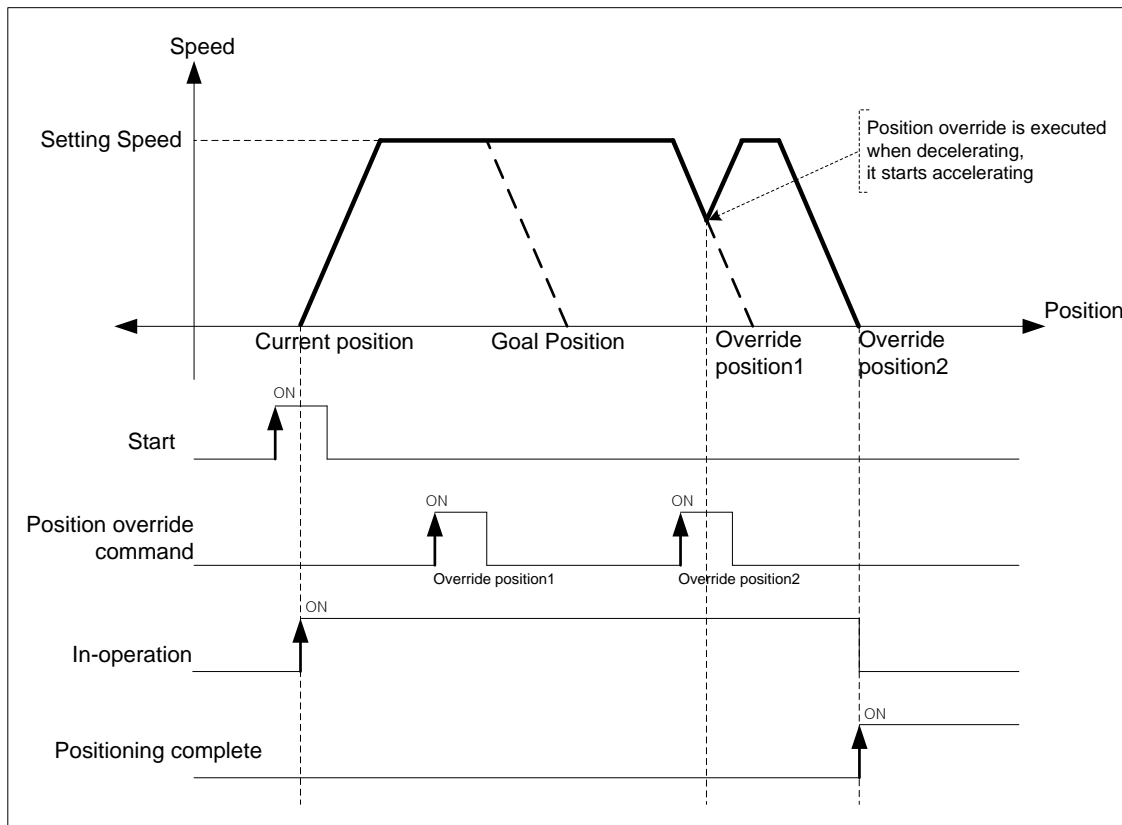

If position override is executed in operation, the goal position is changed to override position1 and keep operating. If position override for override position2 is executed at dec. area, positioning is finished by acc. speed already set at override position2.

Chapter 8 Functions

- The case that override position is smaller than decelerating stop position.

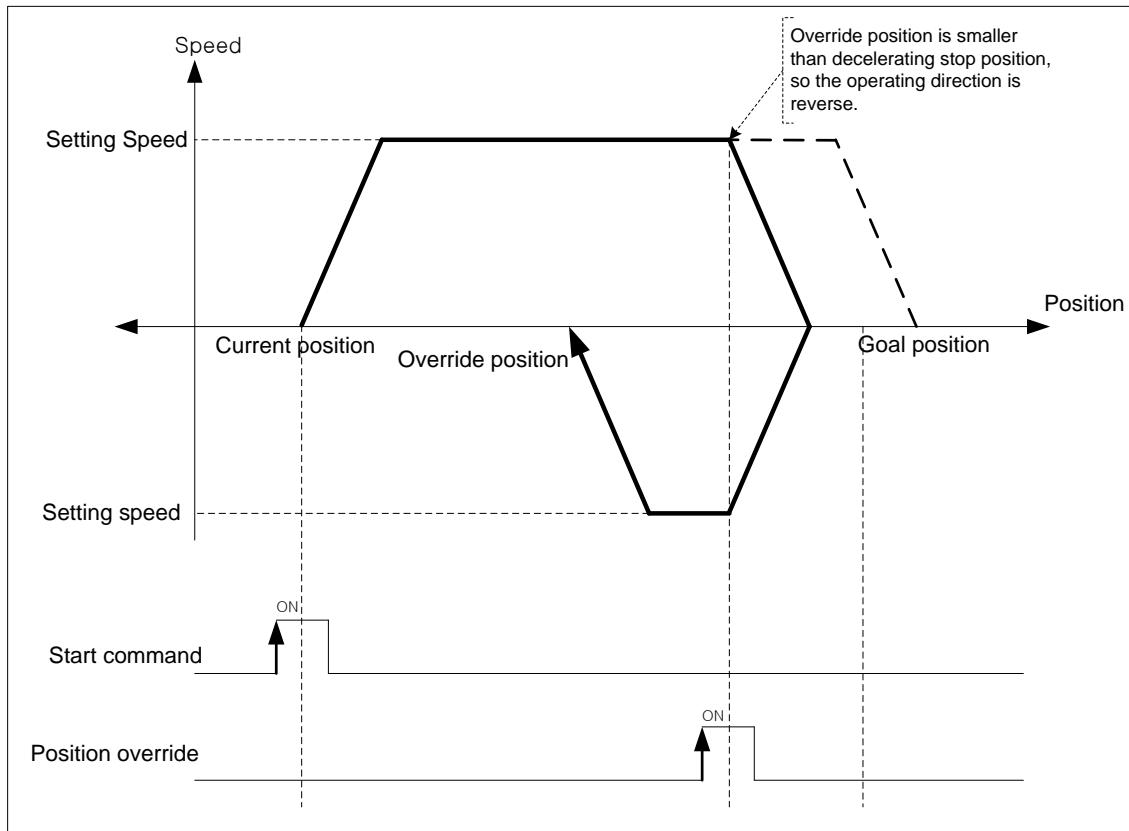

(3) Restrictions

In the cases below, position override is not executed and previous operation is being kept.

- Execute position override in dwell. (error code:362)
- Current operation is not positioning control(single axis positioning, Inching operation). (error code:363)
- Execute position override on the axis operating linear interpolation. (error code:364)
- Execute position override on the axis operating circular interpolation. (error code:365)
- Execute position override on the sub axis of sync. operation. (error code:366)

[Example] Execute position override on axis1 operating by absolute, single axis position control.

- Current position of axis1 : 0

- Setting example in XG-PM

- Operation data of axis1

Step no.	Control method	Operation method	Goal position [pls]	Operation speed [pls/s]	Acc.no.	Dec.no.	M code	Dwell time
1	Absolute single axis position control	Singular, End	1000	1000	No.1	No.1	0	0
2	Absolute single axis position control	Singular, End	5000	2000	No.1	No.1	0	0

- Operation pattern

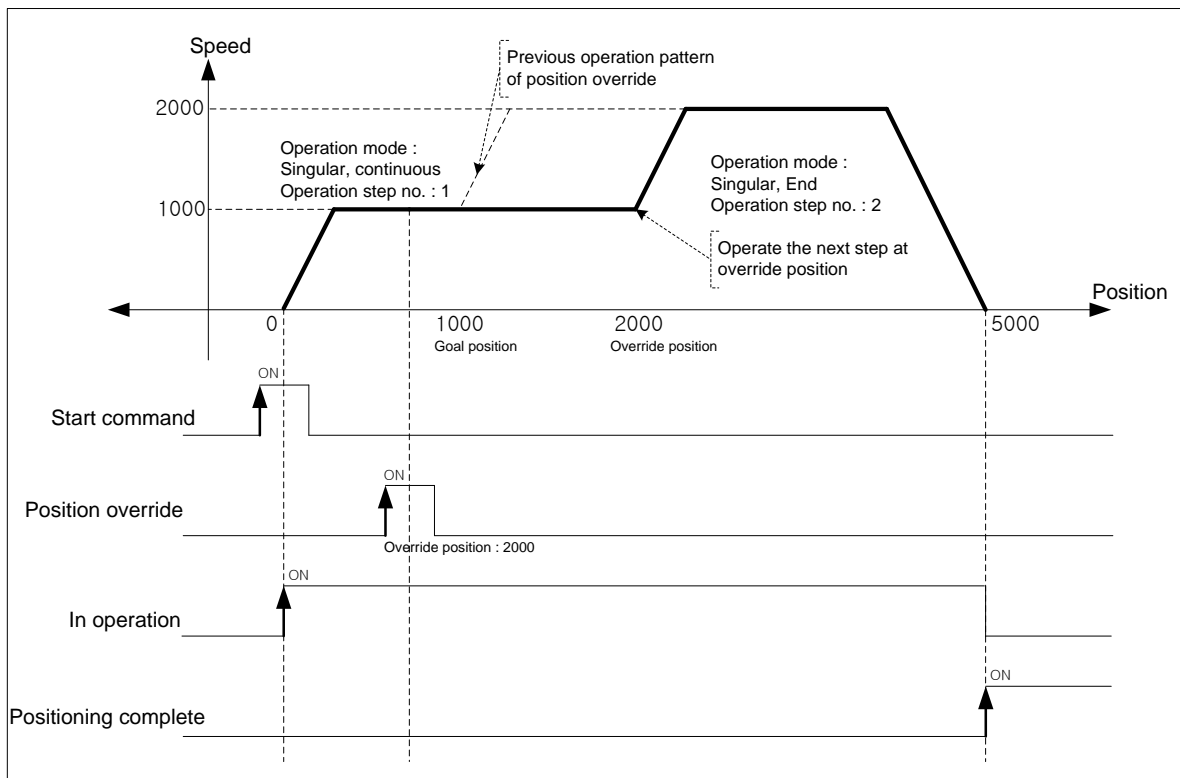

Note

If operation pattern is "continuous" and override position is bigger than goal position, keep operating at current speed then continue to operate the next step. If override position is smaller than goal position, execute decelerating stop and position in reverse direction, then continue to operate the next step.

Chapter 8 Functions

8.5.5 Speed Override

When user wants to change the operation speed of positioning control, user may change the speed with speed override command.

(1) Characteristics of Control

- (a) Speed override command is available in acc./steady speed area and available operation modes are “end”, “go on” and “continuous”.
- (b) It may be executed several times in operation.
- (c) User may set speed override value as “%setting” or “speed setting” on [Speed override] of common parameter.
- (d) Related parameter setting (common parameter)

Items	Setting value	Description
Speed override	0 : %setting	Set the speed override setting value by %
	1 : speed setting	Set the speed override setting value with exact number

(e) Auxiliary data of speed override command setting

Items	Setting value	Description
Speed	1 ~ 65535 (1=0.01%)	Set the speed override setting value with percentage (If it is 100%, set 10000)
	1 ~ Speed limit	Set the speed override setting value directly

(2) Operation timing

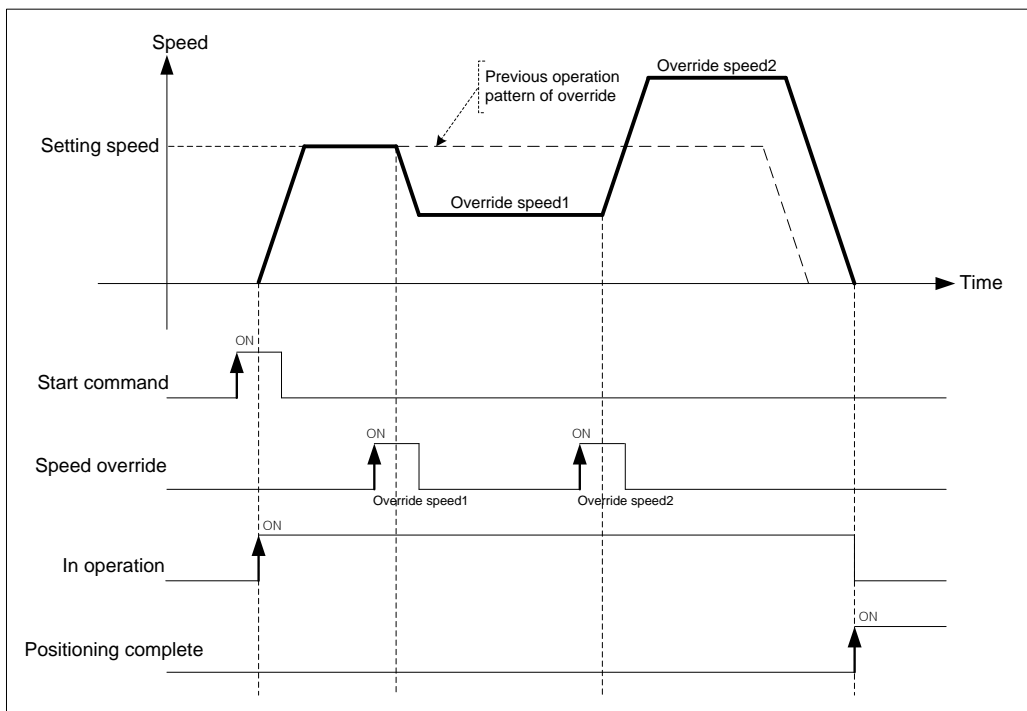

현재 운전 중인 위치결정 제어의 운전 속도를 변경하고자 하는 경우에 속도 오버라이드 명령을 사용하여 운전 속도를 변경할 수 있습니다.

(3) Restrictions

In the cases below, speed override is not executed and previous operation is being kept.

- Value of speed override exceeds speed limit of basic parameter. (error code:372)
Speed value of Speed override must be below speed limit.
Override speed of linear interpolation for each axis need to be below speed limit.
- Execute speed override on the sub axis of linear interpolation. (error code:373)
In linear interpolation, speed override must be executed on main axis.
- Execute speed override on the sub axis of circular interpolation. (error code:374)
In circular interpolation, speed override must be executed on main axis.'
- Execute speed override on sub axis of sync. operation. (error code:375)
- Execute speed override in dec. area. (error code:377)
- In the case that acc./dec. pattern of extended parameter is "S-curve operation". (error code:378)

[Example] Execute speed override(50%→100%→200%→150%) on axis1 operating by absolute, single axis position control.

- Current position of axis1 : 0
"Speed override" of common parameter : Set %
"Speed limit" of basic parameter : 3000 [pls/s]

■ Setting example of XG-PM

▪ Operation data of axis1

Step no.	Control method	Operation method	Goal position [pls]	Operation speed [pls/s]	Acc.no.	Dec.no.	M code	Dwell time
1	Absolute, single axis position control	Singular, End	1000	2000	No.1	No.1	0	0

■ Operation pattern

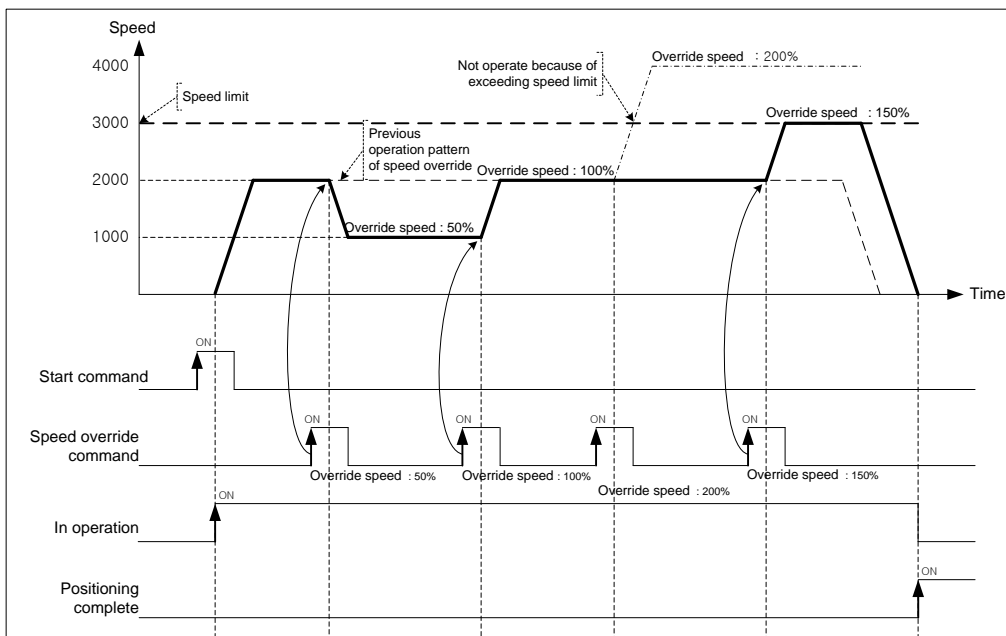

Chapter 8 Functions

8.5.6 Position designated Speed Override

This is the command to operate by the changed operation speed if it reaches the setting position during positioning operation.

(1) Characteristics of Control

- (a) This command is used only in Acceleration and Constant speed section from operation pattern and the available operation mode is End, Keep, Continuous operation.
- (b) As this command is not carried out in Deceleration section, cares should be taken in using.
- (c) The position setting range is $-2147483648 \sim 2147483647$ Pulse.
- (d) User may set speed override value as “%setting” or “speed setting” on [Speed override] of common parameter.
- (e) User may select that consider the designated position value on “coordinates of positioning speed override” of extended parameter as an absolute position or a relative position.
- (f) Related parameter setting

■ Common parameter

Items	Setting value	Description
Speed override	0 : Set %	Set the value of speed override by %
	1 : Set speed	Set the value of speed override with exact number

■ Extended parameter

Items	Setting value	Description
Coordinates of positioning speed override	0 : Absolute	Speed override is executed in the designated absolute position
	1 : Relative	Start speed override from the position increment added

(g) Auxiliary data setting of positioning speed override command

Items	Setting value	Description
Position	$-2147483648 \sim 2147483647$	Set the position to start speed override
Speed	1 ~ 65535 (1=0.01%)	If speed override is “%”, set the speed by % (100% is 10000)
	1 ~ Speed limit	If speed override is “Exact number”, set the speed with exact number

Note

While the current position is not exactly same as the value set on speed override, if the position of speed override is at between previous scan and current scan, speed override is executed at the speed set.

(2) Operation timing

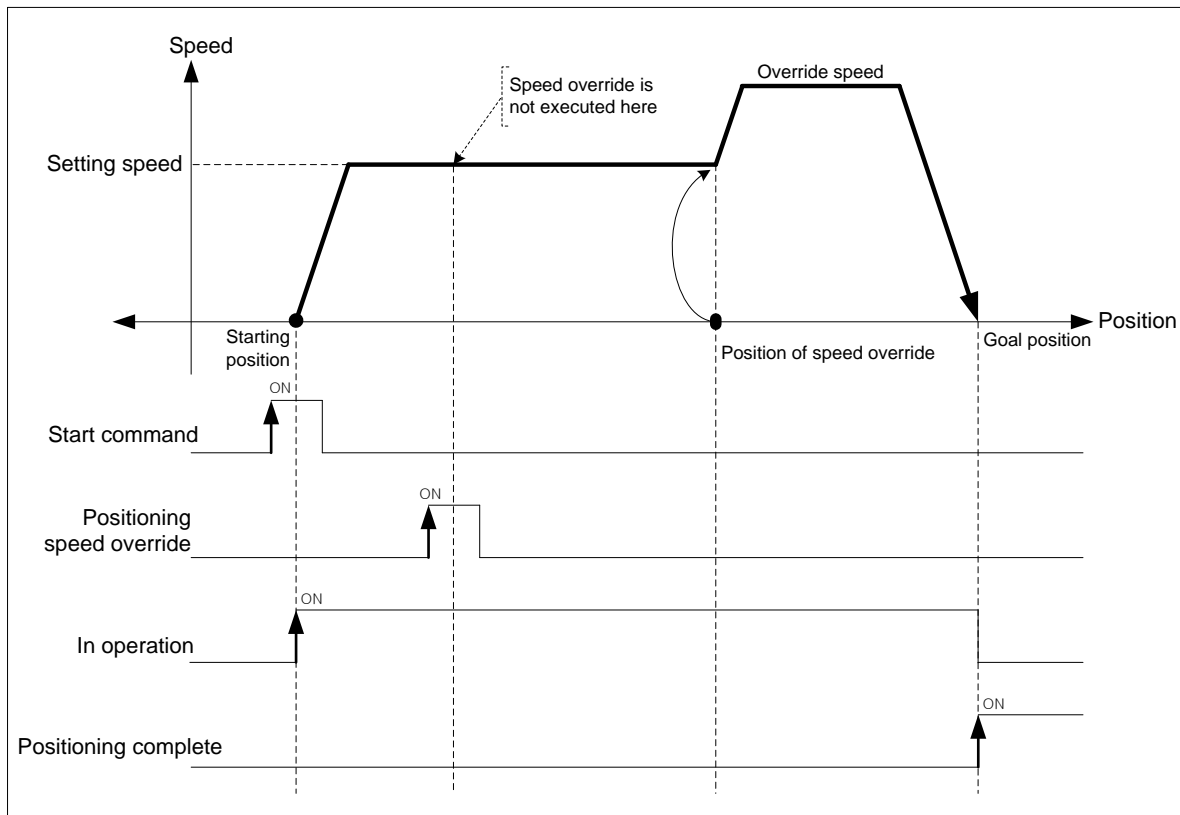

(3) Restrictions

In the cases below, positioning speed override is not executed and previous operation is being kept.

- (a) Current operation is not positioning (single axis position control, Inching operation) control. (error code:382)
- (b) The value of speed override exceeds speed limit of basic parameter. (error code:383)
The speed value of speed override must be below speed limit.
Override speed of linear interpolation for each axis need to be below speed limit.
- (c) Execute positioning speed override on the sub axis of linear interpolation. (error code:384)
In linear interpolation, positioning speed override must be executed on main axis.
- (d) Execute speed override on the sub axis of circular interpolation. (error code:385)
In circular interpolation, positioning speed override must be executed on main axis.
- (e) Execute speed override on sub axis of sync. operation. (error code:386)
- (f) In the case that acc./dec. pattern of extended parameter is "S-curve operation". (error code:389)
- (g) If execute positioning speed override in dec. area., although error does not arise but speed override is not executed. However, execute positioning speed override command in non-dec. area and speed override is executed when it is decelerating, error arises. (error code:377)

Chapter 8 Functions

[Example] Execute positioning speed override at 4000 [pls/s] at 2000(position of speed override) on axis1 operating by absolute, single axis position control.

- Current position of axis 1 : 0
 - 「Speed override」 of common parameter : Speed setting
 - 「Speed limit」 of basic parameter : 5000 [pls/s]
 - 「Coordinates of positioning speed override」 of extended parameter : Absolute

■ Setting example in XG-PM

▪ Operation data of axis1

Step no.	Control method	Operation method	Goal position [pls]	Operation speed [pls/s]	Acc.no.	Dec.no.	M code	Dwell time
1	Absolute single axis position control	Singular, End	5000	2000	No.1	No.1	0	0

■ Operation pattern

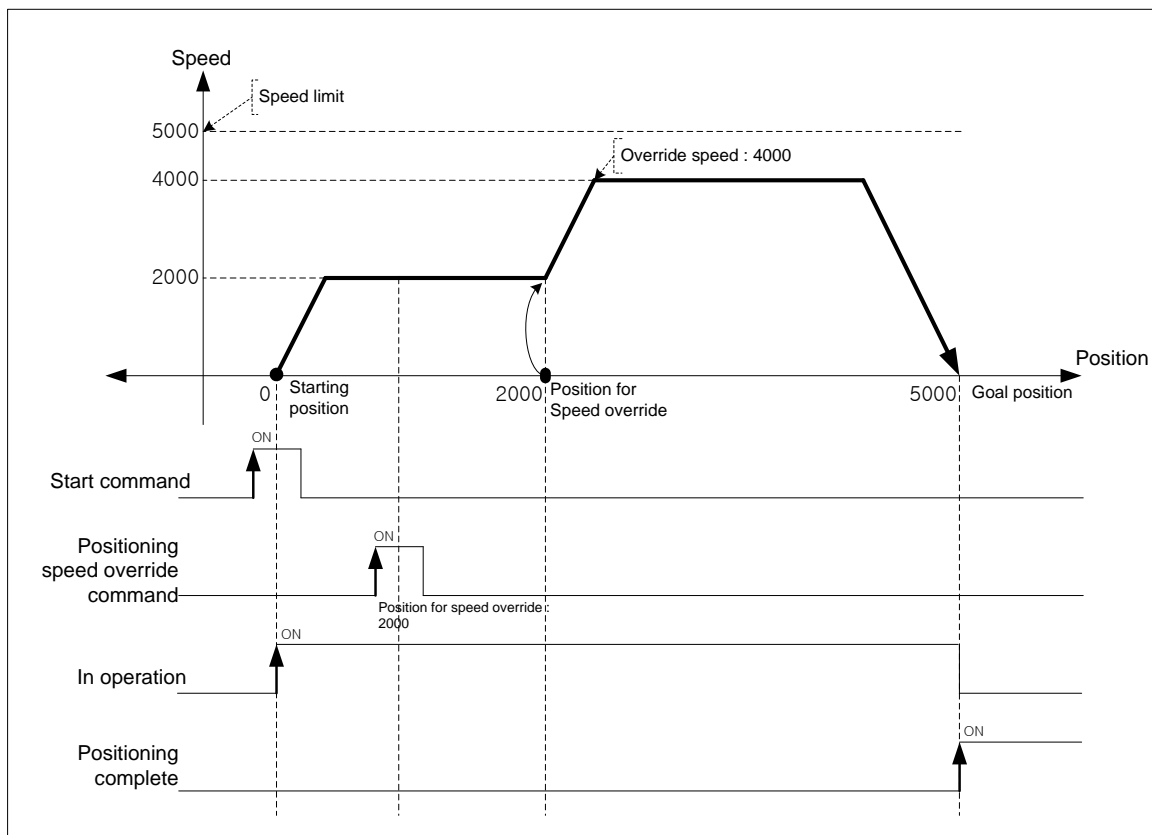

8.5.7 Current Position Preset

This command is for changing the current position value to the value at user's pleases.

(1) Characteristics of Control

- If user uses this command, the origin-undecided status becomes origin-decided status.
- When the current position is changed by position changing command, the mechanical origin position is changed. If user wants to use the mechanical origin again, has to execute homing command.
- The current position preset command may not be executed in operation.
- Auxiliary data setting of current position preset command.

Items	Setting value	Description
Position	-2147483648 ~ 2147483647	Set the position to change

(2) Operation timing

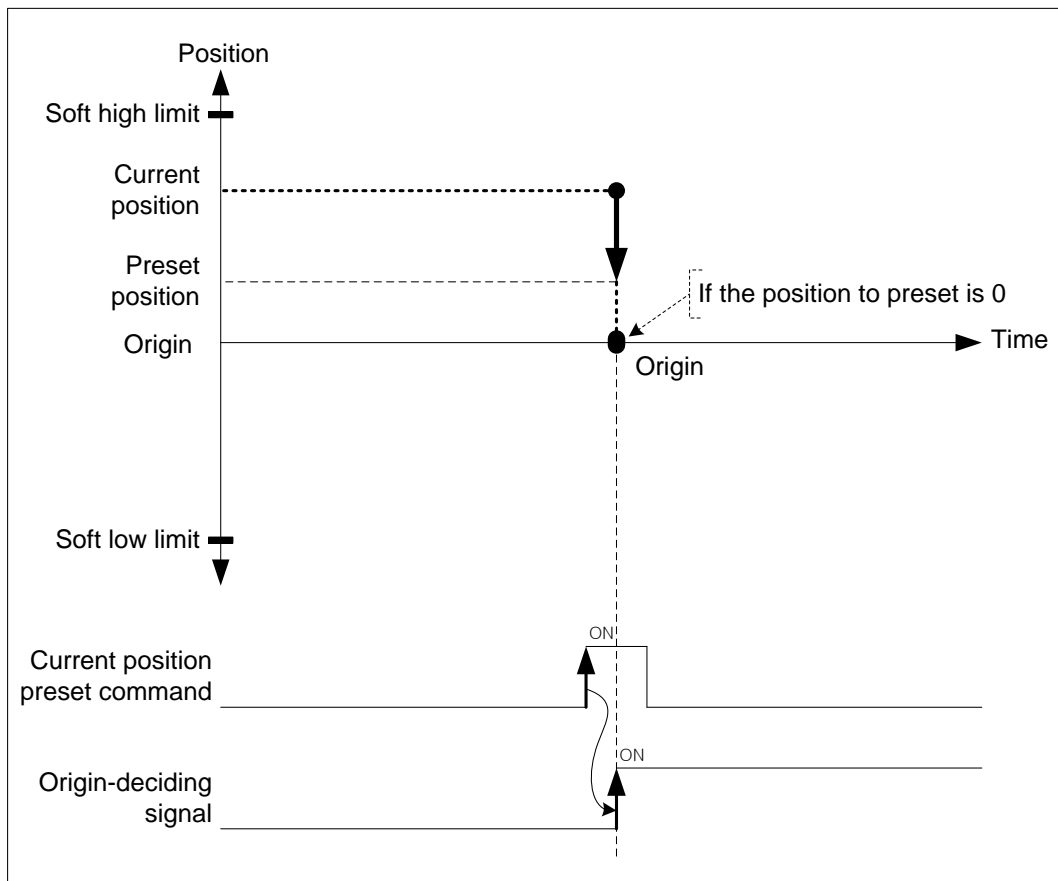

(3) Restrictions

In the cases below, current position preset is not executed and error arises.

- Setting value of current position preset exceeds soft high/low limit of extended parameter. (error code:452)

Chapter 8 Functions

8.5.8 Encoder Preset

This command is for changing the value of current encoder position to the value at user's pleases.

(1) Characteristics of Control

- (a) User may change the current position value.
- (b) If there is an encoder being main axis, the speed of sub axis is possible to be changed dramatically, so encoder preset command may not be executed.
- (c) Encoder preset command should be executed in the status that external encoder pulse input is not entered.
- (d) Auxiliary data setting of encoder preset command

Items	Setting value	Description
Position	-2147483648 ~ 2147483647	Set the encoder position to change on selected encoder
Types	0 : Encoder	Select encoder to change (Must be 0)

(2) Operation timing

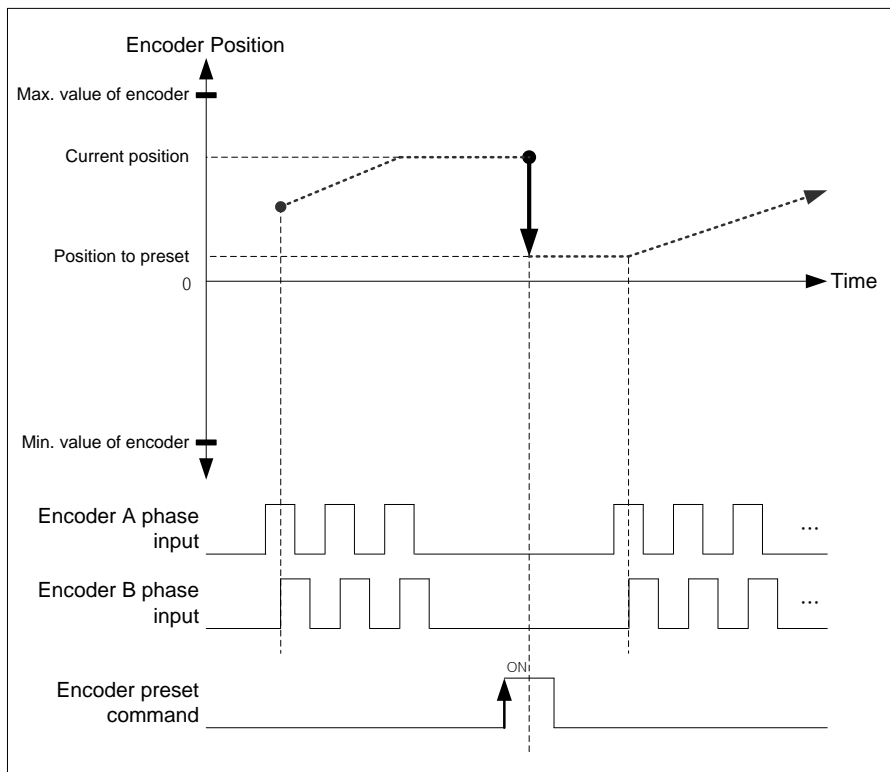

(3) Restrictions

In the cases below, encoder preset command may not be executed and error arises.

- (a) There is an encoder as a main axis (error code: 532)
- (b) Position value of encoder preset exceeds the max./min. value of encoder of common parameter. (error code:534)

8.5.9 Start Step no. Change

This command is for changing the current step no. when executing indirect start command.

(1) Characteristics of Control

- (a) When starting with setting step no. as 0 in indirect start command, current operation step no. is executed. The current step no. may be changed by start step no. change command.
- (b) This command may be only executed in stop motion or error arises.
- (c) Auxiliary data setting of start step no. change command.

Items	Setting value	Description
Step	1 ~ 400	Set the step no. to change

(2) Operation timing

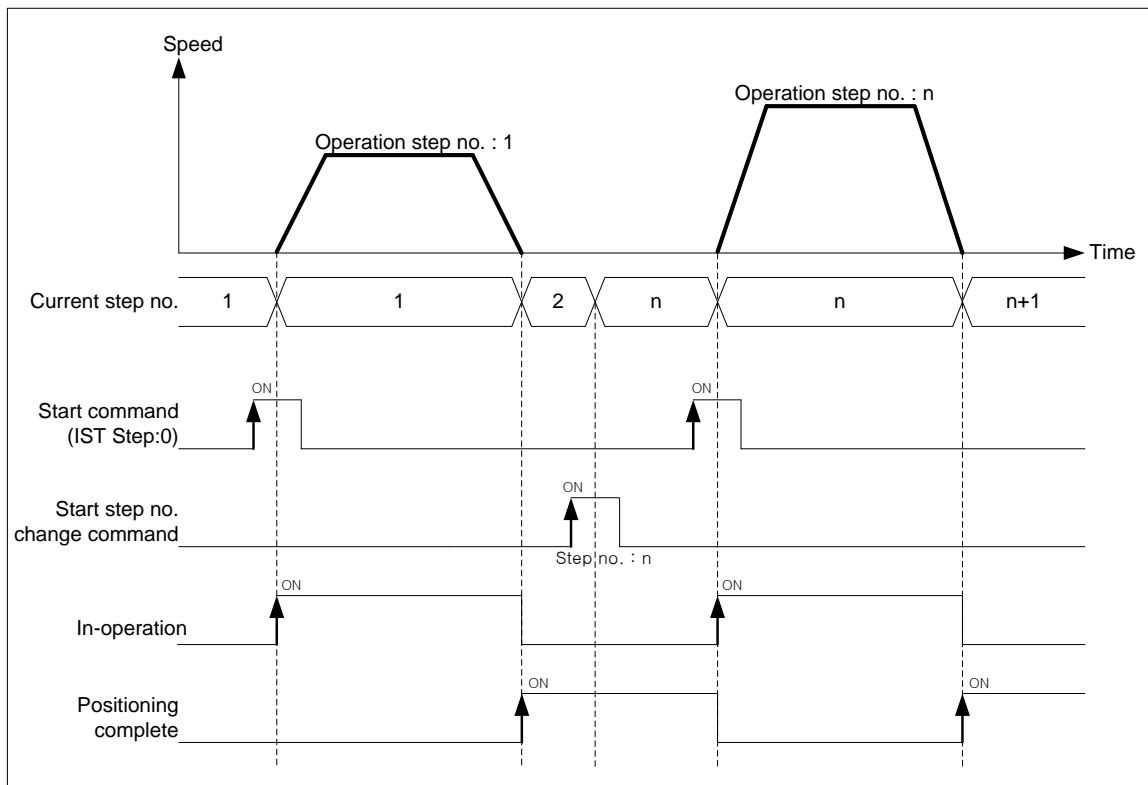

(3) Restrictions

In the case below, start step no. change command is not executed.

- (a) Step no. to change is out of 0 ~ 400. (error code:442)
If step no. is 0, keep the current step no.

Chapter 8 Functions

8.5.10 Repeat Operation Step no. Change

This command is for changing the repeat operation step no will be executed next.

(1) Characteristics of Control

- In case of repeat operation mode setting (End, Keep, Continuous operation), the current operation step no. will be changed automatically to operate the step no.1 when repeat operation mode setting step completes the positioning operation but if start step no. change command is executed in repeat operation, the step no. will be changed with the assigned step no. not the step no.1 .
- The repeat operation step no. change command can be executed during positioning operation.
- Auxiliary data setting of repeat operation step no. change command

Items	Setting value	Description
Step	1 ~ 400	Set the repeat operation step no. to change

(2) Operation timing

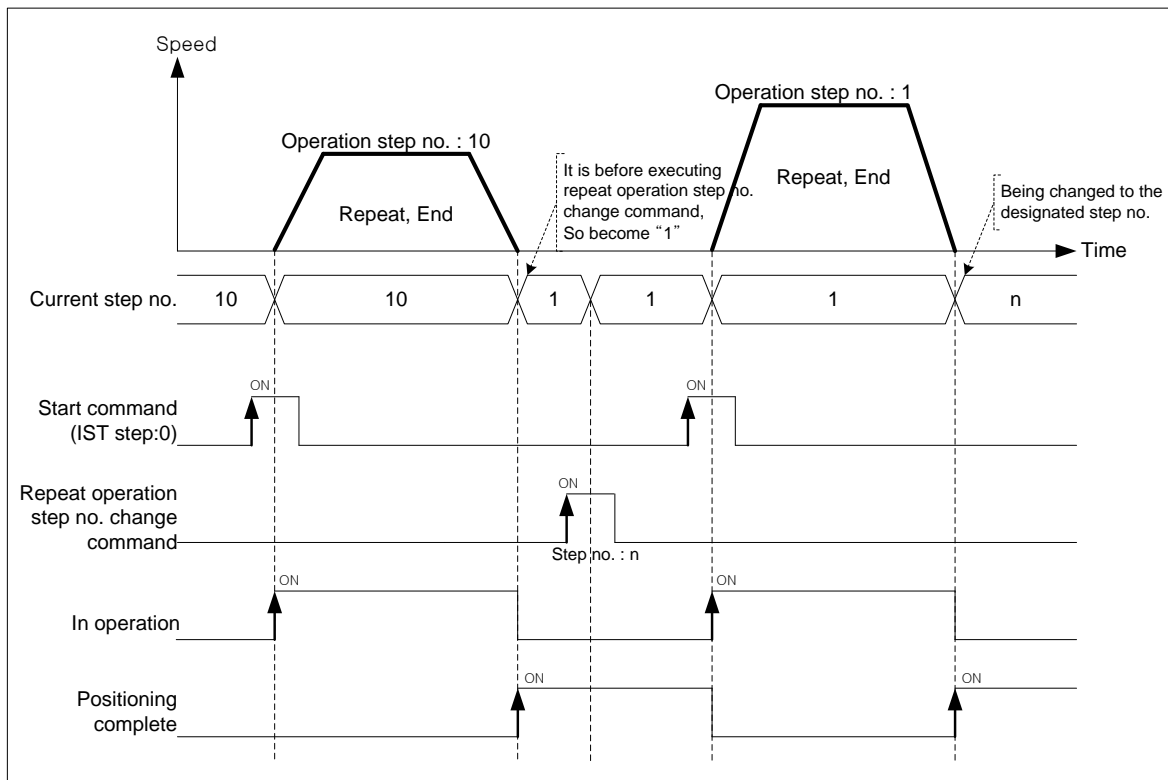

Note

The current operation step is not changed at the moment of executing the command. After "Repeat" positioning data operation is finished, it is changed to the step designated by repeat operation step no. change command.

(3) Restrictions

In the case below, repeat operation step no. change command is not executed.

(a) Step no. to change is out of 0 ~ 400. (error code:442)

If the step no. is 0, keep the previous step no.

[Example] Execute repeat operation step no. change command on axis1 operating by absolute, single axis position control.

- Current position of axis1 : 0
- Setting example in XG-PM
- Operation data of axis1

Step no.	Control method	Operation method	Goal position [pls]	Operation speed [pls/s]	Acc. no.	Dec. no.	M code	Dwell time
1	Absolute single axis position control	Singular, Go on	1000	1000	No.1	No.1	0	0
2	Absolute single axis position control	Singular, continuous	2000	2000	No.1	No.1	0	0
3	Absolute single axis position control	Singular, continuous	4000	3000	No.1	No.1	0	0
4	Absolute single axis position control	Repeat, Continuous	2000	3000	No.1	No.1	0	0
5	Absolute single axis position control	Singular, End.	5000	2000	No.1	No.1	0	0

■ Operation pattern

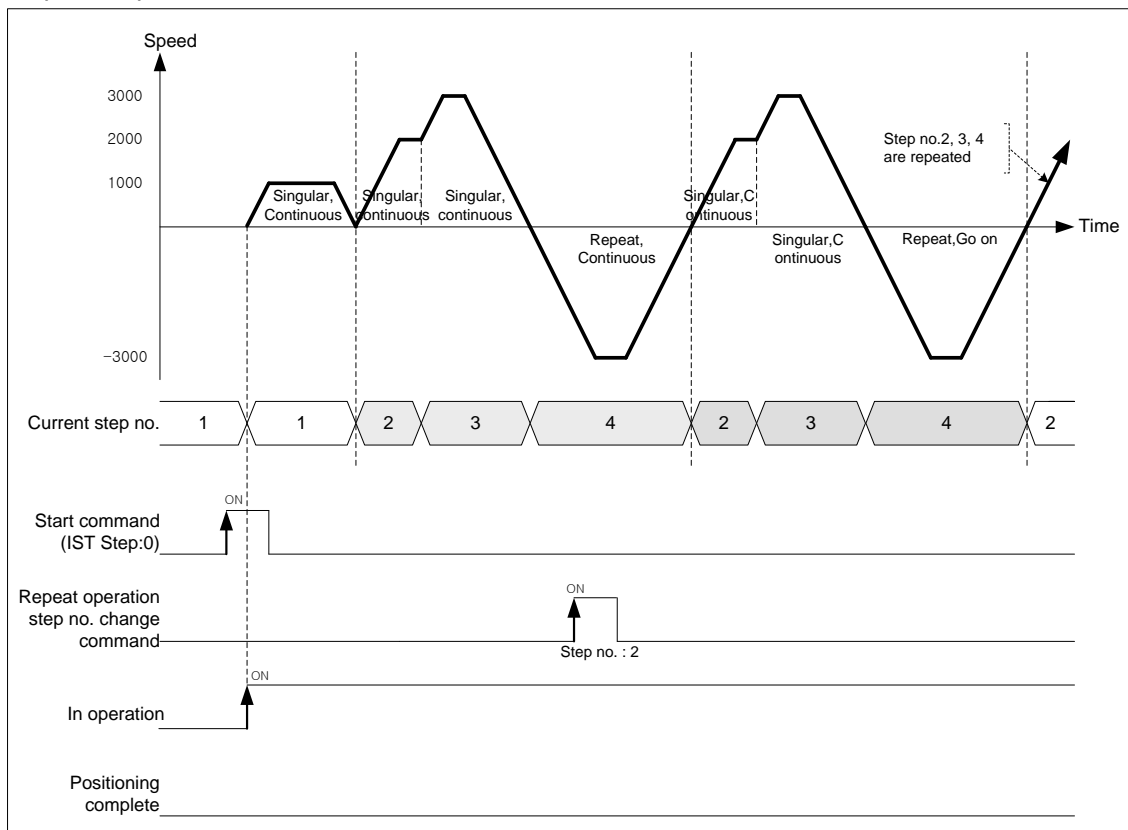

8.6 Auxiliary Function of Control

8.6.1 High/Low limit

Positioning module includes Hardware high/low limit and Software high/low limit.

(1) Hardware High/Low Limit

- This is used to stop the positioning module promptly before reaching Stroke limit/Stroke End of the Driver by installing the stroke limit of positioning module inside Stroke limit/Stroke end of the Driver. In this case, if it is out of the high limit, Error 492 will occur and if it is out of the low limit, Error 493 will occur.
- Input of high/low limit switch is connected to input/out terminal block.
- When positioning module is not in the controllable area, positioning operation is not executed.
- If it is stopped by hardware high/low limit detection, move it into the controllable area with Jog operation in reverse direction of detected signal.
- Hardware high/low limit is shown as follows.

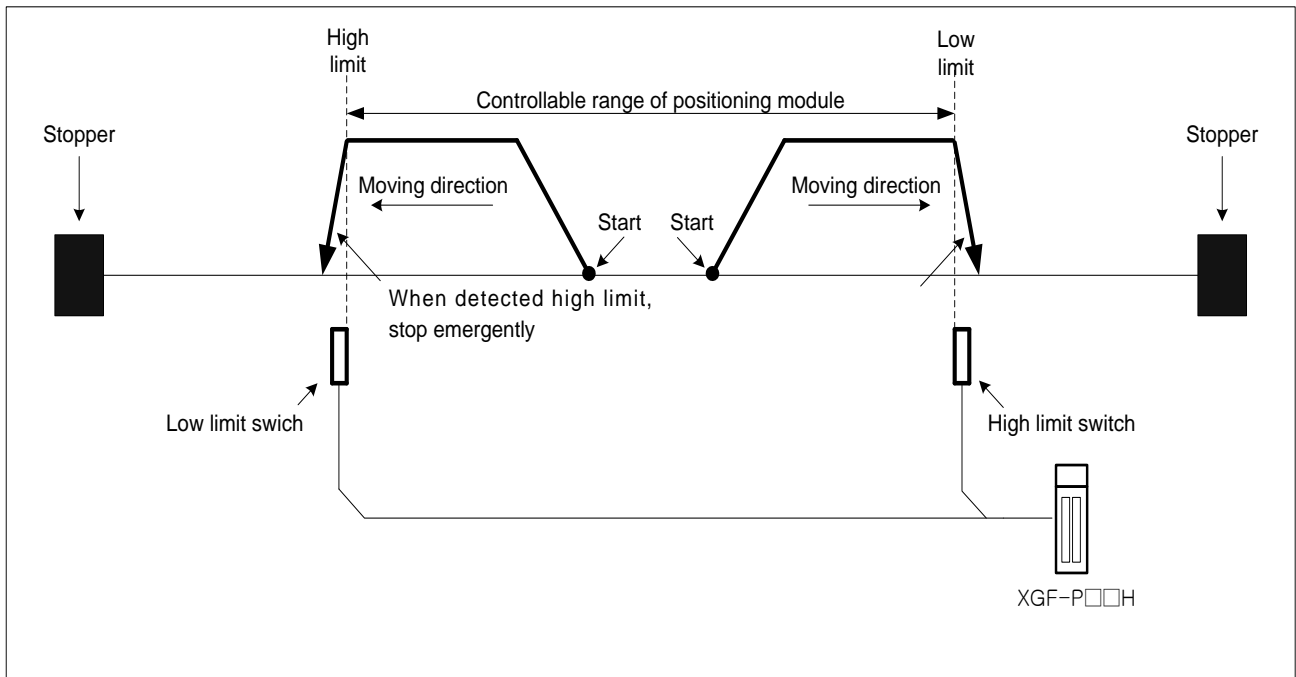

(f) Emergent stop when hardware high/low limit is detected

When hardware high/low limit is detected, stop the current positioning control and then decelerate within "Dec. time for Emergent stop".

■ Related parameter setting (Basic parameter)

Items	Setting value	Description
Dec. time of Emergent stop	0 ~ 2147483647 [ms]	Set the dec. time for emergent stop. Dec. time for emergent stop means the time needed at decelerating by bias speed.

(2) Software High/Low Limit

- (a) This command is for setting the movable range of machine as software high/low limit. If it is out of the range in operation, stop emergently within dec. time for emergency. In other words, this command is for preventing errors, malfunctions and being out of range.
- (b) If it is out of the range of software high/low limit, set external input high/low limit for use.
- (c) Checking range of software high/low limit is executed at the beginning.
- (d) If software high/low limit is detected, error arises. (High limit error:501, Low limit error:502)
- (e) User may set the position value of high/low limit on extended parameter.

■ Related parameter setting (Extended parameter)

Items	Setting value	Description
Soft High Limit	-2147483648 ~ 2147483647	Set the position of soft high limit
Soft Low Limit	-2147483648 ~ 2147483647	Set the position of soft low limit

- (f) Software high/low limit is shown as follows.

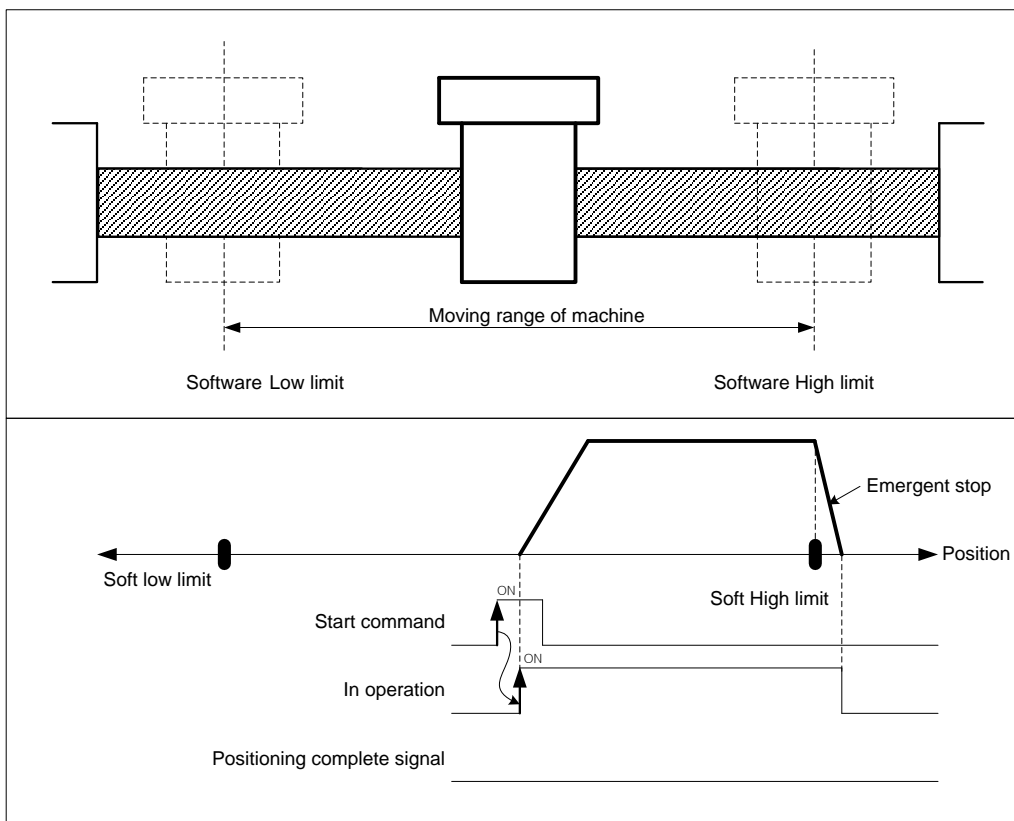

- (g) In the case below, software high/low limit are not detected.

- The value of soft high limit 2147483647, the value of soft low limit is -2147483648
- The value of soft high and low limit are same. (High limit = Low limit)

Chapter 8 Functions

Note

(1) It does not detect software high/low limit in origin-undecided state

(2) Not to detect software high/low limit

If the value of current position becomes 2147483647 in forward operation, the current position becomes -2147483646 and keeps operating in forward direction.

If the value of current position becomes -2147483647 in reverse operation, the current position becomes 2147483646 and keeps operating in reverse direction.

8.6.2 M code

This is used to confirm the current operation step no. and carry out the auxiliary work (Clamp, Drill rotation, Tool change etc.) by reading M Code from the program.

(1) Characteristics of Control

- M code should be set in the M code item of operation data.(Setting range : 0~ 65535)
- If M code is set as "0", M code signal will not occur.
- If M code occurs, M code no.(1 ~ 65535) and M code signal (On) will occur simultaneously.
- In case of Keep operation mode, if M code no. and M code signal occur, it becomes standby for the next step; if executing M code release (MOF) command, it carries out Keep operation to the next step without start command.
- In continuous operation mode, even if M code no. and M code On signal occur, not to wait but execute continuous operation to the next step.
- User may turn M code signal off and set M code no. to 0 with M code release command. M code release command can be used even during operation.
- M code mode is set from M code output item of extended parameter. (0 : NONE, 1 : WITH, 2 : AFTER)

■ Related parameter setting (Extended parameter)

Items	Setting value	Description
M code mode	0 : None	Not to output M code signal and M code no.
	1 : With	Start and turn M code signal on at the same time, then output M code no. set in operation data.
	2 : After	After finishing positioning by start command, turn M code signal on and then output M code no. set in operation data.

(2) Operation timing

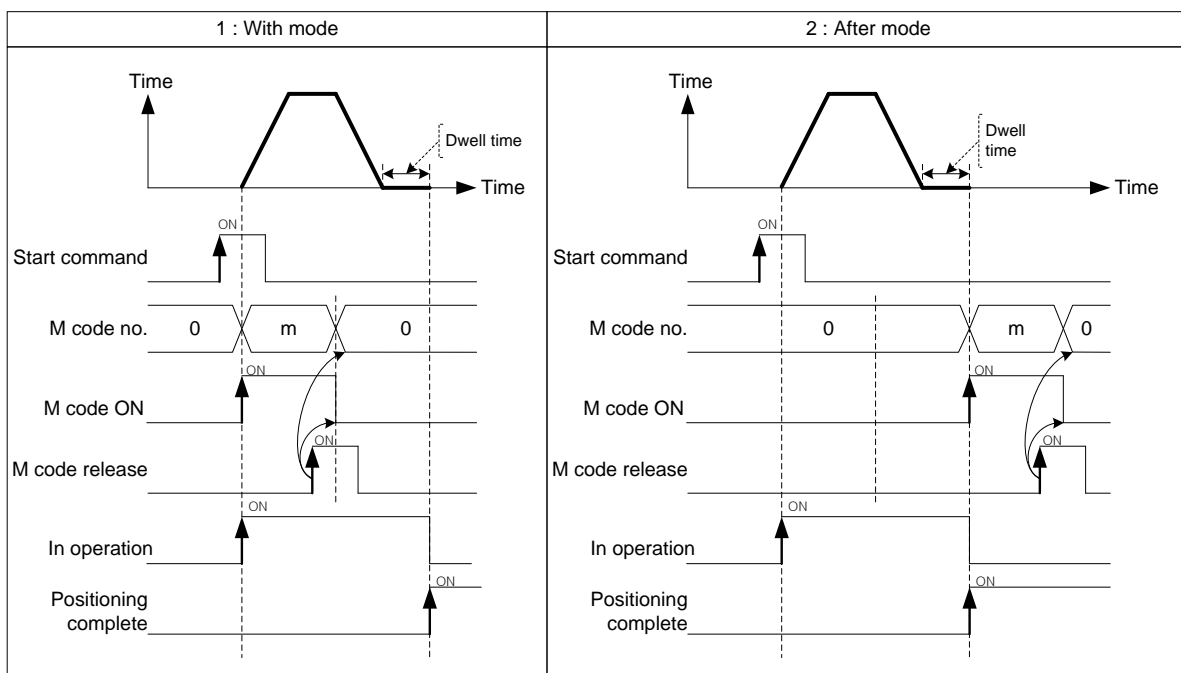

Chapter 8 Functions

[Example] Set M code no. in operation data as follows and execute absolute, single axis positioning control.

- Current position of axis1 : 0
M code mode of basic parameter : With
- Setting example in XG-PM
 - Operation data of axis1

Step no.	Control method	Operation method	Goal position [pls]	Operation speed [pls/s]	Acc. no.	Dec. no.	M code	Dwell time
1	Absolute, single axis positioning control	Singular, continuous	1000	2000	No.1	No.1	100	100
2	Absolute, single axis positioning control	Singular, continuous	3000	2000	No.1	No.1	200	100
3	Absolute, single axis positioning control	Singular, continuous	5000	2000	No.1	No.1	300	100

■ Operation pattern

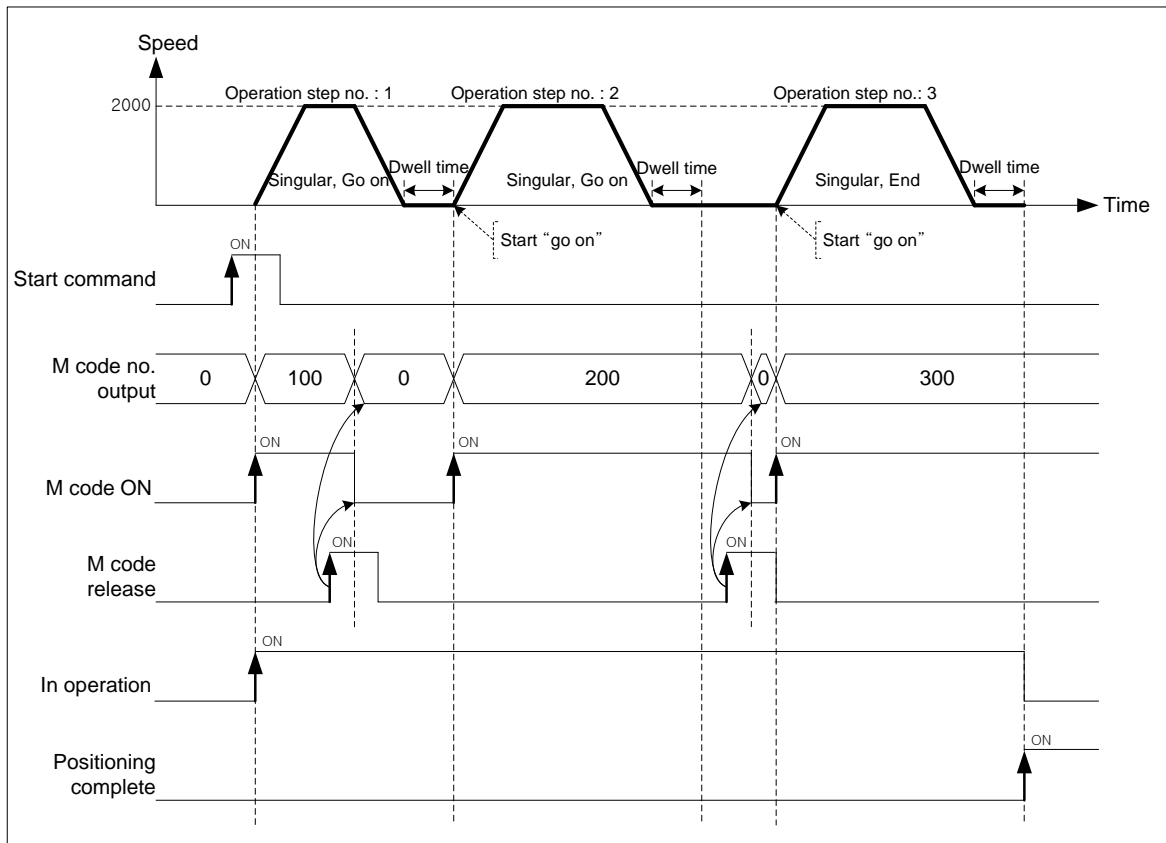

8.6.3 Infinite running repeat function

This is used to repeat operation between "0" and "infinite running repeat position-1". It is activated when the infinite running repeat parameter is "enabled".

(1) Characteristics of Control

(a) infinite running repeat position can be designated between 1~2,147,483,647.

■ Operation pattern

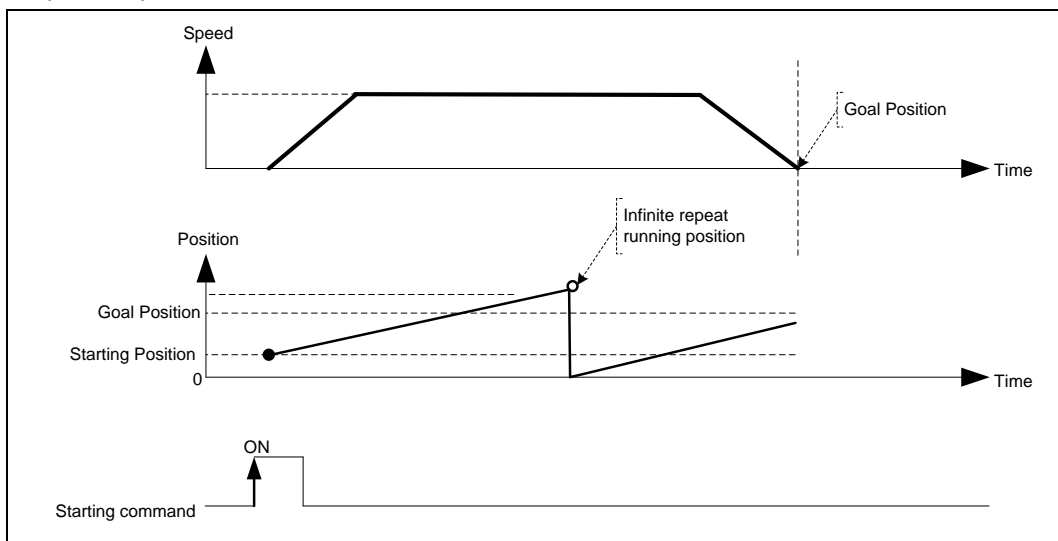

Chapter 8 Functions

8.7 Data Modification Function

This function is for changing operation data and operation parameter of embedded positioning module

8.7.1 Teaching Array

User may change the operating speed and the goal position of the step user designated with teaching command but without XG-PM.

(1) Characteristics of Control

- (a) This command is for changing operating speed or the goal position on several steps.
- (b) User may change maximum 16 data.
- (c) RAM teaching and ROM teaching are available depending on the saving position.
 - RAM teaching
When executing teaching to operation data of module and operating module in power connection, user may change speed value or position value but the speed value and position value are not saved in non-power connection.
 - ROM teaching
When executing teaching to operation data of module and operating module in power connection, user may change speed value or position value and operation data is saved permanently even in non-power connection.
- (d) The value of goal position being changed is position teaching, the value of operating speed being changed is speed teaching.
- (e) The axis in operation may be the subject of position teaching or speed teaching.
- (f) If user changes the value of goal position or operating speed frequently, this command is very useful for it.
- (g) Auxiliary data setting of teaching array command

Items	Setting value	Description
Step	0 ~ 400	Set the step no. for teaching
Position	0 : RAM teaching 1 : ROM teaching	Set the method of teaching
Data	0 : Position 1 : Speed	Set the data items for teaching
The No.	1 ~ 16	Set the number of operating step

- (h) Teaching Array command is available to be executed when the axis is operating. But teaching data of operating step do not apply instantly. Operating step data will apply end of present step operation

Note

The teaching data must be set in the data setting area for teaching array before teaching array command is executed. Refer to the teaching array command XTWR.

(2) Restrictions

Teaching array command may not be executed in the case as follows.

- (a) The number of teaching array is out of the range (1~16). (Error code: 462)
- (b) Teaching step no. is out of the range (1~400). (Error code: 465)

Total number (Teaching step no. + The number of Teaching) must be below 400.

8.7.2 Parameter Change from Program

User may modify the operation parameter set on XG-PM with teaching command for each parameter.

(1) Characteristics of Control

- (a) There are 6 kinds of parameter teaching command. (Basic, Extended, Manual operation, Homing, External signal, common parameter teaching)
- (b) Parameter teaching is not available in operation.
- (c) RAM teaching and ROM teaching are available depending on the saving position.
 - RAM teaching
When executing teaching to operation data of module and operating module in power connection, user may change speed value or position value but the speed value and position value are not saved in non-power connection.
 - ROM teaching
When executing teaching to operation data of module and operating module in power connection, user may change speed value or position value and operation data is saved permanently even in non-power connection.

(2) Basic Parameter Teaching

(a) Change the setting value of designated item from basic parameter of module into teaching data.

(b) Auxiliary data setting of basic parameter teaching command

Item	Setting value		Description	
Teaching data	Refer to "setting range"		Set the teaching value of parameter selected	
			Setting range	
Teaching item	1	Speed limit	1 ~ 2147483647	Choose the parameter item to do execute teaching
	2	Acc.time 1	0 ~ 2147483647	
	3	Acc.time 2		
	4	Acc.time 3		
	5	Acc.time 4		
	6	Dec.time 1		
	7	Dec.time 2		
	8	Dec.time 3		
	9	Dec.time 4		
	10	Emergent Dec.time		
	11	Plse/rotation		
	12	Transferring distance/rotation	1 ~ 200000000	
	13	Unit	0:pulse 1:mm 2:inch 3:degree	
	14	Double precision of unit	0:x1 1:x10 2:x100 3:x1000	
	15	Speed unit	0: unit/time 1: rpm	
	16	Bias speed	1 ~ Speed limit	
	17	Pulse output mode	0:CW/CCW 1:PLS/DIR 2:PHASE	
Teaching method	0 : RAM Teaching 1 : ROM Teaching		Set the teaching method	

For the details about basic parameter items and setting value, refer to "Chapter 4 parameter and operation data".

Chapter 8 Functions

(3) Extended Parameter Teaching

(a) Change the setting value of designated item from extended parameter of module into teaching data.

(b) Auxiliary data setting of extended parameter teaching command

Items	Setting value		Description	
Teaching data	Refer to "Setting range"		Set the teaching value of parameter selected	
			Setting value	
Teaching items	1	Soft high limit	-2147483648 ~ 2147483647	Select the parameter item to execute teaching
	2	Soft low limit	-2147483648 ~ 2147483647	
	3	Backlash compensation	0 ~ 65535	
	4	Positioning complete Output time	0 ~ 65535	
	5	Ratio of S-curve	1 ~ 100	
	6	Circular interpolating position of 2 axes linear interpolation continuous operation	0 ~ 2147483647	
	7	Acc./Dec. Pattern	0 : Trapezoid operation 1 : S-curve operation	
	8	M code mode	0 : None, 1 : With, 2 : After	
	9	Soft high/low limit In speed control	0 : Not to detect 1 : Detect	
	10	Servo reset retention time	1 ~ 5000[ms]	
	11	Positioning method of interpolation continuous operation	0 : Pass the goal position 1 : Pass near position	
	12	Circular interpolation of 2 axes linear interpolating continuous operation	0 : No circular interpolation 1 : Circular interpolating continuous operation	
	13	External emergent/dec. stop	0 : Emergent stop 1 : Dec. stop	
	14	Coordinates of positioning speed override	0 : Absolute 1 : Relative	
	15	Pulse output direction	0: CW, 1: CCW	
	16	Infinite running repeat position	1 ~ 2147483647	
	17	Infinite running repeat enable/disable	0: Disable, 1: Enable	
	18	Speed/Position switching coordinate	0: Incremental 1: Absolute	
	19	Interpolation speed selection	0: Main axis speed 1: Synthetic speed	
Teaching method	0 : RAM teaching 1 : ROM teaching		Set the teaching method	

For the details about basic parameter items and setting value, refer to "Chapter 4 parameter and operation data".

(4) Homing Parameter Teaching

(a) Change the setting value of designated item from homing parameter of module into teaching data.

(b) Auxiliary data setting of homing parameter teaching command

Items	Setting value	Description
Teaching data	Refer to "setting range"	Set the teaching value of parameter selected
		Setting range
Teaching items	1 Position of origin	-2147483648 ~ 2147483647
	2 High speed homing	Bias speed ~ Speed limit
	3 Low speed homing	Bias speed ~ Speed of High speed homing
	4 Acc.time for homing	0 ~ 2147483647
	5 Dec.time for homing	
	6 Dwell time for homing	0 ~ 65535
	7 Origin revision	-2147483648 ~ 2147483647
	8 Restart time for homing	0 ~ 65535
	9 Homing mode	0 : Near Origin/Origin (Off) 1 : Near Origin /Origin (On) 2 : High/Low limit Origin 3 : Near Origin 4 : High speed origin 5 : High/Low limit 6 : Origin
	10 Direction for homing	0 : Forward 1 : Reverse
Teaching method	0 : RAM teaching 1 : ROM teaching	Set the teaching method

For the details about basic parameter items and setting value, refer to "Chapter 4 parameter and operation data".

Chapter 8 Functions

(5) Manual Operation Parameter Teaching

- (a) Change the setting value of designated item from manual operation parameter of module into teaching data.
 (b) Auxiliary data setting of manual operation parameter teaching command

Items	Setting value		Description	
Teaching data	Refer to "setting range"		Set the teaching value of parameter selected	
			Setting range	
Teaching items	1	Jog high speed	Bias speed ~ Speed limit	Select the parameter item to execute teaching
	2	Jog low speed	Bias speed ~ Jog high speed	
	3	Jog acc. time	0 ~ 2147483647	
	4	Jog dec. time		
	5	Inching speed	Bias speed ~ Speed limit	
Teaching method	0 : RAM teaching 1 : ROM teaching		Set the teaching method	

For the details about basic parameter items and setting value, refer to "Chapter 4 parameter and operation data".

(6) I/O Signal Parameter Teaching

- (a) Change the setting value of designated item from I/O signal parameter of module into teaching data.
 (b) Auxiliary data setting of I/O signal parameter teaching command

Items	Setting value		Description
Teaching data	Bit 0	High limit signal	Set the setting form of input signal parameter. If bit is 0, the corresponding signal is recognized as A contact, If it is 1, the signal is recognized as B contact.
	Bit 1	Low limit signal	
	Bit 2	DOG signal	
	Bit 3	HOME signal	
	Bit 4	Emergent stop/Dec. stop signal	
	Bit 5	Drive ready signal	
	Bit 6	Servo On output signal	
	Bit 7	Servo reset output signal	
	Bit 8 ~ Bit 15	-	
Teaching method	0 : RAM teaching 1 : ROM teaching		Set the teaching method

For the details about basic parameter items and setting value, refer to "Chapter 4 parameter and operation data".

(7) Common Parameter Teaching

- (a) Change the setting value of designated item from common parameter of XPM module into teaching data.
 (b) Auxiliary data setting of common parameter teaching command

Items	Setting value		Description	
Teaching data	Refer to "setting range"		Set the teaching value of parameter selected	
			Setting range	
Teaching items	1	Speed override	0 : % setting 1 : speed setting	Select the parameter item to execute teaching
	2	Encoder pulse input	0 : CW/CCW 1 multiplying 1 : PULSE/DIR 1 multiplying 2 : PHASE A/B 4 multiplying	
	3	Maximum value of encoder	-2147483648 ~ 2147483647	
	4	Minimum value of encoder		
	5	Pulse output level	0 : Low Active 1 : High Active	
	6	Continuous operation	0: Disable 1: Enable	
Teaching method	0 : RAM teaching 1 : ROM teaching		Set the teaching method	

For the details about basic parameter items and setting value, refer to "Chapter 4 parameter and operation data".

8.7.3 Operation Data Change from Program

User may modify the positioning operation data set on XG-PM with operation data teaching command.

(1) Characteristics of Control

- (a) Change setting value of designated step and item from PLC's operation data into teaching data.
- (b) Operation data teaching command is available to be executed when the axis is operating. But teaching data of operating step do not apply instantly. Operating step data will apply end of present step operation.
- (c) RAM teaching and ROM teaching are available depending on the saving position.

- RAM teaching

When executing teaching to operation data of embedded positioning and operating embedded positioning in power connection, user may change speed value or position value but the speed value and position value are not saved in non-power connection.

- ROM teaching

When executing teaching to operation data of embedded positioning and operating embedded positioning in power connection, user may change speed value or position value and operation data is saved permanently even in non-power connection. .(The number of Rom teaching time is limited. /about 1,000,000 times)

(d) Auxiliary data setting of operation data teaching command

Items	Setting value	Description		
Teaching data	Refer to "Setting range"	Set the teaching value of parameter selected		
		Setting range		
Teaching items	1	Goal position	-2147483648 ~ 2147483647	Select the parameter item to execute teaching
	2	Auxiliary point of Circular interpolation	-2147483648 ~ 2147483647	
	3	Operating speed	1 ~ Speed limit	
	4	Dwell time	0 ~ 65535	
	5	M code	0 ~ 65535	
	6	Set a sub axis	Set it on Bit 0 ~ Bit 3 0 : Not be set 1 : Be set	
	7	Helical interpolation	0 : Not use 1 ~ 4 : axis1 ~ axis4	
	8	No. of circular interpolation turn	0 ~ 65535	
	9	Coordinates	0 : Absolute 1 : Relative	
	10	Control method	0 : single axis position control 1 : single axis speed control 2 : single axis Feed control 3 : Linear interpolation control 4 : Circular interpolation control	
	11	Operating method	0 : Singular 1 : Repeat	
	12	Operating pattern	0 : End 1 : Keep 2 : Continuous	
	13	Size of circular arc	0 : Circular arc < 180 1 : Circular arc >= 180	
	14	Acc. no.	0 ~ 3	
	15	Dec. no.	0 ~ 3	
	16	Method of circular interpolation	0 : Middle point 1 : Center point 2 : Radius	
	17	Direction of circular interpolation	0 : CW 1 : CCW	
Step no.	0 ~ 400	Set the step no. of operation data to execute teaching		
Teaching method	0 : RAM Teaching 1 : ROM Teaching	Set the teaching method		

For the details about basic parameter items and setting value, refer to "Chapter 4 parameter and operation data".

Chapter 8 Functions

8.7.4 Write/Read Variable Data

Parameter, operation data, CAM data can be read by “Read Variable Data” command and written by “Write Variable Data” command directly.

(1) Read Variable Data

- You read data you want by designating module internal memory address of parameter, operation data, CAM data directly.
- Reads data as many as “Block size” starting position set in “Read address” with WORD unit to CPU among parameter, operation data, CAM data. In case “CNT” is higher than 2, reads blocks with interval of “Block offset” starting “Read address” as many as “CNT”-1.
- Max. data size (block size x No. of block) you can read with one command is 128 WORD
- “Read Variable Data” command can be executed in operation.
- Auxiliary data setting of “Read Variable Data” command

Item	Setting value	Description
Read address	0 ~ 49586	Sets head address of Read Data
Block offset	0 ~ 49586	Sets offset between blocks of Read Data
Block size	1 ~ 128	Sets size of block
No. of block	1 ~ 128	Sets No. of Read Block

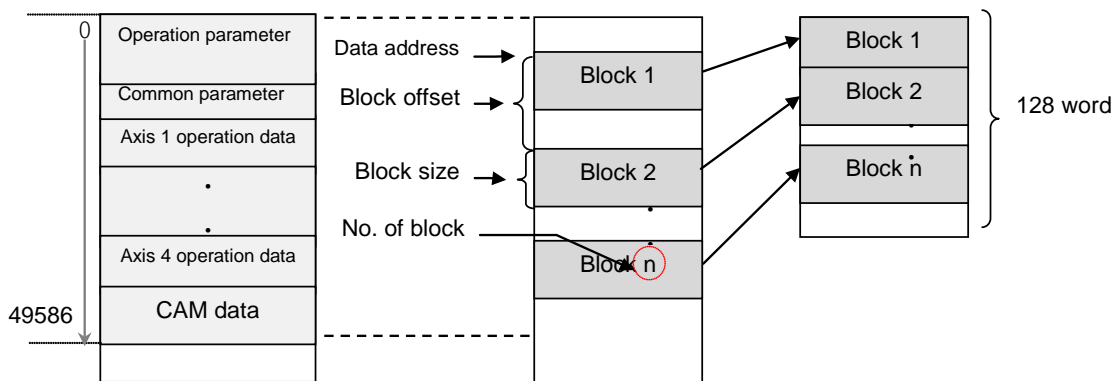

(f) Restriction

In the following case, error occurs and can't execute “Read Variable Data” command

- Data setting error (Error code: 711)
 - Read data size (Block size x No. of block) is 0 or higher than 128 WORD.
 - Read data address [Read address + {block offset x (No. of block -1)} + Block size] is higher than last address value (49586)

Note

If you execute “Read Variable Data” command in XGB PLC, Read data from positioning module is saved in common area. To save in device for using in PLC program, use GETM command [Read address: 0, data size: Read data size (DWORD)]

In XGB PLC, Read data is saved in register set in Function Block automatically.

(2) Write Variable Data

- (a) You write data you want by designating module internal memory address of parameter, operation data, CAM data directly.
- (b) Writes data set in PLC program as many as "Block size" starting position set in "Write address" with WORD unit among parameter, operation data, CAM data of positioning module. In case "No. of block" is higher than 2, writes blocks with interval of "OFFSET" starting "Write address" as many as "CNT"-1.
- (c) Max. data size (Block size x No. of block) you can write with one command is 128 WORD.
- (d) "Read Variable Data" command can't be executed in operation. But "Read Variable Data" command can be executed to User CAM data in User CAM operation.
- (e) After executing "Write Variable Data" command, since the changed value is maintained while power is on, in order to keep the changed value, execute "Save parameter/Operation data" command
- (f) Auxiliary data setting of "Write Variable Data" command

Item	Setting value	Description
Data device	0 ~ 49586	Sets device where data to write to module is saved
Write address	0 ~ 49586	Sets head address of positioning module internal memory
Block offset	0 ~ 49586	Sets offset between blocks of Write data
Block size	1 ~ 128	Sets size of block
No. of block	1 ~ 128	Sets No. of Write block

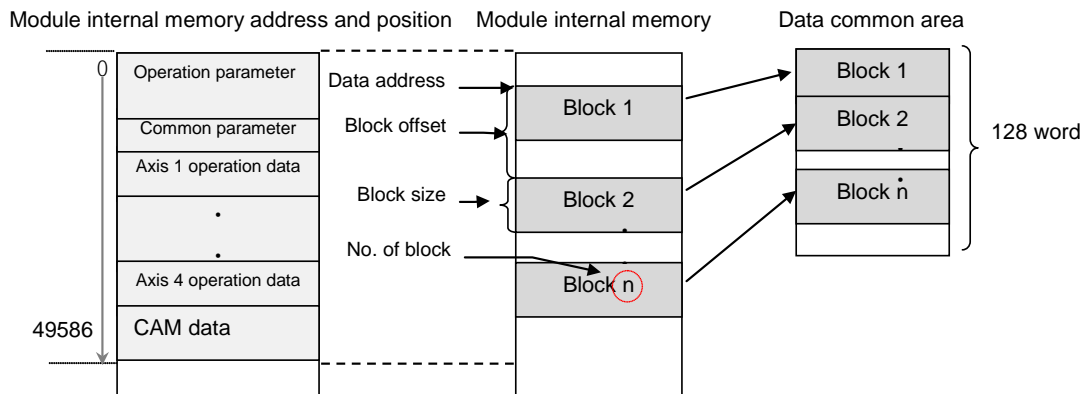

(g) Restriction

In the following case, error occurs and can't execute "Read Variable Data" command

- Data range setting error (Error code: 711)
 - Write data size (Block size x No. of block) is 0 or higher than 128 WORD
 - Write data address [Write address + {Block offset x (No. of block -1)} + Block size] is higher than last address value (49586)
- Block overlap error (Error code: 713)
 - In case module internal block to write is overlapped each other
(In case no. of block is higher than 2, block offset is smaller than block size)
- Execution inhibition error in operation (Error code: 712)
 - Any axis of positioning module is in operation

Chapter 9 Positioning Error Information & Solutions

Chapter 9 Positioning Error Information & Solutions

Here describes the positioning error types and its solutions.

9.1 Positioning Error Information & Solutions

(1) Error Information of Basic Parameter

Error Code	Error Description	Solutions
101	Max. speed value of Basic Parameter exceeds the range.	The speed limit of basic parameter for pulse units are bigger than bias speed and less than 2000000
102	Bias speed value of Basic Parameter exceeds the range.	Bias speed of Basic Parameter should be less than max. speed of Basic Parameter.
103	Pulse output mode value of Basic Parameter exceeds the range.	Pulse output mode of Basic Parameter is 0:CW/CCW 1: Pulse/Dir 2:Phase A/B. Select one among three.
104	Speed limit of basic parameter by degree is bigger than 180 out of range, so circular interpolation can not be executed.	Operate with lower speed limit of Circular Interpolation.

(2) Error Information of Expanded Parameter

Error Code	Error Description	Solutions
111	Extended Parameter software upper/lower limit range error	SW upper limit of Extended Parameter should be greater than or equal to SW lower limit of Extended Parameter.
112	M Code Mode value of Extended Parameter exceeds the range.	M Code output of Extended Parameter is 0:None, 1:With, 2:After. Select one among three.
113	S-Curve rate of Extended Parameter exceeds the range.	Change S-Curve rate of Extended Parameter to be more than 1 and less than 100

(3) Error Information of Manual Operation Parameter

Error Code	Error Description	Solutions
121	Jog high speed value of Manual operation parameter exceeds the range.	Set Jog high speed of Manual operation parameter to be greater than or equal to bias speed of Basic Parameter and less than or equal to max. speed of Basic Parameter.
122	Jog low speed value of Manual operation parameter exceeds the range.	Set Jog low speed of Manual operation parameter to be more than 1 and less than Jog high speed of Manual operation parameter.
123	Inching speed value of Manual operation parameter exceeds the range.	Set Inching speed of Manual operation parameter to be greater than or equal to bias speed of Basic Parameter and less than or equal to max. speed of Basic parameter.

Chapter 9 Positioning Error Information & Solutions

(4) Error Information of Homing Origin Parameter

Error Code	Error Description	Solutions
131	Homing mode value of Homing parameter exceeds the range.	Homing method of Homing parameter is 0:Dog/Origin(Off), 1:Dog/Origin(On),2:High/low limit/Origin, 3: Near Point, 4:High speed origin, 5: High/low, 6:Origin Select one among seven.
132	Homing address of Homing parameter exceeds the range.	Set Homing address of Homing parameter to be greater than SW low limit of Extended parameter and less than SW high limit of Extended Parameter.
133	Homing high speed value of Homing parameter exceeds the range.	Set Homing high speed of Homing parameter to be greater than or equal to bias speed of Basic parameter and less than or equal to max. speed of Basic parameter.
134	Homing low speed value of Homing parameter exceeds the range.	Set Homing low speed of Homing parameter to be greater than or equal to bias speed of Basic parameter and less than or equal to Homing high speed of Homing parameter.

(5) Error Information of Common Parameter

Error Code	Error Description	Solutions
141	Encoder type value of Common parameter exceeds the range.	Set Encoder input signal of Common parameter to be between 0 and 2.
148	Encoder max/min value of common parameter Exceeds the range.	Set Encoder max value smaller than min value, also set encoder max/min value contains current position.

(6) Error Information of Operating Data

Error Code	Error Description	Solutions
151	Not available to set operation speed value of Operation data as "0".	Set operation speed to be greater than "0".
152	Operation speed of Operation data exceeds max. speed value.	Set operation speed to be less than or equal to max. speed set in the Basic Parameter.
153	Operation speed of Operation data is set less than bias speed.	Set operation speed to be greater than or equal to bias speed set in Basic Parameter.
155	Exceeds End/Go on/Continuous operation setting range of Operation data.	Set one from operation pattern (0:End, 1:Go on, 2: Continuous) of operation data to operate
156	Even the operation pattern settled continuous, next command cannot support continuous operation.	Set for abstract positioning control or speed control. If it is for current step command then next step command should be a interpolation command.
157	Even the operation pattern settled continuous, next command cannot support axis of current command.	If operation pattern is continuous, then set both Operation data and next step operation data equally

Chapter 9 Positioning Error Information & Solutions

Error Code	Error Description	Solutions
158	Even the operation pattern set continuous, current command cannot support continuous current command.	Continuous operation only can be operated when it is shortening position control, linear interpolation, and circular interpolation. In other commands, set operation option to end or continuous.
159	Goal position of operation data exceeds the range.	For positioning control operating change goal position more than 2,147,483,648 and less than 2,147,483,647.
160	You can not run continuous operation when the continuous operation bit is disabled.	Check if continuous operation parameter is enabled.

(7) Error Information of Data Writing

Error Code	Error Description	Solutions
171	Parameter writing command cannot be done because of start command execution while XG-PM is sending common parameter	Once current operation is done, eliminate error with error-reset command, then execute writing command again. Do not execute start operation while parameter sending.
172	Parameter writing command cannot be done because of start command execution while XG-PM is sending operating parameter.	Once current operation is done, eliminate error with error-reset command, then execute writing command again. Do not execute start operation while parameter sending.
173	Parameter writing command cannot be done because of start command execution while XG-PM is sending operating data.	Once current operation is done, eliminate error with error-reset command, then execute writing command again. Do not execute start operation while operating data sending.
174	Parameter writing command cannot be done because of start command execution while XG-PM is sending CAM data.	Once current operation is done, eliminate error with error-reset command, then execute writing command again. Do not execute start operation while CAM data sending.
175	Start command cannot be executed while writing sending-parameters or operating-data from XG-PM.	Execute again once writing of parameter or operating data are done.

(8) Error Information of Positioning command and Step control

Error Code	Error Description	Solutions
201	Not possible to carry out Homing command in the state of in operation.	Check if command axis is in operation when the Homing command is executed.
203	Not possible to carry out Homing command in the state of Servo Ready OFF.	Check if Driver Ready signal of command axis is OFF when Homing command is executed.
211	Not possible to carry out Floating origin setting command in the state of in operation.	Check if command axis is in operation when Floating origin setting command is executed.
212	Not possible to carry out Floating origin setting command in the state of Servo Ready OFF.	Check if Driver Ready signal of command axis is OFF when Floating origin setting command is executed.
221	Not possible to carry out Direct Start command in the state of in operation.	Check if command axis is in operation when Direct Start command is executed.

Chapter 9 Positioning Error Information & Solutions

Error Code	Error Description	Solutions
223	Not possible to carry out Direct Start command in the state of M Code ON.	Check if M code signal of command axis is ON when Direct Start command is executed. XMOF command can make M Code OFF.
224	Not possible to carry out Direct Start command at the absolute coordinate in the origin unsettled state.	Not possible to carry out absolute coordinate operation in the origin unsettled state. Check the coordinate of operation data to operate and the current origin determination. Available to carry out absolute coordinate operation after origin determination by Homing command or floating origin setting command.
225	Not possible to carry out Direct Start command in the state of Servo Ready OFF.	Check if Driver Ready signal of command axis is OFF when Direct Start command is executed.
230	Not possible to carry out continuous operating out Indirect Start command in the state of feed control.	Execute indirect start with setting of feed control for operation control, continuous for operating pattern if it is set as continuous or end.
231	Not possible to carry out Indirect Start command in the state of in operation.	Check if command axis is in operation when Indirect Start command is executed.
233	Not possible to carry out Indirect Start command in the state of M Code ON.	Check if M code signal of command axis is ON when Indirect Start command is executed Available to make M Code OFF by XMOF command.
234	Not possible to carry out Indirect Start command at the absolute coordinate in the origin unsettled state.	Not available to carry out absolute coordinate operation in the origin unsettled state. Check the coordinate of step to operate and the current origin determination state. Available to carry out absolute coordinate operation after origin determination by Homing command or floating origin setting command.
235	Not possible to carry out Indirect Start command in the state of Servo Ready OFF.	Check if Driver Ready signal of command axis is OFF when Indirect Start command is executed.
236	Not possible to carry out Continuous operation of Indirect Start at speed control.	Check if there is no step that control method is set as speed control in the middle of Continuous operation of position control among Operation data and operation pattern is set as Continuous.
237	Step no. of POINT start is limited up to 20.	Set the step no. for POINT start to be less than 20 and greater than 1
238	Not possible to carry out Continuous operation of Indirect Start at S-Curve acceleration /deceleration pattern.	Check if acc./dec. pattern of extended parameter of command axis is set as S-Curve.
241	Not possible to carry out Linear interpolation Start in the state that main axis of linear interpolation is in operation.	Check if main axis is in operation when Linear interpolation command is executed.
242	Not possible to carry out Linear interpolation Start in the state that subordinate axis 1 of linear interpolation is in operation.	Check if subordinate axis 1 is in operation when Linear interpolation command is executed.
247	Not possible to carry out Linear interpolation Start in the state that M Code signal of main axis of Linear interpolation is ON.	Check if M Code signal of main axis is ON when Linear interpolation command is executed. Available to make M Code OFF by XMOF command.
248	Not possible to carry out Linear interpolation Start in the state that M Code signal of subordinate axis 1 of Linear interpolation is ON.	Check if M Code signal of subordinate axis 1 is ON when Linear interpolation command is executed. Available to make M Code OFF by XMOF command.

Chapter 9 Positioning Error Information & Solutions

Error Code	Error Description	Solutions
250	Not possible to carry out positioning operation of absolute coordinate in the state that main axis of Linear interpolation is origin unsettled.	Not available to carry out absolute coordinate operation in the origin unsettled state. Check the coordinate of step to operate and the current origin determination state. Available to carry out absolute coordinate operation after origin determination by Homing command or floating origin setting command.
251	Not possible to carry out positioning operation of absolute coordinate in the state that subordinate axis 1 of Linear interpolation is origin unsettled.	Not available to carry out absolute coordinate operation in the origin unsettled state. Check the coordinate of step to operate and the current origin determination state. Available to carry out absolute coordinate operation after origin determination by Homing command or floating origin setting command.
253	In case that main axis and subordinate axis is set wrong in Linear interpolation. (the case that the subordinate axis is not assigned, the case that only one axis is assigned, or the case that no axis is assigned)	Check if the subordinate axis is not assigned, or only one axis is assigned, or no axis is assigned when Linear interpolation command is executed.
254	Not possible to carry out the operation as Servo Ready is OFF at the main axis of Linear interpolation	Check if Driver Ready signal of master axis is OFF when Linear interpolation command is executed.
255	Not possible to carry out the operation as Servo Ready is OFF at the subordinate axis of Linear interpolation	Check if Driver Ready signal of subordinate axis is OFF when Linear interpolation command is executed.
261	Main axis speed of linear interpolation exceeds its speed limit.	Set low for main axis speed so that linear interpolation speed limit would not exceeds.
262	Not possible to insert the circular because the position of 2axis continuous linear interpolation circular insertion are longer than goal position.	Set low for position of 2 axis linear interpolation continuous operating circular insertion from expanded parameter, smaller than goal position.
263	Not possible to insert the circular because two lines of 2axis continuous linear interpolation circular insertion are at the same position.	Set again for goal position or set "0:Not insert circular" for 2 axis linear interpolation continuous operating circular insertion.
264	Not possible to insert the circular because the radius of 2axis continuous linear interpolation circular insertion are bigger than 2147483647.	Set again for goal position so those two lines would not be at the same location or set "0:Not insert circular" for 2 axis linear interpolation continuous operating circular insertion then execute linear interpolation.
265	Not possible to insert the circular because the radius of 2axis continuous linear interpolation circular insertion are rarely small or its speed limits are too high.	Make bigger for circular insert position and less for speed limit or set "0:Not insert circular" for 2 axis linear interpolation continuous operating circular insertion then execute linear interpolation.
266	Not possible to insert the circular because the circular of 2axis continuous linear interpolation circular insertion are at the same position from where it is supposedly located.	Set again for goal position so those two lines would not be at the same location or set "0:Not insert circular" for 2 axis linear interpolation continuous operating circular insertion then execute linear interpolation.
270	Error of radius setting from radius circular interpolation.	Set radius setting from circular interpolation main axis operating data for 80% bigger than its half distance of beginning point to end point.
271	Not possible to carry circular interpolation start in the state that main axis of circular interpolation is in operation.	Check if main axis is in operation when circular interpolation command is executed.
272	Not possible to carry circular interpolation start in the state that subordinate axis of circular interpolation is in operation	Check if subordinate axis is in operation when circular interpolation command is executed.

Chapter 9 Positioning Error Information & Solutions

Error Code	Error Description	Solutions
275	Not possible to carry circular interpolation start in the state that M Code signal of main axis of circular interpolation is ON.	Check if M Code signal of main axis is ON when circular interpolation command is executed. Available to make M Code OFF by XMOF command.
276	Not possible to carry circular interpolation start in the state that M Code signal of subordinate axis of circular interpolation is ON.	Check if M Code signal of subordinate axis is ON when circular interpolation command is executed. Available to make M Code OFF by XMOF command.
277	Not possible to carry positioning operation of absolute coordinate in the state that main axis of circular interpolation is origin unsettled.	Not available to carry out absolute coordinate operation in the origin unsettled state. Check the coordinate of step to operate and the current origin determination state. Available to carry out absolute coordinate operation after origin determination by Homing command or floating origin setting command.
278	Not possible to carry positioning operation of absolute coordinate in the state that subordinate axis of circular interpolation is origin unsettled	Not available to carry out absolute coordinate operation in the origin unsettled state. Check the coordinate of step to operate and the current origin determination state. Available to carry out absolute coordinate operation after origin determination by Homing command or floating origin setting command.
279	Incorrect setting of main axis from circular Interpolation. (Either, unset main axis, incorrect helical interpolation axis, exceeding number of current possible operating axis)	Execute circular interpolation after 1. Set one more operational axis from circular interpolation data except main axis 2. Set one more operate able axis from helical interpolation.
280	Not possible to carry out the operation as Drive Ready is OFF in main axis of circular interpolation.	Check if Driver Ready signal of main axis is OFF when circular interpolation command is executed.
281	Not possible to carry out the operation as Drive Ready is OFF in subordinate axis of circular interpolation.	Check if Driver Ready signal of subordinate axis 1 is OFF when circular interpolation command is executed.
282	Not possible to carry out degree operation in circular interpolation.	Check if the unit of Basic Parameter of main axis of circular interpolation command is set as degree.
283	Not possible to carry out degree operation in circular interpolation.	Check if the unit of Basic Parameter of subordinate axis of circular interpolation command is set as degree.
284	Not possible to carry out the operation if start point =center point (middle point) or center point (middle point) =end point in circular interpolation.	Check if the center point or middle point is set as the same point as start point or end point in circular interpolation.
285	The start point and end point is Not possible to be same in the middle point mode of circular interpolation.	Check if circular interpolation method of Common parameter is set as middle point and if the position of start point is not the same as end point..
286	Radius setting error in circular interpolation.	The radius of the circle to carry out circular interpolation operation is up to 2,147,483,647pulse. Check if it is set in order to carry out the circular interpolation more than the size
287	Not possible to carry out the operation as linear profile comes out of circular interpolation.	Check if circular interpolation method of Common parameter is set as Middle point and the middle point is set to be aligned with start point and end point.
290	Since angular velocity is greater than 90°, correct circle cannot be drawn.	Set operation speed lower than 90° for circular Interpolation angular velocity.
291	Not possible to carry out Synchronous Start command in the state of in operation.	Check if the Error occurred axis is included in Synchronous Start command and if there is no axis in operation when the command is executed.

Chapter 9 Positioning Error Information & Solutions

Error Code	Error Description	Solutions
293	Not possible to carry out Synchronous Start command in the state of M Code ON.	Check if the Error occurred axis is included in Synchronous Start command and if M Code signal is ON when the command is executed. Available to make M Code OFF by XMOF command
294	Not possible to carry out Synchronous Start command in case that there is no goal position.	Check if the Error occurred axis is included in Synchronous Start command, and if the goal position of operation data of the step to operate is not the same as the current position for absolute coordinate and is set as "0" for relative coordinate.
295	Not possible to carry out Synchronous Start command in the state that Servo Ready is OFF.	Check if the Error occurred axis is included in Synchronous Start command, and if Driver Ready signal is OFF when the command is executed.
296	In case that Synchronous Start command axis setting is wrong.	Check if only one axis of Simultaneous Start command is assigned. The axis assignment address means 0 bit : 1 axis, 1 bit :2Y axis, 2 bit : 3 axis, 3 bit : 4axis and each bit is set as "1" for axis assignment
297	An error occurred from axis of synchronous start operating.	Execute synchronous start after eliminate an error element from error occurred axis.
301	Not possible to carry out Speed/Position control switching command not in the state of in operation.	Check if the axis is 'stop' state when speed/position control switching command is executed.
302	Not possible to carry out Speed/Position control switching command not in the state of speed control.	Check if the axis is 'speed control' state when speed/position control switching command is executed.
303	Not possible to carry out Speed/Position control switching command at subordinate axis of Synchronous Start operation.	Check if the axis is in operation by subordinate axis of Synchronous Start operation when speed/position control switching command is executed.
304	Not possible to carry out Speed/Position control switching command if there is no goal position.	Check if the operation has the goal position when speed /position control switching command is executed.
306	For "position specified speed/position switching instruction", when "Unlimited length repetition= enable" and "Speed/position switching coordinate=absolute", the position value which makes the object go in the opposite direction is not valid.	For "position specified speed/position switching instruction", input the positive position value for the forward direction and the negative position value for the reverse direction.
311	Not possible to carry out Position/Speed control switching command not in the state of in operation.	Check if the axis is 'stop' state when position/speed control switching command is executed.
312	Not possible to carry out Position/Speed control switching command at subordinate axis of Synchronous Start operation.	Check if the axis is in operation by subordinate axis of Synchronous Start operation when position/speed control switching command is executed.
313	Not possible to carry out Position/Speed control switching command in the state of circular interpolation operation.	Check if the axis is in circular interpolation operation when position/speed control switching command is executed.
314	Not possible to carry out Position/Speed control switching command in the state of Linear interpolation operation.	Check if the axis is in linear interpolation operation when position/speed control switching command is executed.
316	Not possible to carry out Position/Speed switching command in the state of decreasing section.	Execute Position/Speed switching command before the decreasing of axis, while in increasing section or regular section.
317	Not possible to carry out Position/Speed switching command when it is not either at the positioning control or inching operation	Execute Position/Speed switching command while the commanding axis is positioning control or inching operation
322	Not possible to carry out deceleration stop command in the state of Jog operation.	Not possible to carry out deceleration stop command in the state of Jog operation.

Chapter 9 Positioning Error Information & Solutions

Error Code	Error Description	Solutions
324	Deceleration time setting from deceleration stop commands are out of range.	The range of deceleration time is between 0 and 2147483647. Execute deceleration command after set the value from its range.
331	Not possible to carry out Skip command not in the state of in operation.	Check if the axis is 'stop' state when Skip command is executed.
332	Not possible to carry out Skip command for subordinate axis of Linear interpolation operation.	Check if the axis is in operation by subordinate axis of Linear interpolation when Skip command is executed.
333	Not possible to carry out Skip command for subordinate axis of Synchronous Start operation.	Check if the axis is in operation by subordinate axis of Synchronous Start operation when Skip command is executed.
335	Not possible to carry out Skip command in the state of Jog operation.	Check if the axis is in Jog operation when Skip command is executed.
336	Not possible to carry out Skip command in the state of Direct Start operation.	Check if the axis is in Direct Start operation when Skip command is executed.
337	Not possible to carry out Skip command in the state of Inching operation.	Check if the axis is in Inching operation when Skip command is executed.
338	Not possible to carry out Skip command for subordinate axis of circular interpolation operation.	Check if the axis is in operation by subordinate axis of circular interpolation operation when Skip command is executed.

Chapter 9 Positioning Error Information & Solutions

Error Code	Error Description	Solutions
341	Not possible to carry out Synchronous Start by Position command in the state of in operation.	Check if the axis is in operation when Synchronous Start by Position command is executed.
343	Not possible to carry out Synchronous Start by Position command in the state of M Code ON.	Check if the M Code signal of the axis is ON when Synchronous Start by Position command is executed. Available to make M Code OFF by XMOF command.
344	Not possible to carry out Synchronous Start by Position command at the absolute coordinate in the state of origin unsettled.	Not available to carry out absolute coordinate operation in the origin unsettled state. Check the coordinate of step to operate and the current origin determination state. Available to carry out absolute coordinate operation after origin determination by Homing command or floating origin setting command.
345	Not possible to carry out Synchronous Start by Position command in the state that Servo Ready is OFF.	Check if Driver Ready signal of the axis is OFF when Synchronous Start by Position command is executed.
346	Not possible to carry out Synchronous Start by Position command in the state that the origin of main axis is not settled.	Check if main axis is in the origin unsettled state when Synchronous Start command is executed.
347	There is error in setting main axis/subordinate axis of Synchronous Start by Position command.	Check if main axis of Synchronous Start by Position command is set as the same as command axis. Main axis is set by writing 1~4(Axis1 ~ Axis4)0(X axis) and 9(Encoder) to the setting address.
350	Not possible to carry out Synchronous Start by Speed command in the state of in operation of main axis.	Execute Synchronous Start by Speed command while main axis is not operating when it is state of stop.
351	Not possible to carry out Synchronous Start by Speed command in the state of in operation.	Check if the axis is in operation when Synchronous Start by Speed command is executed.
353	Not possible to carry out Synchronous Start by Speed command in the state of M Code ON.	Check if the M Code signal of the axis is ON when Synchronous Start by Speed command is executed. Available to make M Code OFF by XMOF command.
354	Not possible to carry out Synchronous Start by Speed command in the state that Servo Ready is OFF.	Check if Driver Ready signal of the axis is OFF when Synchronous Start by speed command is executed.
355	There is error in setting main axis/subordinate axis of Synchronous Start by Speed command.	Check if main axis of Synchronous Start by Speed command is set as the same as command axis. Main axis is set by writing 1~4(Axis1 ~ Axis4)0(X axis) and 9(Encoder) to the setting address.
357	The speed of Synchronous Start by Speed command cannot exceeds its speed limit.	Set low for main axis ratio/second axis ratio values so The value would not exceed its limitation.
361	Not possible to carry out Position Override command not in the state of in operation (Busy).	Check if the axis is 'stop' state when Position Override command is executed.
362	Not possible to carry out Position Override command not in the state of in dwell.	Check if the axis is in dwell when Position Override command is executed..
363	Not possible to carry out Position Override command not in the state of positioning operation.	Check if the axis is in operation by position control when Position Override command is executed.
364	Not possible to carry out Position Override command for the axis of Linear interpolation operation.	Check if the axis is in Linear interpolation operation when Position Override command is executed.

Chapter 9 Positioning Error Information & Solutions

Error Code	Error Description	Solutions
365	Not possible to carry out Position Override command for the axis of circular interpolation operation.	Check if the axis is in circular interpolation operation when Position Override command is executed.
366	Not possible to carry out Position Override command for the subordinate axis of Synchronous operation.	Check if the axis is in operation by subordinate axis of Synchronous Start operation when Position Override command is executed.
371	Not possible to carry out Speed Override command not in the state of in operation (Busy).	Check if the axis is 'stop' state when Speed Override is executed.
372	Exceeds the range of speed override value.	Speed value of Speed Override command should be less than or equal to max. speed set in Basic Parameter. Check the speed value.
373	Not possible to carry out Speed Override command for the subordinate axis of Linear interpolation operation.	Check if the axis is in operation by subordinate axis of Linear interpolation operation when Speed Override command is executed.
374	Not possible to carry out Speed Override command for the axis of circular interpolation operation.	Check if the axis is in operation by subordinate axis of circular interpolation operation when Speed Override command is executed.
375	Not possible to carry out Speed Override command for the subordinate axis of Synchronous operation.	Check if the axis is in operation by subordinate axis of Synchronous Start operation when Speed Override command is executed.
377	Not possible to carry out Speed Override command in the deceleration section.	Check if the axis is in the state of deceleration stop when Speed Override command is executed.
378	Not possible to carry out Speed Override command in S-curve acceleration/deceleration pattern.	Check if the acceleration/deceleration pattern of Extended Parameter of command axis is set as S-Curve.
381	Not possible to carry out Random position speed override command not in the state of in operation.	Check if the axis is 'stop' state when Random position speed override command is executed.
382	Not possible to carry out Random position speed override command not in positioning operation.	Check if the axis is in speed control operation when Random position speed override command is executed.
383	Exceeds the speed override value range of Random position speed override command.	Speed value of Random position speed override command should be less than or equal to max. speed set in Basic Parameter. Check the speed value.
384	Not possible to carry out Random position speed override command for the subordinate axis of Linear interpolation operation.	Check if the axis is in operation by subordinate axis of Linear interpolation operation when Random position speed override command is executed.
385	Not possible to carry out Random position speed override command for the axis of circular interpolation operation.	Check if the axis is in circular interpolation operation when Speed Override command is executed.
386	Not possible to carry out Random position speed override command for the subordinate axis of Synchronous operation.	Check if the axis is in operation by subordinate axis of Synchronous Start operation when Speed Override command is executed.
389	Not possible to carry out Random position speed override command in S-Curve acceleration / deceleration pattern.	Check if the acceleration/deceleration pattern of Extended Parameter of command axis is set as S-Curve
390	Not possible to carry out Continuous operation command in S-Curve acceleration/deceleration pattern.	Check if the acceleration/deceleration pattern of Extended Parameter of command axis is set as S-Curve
391	Not possible to carry out Continuous operation command not in the state of in operation.	Check if the axis is 'stop' state when Continuous operation command is executed.
392	Not possible to carry out Continuous operation command not in the state of in dwell.	Check if the axis is in dwell when Continuous operation command is executed.

Chapter 9 Positioning Error Information & Solutions

Error Code	Error Description	Solutions
393	Not possible to carry out Continuous operation command not in the settled of positioning operation.	Check if the axis is in speed control operation when Continuous operation command is executed.
394	Speed data value of Continuous operation command exceeds the allowable range.	Speed value of Continuous operation command should be less than or equal to max. speed set in Basic Parameter. Check the speed value.
395	Not possible to carry out Continuous operation command for the subordinate axis of Linear interpolation operation.	Check if the axis is in operation by subordinate axis of Linear interpolation operation when Continuous operation command is executed.
396	Not possible to carry out Continuous operation command for the axis of circular interpolation operation axis.	Check if the axis is in circular interpolation operation when Continuous operation command is executed.
397	Not possible to carry out Continuous operation command for the subordinate axis of Synchronous operation.	Check if the axis is in operation by subordinate axis of Synchronous Start operation when Continuous operation command is executed.
399	Not possible to carry out Continuous operation command at the last step of Operation data.	Check if the axis is in operation of 400 th step when Continuous operation command is executed.
400	Not possible to carry out Continuous operation command in the state of Direct Start operation.	Check if the axis is in operation by Direct Start command that Continuous operation command is executed.
401	Not possible to carry out Inching command in the state of in operation.	Check if the axis is in operation when Inching command is executed.
403	Not possible to carry out Inching command in the state that Drive Ready is OFF.	Check if Drive Ready signal of the axis is OFF when Inching command is executed.
411	Not possible to carry out Jog Start command in the state of in operation.	Check if the axis is in operation when Jog Start command is executed.
413	Not possible to carry out Jog Start command in the state that Servo Ready is OFF.	Check if Driver Ready signal of the axis is OFF when Jog Start command is executed.
431	Not possible to carry out Return to the Position before Manual Operation in the state of in operation.	Check if the axis is in operation when Return to the position before manual operation command is executed .
434	Not possible to carry out Return to the Position before Manual Operation in the state that Drive Ready is OFF.	Check if Driver Ready signal of the axis is ON when Return to the position before manual operation command is executed.
441	Not possible to carry out Start step no. Change/Repeat Operation Start step no. assignment command in the state of in operation.	Check if the axis is in operation when Start step no. change /repeat command is executed.
442	Exceeds the step assignment range of Start step no. Change/Repeat Operation Start step no. assignment command.	Check if the setting step value of Start step no. change command or repeat operation start step no. assignment command is greater than or equal to 1 and less than or equal to 400.
451	Not possible to carry out Current Position Preset command in the state of in operation.	Check if the axis is in operation when Current position preset command is executed.
452	Not possible to set the auxiliary position data value out of range of software high/low limit while Current Position Preset command is executed.	Check if the position value of current position preset command is within the range of soft high /low limit set in Extended Parameter.
461	Not possible to carry out Position Teaching command in the state of in operation.	Check if the axis is in operation when Position teaching command is executed.

Chapter 9 Positioning Error Information & Solutions

Error Code	Error Description	Solutions
462	Not possible to carry out Teaching Array command for the data over 16.	Check if the data no. of Teaching Array command is set in the range that is greater than or equal to 1 and less than or equal to 16.
463	Not possible to carry out Speed Teaching command in the state of in operation.	Check if the axis is in operation when Speed teaching command is executed.
465	Error from step number appointing which are about to execute teaching operation.	Make sure step for teaching operation is smaller than 400 or same as 400.
466	Teaching list error for multi teaching command.	Execute teaching command after set teaching data list as 0:position or 1:speed
467	Teaching method error for multi teaching command.	Execute teaching command after set teaching method as 0:position or 1:speed
471	Parameter teaching command cannot be Executed while its operating.	Check if the axis was operating when parameter teaching commands are executing
472	Operating data teaching command cannot be Executed while its operating.	Check if the axis was operating when operating Data teaching commands are executing
473	Set data cannot be teaching.	Execute teaching command after setting right value for parameter teaching data or operating data teaching list.
474	Parameter/Operation data saving commands cannot be done while the axis is operating.	Check if the axis is operating when Parameter/ Operation data saving commands are operating. Execute Parameter/Operation command when any axis are not operating.
475	Error of value for teaching data is out of range.	Execute teaching command after setting value of parameter teaching or operating data teaching data among its set range.
476	Error of value for teaching method is out of range.	Execute teaching command after setting value of parameter teaching or operating data teaching data for 1(RAM teaching) or 2(ROM teaching).
481	Internal emergency stop	Eliminate reason of emergency stop and execute XCLR command to delete the error.
491	Error of external emergency stop	Eliminate reason of emergency stop and execute XCLR command to delete the error.
492	Hard Upper Error	Be out of limited external upper signal rangeby using counter direct jog command. Then execute XCLR command to delete the error.
493	Hard Lower Error	Be out of limited external lower signal range by using direct jog command. Then execute XCLR command to delete the error.
501	Soft Upper Error	Be out of limited soft upper range by using counter direct jog command. Then execute XCLR command to delete the error.
502	Soft Lower Error	Be out of limited soft upper range by using direct jog command. Then execute XCLR command to delete the error.
511	Inappropriate command	Check the commands are appropriate. Look up the references for COMMANDS.

Chapter 9 Positioning Error Information & Solutions

Error Code	Error Description	Solutions
512	Step number of auxiliary data is out of range.	Commands set for bigger than 400. Set it Between 1 and 400.
522	The command cannot be done when the signal of Drive Ready is OFF during the operation.	Execute again once Drive Ready is ON.
531	Error for Encoding number exceed from Encoder preset command.	Execute Encoder preset command after set "0" For encoder number.
532	Preset command cannot be done because of the axis which using encoder as a main axis	Execute Encoder preset when the encoder using axis is not operating
534	The position of Encoder preset exceeds from Max or Min value of encoder.	Execute Encoder preset command after set the value of encoder position preset as bigger than Min value and smaller than Max value.
541	Ellipse interpolation cannot be operated while main axis of circular interpolation is operating.	Execute the Ellipse interpolation command when main axis is not operating.
542	Ellipse interpolation cannot be operated while support axis of circular interpolation is operating.	Execute the circular interpolation command when subordinate axis is not operating
543	Ellipse interpolation start cannot be operated when M code from main axis circular interpolation is "ON."	Execute Ellipse interpolation command after set M code from main axis Ellipse interpolation is "OFF" with XMOF command.
544	Ellipse interpolation start cannot be operated when M code from subordinate axis circular interpolation is "ON."	Execute Ellipse interpolation command after set M code from subordinate axis Ellipse interpolation is "OFF" with XMOF command.
545	Unable to execute the determine absolute coordinate position operation when ellipse interpolation main axis is not positioned.	Execute Ellipse interpolation command after set main axis as a state of being origin with homing command or floating origin setting.
546	Unable to execute the determine absolute coordinate position operation when ellipse interpolation sub axis is not positioned.	Execute Ellipse interpolation command after set sub axis as a state of being origin with homing command or floating origin setting.
547	Incorrect setting for main and subordinate axis from Ellipse interpolation.(Unset for main/subordinate axis Set as Helical interpolation Exceed number of possible current operating Axis.)	Execute Ellipse interpolation after set a axis From subordinate axis setting beside its main axis and unset Helical interpolation.
548	Ellipse interpolation cannot be operated with middle point setting and radius setting.	Ellipse interpolation only can operate in center point setting. Execute Ellipse interpolation after changing operating data Ellipse interpolation mode for center point setting.
549	Cannot be operated when Drive Ready of Ellipse interpolation main axis is "OFF."	Execute Ellipse interpolation command after Drive Ready is "ON" of main axis.
550	Cannot be operated when Drive Ready of Ellipse interpolation subordinate axis is "OFF."	Execute Ellipse interpolation command after Drive Ready is "ON" of subordinate axis.
551	Cannot be operated when unit of Ellipse interpolation main axis is "degree."	Execute Ellipse interpolation command after Basic parameter unit is "degree" of main axis.
552	Cannot be operated when unit of Ellipse interpolation subordinate axis is "degree."	Execute Ellipse interpolation command after basic parameter unit is "degree" of subordinate axis.
553	Cannot be operated when three parameters of Ellipse interpolation are same. (start point=main point=end point)	Execute Ellipse interpolation command after set those parameters differently. (start point, main point, end point)

Chapter 9 Positioning Error Information & Solutions

Error Code	Error Description	Solutions
554	Radius setting error from Ellipse interpolation.	The range of possible execution for Ellipse Interpolation is between 0 and 2147483647. Set radius of circle from its range, smaller than 2147483647pulse.
555	Exact circle cannot be draw because of degree of Ellipse interpolation is bigger than 90°	Set lower for operation speed so that degree of Ellipse interpolation is smaller than 90°
556	Continuous operation cannot be done for Ellipse interpolation.	Execute Ellipse interpolation after terminate operation step of circular interpolation.
557	Ellipse interpolation only can be operated when control setting is circular interpolation.	Execute Ellipse interpolation after change control setting for drive step of Ellipse interpolation to circular interpolation.
558	Operation cannot be executed when beginning point and end point of ellipse interpolation are not same.	Execute Ellipse interpolation after set the goal Position of ellipse interpolation operating step Same as current position.
559	Operation cannot be executed when operating degree of ellipse interpolation is "0."	Set the value of operating degree for ellipse interpolation, larger than "0."(1~65535)
571	Operation cannot be executed because of error from sub-coordinate axis of main axis by current axis.	Check the error from subordinate axis of main axis by current axis whether it is occurred during the operation of current axis.
572	Operation cannot be executed because of error from sub coordinate axis of main axis by interpolated axis.	Check the error from subordinate axis of main axis by current axis whether it is occurred during the operation of interpolated axis.
701	Not possible to carry out CAM command in the state of in operation.	Execute CAM command when main axis is not operating.
702	Not possible to carry out CAM command in the state of M Code ON	Execute CAM command after set M Code OFF from commanding axis with XMOF.
703	Not possible to carry out CAM command in the state that Drive Ready is OFF.	Execute CAM command when Drive Ready is "ON."
704	Error of setting main/subordinate axis from CAM command.	Set main axis for CAM command as other axis besides its command axis from connecting axis. Set parameters are 1axis through 4axis.
705	CAM command of main axis cannot be executed during the operation.	Execute CAM command when the main axis setting of CAM command is not operating.
706	Error of CAM block setting from CAM command.	Execute CAM command after set a CAM block from CAM command as bigger than 1 and smaller than 8.
707	Error for CAM data of appointed block from CAM command.	Execute CAM command after set right data for appointed block from CAM command.
708	The speed of subordinate axis from CAM command cannot exceed its speed limit.	Set lower speed for main axis so that speed of subordinate axis from CAM data which is calculated by subordinate position would not exceed its speed limit.
709	For CAM command, in case main axis is encoder, main axis unit if CAM data should be pulse.	When you set the main axis of CAM data as encoder, set the unit of main axis of CAM block as pulse.
710	The speed of the master axis of cam command is so high that moving position per control period exceeds the master axis scope.	After slow down the speed of the master axis then operate the axis.

Chapter 9 Positioning Error Information & Solutions

Error Code	Error Description	Solutions
711	Data area setting value (block size and no. of block) of Variable Data Read/Write command is out of range.	Set the block size and no. of block for [block size X no. of block] to be 1~128.
712	Variable Data Write command can't be executed during operation.	Check whether any axis is under operation when executing the Variable Data Write command
713	Block area of Variable Data Write command is overlapped so Writing is unavailable.	In case the number of block is more than 2, set the block set to be larger than block size. (Or set the block size to be smaller than block offset)
721	Restart is impossible, After the command that restart is not supported like Circular interpolation,	Before using restart command, check if the command that restart is not supported is used.
722	Restart command can't be executed during operation.	Check whether any axis is under operation.
801	Current module of command axis is set lager than number of possible operating axis.	Execute after set a possible operating number of command axis for current module.
811	Previous command is not processed. It is impossible to execute command additionally.	Check previous command is executed. If the process is finished, execute other command additionally

(9) H/W abnormal error

It occurs when some part are failed or damaged. If it occurs, all LED axis will be flickering 0.2second cycle. Errors below means PLC cannot operate. You can find it in XG5000 online- diagnosis- I/O information XBF- -PD04E. if the symptom continues, Enter service center or Homepage.

Error Code	Error Description	Solutions
11	RAM memory is failed in positioning module	Positioning module is normal. Enter service center, or Homepage.
13	FLASH memory is failed in positioning module	
17	Pulse output IC is failed	

Chapter 9 Positioning Error Information & Solutions

Chapter 10 Internal Memory Address of “Read/Write Variable Data” command

10.1 Parameter memory address

	Axis 1		Axis 2		Axis 3		Axis 4		
	DEC	HEX	DEC	HEX	DEC	HEX	DEC	HEX	
Basic Parameter	0	0	70	46	140	8C	210	D2	Speed limit (Low)
	1	1	71	47	141	8D	211	D3	Speed limit (High)
	2	2	72	48	142	8E	212	D4	Bias speed (Low)
	3	3	73	49	143	8F	213	D5	Bias speed (High)
	4	4	74	4A	144	90	214	D6	Acc. time1 (Low)
	5	5	75	4B	145	91	215	D7	Acc. time1 (High)
	6	6	76	4C	146	92	216	D8	Acc. time2 (Low)
	7	7	77	4D	147	93	217	D9	Acc. time2 (High)
	8	8	78	4E	148	94	218	DA	Acc. time3 (Low)
	9	9	79	4F	149	95	219	DB	Acc. time3 (High)
	10	A	80	50	150	96	220	DC	Acc. time4 (Low)
	11	B	81	51	151	97	221	DD	Acc. time4 (High)
	12	C	82	52	152	98	222	DE	Dec. time1 (Low)
	13	D	83	53	153	99	223	DF	Dec. time1 (High)
	14	E	84	54	154	9A	224	E0	Dec. time2 (Low)
	15	F	85	55	155	9B	225	E1	Dec. time2 (High)
	16	10	86	56	156	9C	226	E2	Dec. time3 (Low)
	17	11	87	57	157	9D	227	E3	Dec. time3 (High)
	18	12	88	58	158	9E	228	E4	Dec. time4 (Low)
	19	13	89	59	159	9F	229	E5	Dec. time4 (High)
	20	14	90	5A	160	A0	230	E6	Dec. time for EMG stop (Low)
	21	15	91	5B	161	A1	231	E7	Dec. time for EMG stop (High)
	22	16	92	5C	162	A2	232	E8	Pulse per rotation (Low)
	23	17	93	5D	163	A3	233	E9	Pulse per rotation (High)
	24	18	94	5E	164	A4	234	EA	Distance per rotation (Low)
	25	19	95	5F	165	A5	235	EB	Distance per rotation (High)
	26	1A	96	60	166	A6	236	EC	CONTROL WORD
27	1B	97	61	167	A7	237	ED	-	
Extended parameter	28	1C	98	62	168	A8	238	EE	SW upper limit (Low)
	29	1D	99	63	169	A9	239	EF	SW upper limit (High)
	30	1E	100	64	170	AA	240	F0	SW lower limit (Low)
	31	1F	101	65	171	AB	241	F1	SW lower limit (High)
	32	20	102	66	172	AC	242	F2	Backlash compensation
	33	21	103	67	173	AD	243	F3	Position completion time
	34	22	104	68	174	AE	244	F4	S-curve ratio
	35	23	105	69	175	AF	245	F5	Servo Alarm Reset On time
	36	24	106	6A	176	B0	246	F6	Infinite repeat position(Low)
	37	25	107	6B	177	B1	247	F7	Infinite repeat position (High)
	38	26	108	6C	178	B2	248	F8	Arc insertion position (Low)
	39	27	109	6D	179	B3	249	F9	Arc insertion position (High)
	40	28	110	6E	180	B4	250	FA	CONTROL WORD

Chapter 10 Internal Memory Address of “Read/Write Variable Data” command

	Axis 1		Axis 2		Axis 3		Axis 4		
	DEC	HEX	DEC	HEX	DEC	HEX	DEC	HEX	
Manual operation parameter	42	2A	112	70	182	B6	252	FC	JOG high speed (Low)
	43	2B	113	71	183	B7	253	FD	JOG high speed (High)
	44	2C	114	72	184	B8	254	FE	JOG low speed (Low)
	45	2D	115	73	185	B9	255	FF	JOG low speed (High)
	46	2E	116	74	186	BA	256	100	JOG acc. time (Low)
	47	2F	117	75	187	BB	257	101	JOG acc. time (High)
	48	30	118	76	188	BC	258	102	JOG dec. time (Low)
	49	31	119	77	189	BD	259	103	JOG dec. time (High)
	50	32	120	78	190	BE	260	104	Inching speed
	51	33	121	79	191	BF	261	105	-
Homing parameter	52	34	122	7A	192	C0	262	106	Home position (Low)
	53	35	123	7B	193	C1	263	107	Home position (High)
	54	36	124	7C	194	C2	264	108	Home high speed (Low)
	55	37	125	7D	195	C3	265	109	Home high speed (High)
	56	38	126	7E	196	C4	266	10A	Home low speed (Low)
	57	39	127	7F	197	C5	267	10B	Home low speed (High)
	58	3A	128	80	198	C6	268	10C	Home acc. time (Low)
	59	3B	129	81	199	C7	269	10D	Home acc. time (High)
	60	3C	130	82	200	C8	270	10E	Home dec. time (Low)
	61	3D	131	83	201	C9	271	10F	Home dec. time (High)
	62	3E	132	84	202	CA	272	110	Home compensation (Low)
	63	3F	133	85	203	CB	273	111	Home compensation (High)
	64	40	134	86	204	CC	274	112	Home restart time
	65	41	135	87	205	CD	275	113	Home dwell time
66	42	136	88	206	CE	276	114	CONTROL WORD	
67	43	137	89	207	CF	277	115	-	
I/O signal parameter	68	44	138	8A	208	D0	278	116	I/O signal parameter
	69	45	139	8B	209	D1	279	117	-
Common parameter							280	118	CONTROL WORD
							281	119	-
							282	11A	Encoder max. value (Low)
							283	11B	Encoder max. value (High)
							284	11C	Encoder min. value (Low)
							285	11D	Encoder min. value (High)
							286	11E	-
							287	11F	-
							288	120	-
						289	121	-	

Chapter 10 Internal Memory Address of “Read/Write Variable Data” command

(1) Basic parameter Control Word

Bit position	Contents
Pulse output mode (bit 0 ~ 1)	0: CW/CCW
	1: PLS/DIR
	2: PHASE
Unit (bit 2 ~ 3)	0: pulse
	1: mm
	2: inch
	3: degree
Unit multiplier (bit 4 ~ 5)	0: x1
	1: x10
	2: x100
	3: x1000
Speed command unit (bit 6)	0:Unit/Time
	1:rpm

(2) Extended parameter Control Word

Bit position	Contents
Pulse output direction (bit 0)	0: CW, 1: CCW
Acceleration/Deceleration pattern (bit 1)	0:Trapezoid operation, 1:S-Curve operation
M Code mode(bit 2 ~ 3)	0: NONE, 1: WITH, 2: AFTER
Interpolation speed selection (bit 4)	0: main axis speed, 1: synthetic speed
Software limit detection during speed control (bit 5)	0:Don't detect, 1: Detect
Reserved (bit6)	-
External stop selection (bit7)	0: Emergency stop, 1: Deceleration stop
Speed/Position switching coordinate (bit 9)	0: Incremental, 1: Absolute
Reserved (bit 10 ~ 11)	-
Infinite running repeat (bit 12)	0: Disable, 1: Enable
Interpolation continuous operation Type (bit 13)	0 : Pass target position, 1 : Pass near position
Arc insertion in 2-axis linear interpolation continuous operation (bit 14)	0 : Don't insert , 1 : Insert arc continuous operation
Pos.-specified speed override coordinate(bit 15)	0: absolute, 1: incremental

(3) Homing parameter Control Word

Bit position	Contents
Home method (bit 0 ~ 2)	0: DOG/HOME(OFF)
	1: DOG/HOME(ON)
	2: U.L. Limit/HOME
	3: DOG
	4: High speed
	5: Upper/lower limit
	6: Home
Home direction (bit 3)	0: CW
	1: CCW

Chapter 10 Internal Memory Address of “Read/Write Variable Data” command

(4) I/O signal parameter Control Word

Bit position and contents
bit0: upper limit signal bit1: lower limit signal bit2: DOG bit3: HOME
bit4: EMG signal, bit6: Driver ready signal
bit7: Servo On bit7: Servo Alarm Reset

(5) Common parameter Control Word

Bit position	Contents
Enc pulse input (bit 0 ~ 2)	0: CW/CCW (x1)
	1: PULSE/DIR (x1)
	2: PHASE A/B (x4)
Continous Operation (bit7)	0: Disable, 1: Enable
Speed override (bit 8)	0: Specify %
	1: Specify speed
Pulse output level (bit 15)	0: Low Active
	1: High Active

Chapter 10 Internal Memory Address of “Read/Write Variable Data” command

10.2 Axis 1 operation data memory address

Step	Target position		Cir. int. auxiliary point		Operation speed		Dwell time	M code	Sub. Axis setting	Helical int.	Circular int. turns	Control word
	Low	High	Low	High	Low	High						
1	290	291	292	293	294	295	296	297	298	299	300	301
2	302	303	304	305	306	307	308	309	310	311	312	313
3	314	315	316	317	318	319	320	321	322	323	324	325
4	326	327	328	329	330	331	332	333	334	335	336	337
5	338	339	340	341	342	343	344	345	346	347	348	349
6	350	351	352	353	354	355	356	357	358	359	360	361
7	362	363	364	365	366	367	368	369	370	371	372	373
8	374	375	376	377	378	379	380	381	382	383	384	385
9	386	387	388	389	390	391	392	393	394	395	396	397
10	398	399	400	401	402	403	404	405	406	407	408	409
11	410	411	412	413	414	415	416	417	418	419	420	421
12	422	423	424	425	426	427	428	429	430	431	432	433
13	434	435	436	437	438	439	440	441	442	443	444	445
14	446	447	448	449	450	451	452	453	454	455	456	457
15	458	459	460	461	462	463	464	465	466	467	468	469
16	470	471	472	473	474	475	476	477	478	479	480	481
17	482	483	484	485	486	487	488	489	490	491	492	493
18	494	495	496	497	498	499	500	501	502	503	504	505
19	506	507	508	509	510	511	512	513	514	515	516	517
20	518	519	520	521	522	523	524	525	526	527	528	529
21	530	531	532	533	534	535	536	537	538	539	540	541
22	542	543	544	545	546	547	548	549	550	551	552	553
23	554	555	556	557	558	559	560	561	562	563	564	565
24	566	567	568	569	570	571	572	573	574	575	576	577
25	578	579	580	581	582	583	584	585	586	587	588	589
26	590	591	592	593	594	595	596	597	598	599	600	601
27	602	603	604	605	606	607	608	609	610	611	612	613
28	614	615	616	617	618	619	620	621	622	623	624	625
29	626	627	628	629	630	631	632	633	634	635	636	637
30	638	639	640	641	642	643	644	645	646	647	648	649
31	650	651	652	653	654	655	656	657	658	659	660	661
32	662	663	664	665	666	667	668	669	670	671	672	673
33	674	675	676	677	678	679	680	681	682	683	684	685
34	686	687	688	689	690	691	692	693	694	695	696	697
35	698	699	700	701	702	703	704	705	706	707	708	709
36	710	711	712	713	714	715	716	717	718	719	720	721
37	722	723	724	725	726	727	728	729	730	731	732	733
38	734	735	736	737	738	739	740	741	742	743	744	745
39	746	747	748	749	750	751	752	753	754	755	756	757
40	758	759	760	761	762	763	764	765	766	767	768	769
41	770	771	772	773	774	775	776	777	778	779	780	781
42	782	783	784	785	786	787	788	789	790	791	792	793
43	794	795	796	797	798	799	800	801	802	803	804	805
44	806	807	808	809	810	811	812	813	814	815	816	817
45	818	819	820	821	822	823	824	825	826	827	828	829
46	830	831	832	833	834	835	836	837	838	839	840	841
47	842	843	844	845	846	847	848	849	850	851	852	853
48	854	855	856	857	858	859	860	861	862	863	864	865

Chapter 10 Internal Memory Address of “Read/Write Variable Data” command

Step	Target position		Cir. int. auxiliary point		Operation speed		Dwell time	M code	Sub. Axis setting	Helical int.	Circular int. turns	Control word
	Low	High	Low	High	Low	High						
49	866	867	868	869	870	871	872	873	874	875	876	877
50	878	879	880	881	882	883	884	885	886	887	888	889
51	890	891	892	893	894	895	896	897	898	899	900	901
52	902	903	904	905	906	907	908	909	910	911	912	913
53	914	915	916	917	918	919	920	921	922	923	924	925
54	926	927	928	929	930	931	932	933	934	935	936	937
55	938	939	940	941	942	943	944	945	946	947	948	949
56	950	951	952	953	954	955	956	957	958	959	960	961
57	962	963	964	965	966	967	968	969	970	971	972	973
58	974	975	976	977	978	979	980	981	982	983	984	985
59	986	987	988	989	990	991	992	993	994	995	996	997
60	998	999	1000	1001	1002	1003	1004	1005	1006	1007	1008	1009
61	1010	1011	1012	1013	1014	1015	1016	1017	1018	1019	1020	1021
62	1022	1023	1024	1025	1026	1027	1028	1029	1030	1031	1032	1033
63	1034	1035	1036	1037	1038	1039	1040	1041	1042	1043	1044	1045
64	1046	1047	1048	1049	1050	1051	1052	1053	1054	1055	1056	1057
65	1058	1059	1060	1061	1062	1063	1064	1065	1066	1067	1068	1069
66	1070	1071	1072	1073	1074	1075	1076	1077	1078	1079	1080	1081
67	1082	1083	1084	1085	1086	1087	1088	1089	1090	1091	1092	1093
68	1094	1095	1096	1097	1098	1099	1100	1101	1102	1103	1104	1105
69	1106	1107	1108	1109	1110	1111	1112	1113	1114	1115	1116	1117
70	1118	1119	1120	1121	1122	1123	1124	1125	1126	1127	1128	1129
71	1130	1131	1132	1133	1134	1135	1136	1137	1138	1139	1140	1141
72	1142	1143	1144	1145	1146	1147	1148	1149	1150	1151	1152	1153
73	1154	1155	1156	1157	1158	1159	1160	1161	1162	1163	1164	1165
74	1166	1167	1168	1169	1170	1171	1172	1173	1174	1175	1176	1177
75	1178	1179	1180	1181	1182	1183	1184	1185	1186	1187	1188	1189
76	1190	1191	1192	1193	1194	1195	1196	1197	1198	1199	1200	1201
77	1202	1203	1204	1205	1206	1207	1208	1209	1210	1211	1212	1213
78	1214	1215	1216	1217	1218	1219	1220	1221	1222	1223	1224	1225
79	1226	1227	1228	1229	1230	1231	1232	1233	1234	1235	1236	1237
80	1238	1239	1240	1241	1242	1243	1244	1245	1246	1247	1248	1249
81	1250	1251	1252	1253	1254	1255	1256	1257	1258	1259	1260	1261
82	1262	1263	1264	1265	1266	1267	1268	1269	1270	1271	1272	1273
83	1274	1275	1276	1277	1278	1279	1280	1281	1282	1283	1284	1285
84	1286	1287	1288	1289	1290	1291	1292	1293	1294	1295	1296	1297
85	1298	1299	1300	1301	1302	1303	1304	1305	1306	1307	1308	1309
86	1310	1311	1312	1313	1314	1315	1316	1317	1318	1319	1320	1321
87	1322	1323	1324	1325	1326	1327	1328	1329	1330	1331	1332	1333
88	1334	1335	1336	1337	1338	1339	1340	1341	1342	1343	1344	1345
89	1346	1347	1348	1349	1350	1351	1352	1353	1354	1355	1356	1357
90	1358	1359	1360	1361	1362	1363	1364	1365	1366	1367	1368	1369
91	1370	1371	1372	1373	1374	1375	1376	1377	1378	1379	1380	1381
92	1382	1383	1384	1385	1386	1387	1388	1389	1390	1391	1392	1393
93	1394	1395	1396	1397	1398	1399	1400	1401	1402	1403	1404	1405
94	1406	1407	1408	1409	1410	1411	1412	1413	1414	1415	1416	1417
95	1418	1419	1420	1421	1422	1423	1424	1425	1426	1427	1428	1429
96	1430	1431	1432	1433	1434	1435	1436	1437	1438	1439	1440	1441
97	1442	1443	1444	1445	1446	1447	1448	1449	1450	1451	1452	1453

Chapter 10 Internal Memory Address of “Read/Write Variable Data” command

Step	Target position		Cir. int. auxiliary point		Operation speed		Dwell time	M code	Sub. Axis setting	Helical int.	Circular int. turns	Control word
	Low	High	Low	High	Low	High						
98	1454	1455	1456	1457	1458	1459	1460	1461	1462	1463	1464	1465
99	1466	1467	1468	1469	1470	1471	1472	1473	1474	1475	1476	1477
100	1478	1479	1480	1481	1482	1483	1484	1485	1486	1487	1488	1489
101	1490	1491	1492	1493	1494	1495	1496	1497	1498	1499	1500	1501
102	1502	1503	1504	1505	1506	1507	1508	1509	1510	1511	1512	1513
103	1514	1515	1516	1517	1518	1519	1520	1521	1522	1523	1524	1525
104	1526	1527	1528	1529	1530	1531	1532	1533	1534	1535	1536	1537
105	1538	1539	1540	1541	1542	1543	1544	1545	1546	1547	1548	1549
106	1550	1551	1552	1553	1554	1555	1556	1557	1558	1559	1560	1561
107	1562	1563	1564	1565	1566	1567	1568	1569	1570	1571	1572	1573
108	1574	1575	1576	1577	1578	1579	1580	1581	1582	1583	1584	1585
109	1586	1587	1588	1589	1590	1591	1592	1593	1594	1595	1596	1597
110	1598	1599	1600	1601	1602	1603	1604	1605	1606	1607	1608	1609
111	1610	1611	1612	1613	1614	1615	1616	1617	1618	1619	1620	1621
112	1622	1623	1624	1625	1626	1627	1628	1629	1630	1631	1632	1633
113	1634	1635	1636	1637	1638	1639	1640	1641	1642	1643	1644	1645
114	1646	1647	1648	1649	1650	1651	1652	1653	1654	1655	1656	1657
115	1658	1659	1660	1661	1662	1663	1664	1665	1666	1667	1668	1669
116	1670	1671	1672	1673	1674	1675	1676	1677	1678	1679	1680	1681
117	1682	1683	1684	1685	1686	1687	1688	1689	1690	1691	1692	1693
118	1694	1695	1696	1697	1698	1699	1700	1701	1702	1703	1704	1705
119	1706	1707	1708	1709	1710	1711	1712	1713	1714	1715	1716	1717
120	1718	1719	1720	1721	1722	1723	1724	1725	1726	1727	1728	1729
121	1730	1731	1732	1733	1734	1735	1736	1737	1738	1739	1740	1741
122	1742	1743	1744	1745	1746	1747	1748	1749	1750	1751	1752	1753
123	1754	1755	1756	1757	1758	1759	1760	1761	1762	1763	1764	1765
124	1766	1767	1768	1769	1770	1771	1772	1773	1774	1775	1776	1777
125	1778	1779	1780	1781	1782	1783	1784	1785	1786	1787	1788	1789
126	1790	1791	1792	1793	1794	1795	1796	1797	1798	1799	1800	1801
127	1802	1803	1804	1805	1806	1807	1808	1809	1810	1811	1812	1813
128	1814	1815	1816	1817	1818	1819	1820	1821	1822	1823	1824	1825
129	1826	1827	1828	1829	1830	1831	1832	1833	1834	1835	1836	1837
130	1838	1839	1840	1841	1842	1843	1844	1845	1846	1847	1848	1849
131	1850	1851	1852	1853	1854	1855	1856	1857	1858	1859	1860	1861
132	1862	1863	1864	1865	1866	1867	1868	1869	1870	1871	1872	1873
133	1874	1875	1876	1877	1878	1879	1880	1881	1882	1883	1884	1885
134	1886	1887	1888	1889	1890	1891	1892	1893	1894	1895	1896	1897
135	1898	1899	1900	1901	1902	1903	1904	1905	1906	1907	1908	1909
136	1910	1911	1912	1913	1914	1915	1916	1917	1918	1919	1920	1921
137	1922	1923	1924	1925	1926	1927	1928	1929	1930	1931	1932	1933
138	1934	1935	1936	1937	1938	1939	1940	1941	1942	1943	1944	1945
139	1946	1947	1948	1949	1950	1951	1952	1953	1954	1955	1956	1957
140	1958	1959	1960	1961	1962	1963	1964	1965	1966	1967	1968	1969
141	1970	1971	1972	1973	1974	1975	1976	1977	1978	1979	1980	1981
142	1982	1983	1984	1985	1986	1987	1988	1989	1990	1991	1992	1993
143	1994	1995	1996	1997	1998	1999	2000	2001	2002	2003	2004	2005
144	2006	2007	2008	2009	2010	2011	2012	2013	2014	2015	2016	2017
145	2018	2019	2020	2021	2022	2023	2024	2025	2026	2027	2028	2029
146	2030	2031	2032	2033	2034	2035	2036	2037	2038	2039	2040	2041

Chapter 10 Internal Memory Address of “Read/Write Variable Data” command

Step	Target position		Cir. int. auxiliary point		Operation speed		Dwell time	M code	Sub. Axis setting	Helical int.	Circular int. turns	Control word
	Low	High	Low	High	Low	High						
147	2042	2043	2044	2045	2046	2047	2048	2049	2050	2051	2052	2053
148	2054	2055	2056	2057	2058	2059	2060	2061	2062	2063	2064	2065
149	2066	2067	2068	2069	2070	2071	2072	2073	2074	2075	2076	2077
150	2078	2079	2080	2081	2082	2083	2084	2085	2086	2087	2088	2089
151	2090	2091	2092	2093	2094	2095	2096	2097	2098	2099	2100	2101
152	2102	2103	2104	2105	2106	2107	2108	2109	2110	2111	2112	2113
153	2114	2115	2116	2117	2118	2119	2120	2121	2122	2123	2124	2125
154	2126	2127	2128	2129	2130	2131	2132	2133	2134	2135	2136	2137
155	2138	2139	2140	2141	2142	2143	2144	2145	2146	2147	2148	2149
156	2150	2151	2152	2153	2154	2155	2156	2157	2158	2159	2160	2161
157	2162	2163	2164	2165	2166	2167	2168	2169	2170	2171	2172	2173
158	2174	2175	2176	2177	2178	2179	2180	2181	2182	2183	2184	2185
159	2186	2187	2188	2189	2190	2191	2192	2193	2194	2195	2196	2197
160	2198	2199	2200	2201	2202	2203	2204	2205	2206	2207	2208	2209
161	2210	2211	2212	2213	2214	2215	2216	2217	2218	2219	2220	2221
162	2222	2223	2224	2225	2226	2227	2228	2229	2230	2231	2232	2233
163	2234	2235	2236	2237	2238	2239	2240	2241	2242	2243	2244	2245
164	2246	2247	2248	2249	2250	2251	2252	2253	2254	2255	2256	2257
165	2258	2259	2260	2261	2262	2263	2264	2265	2266	2267	2268	2269
166	2270	2271	2272	2273	2274	2275	2276	2277	2278	2279	2280	2281
167	2282	2283	2284	2285	2286	2287	2288	2289	2290	2291	2292	2293
168	2294	2295	2296	2297	2298	2299	2300	2301	2302	2303	2304	2305
169	2306	2307	2308	2309	2310	2311	2312	2313	2314	2315	2316	2317
170	2318	2319	2320	2321	2322	2323	2324	2325	2326	2327	2328	2329
171	2330	2331	2332	2333	2334	2335	2336	2337	2338	2339	2340	2341
172	2342	2343	2344	2345	2346	2347	2348	2349	2350	2351	2352	2353
173	2354	2355	2356	2357	2358	2359	2360	2361	2362	2363	2364	2365
174	2366	2367	2368	2369	2370	2371	2372	2373	2374	2375	2376	2377
175	2378	2379	2380	2381	2382	2383	2384	2385	2386	2387	2388	2389
176	2390	2391	2392	2393	2394	2395	2396	2397	2398	2399	2400	2401
177	2402	2403	2404	2405	2406	2407	2408	2409	2410	2411	2412	2413
178	2414	2415	2416	2417	2418	2419	2420	2421	2422	2423	2424	2425
179	2426	2427	2428	2429	2430	2431	2432	2433	2434	2435	2436	2437
180	2438	2439	2440	2441	2442	2443	2444	2445	2446	2447	2448	2449
181	2450	2451	2452	2453	2454	2455	2456	2457	2458	2459	2460	2461
182	2462	2463	2464	2465	2466	2467	2468	2469	2470	2471	2472	2473
183	2474	2475	2476	2477	2478	2479	2480	2481	2482	2483	2484	2485
184	2486	2487	2488	2489	2490	2491	2492	2493	2494	2495	2496	2497
185	2498	2499	2500	2501	2502	2503	2504	2505	2506	2507	2508	2509
186	2510	2511	2512	2513	2514	2515	2516	2517	2518	2519	2520	2521
187	2522	2523	2524	2525	2526	2527	2528	2529	2530	2531	2532	2533
188	2534	2535	2536	2537	2538	2539	2540	2541	2542	2543	2544	2545
189	2546	2547	2548	2549	2550	2551	2552	2553	2554	2555	2556	2557
190	2558	2559	2560	2561	2562	2563	2564	2565	2566	2567	2568	2569
191	2570	2571	2572	2573	2574	2575	2576	2577	2578	2579	2580	2581
192	2582	2583	2584	2585	2586	2587	2588	2589	2590	2591	2592	2593
193	2594	2595	2596	2597	2598	2599	2600	2601	2602	2603	2604	2605
194	2606	2607	2608	2609	2610	2611	2612	2613	2614	2615	2616	2617
195	2618	2619	2620	2621	2622	2623	2624	2625	2626	2627	2628	2629

Chapter 10 Internal Memory Address of “Read/Write Variable Data” command

Step	Target position		Cir. int. auxiliary point		Operation speed		Dwell time	M code	Sub. Axis setting	Helical int.	Circular int. turns	Control word
	Low	High	Low	High	Low	High						
196	2630	2631	2632	2633	2634	2635	2636	2637	2638	2639	2640	2641
197	2642	2643	2644	2645	2646	2647	2648	2649	2650	2651	2652	2653
198	2654	2655	2656	2657	2658	2659	2660	2661	2662	2663	2664	2665
199	2666	2667	2668	2669	2670	2671	2672	2673	2674	2675	2676	2677
200	2678	2679	2680	2681	2682	2683	2684	2685	2686	2687	2688	2689
201	2690	2691	2692	2693	2694	2695	2696	2697	2698	2699	2700	2701
202	2702	2703	2704	2705	2706	2707	2708	2709	2710	2711	2712	2713
203	2714	2715	2716	2717	2718	2719	2720	2721	2722	2723	2724	2725
204	2726	2727	2728	2729	2730	2731	2732	2733	2734	2735	2736	2737
205	2738	2739	2740	2741	2742	2743	2744	2745	2746	2747	2748	2749
206	2750	2751	2752	2753	2754	2755	2756	2757	2758	2759	2760	2761
207	2762	2763	2764	2765	2766	2767	2768	2769	2770	2771	2772	2773
208	2774	2775	2776	2777	2778	2779	2780	2781	2782	2783	2784	2785
209	2786	2787	2788	2789	2790	2791	2792	2793	2794	2795	2796	2797
210	2798	2799	2800	2801	2802	2803	2804	2805	2806	2807	2808	2809
211	2810	2811	2812	2813	2814	2815	2816	2817	2818	2819	2820	2821
212	2822	2823	2824	2825	2826	2827	2828	2829	2830	2831	2832	2833
213	2834	2835	2836	2837	2838	2839	2840	2841	2842	2843	2844	2845
214	2846	2847	2848	2849	2850	2851	2852	2853	2854	2855	2856	2857
215	2858	2859	2860	2861	2862	2863	2864	2865	2866	2867	2868	2869
216	2870	2871	2872	2873	2874	2875	2876	2877	2878	2879	2880	2881
217	2882	2883	2884	2885	2886	2887	2888	2889	2890	2891	2892	2893
218	2894	2895	2896	2897	2898	2899	2900	2901	2902	2903	2904	2905
219	2906	2907	2908	2909	2910	2911	2912	2913	2914	2915	2916	2917
220	2918	2919	2920	2921	2922	2923	2924	2925	2926	2927	2928	2929
221	2930	2931	2932	2933	2934	2935	2936	2937	2938	2939	2940	2941
222	2942	2943	2944	2945	2946	2947	2948	2949	2950	2951	2952	2953
223	2954	2955	2956	2957	2958	2959	2960	2961	2962	2963	2964	2965
224	2966	2967	2968	2969	2970	2971	2972	2973	2974	2975	2976	2977
225	2978	2979	2980	2981	2982	2983	2984	2985	2986	2987	2988	2989
226	2990	2991	2992	2993	2994	2995	2996	2997	2998	2999	3000	3001
227	3002	3003	3004	3005	3006	3007	3008	3009	3010	3011	3012	3013
228	3014	3015	3016	3017	3018	3019	3020	3021	3022	3023	3024	3025
229	3026	3027	3028	3029	3030	3031	3032	3033	3034	3035	3036	3037
230	3038	3039	3040	3041	3042	3043	3044	3045	3046	3047	3048	3049
231	3050	3051	3052	3053	3054	3055	3056	3057	3058	3059	3060	3061
232	3062	3063	3064	3065	3066	3067	3068	3069	3070	3071	3072	3073
233	3074	3075	3076	3077	3078	3079	3080	3081	3082	3083	3084	3085
234	3086	3087	3088	3089	3090	3091	3092	3093	3094	3095	3096	3097
235	3098	3099	3100	3101	3102	3103	3104	3105	3106	3107	3108	3109
236	3110	3111	3112	3113	3114	3115	3116	3117	3118	3119	3120	3121
237	3122	3123	3124	3125	3126	3127	3128	3129	3130	3131	3132	3133
238	3134	3135	3136	3137	3138	3139	3140	3141	3142	3143	3144	3145
239	3146	3147	3148	3149	3150	3151	3152	3153	3154	3155	3156	3157
240	3158	3159	3160	3161	3162	3163	3164	3165	3166	3167	3168	3169
241	3170	3171	3172	3173	3174	3175	3176	3177	3178	3179	3180	3181
242	3182	3183	3184	3185	3186	3187	3188	3189	3190	3191	3192	3193
243	3194	3195	3196	3197	3198	3199	3200	3201	3202	3203	3204	3205
244	3206	3207	3208	3209	3210	3211	3212	3213	3214	3215	3216	3217

Chapter 10 Internal Memory Address of “Read/Write Variable Data” command

Step	Target position		Cir. int. auxiliary point		Operation speed		Dwell time	M code	Sub. Axis setting	Helical int.	Circular int. turns	Control word
	Low	High	Low	High	Low	High						
245	3218	3219	3220	3221	3222	3223	3224	3225	3226	3227	3228	3229
246	3230	3231	3232	3233	3234	3235	3236	3237	3238	3239	3240	3241
247	3242	3243	3244	3245	3246	3247	3248	3249	3250	3251	3252	3253
248	3254	3255	3256	3257	3258	3259	3260	3261	3262	3263	3264	3265
249	3266	3267	3268	3269	3270	3271	3272	3273	3274	3275	3276	3277
250	3278	3279	3280	3281	3282	3283	3284	3285	3286	3287	3288	3289
251	3290	3291	3292	3293	3294	3295	3296	3297	3298	3299	3300	3301
252	3302	3303	3304	3305	3306	3307	3308	3309	3310	3311	3312	3313
253	3314	3315	3316	3317	3318	3319	3320	3321	3322	3323	3324	3325
254	3326	3327	3328	3329	3330	3331	3332	3333	3334	3335	3336	3337
255	3338	3339	3340	3341	3342	3343	3344	3345	3346	3347	3348	3349
256	3350	3351	3352	3353	3354	3355	3356	3357	3358	3359	3360	3361
257	3362	3363	3364	3365	3366	3367	3368	3369	3370	3371	3372	3373
258	3374	3375	3376	3377	3378	3379	3380	3381	3382	3383	3384	3385
259	3386	3387	3388	3389	3390	3391	3392	3393	3394	3395	3396	3397
260	3398	3399	3400	3401	3402	3403	3404	3405	3406	3407	3408	3409
261	3410	3411	3412	3413	3414	3415	3416	3417	3418	3419	3420	3421
262	3422	3423	3424	3425	3426	3427	3428	3429	3430	3431	3432	3433
263	3434	3435	3436	3437	3438	3439	3440	3441	3442	3443	3444	3445
264	3446	3447	3448	3449	3450	3451	3452	3453	3454	3455	3456	3457
265	3458	3459	3460	3461	3462	3463	3464	3465	3466	3467	3468	3469
266	3470	3471	3472	3473	3474	3475	3476	3477	3478	3479	3480	3481
267	3482	3483	3484	3485	3486	3487	3488	3489	3490	3491	3492	3493
268	3494	3495	3496	3497	3498	3499	3500	3501	3502	3503	3504	3505
269	3506	3507	3508	3509	3510	3511	3512	3513	3514	3515	3516	3517
270	3518	3519	3520	3521	3522	3523	3524	3525	3526	3527	3528	3529
271	3530	3531	3532	3533	3534	3535	3536	3537	3538	3539	3540	3541
272	3542	3543	3544	3545	3546	3547	3548	3549	3550	3551	3552	3553
273	3554	3555	3556	3557	3558	3559	3560	3561	3562	3563	3564	3565
274	3566	3567	3568	3569	3570	3571	3572	3573	3574	3575	3576	3577
275	3578	3579	3580	3581	3582	3583	3584	3585	3586	3587	3588	3589
276	3590	3591	3592	3593	3594	3595	3596	3597	3598	3599	3600	3601
277	3602	3603	3604	3605	3606	3607	3608	3609	3610	3611	3612	3613
278	3614	3615	3616	3617	3618	3619	3620	3621	3622	3623	3624	3625
279	3626	3627	3628	3629	3630	3631	3632	3633	3634	3635	3636	3637
280	3638	3639	3640	3641	3642	3643	3644	3645	3646	3647	3648	3649
281	3650	3651	3652	3653	3654	3655	3656	3657	3658	3659	3660	3661
282	3662	3663	3664	3665	3666	3667	3668	3669	3670	3671	3672	3673
283	3674	3675	3676	3677	3678	3679	3680	3681	3682	3683	3684	3685
284	3686	3687	3688	3689	3690	3691	3692	3693	3694	3695	3696	3697
285	3698	3699	3700	3701	3702	3703	3704	3705	3706	3707	3708	3709
286	3710	3711	3712	3713	3714	3715	3716	3717	3718	3719	3720	3721
287	3722	3723	3724	3725	3726	3727	3728	3729	3730	3731	3732	3733
288	3734	3735	3736	3737	3738	3739	3740	3741	3742	3743	3744	3745
289	3746	3747	3748	3749	3750	3751	3752	3753	3754	3755	3756	3757
290	3758	3759	3760	3761	3762	3763	3764	3765	3766	3767	3768	3769
291	3770	3771	3772	3773	3774	3775	3776	3777	3778	3779	3780	3781
292	3782	3783	3784	3785	3786	3787	3788	3789	3790	3791	3792	3793
293	3794	3795	3796	3797	3798	3799	3800	3801	3802	3803	3804	3805

Chapter 10 Internal Memory Address of “Read/Write Variable Data” command

Step	Target position		Cir. int. auxiliary point		Operation speed		Dwell time	M code	Sub. Axis setting	Helical int.	Circular int. turns	Control word
	Low	High	Low	High	Low	High						
294	3806	3807	3808	3809	3810	3811	3812	3813	3814	3815	3816	3817
295	3818	3819	3820	3821	3822	3823	3824	3825	3826	3827	3828	3829
296	3830	3831	3832	3833	3834	3835	3836	3837	3838	3839	3840	3841
297	3842	3843	3844	3845	3846	3847	3848	3849	3850	3851	3852	3853
298	3854	3855	3856	3857	3858	3859	3860	3861	3862	3863	3864	3865
299	3866	3867	3868	3869	3870	3871	3872	3873	3874	3875	3876	3877
300	3878	3879	3880	3881	3882	3883	3884	3885	3886	3887	3888	3889
301	3890	3891	3892	3893	3894	3895	3896	3897	3898	3899	3900	3901
302	3902	3903	3904	3905	3906	3907	3908	3909	3910	3911	3912	3913
303	3914	3915	3916	3917	3918	3919	3920	3921	3922	3923	3924	3925
304	3926	3927	3928	3929	3930	3931	3932	3933	3934	3935	3936	3937
305	3938	3939	3940	3941	3942	3943	3944	3945	3946	3947	3948	3949
306	3950	3951	3952	3953	3954	3955	3956	3957	3958	3959	3960	3961
307	3962	3963	3964	3965	3966	3967	3968	3969	3970	3971	3972	3973
308	3974	3975	3976	3977	3978	3979	3980	3981	3982	3983	3984	3985
309	3986	3987	3988	3989	3990	3991	3992	3993	3994	3995	3996	3997
310	3998	3999	4000	4001	4002	4003	4004	4005	4006	4007	4008	4009
311	4010	4011	4012	4013	4014	4015	4016	4017	4018	4019	4020	4021
312	4022	4023	4024	4025	4026	4027	4028	4029	4030	4031	4032	4033
313	4034	4035	4036	4037	4038	4039	4040	4041	4042	4043	4044	4045
314	4046	4047	4048	4049	4050	4051	4052	4053	4054	4055	4056	4057
315	4058	4059	4060	4061	4062	4063	4064	4065	4066	4067	4068	4069
316	4070	4071	4072	4073	4074	4075	4076	4077	4078	4079	4080	4081
317	4082	4083	4084	4085	4086	4087	4088	4089	4090	4091	4092	4093
318	4094	4095	4096	4097	4098	4099	4100	4101	4102	4103	4104	4105
319	4106	4107	4108	4109	4110	4111	4112	4113	4114	4115	4116	4117
320	4118	4119	4120	4121	4122	4123	4124	4125	4126	4127	4128	4129
321	4130	4131	4132	4133	4134	4135	4136	4137	4138	4139	4140	4141
322	4142	4143	4144	4145	4146	4147	4148	4149	4150	4151	4152	4153
323	4154	4155	4156	4157	4158	4159	4160	4161	4162	4163	4164	4165
324	4166	4167	4168	4169	4170	4171	4172	4173	4174	4175	4176	4177
325	4178	4179	4180	4181	4182	4183	4184	4185	4186	4187	4188	4189
326	4190	4191	4192	4193	4194	4195	4196	4197	4198	4199	4200	4201
327	4202	4203	4204	4205	4206	4207	4208	4209	4210	4211	4212	4213
328	4214	4215	4216	4217	4218	4219	4220	4221	4222	4223	4224	4225
329	4226	4227	4228	4229	4230	4231	4232	4233	4234	4235	4236	4237
330	4238	4239	4240	4241	4242	4243	4244	4245	4246	4247	4248	4249
331	4250	4251	4252	4253	4254	4255	4256	4257	4258	4259	4260	4261
332	4262	4263	4264	4265	4266	4267	4268	4269	4270	4271	4272	4273
333	4274	4275	4276	4277	4278	4279	4280	4281	4282	4283	4284	4285
334	4286	4287	4288	4289	4290	4291	4292	4293	4294	4295	4296	4297
335	4298	4299	4300	4301	4302	4303	4304	4305	4306	4307	4308	4309
336	4310	4311	4312	4313	4314	4315	4316	4317	4318	4319	4320	4321
337	4322	4323	4324	4325	4326	4327	4328	4329	4330	4331	4332	4333
338	4334	4335	4336	4337	4338	4339	4340	4341	4342	4343	4344	4345
339	4346	4347	4348	4349	4350	4351	4352	4353	4354	4355	4356	4357
340	4358	4359	4360	4361	4362	4363	4364	4365	4366	4367	4368	4369
341	4370	4371	4372	4373	4374	4375	4376	4377	4378	4379	4380	4381
342	4382	4383	4384	4385	4386	4387	4388	4389	4390	4391	4392	4393

Chapter 10 Internal Memory Address of “Read/Write Variable Data” command

Step	Target position		Cir. int. auxiliary point		Operation speed		Dwell time	M code	Sub. Axis setting	Helical int.	Circular int. turns	Control word
	Low	High	Low	High	Low	High						
343	4394	4395	4396	4397	4398	4399	4400	4401	4402	4403	4404	4405
344	4406	4407	4408	4409	4410	4411	4412	4413	4414	4415	4416	4417
345	4418	4419	4420	4421	4422	4423	4424	4425	4426	4427	4428	4429
346	4430	4431	4432	4433	4434	4435	4436	4437	4438	4439	4440	4441
347	4442	4443	4444	4445	4446	4447	4448	4449	4450	4451	4452	4453
348	4454	4455	4456	4457	4458	4459	4460	4461	4462	4463	4464	4465
349	4466	4467	4468	4469	4470	4471	4472	4473	4474	4475	4476	4477
350	4478	4479	4480	4481	4482	4483	4484	4485	4486	4487	4488	4489
351	4490	4491	4492	4493	4494	4495	4496	4497	4498	4499	4500	4501
352	4502	4503	4504	4505	4506	4507	4508	4509	4510	4511	4512	4513
353	4514	4515	4516	4517	4518	4519	4520	4521	4522	4523	4524	4525
354	4526	4527	4528	4529	4530	4531	4532	4533	4534	4535	4536	4537
355	4538	4539	4540	4541	4542	4543	4544	4545	4546	4547	4548	4549
356	4550	4551	4552	4553	4554	4555	4556	4557	4558	4559	4560	4561
357	4562	4563	4564	4565	4566	4567	4568	4569	4570	4571	4572	4573
358	4574	4575	4576	4577	4578	4579	4580	4581	4582	4583	4584	4585
359	4586	4587	4588	4589	4590	4591	4592	4593	4594	4595	4596	4597
360	4598	4599	4600	4601	4602	4603	4604	4605	4606	4607	4608	4609
361	4610	4611	4612	4613	4614	4615	4616	4617	4618	4619	4620	4621
362	4622	4623	4624	4625	4626	4627	4628	4629	4630	4631	4632	4633
363	4634	4635	4636	4637	4638	4639	4640	4641	4642	4643	4644	4645
364	4646	4647	4648	4649	4650	4651	4652	4653	4654	4655	4656	4657
365	4658	4659	4660	4661	4662	4663	4664	4665	4666	4667	4668	4669
366	4670	4671	4672	4673	4674	4675	4676	4677	4678	4679	4680	4681
367	4682	4683	4684	4685	4686	4687	4688	4689	4690	4691	4692	4693
368	4694	4695	4696	4697	4698	4699	4700	4701	4702	4703	4704	4705
369	4706	4707	4708	4709	4710	4711	4712	4713	4714	4715	4716	4717
370	4718	4719	4720	4721	4722	4723	4724	4725	4726	4727	4728	4729
371	4730	4731	4732	4733	4734	4735	4736	4737	4738	4739	4740	4741
372	4742	4743	4744	4745	4746	4747	4748	4749	4750	4751	4752	4753
373	4754	4755	4756	4757	4758	4759	4760	4761	4762	4763	4764	4765
374	4766	4767	4768	4769	4770	4771	4772	4773	4774	4775	4776	4777
375	4778	4779	4780	4781	4782	4783	4784	4785	4786	4787	4788	4789
376	4790	4791	4792	4793	4794	4795	4796	4797	4798	4799	4800	4801
377	4802	4803	4804	4805	4806	4807	4808	4809	4810	4811	4812	4813
378	4814	4815	4816	4817	4818	4819	4820	4821	4822	4823	4824	4825
379	4826	4827	4828	4829	4830	4831	4832	4833	4834	4835	4836	4837
380	4838	4839	4840	4841	4842	4843	4844	4845	4846	4847	4848	4849
381	4850	4851	4852	4853	4854	4855	4856	4857	4858	4859	4860	4861
382	4862	4863	4864	4865	4866	4867	4868	4869	4870	4871	4872	4873
383	4874	4875	4876	4877	4878	4879	4880	4881	4882	4883	4884	4885
384	4886	4887	4888	4889	4890	4891	4892	4893	4894	4895	4896	4897
385	4898	4899	4900	4901	4902	4903	4904	4905	4906	4907	4908	4909
386	4910	4911	4912	4913	4914	4915	4916	4917	4918	4919	4920	4921
387	4922	4923	4924	4925	4926	4927	4928	4929	4930	4931	4932	4933
388	4934	4935	4936	4937	4938	4939	4940	4941	4942	4943	4944	4945
389	4946	4947	4948	4949	4950	4951	4952	4953	4954	4955	4956	4957
390	4958	4959	4960	4961	4962	4963	4964	4965	4966	4967	4968	4969
391	4970	4971	4972	4973	4974	4975	4976	4977	4978	4979	4980	4981

Chapter 10 Internal Memory Address of “Read/Write Variable Data” command

Step	Target position		Cir. int. auxiliary point		Operation speed		Dwell time	M code	Sub. Axis setting	Helical int.	Circular int. turns	Control word
	Low	High	Low	High	Low	High						
392	4982	4983	4984	4985	4986	4987	4988	4989	4990	4991	4992	4993
393	4994	4995	4996	4997	4998	4999	5000	5001	5002	5003	5004	5005
394	5006	5007	5008	5009	5010	5011	5012	5013	5014	5015	5016	5017
395	5018	5019	5020	5021	5022	5023	5024	5025	5026	5027	5028	5029
396	5030	5031	5032	5033	5034	5035	5036	5037	5038	5039	5040	5041
397	5042	5043	5044	5045	5046	5047	5048	5049	5050	5051	5052	5053
398	5054	5055	5056	5057	5058	5059	5060	5061	5062	5063	5064	5065
399	5066	5067	5068	5069	5070	5071	5072	5073	5074	5075	5076	5077
400	5078	5079	5080	5081	5082	5083	5084	5085	5086	5087	5088	5089

Chapter 10 Internal Memory Address of “Read/Write Variable Data” command

10.3 Axis 2 operation data memory address

Step	Target position		Cir. int. auxiliary point		Operation speed		Dwell time	M code	Sub. Axis setting	Helical int.	Circular int. turns	Control word
	Low	High	Low	High	Low	High						
1	5090	5091	5092	5093	5094	5095	5096	5097	5098	5099	5100	5101
2	5102	5103	5104	5105	5106	5107	5108	5109	5110	5111	5112	5113
3	5114	5115	5116	5117	5118	5119	5120	5121	5122	5123	5124	5125
4	5126	5127	5128	5129	5130	5131	5132	5133	5134	5135	5136	5137
5	5138	5139	5140	5141	5142	5143	5144	5145	5146	5147	5148	5149
6	5150	5151	5152	5153	5154	5155	5156	5157	5158	5159	5160	5161
7	5162	5163	5164	5165	5166	5167	5168	5169	5170	5171	5172	5173
8	5174	5175	5176	5177	5178	5179	5180	5181	5182	5183	5184	5185
9	5186	5187	5188	5189	5190	5191	5192	5193	5194	5195	5196	5197
10	5198	5199	5200	5201	5202	5203	5204	5205	5206	5207	5208	5209
11	5210	5211	5212	5213	5214	5215	5216	5217	5218	5219	5220	5221
12	5222	5223	5224	5225	5226	5227	5228	5229	5230	5231	5232	5233
13	5234	5235	5236	5237	5238	5239	5240	5241	5242	5243	5244	5245
14	5246	5247	5248	5249	5250	5251	5252	5253	5254	5255	5256	5257
15	5258	5259	5260	5261	5262	5263	5264	5265	5266	5267	5268	5269
16	5270	5271	5272	5273	5274	5275	5276	5277	5278	5279	5280	5281
17	5282	5283	5284	5285	5286	5287	5288	5289	5290	5291	5292	5293
18	5294	5295	5296	5297	5298	5299	5300	5301	5302	5303	5304	5305
19	5306	5307	5308	5309	5310	5311	5312	5313	5314	5315	5316	5317
20	5318	5319	5320	5321	5322	5323	5324	5325	5326	5327	5328	5329
21	5330	5331	5332	5333	5334	5335	5336	5337	5338	5339	5340	5341
22	5342	5343	5344	5345	5346	5347	5348	5349	5350	5351	5352	5353
23	5354	5355	5356	5357	5358	5359	5360	5361	5362	5363	5364	5365
24	5366	5367	5368	5369	5370	5371	5372	5373	5374	5375	5376	5377
25	5378	5379	5380	5381	5382	5383	5384	5385	5386	5387	5388	5389
26	5390	5391	5392	5393	5394	5395	5396	5397	5398	5399	5400	5401
27	5402	5403	5404	5405	5406	5407	5408	5409	5410	5411	5412	5413
28	5414	5415	5416	5417	5418	5419	5420	5421	5422	5423	5424	5425
29	5426	5427	5428	5429	5430	5431	5432	5433	5434	5435	5436	5437
30	5438	5439	5440	5441	5442	5443	5444	5445	5446	5447	5448	5449
31	5450	5451	5452	5453	5454	5455	5456	5457	5458	5459	5460	5461
32	5462	5463	5464	5465	5466	5467	5468	5469	5470	5471	5472	5473
33	5474	5475	5476	5477	5478	5479	5480	5481	5482	5483	5484	5485
34	5486	5487	5488	5489	5490	5491	5492	5493	5494	5495	5496	5497
35	5498	5499	5500	5501	5502	5503	5504	5505	5506	5507	5508	5509
36	5510	5511	5512	5513	5514	5515	5516	5517	5518	5519	5520	5521
37	5522	5523	5524	5525	5526	5527	5528	5529	5530	5531	5532	5533
38	5534	5535	5536	5537	5538	5539	5540	5541	5542	5543	5544	5545
39	5546	5547	5548	5549	5550	5551	5552	5553	5554	5555	5556	5557
40	5558	5559	5560	5561	5562	5563	5564	5565	5566	5567	5568	5569
41	5570	5571	5572	5573	5574	5575	5576	5577	5578	5579	5580	5581
42	5582	5583	5584	5585	5586	5587	5588	5589	5590	5591	5592	5593
43	5594	5595	5596	5597	5598	5599	5600	5601	5602	5603	5604	5605
44	5606	5607	5608	5609	5610	5611	5612	5613	5614	5615	5616	5617
45	5618	5619	5620	5621	5622	5623	5624	5625	5626	5627	5628	5629
46	5630	5631	5632	5633	5634	5635	5636	5637	5638	5639	5640	5641
47	5642	5643	5644	5645	5646	5647	5648	5649	5650	5651	5652	5653

Chapter 10 Internal Memory Address of “Read/Write Variable Data” command

Step	Target position		Cir. int. auxiliary point		Operation speed		Dwell time	M code	Sub. Axis setting	Helical int.	Circular int. turns	Control word
	Low	High	Low	High	Low	High						
48	5654	5655	5656	5657	5658	5659	5660	5661	5662	5663	5664	5665
49	5666	5667	5668	5669	5670	5671	5672	5673	5674	5675	5676	5677
50	5678	5679	5680	5681	5682	5683	5684	5685	5686	5687	5688	5689
51	5690	5691	5692	5693	5694	5695	5696	5697	5698	5699	5700	5701
52	5702	5703	5704	5705	5706	5707	5708	5709	5710	5711	5712	5713
53	5714	5715	5716	5717	5718	5719	5720	5721	5722	5723	5724	5725
54	5726	5727	5728	5729	5730	5731	5732	5733	5734	5735	5736	5737
55	5738	5739	5740	5741	5742	5743	5744	5745	5746	5747	5748	5749
56	5750	5751	5752	5753	5754	5755	5756	5757	5758	5759	5760	5761
57	5762	5763	5764	5765	5766	5767	5768	5769	5770	5771	5772	5773
58	5774	5775	5776	5777	5778	5779	5780	5781	5782	5783	5784	5785
59	5786	5787	5788	5789	5790	5791	5792	5793	5794	5795	5796	5797
60	5798	5799	5800	5801	5802	5803	5804	5805	5806	5807	5808	5809
61	5810	5811	5812	5813	5814	5815	5816	5817	5818	5819	5820	5821
62	5822	5823	5824	5825	5826	5827	5828	5829	5830	5831	5832	5833
63	5834	5835	5836	5837	5838	5839	5840	5841	5842	5843	5844	5845
64	5846	5847	5848	5849	5850	5851	5852	5853	5854	5855	5856	5857
65	5858	5859	5860	5861	5862	5863	5864	5865	5866	5867	5868	5869
66	5870	5871	5872	5873	5874	5875	5876	5877	5878	5879	5880	5881
67	5882	5883	5884	5885	5886	5887	5888	5889	5890	5891	5892	5893
68	5894	5895	5896	5897	5898	5899	5900	5901	5902	5903	5904	5905
69	5906	5907	5908	5909	5910	5911	5912	5913	5914	5915	5916	5917
70	5918	5919	5920	5921	5922	5923	5924	5925	5926	5927	5928	5929
71	5930	5931	5932	5933	5934	5935	5936	5937	5938	5939	5940	5941
72	5942	5943	5944	5945	5946	5947	5948	5949	5950	5951	5952	5953
73	5954	5955	5956	5957	5958	5959	5960	5961	5962	5963	5964	5965
74	5966	5967	5968	5969	5970	5971	5972	5973	5974	5975	5976	5977
75	5978	5979	5980	5981	5982	5983	5984	5985	5986	5987	5988	5989
76	5990	5991	5992	5993	5994	5995	5996	5997	5998	5999	6000	6001
77	6002	6003	6004	6005	6006	6007	6008	6009	6010	6011	6012	6013
78	6014	6015	6016	6017	6018	6019	6020	6021	6022	6023	6024	6025
79	6026	6027	6028	6029	6030	6031	6032	6033	6034	6035	6036	6037
80	6038	6039	6040	6041	6042	6043	6044	6045	6046	6047	6048	6049
81	6050	6051	6052	6053	6054	6055	6056	6057	6058	6059	6060	6061
82	6062	6063	6064	6065	6066	6067	6068	6069	6070	6071	6072	6073
83	6074	6075	6076	6077	6078	6079	6080	6081	6082	6083	6084	6085
84	6086	6087	6088	6089	6090	6091	6092	6093	6094	6095	6096	6097
85	6098	6099	6100	6101	6102	6103	6104	6105	6106	6107	6108	6109
86	6110	6111	6112	6113	6114	6115	6116	6117	6118	6119	6120	6121
87	6122	6123	6124	6125	6126	6127	6128	6129	6130	6131	6132	6133
88	6134	6135	6136	6137	6138	6139	6140	6141	6142	6143	6144	6145
89	6146	6147	6148	6149	6150	6151	6152	6153	6154	6155	6156	6157
90	6158	6159	6160	6161	6162	6163	6164	6165	6166	6167	6168	6169
91	6170	6171	6172	6173	6174	6175	6176	6177	6178	6179	6180	6181
92	6182	6183	6184	6185	6186	6187	6188	6189	6190	6191	6192	6193
93	6194	6195	6196	6197	6198	6199	6200	6201	6202	6203	6204	6205
94	6206	6207	6208	6209	6210	6211	6212	6213	6214	6215	6216	6217
95	6218	6219	6220	6221	6222	6223	6224	6225	6226	6227	6228	6229
96	6230	6231	6232	6233	6234	6235	6236	6237	6238	6239	6240	6241

Chapter 10 Internal Memory Address of “Read/Write Variable Data” command

Step	Target position		Cir. int. auxiliary point		Operation speed		Dwell time	M code	Sub. Axis setting	Helical int.	Circular int. turns	Control word
	Low	High	Low	High	Low	High						
97	6242	6243	6244	6245	6246	6247	6248	6249	6250	6251	6252	6253
98	6254	6255	6256	6257	6258	6259	6260	6261	6262	6263	6264	6265
99	6266	6267	6268	6269	6270	6271	6272	6273	6274	6275	6276	6277
100	6278	6279	6280	6281	6282	6283	6284	6285	6286	6287	6288	6289
101	6290	6291	6292	6293	6294	6295	6296	6297	6298	6299	6300	6301
102	6302	6303	6304	6305	6306	6307	6308	6309	6310	6311	6312	6313
103	6314	6315	6316	6317	6318	6319	6320	6321	6322	6323	6324	6325
104	6326	6327	6328	6329	6330	6331	6332	6333	6334	6335	6336	6337
105	6338	6339	6340	6341	6342	6343	6344	6345	6346	6347	6348	6349
106	6350	6351	6352	6353	6354	6355	6356	6357	6358	6359	6360	6361
107	6362	6363	6364	6365	6366	6367	6368	6369	6370	6371	6372	6373
108	6374	6375	6376	6377	6378	6379	6380	6381	6382	6383	6384	6385
109	6386	6387	6388	6389	6390	6391	6392	6393	6394	6395	6396	6397
110	6398	6399	6400	6401	6402	6403	6404	6405	6406	6407	6408	6409
111	6410	6411	6412	6413	6414	6415	6416	6417	6418	6419	6420	6421
112	6422	6423	6424	6425	6426	6427	6428	6429	6430	6431	6432	6433
113	6434	6435	6436	6437	6438	6439	6440	6441	6442	6443	6444	6445
114	6446	6447	6448	6449	6450	6451	6452	6453	6454	6455	6456	6457
115	6458	6459	6460	6461	6462	6463	6464	6465	6466	6467	6468	6469
116	6470	6471	6472	6473	6474	6475	6476	6477	6478	6479	6480	6481
117	6482	6483	6484	6485	6486	6487	6488	6489	6490	6491	6492	6493
118	6494	6495	6496	6497	6498	6499	6500	6501	6502	6503	6504	6505
119	6506	6507	6508	6509	6510	6511	6512	6513	6514	6515	6516	6517
120	6518	6519	6520	6521	6522	6523	6524	6525	6526	6527	6528	6529
121	6530	6531	6532	6533	6534	6535	6536	6537	6538	6539	6540	6541
122	6542	6543	6544	6545	6546	6547	6548	6549	6550	6551	6552	6553
123	6554	6555	6556	6557	6558	6559	6560	6561	6562	6563	6564	6565
124	6566	6567	6568	6569	6570	6571	6572	6573	6574	6575	6576	6577
125	6578	6579	6580	6581	6582	6583	6584	6585	6586	6587	6588	6589
126	6590	6591	6592	6593	6594	6595	6596	6597	6598	6599	6600	6601
127	6602	6603	6604	6605	6606	6607	6608	6609	6610	6611	6612	6613
128	6614	6615	6616	6617	6618	6619	6620	6621	6622	6623	6624	6625
129	6626	6627	6628	6629	6630	6631	6632	6633	6634	6635	6636	6637
130	6638	6639	6640	6641	6642	6643	6644	6645	6646	6647	6648	6649
131	6650	6651	6652	6653	6654	6655	6656	6657	6658	6659	6660	6661
132	6662	6663	6664	6665	6666	6667	6668	6669	6670	6671	6672	6673
133	6674	6675	6676	6677	6678	6679	6680	6681	6682	6683	6684	6685
134	6686	6687	6688	6689	6690	6691	6692	6693	6694	6695	6696	6697
135	6698	6699	6700	6701	6702	6703	6704	6705	6706	6707	6708	6709
136	6710	6711	6712	6713	6714	6715	6716	6717	6718	6719	6720	6721
137	6722	6723	6724	6725	6726	6727	6728	6729	6730	6731	6732	6733
138	6734	6735	6736	6737	6738	6739	6740	6741	6742	6743	6744	6745
139	6746	6747	6748	6749	6750	6751	6752	6753	6754	6755	6756	6757
140	6758	6759	6760	6761	6762	6763	6764	6765	6766	6767	6768	6769
141	6770	6771	6772	6773	6774	6775	6776	6777	6778	6779	6780	6781
142	6782	6783	6784	6785	6786	6787	6788	6789	6790	6791	6792	6793
143	6794	6795	6796	6797	6798	6799	6800	6801	6802	6803	6804	6805
144	6806	6807	6808	6809	6810	6811	6812	6813	6814	6815	6816	6817
145	6818	6819	6820	6821	6822	6823	6824	6825	6826	6827	6828	6829

Chapter 10 Internal Memory Address of “Read/Write Variable Data” command

Step	Target position		Cir. int. auxiliary point		Operation speed		Dwell time	M code	Sub. Axis setting	Helical int.	Circular int. turns	Control word
	Low	High	Low	High	Low	High						
146	6830	6831	6832	6833	6834	6835	6836	6837	6838	6839	6840	6841
147	6842	6843	6844	6845	6846	6847	6848	6849	6850	6851	6852	6853
148	6854	6855	6856	6857	6858	6859	6860	6861	6862	6863	6864	6865
149	6866	6867	6868	6869	6870	6871	6872	6873	6874	6875	6876	6877
150	6878	6879	6880	6881	6882	6883	6884	6885	6886	6887	6888	6889
151	6890	6891	6892	6893	6894	6895	6896	6897	6898	6899	6900	6901
152	6902	6903	6904	6905	6906	6907	6908	6909	6910	6911	6912	6913
153	6914	6915	6916	6917	6918	6919	6920	6921	6922	6923	6924	6925
154	6926	6927	6928	6929	6930	6931	6932	6933	6934	6935	6936	6937
155	6938	6939	6940	6941	6942	6943	6944	6945	6946	6947	6948	6949
156	6950	6951	6952	6953	6954	6955	6956	6957	6958	6959	6960	6961
157	6962	6963	6964	6965	6966	6967	6968	6969	6970	6971	6972	6973
158	6974	6975	6976	6977	6978	6979	6980	6981	6982	6983	6984	6985
159	6986	6987	6988	6989	6990	6991	6992	6993	6994	6995	6996	6997
160	6998	6999	7000	7001	7002	7003	7004	7005	7006	7007	7008	7009
161	7010	7011	7012	7013	7014	7015	7016	7017	7018	7019	7020	7021
162	7022	7023	7024	7025	7026	7027	7028	7029	7030	7031	7032	7033
163	7034	7035	7036	7037	7038	7039	7040	7041	7042	7043	7044	7045
164	7046	7047	7048	7049	7050	7051	7052	7053	7054	7055	7056	7057
165	7058	7059	7060	7061	7062	7063	7064	7065	7066	7067	7068	7069
166	7070	7071	7072	7073	7074	7075	7076	7077	7078	7079	7080	7081
167	7082	7083	7084	7085	7086	7087	7088	7089	7090	7091	7092	7093
168	7094	7095	7096	7097	7098	7099	7100	7101	7102	7103	7104	7105
169	7106	7107	7108	7109	7110	7111	7112	7113	7114	7115	7116	7117
170	7118	7119	7120	7121	7122	7123	7124	7125	7126	7127	7128	7129
171	7130	7131	7132	7133	7134	7135	7136	7137	7138	7139	7140	7141
172	7142	7143	7144	7145	7146	7147	7148	7149	7150	7151	7152	7153
173	7154	7155	7156	7157	7158	7159	7160	7161	7162	7163	7164	7165
174	7166	7167	7168	7169	7170	7171	7172	7173	7174	7175	7176	7177
175	7178	7179	7180	7181	7182	7183	7184	7185	7186	7187	7188	7189
176	7190	7191	7192	7193	7194	7195	7196	7197	7198	7199	7200	7201
177	7202	7203	7204	7205	7206	7207	7208	7209	7210	7211	7212	7213
178	7214	7215	7216	7217	7218	7219	7220	7221	7222	7223	7224	7225
179	7226	7227	7228	7229	7230	7231	7232	7233	7234	7235	7236	7237
180	7238	7239	7240	7241	7242	7243	7244	7245	7246	7247	7248	7249
181	7250	7251	7252	7253	7254	7255	7256	7257	7258	7259	7260	7261
182	7262	7263	7264	7265	7266	7267	7268	7269	7270	7271	7272	7273
183	7274	7275	7276	7277	7278	7279	7280	7281	7282	7283	7284	7285
184	7286	7287	7288	7289	7290	7291	7292	7293	7294	7295	7296	7297
185	7298	7299	7300	7301	7302	7303	7304	7305	7306	7307	7308	7309
186	7310	7311	7312	7313	7314	7315	7316	7317	7318	7319	7320	7321
187	7322	7323	7324	7325	7326	7327	7328	7329	7330	7331	7332	7333
188	7334	7335	7336	7337	7338	7339	7340	7341	7342	7343	7344	7345
189	7346	7347	7348	7349	7350	7351	7352	7353	7354	7355	7356	7357
190	7358	7359	7360	7361	7362	7363	7364	7365	7366	7367	7368	7369
191	7370	7371	7372	7373	7374	7375	7376	7377	7378	7379	7380	7381
192	7382	7383	7384	7385	7386	7387	7388	7389	7390	7391	7392	7393
193	7394	7395	7396	7397	7398	7399	7400	7401	7402	7403	7404	7405
194	7406	7407	7408	7409	7410	7411	7412	7413	7414	7415	7416	7417

Chapter 10 Internal Memory Address of “Read/Write Variable Data” command

Step	Target position		Cir. int. auxiliary point		Operation speed		Dwell time	M code	Sub. Axis setting	Helical int.	Circular int. turns	Control word
	Low	High	Low	High	Low	High						
195	7418	7419	7420	7421	7422	7423	7424	7425	7426	7427	7428	7429
196	7430	7431	7432	7433	7434	7435	7436	7437	7438	7439	7440	7441
197	7442	7443	7444	7445	7446	7447	7448	7449	7450	7451	7452	7453
198	7454	7455	7456	7457	7458	7459	7460	7461	7462	7463	7464	7465
199	7466	7467	7468	7469	7470	7471	7472	7473	7474	7475	7476	7477
200	7478	7479	7480	7481	7482	7483	7484	7485	7486	7487	7488	7489
201	7490	7491	7492	7493	7494	7495	7496	7497	7498	7499	7500	7501
202	7502	7503	7504	7505	7506	7507	7508	7509	7510	7511	7512	7513
203	7514	7515	7516	7517	7518	7519	7520	7521	7522	7523	7524	7525
204	7526	7527	7528	7529	7530	7531	7532	7533	7534	7535	7536	7537
205	7538	7539	7540	7541	7542	7543	7544	7545	7546	7547	7548	7549
206	7550	7551	7552	7553	7554	7555	7556	7557	7558	7559	7560	7561
207	7562	7563	7564	7565	7566	7567	7568	7569	7570	7571	7572	7573
208	7574	7575	7576	7577	7578	7579	7580	7581	7582	7583	7584	7585
209	7586	7587	7588	7589	7590	7591	7592	7593	7594	7595	7596	7597
210	7598	7599	7600	7601	7602	7603	7604	7605	7606	7607	7608	7609
211	7610	7611	7612	7613	7614	7615	7616	7617	7618	7619	7620	7621
212	7622	7623	7624	7625	7626	7627	7628	7629	7630	7631	7632	7633
213	7634	7635	7636	7637	7638	7639	7640	7641	7642	7643	7644	7645
214	7646	7647	7648	7649	7650	7651	7652	7653	7654	7655	7656	7657
215	7658	7659	7660	7661	7662	7663	7664	7665	7666	7667	7668	7669
216	7670	7671	7672	7673	7674	7675	7676	7677	7678	7679	7680	7681
217	7682	7683	7684	7685	7686	7687	7688	7689	7690	7691	7692	7693
218	7694	7695	7696	7697	7698	7699	7700	7701	7702	7703	7704	7705
219	7706	7707	7708	7709	7710	7711	7712	7713	7714	7715	7716	7717
220	7718	7719	7720	7721	7722	7723	7724	7725	7726	7727	7728	7729
221	7730	7731	7732	7733	7734	7735	7736	7737	7738	7739	7740	7741
222	7742	7743	7744	7745	7746	7747	7748	7749	7750	7751	7752	7753
223	7754	7755	7756	7757	7758	7759	7760	7761	7762	7763	7764	7765
224	7766	7767	7768	7769	7770	7771	7772	7773	7774	7775	7776	7777
225	7778	7779	7780	7781	7782	7783	7784	7785	7786	7787	7788	7789
226	7790	7791	7792	7793	7794	7795	7796	7797	7798	7799	7800	7801
227	7802	7803	7804	7805	7806	7807	7808	7809	7810	7811	7812	7813
228	7814	7815	7816	7817	7818	7819	7820	7821	7822	7823	7824	7825
229	7826	7827	7828	7829	7830	7831	7832	7833	7834	7835	7836	7837
230	7838	7839	7840	7841	7842	7843	7844	7845	7846	7847	7848	7849
231	7850	7851	7852	7853	7854	7855	7856	7857	7858	7859	7860	7861
232	7862	7863	7864	7865	7866	7867	7868	7869	7870	7871	7872	7873
233	7874	7875	7876	7877	7878	7879	7880	7881	7882	7883	7884	7885
234	7886	7887	7888	7889	7890	7891	7892	7893	7894	7895	7896	7897
235	7898	7899	7900	7901	7902	7903	7904	7905	7906	7907	7908	7909
236	7910	7911	7912	7913	7914	7915	7916	7917	7918	7919	7920	7921
237	7922	7923	7924	7925	7926	7927	7928	7929	7930	7931	7932	7933
238	7934	7935	7936	7937	7938	7939	7940	7941	7942	7943	7944	7945
239	7946	7947	7948	7949	7950	7951	7952	7953	7954	7955	7956	7957
240	7958	7959	7960	7961	7962	7963	7964	7965	7966	7967	7968	7969
241	7970	7971	7972	7973	7974	7975	7976	7977	7978	7979	7980	7981
242	7982	7983	7984	7985	7986	7987	7988	7989	7990	7991	7992	7993
243	7994	7995	7996	7997	7998	7999	8000	8001	8002	8003	8004	8005

Chapter 10 Internal Memory Address of “Read/Write Variable Data” command

Step	Target position		Cir. int. auxiliary point		Operation speed		Dwell time	M code	Sub. Axis setting	Helical int.	Circular int. turns	Control word
	Low	High	Low	High	Low	High						
244	8006	8007	8008	8009	8010	8011	8012	8013	8014	8015	8016	8017
245	8018	8019	8020	8021	8022	8023	8024	8025	8026	8027	8028	8029
246	8030	8031	8032	8033	8034	8035	8036	8037	8038	8039	8040	8041
247	8042	8043	8044	8045	8046	8047	8048	8049	8050	8051	8052	8053
248	8054	8055	8056	8057	8058	8059	8060	8061	8062	8063	8064	8065
249	8066	8067	8068	8069	8070	8071	8072	8073	8074	8075	8076	8077
250	8078	8079	8080	8081	8082	8083	8084	8085	8086	8087	8088	8089
251	8090	8091	8092	8093	8094	8095	8096	8097	8098	8099	8100	8101
252	8102	8103	8104	8105	8106	8107	8108	8109	8110	8111	8112	8113
253	8114	8115	8116	8117	8118	8119	8120	8121	8122	8123	8124	8125
254	8126	8127	8128	8129	8130	8131	8132	8133	8134	8135	8136	8137
255	8138	8139	8140	8141	8142	8143	8144	8145	8146	8147	8148	8149
256	8150	8151	8152	8153	8154	8155	8156	8157	8158	8159	8160	8161
257	8162	8163	8164	8165	8166	8167	8168	8169	8170	8171	8172	8173
258	8174	8175	8176	8177	8178	8179	8180	8181	8182	8183	8184	8185
259	8186	8187	8188	8189	8190	8191	8192	8193	8194	8195	8196	8197
260	8198	8199	8200	8201	8202	8203	8204	8205	8206	8207	8208	8209
261	8210	8211	8212	8213	8214	8215	8216	8217	8218	8219	8220	8221
262	8222	8223	8224	8225	8226	8227	8228	8229	8230	8231	8232	8233
263	8234	8235	8236	8237	8238	8239	8240	8241	8242	8243	8244	8245
264	8246	8247	8248	8249	8250	8251	8252	8253	8254	8255	8256	8257
265	8258	8259	8260	8261	8262	8263	8264	8265	8266	8267	8268	8269
266	8270	8271	8272	8273	8274	8275	8276	8277	8278	8279	8280	8281
267	8282	8283	8284	8285	8286	8287	8288	8289	8290	8291	8292	8293
268	8294	8295	8296	8297	8298	8299	8300	8301	8302	8303	8304	8305
269	8306	8307	8308	8309	8310	8311	8312	8313	8314	8315	8316	8317
270	8318	8319	8320	8321	8322	8323	8324	8325	8326	8327	8328	8329
271	8330	8331	8332	8333	8334	8335	8336	8337	8338	8339	8340	8341
272	8342	8343	8344	8345	8346	8347	8348	8349	8350	8351	8352	8353
273	8354	8355	8356	8357	8358	8359	8360	8361	8362	8363	8364	8365
274	8366	8367	8368	8369	8370	8371	8372	8373	8374	8375	8376	8377
275	8378	8379	8380	8381	8382	8383	8384	8385	8386	8387	8388	8389
276	8390	8391	8392	8393	8394	8395	8396	8397	8398	8399	8400	8401
277	8402	8403	8404	8405	8406	8407	8408	8409	8410	8411	8412	8413
278	8414	8415	8416	8417	8418	8419	8420	8421	8422	8423	8424	8425
279	8426	8427	8428	8429	8430	8431	8432	8433	8434	8435	8436	8437
280	8438	8439	8440	8441	8442	8443	8444	8445	8446	8447	8448	8449
281	8450	8451	8452	8453	8454	8455	8456	8457	8458	8459	8460	8461
282	8462	8463	8464	8465	8466	8467	8468	8469	8470	8471	8472	8473
283	8474	8475	8476	8477	8478	8479	8480	8481	8482	8483	8484	8485
284	8486	8487	8488	8489	8490	8491	8492	8493	8494	8495	8496	8497
285	8498	8499	8500	8501	8502	8503	8504	8505	8506	8507	8508	8509
286	8510	8511	8512	8513	8514	8515	8516	8517	8518	8519	8520	8521
287	8522	8523	8524	8525	8526	8527	8528	8529	8530	8531	8532	8533
288	8534	8535	8536	8537	8538	8539	8540	8541	8542	8543	8544	8545
289	8546	8547	8548	8549	8550	8551	8552	8553	8554	8555	8556	8557
290	8558	8559	8560	8561	8562	8563	8564	8565	8566	8567	8568	8569
291	8570	8571	8572	8573	8574	8575	8576	8577	8578	8579	8580	8581
292	8582	8583	8584	8585	8586	8587	8588	8589	8590	8591	8592	8593

Chapter 10 Internal Memory Address of “Read/Write Variable Data” command

Step	Target position		Cir. int. auxiliary point		Operation speed		Dwell time	M code	Sub. Axis setting	Helical int.	Circular int. turns	Control word
	Low	High	Low	High	Low	High						
293	8594	8595	8596	8597	8598	8599	8600	8601	8602	8603	8604	8605
294	8606	8607	8608	8609	8610	8611	8612	8613	8614	8615	8616	8617
295	8618	8619	8620	8621	8622	8623	8624	8625	8626	8627	8628	8629
296	8630	8631	8632	8633	8634	8635	8636	8637	8638	8639	8640	8641
297	8642	8643	8644	8645	8646	8647	8648	8649	8650	8651	8652	8653
298	8654	8655	8656	8657	8658	8659	8660	8661	8662	8663	8664	8665
299	8666	8667	8668	8669	8670	8671	8672	8673	8674	8675	8676	8677
300	8678	8679	8680	8681	8682	8683	8684	8685	8686	8687	8688	8689
301	8690	8691	8692	8693	8694	8695	8696	8697	8698	8699	8700	8701
302	8702	8703	8704	8705	8706	8707	8708	8709	8710	8711	8712	8713
303	8714	8715	8716	8717	8718	8719	8720	8721	8722	8723	8724	8725
304	8726	8727	8728	8729	8730	8731	8732	8733	8734	8735	8736	8737
305	8738	8739	8740	8741	8742	8743	8744	8745	8746	8747	8748	8749
306	8750	8751	8752	8753	8754	8755	8756	8757	8758	8759	8760	8761
307	8762	8763	8764	8765	8766	8767	8768	8769	8770	8771	8772	8773
308	8774	8775	8776	8777	8778	8779	8780	8781	8782	8783	8784	8785
309	8786	8787	8788	8789	8790	8791	8792	8793	8794	8795	8796	8797
310	8798	8799	8800	8801	8802	8803	8804	8805	8806	8807	8808	8809
311	8810	8811	8812	8813	8814	8815	8816	8817	8818	8819	8820	8821
312	8822	8823	8824	8825	8826	8827	8828	8829	8830	8831	8832	8833
313	8834	8835	8836	8837	8838	8839	8840	8841	8842	8843	8844	8845
314	8846	8847	8848	8849	8850	8851	8852	8853	8854	8855	8856	8857
315	8858	8859	8860	8861	8862	8863	8864	8865	8866	8867	8868	8869
316	8870	8871	8872	8873	8874	8875	8876	8877	8878	8879	8880	8881
317	8882	8883	8884	8885	8886	8887	8888	8889	8890	8891	8892	8893
318	8894	8895	8896	8897	8898	8899	8900	8901	8902	8903	8904	8905
319	8906	8907	8908	8909	8910	8911	8912	8913	8914	8915	8916	8917
320	8918	8919	8920	8921	8922	8923	8924	8925	8926	8927	8928	8929
321	8930	8931	8932	8933	8934	8935	8936	8937	8938	8939	8940	8941
322	8942	8943	8944	8945	8946	8947	8948	8949	8950	8951	8952	8953
323	8954	8955	8956	8957	8958	8959	8960	8961	8962	8963	8964	8965
324	8966	8967	8968	8969	8970	8971	8972	8973	8974	8975	8976	8977
325	8978	8979	8980	8981	8982	8983	8984	8985	8986	8987	8988	8989
326	8990	8991	8992	8993	8994	8995	8996	8997	8998	8999	9000	9001
327	9002	9003	9004	9005	9006	9007	9008	9009	9010	9011	9012	9013
328	9014	9015	9016	9017	9018	9019	9020	9021	9022	9023	9024	9025
329	9026	9027	9028	9029	9030	9031	9032	9033	9034	9035	9036	9037
330	9038	9039	9040	9041	9042	9043	9044	9045	9046	9047	9048	9049
331	9050	9051	9052	9053	9054	9055	9056	9057	9058	9059	9060	9061
332	9062	9063	9064	9065	9066	9067	9068	9069	9070	9071	9072	9073
333	9074	9075	9076	9077	9078	9079	9080	9081	9082	9083	9084	9085
334	9086	9087	9088	9089	9090	9091	9092	9093	9094	9095	9096	9097
335	9098	9099	9100	9101	9102	9103	9104	9105	9106	9107	9108	9109
336	9110	9111	9112	9113	9114	9115	9116	9117	9118	9119	9120	9121
337	9122	9123	9124	9125	9126	9127	9128	9129	9130	9131	9132	9133
338	9134	9135	9136	9137	9138	9139	9140	9141	9142	9143	9144	9145
339	9146	9147	9148	9149	9150	9151	9152	9153	9154	9155	9156	9157
340	9158	9159	9160	9161	9162	9163	9164	9165	9166	9167	9168	9169
341	9170	9171	9172	9173	9174	9175	9176	9177	9178	9179	9180	9181

Chapter 10 Internal Memory Address of “Read/Write Variable Data” command

Step	Target position		Cir. int. auxiliary point		Operation speed		Dwell time	M code	Sub. Axis setting	Helical int.	Circular int. turns	Control word
	Low	High	Low	High	Low	High						
342	9182	9183	9184	9185	9186	9187	9188	9189	9190	9191	9192	9193
343	9194	9195	9196	9197	9198	9199	9200	9201	9202	9203	9204	9205
344	9206	9207	9208	9209	9210	9211	9212	9213	9214	9215	9216	9217
345	9218	9219	9220	9221	9222	9223	9224	9225	9226	9227	9228	9229
346	9230	9231	9232	9233	9234	9235	9236	9237	9238	9239	9240	9241
347	9242	9243	9244	9245	9246	9247	9248	9249	9250	9251	9252	9253
348	9254	9255	9256	9257	9258	9259	9260	9261	9262	9263	9264	9265
349	9266	9267	9268	9269	9270	9271	9272	9273	9274	9275	9276	9277
350	9278	9279	9280	9281	9282	9283	9284	9285	9286	9287	9288	9289
351	9290	9291	9292	9293	9294	9295	9296	9297	9298	9299	9300	9301
352	9302	9303	9304	9305	9306	9307	9308	9309	9310	9311	9312	9313
353	9314	9315	9316	9317	9318	9319	9320	9321	9322	9323	9324	9325
354	9326	9327	9328	9329	9330	9331	9332	9333	9334	9335	9336	9337
355	9338	9339	9340	9341	9342	9343	9344	9345	9346	9347	9348	9349
356	9350	9351	9352	9353	9354	9355	9356	9357	9358	9359	9360	9361
357	9362	9363	9364	9365	9366	9367	9368	9369	9370	9371	9372	9373
358	9374	9375	9376	9377	9378	9379	9380	9381	9382	9383	9384	9385
359	9386	9387	9388	9389	9390	9391	9392	9393	9394	9395	9396	9397
360	9398	9399	9400	9401	9402	9403	9404	9405	9406	9407	9408	9409
361	9410	9411	9412	9413	9414	9415	9416	9417	9418	9419	9420	9421
362	9422	9423	9424	9425	9426	9427	9428	9429	9430	9431	9432	9433
363	9434	9435	9436	9437	9438	9439	9440	9441	9442	9443	9444	9445
364	9446	9447	9448	9449	9450	9451	9452	9453	9454	9455	9456	9457
365	9458	9459	9460	9461	9462	9463	9464	9465	9466	9467	9468	9469
366	9470	9471	9472	9473	9474	9475	9476	9477	9478	9479	9480	9481
367	9482	9483	9484	9485	9486	9487	9488	9489	9490	9491	9492	9493
368	9494	9495	9496	9497	9498	9499	9500	9501	9502	9503	9504	9505
369	9506	9507	9508	9509	9510	9511	9512	9513	9514	9515	9516	9517
370	9518	9519	9520	9521	9522	9523	9524	9525	9526	9527	9528	9529
371	9530	9531	9532	9533	9534	9535	9536	9537	9538	9539	9540	9541
372	9542	9543	9544	9545	9546	9547	9548	9549	9550	9551	9552	9553
373	9554	9555	9556	9557	9558	9559	9560	9561	9562	9563	9564	9565
374	9566	9567	9568	9569	9570	9571	9572	9573	9574	9575	9576	9577
375	9578	9579	9580	9581	9582	9583	9584	9585	9586	9587	9588	9589
376	9590	9591	9592	9593	9594	9595	9596	9597	9598	9599	9600	9601
377	9602	9603	9604	9605	9606	9607	9608	9609	9610	9611	9612	9613
378	9614	9615	9616	9617	9618	9619	9620	9621	9622	9623	9624	9625
379	9626	9627	9628	9629	9630	9631	9632	9633	9634	9635	9636	9637
380	9638	9639	9640	9641	9642	9643	9644	9645	9646	9647	9648	9649
381	9650	9651	9652	9653	9654	9655	9656	9657	9658	9659	9660	9661
382	9662	9663	9664	9665	9666	9667	9668	9669	9670	9671	9672	9673
383	9674	9675	9676	9677	9678	9679	9680	9681	9682	9683	9684	9685
384	9686	9687	9688	9689	9690	9691	9692	9693	9694	9695	9696	9697
385	9698	9699	9700	9701	9702	9703	9704	9705	9706	9707	9708	9709
386	9710	9711	9712	9713	9714	9715	9716	9717	9718	9719	9720	9721
387	9722	9723	9724	9725	9726	9727	9728	9729	9730	9731	9732	9733
388	9734	9735	9736	9737	9738	9739	9740	9741	9742	9743	9744	9745
389	9746	9747	9748	9749	9750	9751	9752	9753	9754	9755	9756	9757
390	9758	9759	9760	9761	9762	9763	9764	9765	9766	9767	9768	9769

Chapter 10 Internal Memory Address of “Read/Write Variable Data” command

Step	Target position		Cir. int. auxiliary point		Operation speed		Dwell time	M code	Sub. Axis setting	Helical int.	Circular int. turns	Control word
	Low	High	Low	High	Low	High						
391	9770	9771	9772	9773	9774	9775	9776	9777	9778	9779	9780	9781
392	9782	9783	9784	9785	9786	9787	9788	9789	9790	9791	9792	9793
393	9794	9795	9796	9797	9798	9799	9800	9801	9802	9803	9804	9805
394	9806	9807	9808	9809	9810	9811	9812	9813	9814	9815	9816	9817
395	9818	9819	9820	9821	9822	9823	9824	9825	9826	9827	9828	9829
396	9830	9831	9832	9833	9834	9835	9836	9837	9838	9839	9840	9841
397	9842	9843	9844	9845	9846	9847	9848	9849	9850	9851	9852	9853
398	9854	9855	9856	9857	9858	9859	9860	9861	9862	9863	9864	9865
399	9866	9867	9868	9869	9870	9871	9872	9873	9874	9875	9876	9877
400	9878	9879	9880	9881	9882	9883	9884	9885	9886	9887	9888	9889

Chapter 10 Internal Memory Address of “Read/Write Variable Data” command

10.4 Axis 3 operation data memory address

Step	Target position		Cir. int. auxiliary point		Operation speed		Dwell time	M code	Sub. Axis setting	Helical int.	Circular int. turns	Control word
	Low	High	Low	High	Low	High						
1	9890	9891	9892	9893	9894	9895	9896	9897	9898	9899	9900	9901
2	9902	9903	9904	9905	9906	9907	9908	9909	9910	9911	9912	9913
3	9914	9915	9916	9917	9918	9919	9920	9921	9922	9923	9924	9925
4	9926	9927	9928	9929	9930	9931	9932	9933	9934	9935	9936	9937
5	9938	9939	9940	9941	9942	9943	9944	9945	9946	9947	9948	9949
6	9950	9951	9952	9953	9954	9955	9956	9957	9958	9959	9960	9961
7	9962	9963	9964	9965	9966	9967	9968	9969	9970	9971	9972	9973
8	9974	9975	9976	9977	9978	9979	9980	9981	9982	9983	9984	9985
9	9986	9987	9988	9989	9990	9991	9992	9993	9994	9995	9996	9997
10	9998	9999	10000	10001	10002	10003	10004	10005	10006	10007	10008	10009
11	10010	10011	10012	10013	10014	10015	10016	10017	10018	10019	10020	10021
12	10022	10023	10024	10025	10026	10027	10028	10029	10030	10031	10032	10033
13	10034	10035	10036	10037	10038	10039	10040	10041	10042	10043	10044	10045
14	10046	10047	10048	10049	10050	10051	10052	10053	10054	10055	10056	10057
15	10058	10059	10060	10061	10062	10063	10064	10065	10066	10067	10068	10069
16	10070	10071	10072	10073	10074	10075	10076	10077	10078	10079	10080	10081
17	10082	10083	10084	10085	10086	10087	10088	10089	10090	10091	10092	10093
18	10094	10095	10096	10097	10098	10099	10100	10101	10102	10103	10104	10105
19	10106	10107	10108	10109	10110	10111	10112	10113	10114	10115	10116	10117
20	10118	10119	10120	10121	10122	10123	10124	10125	10126	10127	10128	10129
21	10130	10131	10132	10133	10134	10135	10136	10137	10138	10139	10140	10141
22	10142	10143	10144	10145	10146	10147	10148	10149	10150	10151	10152	10153
23	10154	10155	10156	10157	10158	10159	10160	10161	10162	10163	10164	10165
24	10166	10167	10168	10169	10170	10171	10172	10173	10174	10175	10176	10177
25	10178	10179	10180	10181	10182	10183	10184	10185	10186	10187	10188	10189
26	10190	10191	10192	10193	10194	10195	10196	10197	10198	10199	10200	10201
27	10202	10203	10204	10205	10206	10207	10208	10209	10210	10211	10212	10213
28	10214	10215	10216	10217	10218	10219	10220	10221	10222	10223	10224	10225
29	10226	10227	10228	10229	10230	10231	10232	10233	10234	10235	10236	10237
30	10238	10239	10240	10241	10242	10243	10244	10245	10246	10247	10248	10249
31	10250	10251	10252	10253	10254	10255	10256	10257	10258	10259	10260	10261
32	10262	10263	10264	10265	10266	10267	10268	10269	10270	10271	10272	10273
33	10274	10275	10276	10277	10278	10279	10280	10281	10282	10283	10284	10285
34	10286	10287	10288	10289	10290	10291	10292	10293	10294	10295	10296	10297
35	10298	10299	10300	10301	10302	10303	10304	10305	10306	10307	10308	10309
36	10310	10311	10312	10313	10314	10315	10316	10317	10318	10319	10320	10321
37	10322	10323	10324	10325	10326	10327	10328	10329	10330	10331	10332	10333
38	10334	10335	10336	10337	10338	10339	10340	10341	10342	10343	10344	10345
39	10346	10347	10348	10349	10350	10351	10352	10353	10354	10355	10356	10357
40	10358	10359	10360	10361	10362	10363	10364	10365	10366	10367	10368	10369
41	10370	10371	10372	10373	10374	10375	10376	10377	10378	10379	10380	10381
42	10382	10383	10384	10385	10386	10387	10388	10389	10390	10391	10392	10393
43	10394	10395	10396	10397	10398	10399	10400	10401	10402	10403	10404	10405
44	10406	10407	10408	10409	10410	10411	10412	10413	10414	10415	10416	10417
45	10418	10419	10420	10421	10422	10423	10424	10425	10426	10427	10428	10429
46	10430	10431	10432	10433	10434	10435	10436	10437	10438	10439	10440	10441
47	10442	10443	10444	10445	10446	10447	10448	10449	10450	10451	10452	10453
48	10454	10455	10456	10457	10458	10459	10460	10461	10462	10463	10464	10465

Chapter 10 Internal Memory Address of “Read/Write Variable Data” command

Step	Target position		Cir. int. auxiliary point		Operation speed		Dwell time	M code	Sub. Axis setting	Helical int.	Circular int. turns	Control word
	Low	High	Low	High	Low	High						
49	10466	10467	10468	10469	10470	10471	10472	10473	10474	10475	10476	10477
50	10478	10479	10480	10481	10482	10483	10484	10485	10486	10487	10488	10489
51	10490	10491	10492	10493	10494	10495	10496	10497	10498	10499	10500	10501
52	10502	10503	10504	10505	10506	10507	10508	10509	10510	10511	10512	10513
53	10514	10515	10516	10517	10518	10519	10520	10521	10522	10523	10524	10525
54	10526	10527	10528	10529	10530	10531	10532	10533	10534	10535	10536	10537
55	10538	10539	10540	10541	10542	10543	10544	10545	10546	10547	10548	10549
56	10550	10551	10552	10553	10554	10555	10556	10557	10558	10559	10560	10561
57	10562	10563	10564	10565	10566	10567	10568	10569	10570	10571	10572	10573
58	10574	10575	10576	10577	10578	10579	10580	10581	10582	10583	10584	10585
59	10586	10587	10588	10589	10590	10591	10592	10593	10594	10595	10596	10597
60	10598	10599	10600	10601	10602	10603	10604	10605	10606	10607	10608	10609
61	10610	10611	10612	10613	10614	10615	10616	10617	10618	10619	10620	10621
62	10622	10623	10624	10625	10626	10627	10628	10629	10630	10631	10632	10633
63	10634	10635	10636	10637	10638	10639	10640	10641	10642	10643	10644	10645
64	10646	10647	10648	10649	10650	10651	10652	10653	10654	10655	10656	10657
65	10658	10659	10660	10661	10662	10663	10664	10665	10666	10667	10668	10669
66	10670	10671	10672	10673	10674	10675	10676	10677	10678	10679	10680	10681
67	10682	10683	10684	10685	10686	10687	10688	10689	10690	10691	10692	10693
68	10694	10695	10696	10697	10698	10699	10700	10701	10702	10703	10704	10705
69	10706	10707	10708	10709	10710	10711	10712	10713	10714	10715	10716	10717
70	10718	10719	10720	10721	10722	10723	10724	10725	10726	10727	10728	10729
71	10730	10731	10732	10733	10734	10735	10736	10737	10738	10739	10740	10741
72	10742	10743	10744	10745	10746	10747	10748	10749	10750	10751	10752	10753
73	10754	10755	10756	10757	10758	10759	10760	10761	10762	10763	10764	10765
74	10766	10767	10768	10769	10770	10771	10772	10773	10774	10775	10776	10777
75	10778	10779	10780	10781	10782	10783	10784	10785	10786	10787	10788	10789
76	10790	10791	10792	10793	10794	10795	10796	10797	10798	10799	10800	10801
77	10802	10803	10804	10805	10806	10807	10808	10809	10810	10811	10812	10813
78	10814	10815	10816	10817	10818	10819	10820	10821	10822	10823	10824	10825
79	10826	10827	10828	10829	10830	10831	10832	10833	10834	10835	10836	10837
80	10838	10839	10840	10841	10842	10843	10844	10845	10846	10847	10848	10849
81	10850	10851	10852	10853	10854	10855	10856	10857	10858	10859	10860	10861
82	10862	10863	10864	10865	10866	10867	10868	10869	10870	10871	10872	10873
83	10874	10875	10876	10877	10878	10879	10880	10881	10882	10883	10884	10885
84	10886	10887	10888	10889	10890	10891	10892	10893	10894	10895	10896	10897
85	10898	10899	10900	10901	10902	10903	10904	10905	10906	10907	10908	10909
86	10910	10911	10912	10913	10914	10915	10916	10917	10918	10919	10920	10921
87	10922	10923	10924	10925	10926	10927	10928	10929	10930	10931	10932	10933
88	10934	10935	10936	10937	10938	10939	10940	10941	10942	10943	10944	10945
89	10946	10947	10948	10949	10950	10951	10952	10953	10954	10955	10956	10957
90	10958	10959	10960	10961	10962	10963	10964	10965	10966	10967	10968	10969
91	10970	10971	10972	10973	10974	10975	10976	10977	10978	10979	10980	10981
92	10982	10983	10984	10985	10986	10987	10988	10989	10990	10991	10992	10993
93	10994	10995	10996	10997	10998	10999	11000	11001	11002	11003	11004	11005
94	11006	11007	11008	11009	11010	11011	11012	11013	11014	11015	11016	11017
95	11018	11019	11020	11021	11022	11023	11024	11025	11026	11027	11028	11029
96	11030	11031	11032	11033	11034	11035	11036	11037	11038	11039	11040	11041
97	11042	11043	11044	11045	11046	11047	11048	11049	11050	11051	11052	11053

Chapter 10 Internal Memory Address of “Read/Write Variable Data” command

Step	Target position		Cir. int. auxiliary point		Operation speed		Dwell time	M code	Sub. Axis setting	Helical int.	Circular int. turns	Control word
	Low	High	Low	High	Low	High						
98	11054	11055	11056	11057	11058	11059	11060	11061	11062	11063	11064	11065
99	11066	11067	11068	11069	11070	11071	11072	11073	11074	11075	11076	11077
100	11078	11079	11080	11081	11082	11083	11084	11085	11086	11087	11088	11089
101	11090	11091	11092	11093	11094	11095	11096	11097	11098	11099	11100	11101
102	11102	11103	11104	11105	11106	11107	11108	11109	11110	11111	11112	11113
103	11114	11115	11116	11117	11118	11119	11120	11121	11122	11123	11124	11125
104	11126	11127	11128	11129	11130	11131	11132	11133	11134	11135	11136	11137
105	11138	11139	11140	11141	11142	11143	11144	11145	11146	11147	11148	11149
106	11150	11151	11152	11153	11154	11155	11156	11157	11158	11159	11160	11161
107	11162	11163	11164	11165	11166	11167	11168	11169	11170	11171	11172	11173
108	11174	11175	11176	11177	11178	11179	11180	11181	11182	11183	11184	11185
109	11186	11187	11188	11189	11190	11191	11192	11193	11194	11195	11196	11197
110	11198	11199	11200	11201	11202	11203	11204	11205	11206	11207	11208	11209
111	11210	11211	11212	11213	11214	11215	11216	11217	11218	11219	11220	11221
112	11222	11223	11224	11225	11226	11227	11228	11229	11230	11231	11232	11233
113	11234	11235	11236	11237	11238	11239	11240	11241	11242	11243	11244	11245
114	11246	11247	11248	11249	11250	11251	11252	11253	11254	11255	11256	11257
115	11258	11259	11260	11261	11262	11263	11264	11265	11266	11267	11268	11269
116	11270	11271	11272	11273	11274	11275	11276	11277	11278	11279	11280	11281
117	11282	11283	11284	11285	11286	11287	11288	11289	11290	11291	11292	11293
118	11294	11295	11296	11297	11298	11299	11300	11301	11302	11303	11304	11305
119	11306	11307	11308	11309	11310	11311	11312	11313	11314	11315	11316	11317
120	11318	11319	11320	11321	11322	11323	11324	11325	11326	11327	11328	11329
121	11330	11331	11332	11333	11334	11335	11336	11337	11338	11339	11340	11341
122	11342	11343	11344	11345	11346	11347	11348	11349	11350	11351	11352	11353
123	11354	11355	11356	11357	11358	11359	11360	11361	11362	11363	11364	11365
124	11366	11367	11368	11369	11370	11371	11372	11373	11374	11375	11376	11377
125	11378	11379	11380	11381	11382	11383	11384	11385	11386	11387	11388	11389
126	11390	11391	11392	11393	11394	11395	11396	11397	11398	11399	11400	11401
127	11402	11403	11404	11405	11406	11407	11408	11409	11410	11411	11412	11413
128	11414	11415	11416	11417	11418	11419	11420	11421	11422	11423	11424	11425
129	11426	11427	11428	11429	11430	11431	11432	11433	11434	11435	11436	11437
130	11438	11439	11440	11441	11442	11443	11444	11445	11446	11447	11448	11449
131	11450	11451	11452	11453	11454	11455	11456	11457	11458	11459	11460	11461
132	11462	11463	11464	11465	11466	11467	11468	11469	11470	11471	11472	11473
133	11474	11475	11476	11477	11478	11479	11480	11481	11482	11483	11484	11485
134	11486	11487	11488	11489	11490	11491	11492	11493	11494	11495	11496	11497
135	11498	11499	11500	11501	11502	11503	11504	11505	11506	11507	11508	11509
136	11510	11511	11512	11513	11514	11515	11516	11517	11518	11519	11520	11521
137	11522	11523	11524	11525	11526	11527	11528	11529	11530	11531	11532	11533
138	11534	11535	11536	11537	11538	11539	11540	11541	11542	11543	11544	11545
139	11546	11547	11548	11549	11550	11551	11552	11553	11554	11555	11556	11557
140	11558	11559	11560	11561	11562	11563	11564	11565	11566	11567	11568	11569
141	11570	11571	11572	11573	11574	11575	11576	11577	11578	11579	11580	11581
142	11582	11583	11584	11585	11586	11587	11588	11589	11590	11591	11592	11593
143	11594	11595	11596	11597	11598	11599	11600	11601	11602	11603	11604	11605
144	11606	11607	11608	11609	11610	11611	11612	11613	11614	11615	11616	11617
145	11618	11619	11620	11621	11622	11623	11624	11625	11626	11627	11628	11629
146	11630	11631	11632	11633	11634	11635	11636	11637	11638	11639	11640	11641

Chapter 10 Internal Memory Address of “Read/Write Variable Data” command

Step	Target position		Cir. int. auxiliary point		Operation speed		Dwell time	M code	Sub. Axis setting	Helical int.	Circular int. turns	Control word
	Low	High	Low	High	Low	High						
147	11642	11643	11644	11645	11646	11647	11648	11649	11650	11651	11652	11653
148	11654	11655	11656	11657	11658	11659	11660	11661	11662	11663	11664	11665
149	11666	11667	11668	11669	11670	11671	11672	11673	11674	11675	11676	11677
150	11678	11679	11680	11681	11682	11683	11684	11685	11686	11687	11688	11689
151	11690	11691	11692	11693	11694	11695	11696	11697	11698	11699	11700	11701
152	11702	11703	11704	11705	11706	11707	11708	11709	11710	11711	11712	11713
153	11714	11715	11716	11717	11718	11719	11720	11721	11722	11723	11724	11725
154	11726	11727	11728	11729	11730	11731	11732	11733	11734	11735	11736	11737
155	11738	11739	11740	11741	11742	11743	11744	11745	11746	11747	11748	11749
156	11750	11751	11752	11753	11754	11755	11756	11757	11758	11759	11760	11761
157	11762	11763	11764	11765	11766	11767	11768	11769	11770	11771	11772	11773
158	11774	11775	11776	11777	11778	11779	11780	11781	11782	11783	11784	11785
159	11786	11787	11788	11789	11790	11791	11792	11793	11794	11795	11796	11797
160	11798	11799	11800	11801	11802	11803	11804	11805	11806	11807	11808	11809
161	11810	11811	11812	11813	11814	11815	11816	11817	11818	11819	11820	11821
162	11822	11823	11824	11825	11826	11827	11828	11829	11830	11831	11832	11833
163	11834	11835	11836	11837	11838	11839	11840	11841	11842	11843	11844	11845
164	11846	11847	11848	11849	11850	11851	11852	11853	11854	11855	11856	11857
165	11858	11859	11860	11861	11862	11863	11864	11865	11866	11867	11868	11869
166	11870	11871	11872	11873	11874	11875	11876	11877	11878	11879	11880	11881
167	11882	11883	11884	11885	11886	11887	11888	11889	11890	11891	11892	11893
168	11894	11895	11896	11897	11898	11899	11900	11901	11902	11903	11904	11905
169	11906	11907	11908	11909	11910	11911	11912	11913	11914	11915	11916	11917
170	11918	11919	11920	11921	11922	11923	11924	11925	11926	11927	11928	11929
171	11930	11931	11932	11933	11934	11935	11936	11937	11938	11939	11940	11941
172	11942	11943	11944	11945	11946	11947	11948	11949	11950	11951	11952	11953
173	11954	11955	11956	11957	11958	11959	11960	11961	11962	11963	11964	11965
174	11966	11967	11968	11969	11970	11971	11972	11973	11974	11975	11976	11977
175	11978	11979	11980	11981	11982	11983	11984	11985	11986	11987	11988	11989
176	11990	11991	11992	11993	11994	11995	11996	11997	11998	11999	12000	12001
177	12002	12003	12004	12005	12006	12007	12008	12009	12010	12011	12012	12013
178	12014	12015	12016	12017	12018	12019	12020	12021	12022	12023	12024	12025
179	12026	12027	12028	12029	12030	12031	12032	12033	12034	12035	12036	12037
180	12038	12039	12040	12041	12042	12043	12044	12045	12046	12047	12048	12049
181	12050	12051	12052	12053	12054	12055	12056	12057	12058	12059	12060	12061
182	12062	12063	12064	12065	12066	12067	12068	12069	12070	12071	12072	12073
183	12074	12075	12076	12077	12078	12079	12080	12081	12082	12083	12084	12085
184	12086	12087	12088	12089	12090	12091	12092	12093	12094	12095	12096	12097
185	12098	12099	12100	12101	12102	12103	12104	12105	12106	12107	12108	12109
186	12110	12111	12112	12113	12114	12115	12116	12117	12118	12119	12120	12121
187	12122	12123	12124	12125	12126	12127	12128	12129	12130	12131	12132	12133
188	12134	12135	12136	12137	12138	12139	12140	12141	12142	12143	12144	12145
189	12146	12147	12148	12149	12150	12151	12152	12153	12154	12155	12156	12157
190	12158	12159	12160	12161	12162	12163	12164	12165	12166	12167	12168	12169
191	12170	12171	12172	12173	12174	12175	12176	12177	12178	12179	12180	12181
192	12182	12183	12184	12185	12186	12187	12188	12189	12190	12191	12192	12193
193	12194	12195	12196	12197	12198	12199	12200	12201	12202	12203	12204	12205
194	12206	12207	12208	12209	12210	12211	12212	12213	12214	12215	12216	12217
195	12218	12219	12220	12221	12222	12223	12224	12225	12226	12227	12228	12229

Chapter 10 Internal Memory Address of “Read/Write Variable Data” command

Step	Target position		Cir. int. auxiliary point		Operation speed		Dwell time	M code	Sub. Axis setting	Helical int.	Circular int. turns	Control word
	Low	High	Low	High	Low	High						
196	12230	12231	12232	12233	12234	12235	12236	12237	12238	12239	12240	12241
197	12242	12243	12244	12245	12246	12247	12248	12249	12250	12251	12252	12253
198	12254	12255	12256	12257	12258	12259	12260	12261	12262	12263	12264	12265
199	12266	12267	12268	12269	12270	12271	12272	12273	12274	12275	12276	12277
200	12278	12279	12280	12281	12282	12283	12284	12285	12286	12287	12288	12289
201	12290	12291	12292	12293	12294	12295	12296	12297	12298	12299	12300	12301
202	12302	12303	12304	12305	12306	12307	12308	12309	12310	12311	12312	12313
203	12314	12315	12316	12317	12318	12319	12320	12321	12322	12323	12324	12325
204	12326	12327	12328	12329	12330	12331	12332	12333	12334	12335	12336	12337
205	12338	12339	12340	12341	12342	12343	12344	12345	12346	12347	12348	12349
206	12350	12351	12352	12353	12354	12355	12356	12357	12358	12359	12360	12361
207	12362	12363	12364	12365	12366	12367	12368	12369	12370	12371	12372	12373
208	12374	12375	12376	12377	12378	12379	12380	12381	12382	12383	12384	12385
209	12386	12387	12388	12389	12390	12391	12392	12393	12394	12395	12396	12397
210	12398	12399	12400	12401	12402	12403	12404	12405	12406	12407	12408	12409
211	12410	12411	12412	12413	12414	12415	12416	12417	12418	12419	12420	12421
212	12422	12423	12424	12425	12426	12427	12428	12429	12430	12431	12432	12433
213	12434	12435	12436	12437	12438	12439	12440	12441	12442	12443	12444	12445
214	12446	12447	12448	12449	12450	12451	12452	12453	12454	12455	12456	12457
215	12458	12459	12460	12461	12462	12463	12464	12465	12466	12467	12468	12469
216	12470	12471	12472	12473	12474	12475	12476	12477	12478	12479	12480	12481
217	12482	12483	12484	12485	12486	12487	12488	12489	12490	12491	12492	12493
218	12494	12495	12496	12497	12498	12499	12500	12501	12502	12503	12504	12505
219	12506	12507	12508	12509	12510	12511	12512	12513	12514	12515	12516	12517
220	12518	12519	12520	12521	12522	12523	12524	12525	12526	12527	12528	12529
221	12530	12531	12532	12533	12534	12535	12536	12537	12538	12539	12540	12541
222	12542	12543	12544	12545	12546	12547	12548	12549	12550	12551	12552	12553
223	12554	12555	12556	12557	12558	12559	12560	12561	12562	12563	12564	12565
224	12566	12567	12568	12569	12570	12571	12572	12573	12574	12575	12576	12577
225	12578	12579	12580	12581	12582	12583	12584	12585	12586	12587	12588	12589
226	12590	12591	12592	12593	12594	12595	12596	12597	12598	12599	12600	12601
227	12602	12603	12604	12605	12606	12607	12608	12609	12610	12611	12612	12613
228	12614	12615	12616	12617	12618	12619	12620	12621	12622	12623	12624	12625
229	12626	12627	12628	12629	12630	12631	12632	12633	12634	12635	12636	12637
230	12638	12639	12640	12641	12642	12643	12644	12645	12646	12647	12648	12649
231	12650	12651	12652	12653	12654	12655	12656	12657	12658	12659	12660	12661
232	12662	12663	12664	12665	12666	12667	12668	12669	12670	12671	12672	12673
233	12674	12675	12676	12677	12678	12679	12680	12681	12682	12683	12684	12685
234	12686	12687	12688	12689	12690	12691	12692	12693	12694	12695	12696	12697
235	12698	12699	12700	12701	12702	12703	12704	12705	12706	12707	12708	12709
236	12710	12711	12712	12713	12714	12715	12716	12717	12718	12719	12720	12721
237	12722	12723	12724	12725	12726	12727	12728	12729	12730	12731	12732	12733
238	12734	12735	12736	12737	12738	12739	12740	12741	12742	12743	12744	12745
239	12746	12747	12748	12749	12750	12751	12752	12753	12754	12755	12756	12757
240	12758	12759	12760	12761	12762	12763	12764	12765	12766	12767	12768	12769
241	12770	12771	12772	12773	12774	12775	12776	12777	12778	12779	12780	12781
242	12782	12783	12784	12785	12786	12787	12788	12789	12790	12791	12792	12793
243	12794	12795	12796	12797	12798	12799	12800	12801	12802	12803	12804	12805
244	12806	12807	12808	12809	12810	12811	12812	12813	12814	12815	12816	12817

Chapter 10 Internal Memory Address of “Read/Write Variable Data” command

Step	Target position		Cir. int. auxiliary point		Operation speed		Dwell time	M code	Sub. Axis setting	Helical int.	Circular int. turns	Control word
	Low	High	Low	High	Low	High						
245	12818	12819	12820	12821	12822	12823	12824	12825	12826	12827	12828	12829
246	12830	12831	12832	12833	12834	12835	12836	12837	12838	12839	12840	12841
247	12842	12843	12844	12845	12846	12847	12848	12849	12850	12851	12852	12853
248	12854	12855	12856	12857	12858	12859	12860	12861	12862	12863	12864	12865
249	12866	12867	12868	12869	12870	12871	12872	12873	12874	12875	12876	12877
250	12878	12879	12880	12881	12882	12883	12884	12885	12886	12887	12888	12889
251	12890	12891	12892	12893	12894	12895	12896	12897	12898	12899	12900	12901
252	12902	12903	12904	12905	12906	12907	12908	12909	12910	12911	12912	12913
253	12914	12915	12916	12917	12918	12919	12920	12921	12922	12923	12924	12925
254	12926	12927	12928	12929	12930	12931	12932	12933	12934	12935	12936	12937
255	12938	12939	12940	12941	12942	12943	12944	12945	12946	12947	12948	12949
256	12950	12951	12952	12953	12954	12955	12956	12957	12958	12959	12960	12961
257	12962	12963	12964	12965	12966	12967	12968	12969	12970	12971	12972	12973
258	12974	12975	12976	12977	12978	12979	12980	12981	12982	12983	12984	12985
259	12986	12987	12988	12989	12990	12991	12992	12993	12994	12995	12996	12997
260	12998	12999	13000	13001	13002	13003	13004	13005	13006	13007	13008	13009
261	13010	13011	13012	13013	13014	13015	13016	13017	13018	13019	13020	13021
262	13022	13023	13024	13025	13026	13027	13028	13029	13030	13031	13032	13033
263	13034	13035	13036	13037	13038	13039	13040	13041	13042	13043	13044	13045
264	13046	13047	13048	13049	13050	13051	13052	13053	13054	13055	13056	13057
265	13058	13059	13060	13061	13062	13063	13064	13065	13066	13067	13068	13069
266	13070	13071	13072	13073	13074	13075	13076	13077	13078	13079	13080	13081
267	13082	13083	13084	13085	13086	13087	13088	13089	13090	13091	13092	13093
268	13094	13095	13096	13097	13098	13099	13100	13101	13102	13103	13104	13105
269	13106	13107	13108	13109	13110	13111	13112	13113	13114	13115	13116	13117
270	13118	13119	13120	13121	13122	13123	13124	13125	13126	13127	13128	13129
271	13130	13131	13132	13133	13134	13135	13136	13137	13138	13139	13140	13141
272	13142	13143	13144	13145	13146	13147	13148	13149	13150	13151	13152	13153
273	13154	13155	13156	13157	13158	13159	13160	13161	13162	13163	13164	13165
274	13166	13167	13168	13169	13170	13171	13172	13173	13174	13175	13176	13177
275	13178	13179	13180	13181	13182	13183	13184	13185	13186	13187	13188	13189
276	13190	13191	13192	13193	13194	13195	13196	13197	13198	13199	13200	13201
277	13202	13203	13204	13205	13206	13207	13208	13209	13210	13211	13212	13213
278	13214	13215	13216	13217	13218	13219	13220	13221	13222	13223	13224	13225
279	13226	13227	13228	13229	13230	13231	13232	13233	13234	13235	13236	13237
280	13238	13239	13240	13241	13242	13243	13244	13245	13246	13247	13248	13249
281	13250	13251	13252	13253	13254	13255	13256	13257	13258	13259	13260	13261
282	13262	13263	13264	13265	13266	13267	13268	13269	13270	13271	13272	13273
283	13274	13275	13276	13277	13278	13279	13280	13281	13282	13283	13284	13285
284	13286	13287	13288	13289	13290	13291	13292	13293	13294	13295	13296	13297
285	13298	13299	13300	13301	13302	13303	13304	13305	13306	13307	13308	13309
286	13310	13311	13312	13313	13314	13315	13316	13317	13318	13319	13320	13321
287	13322	13323	13324	13325	13326	13327	13328	13329	13330	13331	13332	13333
288	13334	13335	13336	13337	13338	13339	13340	13341	13342	13343	13344	13345
289	13346	13347	13348	13349	13350	13351	13352	13353	13354	13355	13356	13357
290	13358	13359	13360	13361	13362	13363	13364	13365	13366	13367	13368	13369
291	13370	13371	13372	13373	13374	13375	13376	13377	13378	13379	13380	13381
292	13382	13383	13384	13385	13386	13387	13388	13389	13390	13391	13392	13393
293	13394	13395	13396	13397	13398	13399	13400	13401	13402	13403	13404	13405

Chapter 10 Internal Memory Address of “Read/Write Variable Data” command

Step	Target position		Cir. int. auxiliary point		Operation speed		Dwell time	M code	Sub. Axis setting	Helical int.	Circular int. turns	Control word
	Low	High	Low	High	Low	High						
294	13406	13407	13408	13409	13410	13411	13412	13413	13414	13415	13416	13417
295	13418	13419	13420	13421	13422	13423	13424	13425	13426	13427	13428	13429
296	13430	13431	13432	13433	13434	13435	13436	13437	13438	13439	13440	13441
297	13442	13443	13444	13445	13446	13447	13448	13449	13450	13451	13452	13453
298	13454	13455	13456	13457	13458	13459	13460	13461	13462	13463	13464	13465
299	13466	13467	13468	13469	13470	13471	13472	13473	13474	13475	13476	13477
300	13478	13479	13480	13481	13482	13483	13484	13485	13486	13487	13488	13489
301	13490	13491	13492	13493	13494	13495	13496	13497	13498	13499	13500	13501
302	13502	13503	13504	13505	13506	13507	13508	13509	13510	13511	13512	13513
303	13514	13515	13516	13517	13518	13519	13520	13521	13522	13523	13524	13525
304	13526	13527	13528	13529	13530	13531	13532	13533	13534	13535	13536	13537
305	13538	13539	13540	13541	13542	13543	13544	13545	13546	13547	13548	13549
306	13550	13551	13552	13553	13554	13555	13556	13557	13558	13559	13560	13561
307	13562	13563	13564	13565	13566	13567	13568	13569	13570	13571	13572	13573
308	13574	13575	13576	13577	13578	13579	13580	13581	13582	13583	13584	13585
309	13586	13587	13588	13589	13590	13591	13592	13593	13594	13595	13596	13597
310	13598	13599	13600	13601	13602	13603	13604	13605	13606	13607	13608	13609
311	13610	13611	13612	13613	13614	13615	13616	13617	13618	13619	13620	13621
312	13622	13623	13624	13625	13626	13627	13628	13629	13630	13631	13632	13633
313	13634	13635	13636	13637	13638	13639	13640	13641	13642	13643	13644	13645
314	13646	13647	13648	13649	13650	13651	13652	13653	13654	13655	13656	13657
315	13658	13659	13660	13661	13662	13663	13664	13665	13666	13667	13668	13669
316	13670	13671	13672	13673	13674	13675	13676	13677	13678	13679	13680	13681
317	13682	13683	13684	13685	13686	13687	13688	13689	13690	13691	13692	13693
318	13694	13695	13696	13697	13698	13699	13700	13701	13702	13703	13704	13705
319	13706	13707	13708	13709	13710	13711	13712	13713	13714	13715	13716	13717
320	13718	13719	13720	13721	13722	13723	13724	13725	13726	13727	13728	13729
321	13730	13731	13732	13733	13734	13735	13736	13737	13738	13739	13740	13741
322	13742	13743	13744	13745	13746	13747	13748	13749	13750	13751	13752	13753
323	13754	13755	13756	13757	13758	13759	13760	13761	13762	13763	13764	13765
324	13766	13767	13768	13769	13770	13771	13772	13773	13774	13775	13776	13777
325	13778	13779	13780	13781	13782	13783	13784	13785	13786	13787	13788	13789
326	13790	13791	13792	13793	13794	13795	13796	13797	13798	13799	13800	13801
327	13802	13803	13804	13805	13806	13807	13808	13809	13810	13811	13812	13813
328	13814	13815	13816	13817	13818	13819	13820	13821	13822	13823	13824	13825
329	13826	13827	13828	13829	13830	13831	13832	13833	13834	13835	13836	13837
330	13838	13839	13840	13841	13842	13843	13844	13845	13846	13847	13848	13849
331	13850	13851	13852	13853	13854	13855	13856	13857	13858	13859	13860	13861
332	13862	13863	13864	13865	13866	13867	13868	13869	13870	13871	13872	13873
333	13874	13875	13876	13877	13878	13879	13880	13881	13882	13883	13884	13885
334	13886	13887	13888	13889	13890	13891	13892	13893	13894	13895	13896	13897
335	13898	13899	13900	13901	13902	13903	13904	13905	13906	13907	13908	13909
336	13910	13911	13912	13913	13914	13915	13916	13917	13918	13919	13920	13921
337	13922	13923	13924	13925	13926	13927	13928	13929	13930	13931	13932	13933
338	13934	13935	13936	13937	13938	13939	13940	13941	13942	13943	13944	13945
339	13946	13947	13948	13949	13950	13951	13952	13953	13954	13955	13956	13957
340	13958	13959	13960	13961	13962	13963	13964	13965	13966	13967	13968	13969
341	13970	13971	13972	13973	13974	13975	13976	13977	13978	13979	13980	13981
342	13982	13983	13984	13985	13986	13987	13988	13989	13990	13991	13992	13993

Chapter 10 Internal Memory Address of “Read/Write Variable Data” command

Step	Target position		Cir. int. auxiliary point		Operation speed		Dwell time	M code	Sub. Axis setting	Helical int.	Circular int. turns	Control word
	Low	High	Low	High	Low	High						
343	13994	13995	13996	13997	13998	13999	14000	14001	14002	14003	14004	14005
344	14006	14007	14008	14009	14010	14011	14012	14013	14014	14015	14016	14017
345	14018	14019	14020	14021	14022	14023	14024	14025	14026	14027	14028	14029
346	14030	14031	14032	14033	14034	14035	14036	14037	14038	14039	14040	14041
347	14042	14043	14044	14045	14046	14047	14048	14049	14050	14051	14052	14053
348	14054	14055	14056	14057	14058	14059	14060	14061	14062	14063	14064	14065
349	14066	14067	14068	14069	14070	14071	14072	14073	14074	14075	14076	14077
350	14078	14079	14080	14081	14082	14083	14084	14085	14086	14087	14088	14089
351	14090	14091	14092	14093	14094	14095	14096	14097	14098	14099	14100	14101
352	14102	14103	14104	14105	14106	14107	14108	14109	14110	14111	14112	14113
353	14114	14115	14116	14117	14118	14119	14120	14121	14122	14123	14124	14125
354	14126	14127	14128	14129	14130	14131	14132	14133	14134	14135	14136	14137
355	14138	14139	14140	14141	14142	14143	14144	14145	14146	14147	14148	14149
356	14150	14151	14152	14153	14154	14155	14156	14157	14158	14159	14160	14161
357	14162	14163	14164	14165	14166	14167	14168	14169	14170	14171	14172	14173
358	14174	14175	14176	14177	14178	14179	14180	14181	14182	14183	14184	14185
359	14186	14187	14188	14189	14190	14191	14192	14193	14194	14195	14196	14197
360	14198	14199	14200	14201	14202	14203	14204	14205	14206	14207	14208	14209
361	14210	14211	14212	14213	14214	14215	14216	14217	14218	14219	14220	14221
362	14222	14223	14224	14225	14226	14227	14228	14229	14230	14231	14232	14233
363	14234	14235	14236	14237	14238	14239	14240	14241	14242	14243	14244	14245
364	14246	14247	14248	14249	14250	14251	14252	14253	14254	14255	14256	14257
365	14258	14259	14260	14261	14262	14263	14264	14265	14266	14267	14268	14269
366	14270	14271	14272	14273	14274	14275	14276	14277	14278	14279	14280	14281
367	14282	14283	14284	14285	14286	14287	14288	14289	14290	14291	14292	14293
368	14294	14295	14296	14297	14298	14299	14300	14301	14302	14303	14304	14305
369	14306	14307	14308	14309	14310	14311	14312	14313	14314	14315	14316	14317
370	14318	14319	14320	14321	14322	14323	14324	14325	14326	14327	14328	14329
371	14330	14331	14332	14333	14334	14335	14336	14337	14338	14339	14340	14341
372	14342	14343	14344	14345	14346	14347	14348	14349	14350	14351	14352	14353
373	14354	14355	14356	14357	14358	14359	14360	14361	14362	14363	14364	14365
374	14366	14367	14368	14369	14370	14371	14372	14373	14374	14375	14376	14377
375	14378	14379	14380	14381	14382	14383	14384	14385	14386	14387	14388	14389
376	14390	14391	14392	14393	14394	14395	14396	14397	14398	14399	14400	14401
377	14402	14403	14404	14405	14406	14407	14408	14409	14410	14411	14412	14413
378	14414	14415	14416	14417	14418	14419	14420	14421	14422	14423	14424	14425
379	14426	14427	14428	14429	14430	14431	14432	14433	14434	14435	14436	14437
380	14438	14439	14440	14441	14442	14443	14444	14445	14446	14447	14448	14449
381	14450	14451	14452	14453	14454	14455	14456	14457	14458	14459	14460	14461
382	14462	14463	14464	14465	14466	14467	14468	14469	14470	14471	14472	14473
383	14474	14475	14476	14477	14478	14479	14480	14481	14482	14483	14484	14485
384	14486	14487	14488	14489	14490	14491	14492	14493	14494	14495	14496	14497
385	14498	14499	14500	14501	14502	14503	14504	14505	14506	14507	14508	14509
386	14510	14511	14512	14513	14514	14515	14516	14517	14518	14519	14520	14521
387	14522	14523	14524	14525	14526	14527	14528	14529	14530	14531	14532	14533
388	14534	14535	14536	14537	14538	14539	14540	14541	14542	14543	14544	14545
389	14546	14547	14548	14549	14550	14551	14552	14553	14554	14555	14556	14557
390	14558	14559	14560	14561	14562	14563	14564	14565	14566	14567	14568	14569
391	14570	14571	14572	14573	14574	14575	14576	14577	14578	14579	14580	14581

Chapter 10 Internal Memory Address of “Read/Write Variable Data” command

Step	Target position		Cir. int. auxiliary point		Operation speed		Dwell time	M code	Sub. Axis setting	Helical int.	Circular int. turns	Control word
	Low	High	Low	High	Low	High						
392	14582	14583	14584	14585	14586	14587	14588	14589	14590	14591	14592	14593
393	14594	14595	14596	14597	14598	14599	14600	14601	14602	14603	14604	14605
394	14606	14607	14608	14609	14610	14611	14612	14613	14614	14615	14616	14617
395	14618	14619	14620	14621	14622	14623	14624	14625	14626	14627	14628	14629
396	14630	14631	14632	14633	14634	14635	14636	14637	14638	14639	14640	14641
397	14642	14643	14644	14645	14646	14647	14648	14649	14650	14651	14652	14653
398	14654	14655	14656	14657	14658	14659	14660	14661	14662	14663	14664	14665
399	14666	14667	14668	14669	14670	14671	14672	14673	14674	14675	14676	14677
400	14678	14679	14680	14681	14682	14683	14684	14685	14686	14687	14688	14689

Chapter 10 Internal Memory Address of “Read/Write Variable Data” command

10.5 Axis 4 operation data memory address

Step	Target position		Cir. int. auxiliary point		Operation speed		Dwell time	M code	Sub. Axis setting	Helical int.	Circular int. turns	Control word
	Low	High	Low	High	Low	High						
1	14690	14691	14692	14693	14694	14695	14696	14697	14698	14699	14700	14701
2	14702	14703	14704	14705	14706	14707	14708	14709	14710	14711	14712	14713
3	14714	14715	14716	14717	14718	14719	14720	14721	14722	14723	14724	14725
4	14726	14727	14728	14729	14730	14731	14732	14733	14734	14735	14736	14737
5	14738	14739	14740	14741	14742	14743	14744	14745	14746	14747	14748	14749
6	14750	14751	14752	14753	14754	14755	14756	14757	14758	14759	14760	14761
7	14762	14763	14764	14765	14766	14767	14768	14769	14770	14771	14772	14773
8	14774	14775	14776	14777	14778	14779	14780	14781	14782	14783	14784	14785
9	14786	14787	14788	14789	14790	14791	14792	14793	14794	14795	14796	14797
10	14798	14799	14800	14801	14802	14803	14804	14805	14806	14807	14808	14809
11	14810	14811	14812	14813	14814	14815	14816	14817	14818	14819	14820	14821
12	14822	14823	14824	14825	14826	14827	14828	14829	14830	14831	14832	14833
13	14834	14835	14836	14837	14838	14839	14840	14841	14842	14843	14844	14845
14	14846	14847	14848	14849	14850	14851	14852	14853	14854	14855	14856	14857
15	14858	14859	14860	14861	14862	14863	14864	14865	14866	14867	14868	14869
16	14870	14871	14872	14873	14874	14875	14876	14877	14878	14879	14880	14881
17	14882	14883	14884	14885	14886	14887	14888	14889	14890	14891	14892	14893
18	14894	14895	14896	14897	14898	14899	14900	14901	14902	14903	14904	14905
19	14906	14907	14908	14909	14910	14911	14912	14913	14914	14915	14916	14917
20	14918	14919	14920	14921	14922	14923	14924	14925	14926	14927	14928	14929
21	14930	14931	14932	14933	14934	14935	14936	14937	14938	14939	14940	14941
22	14942	14943	14944	14945	14946	14947	14948	14949	14950	14951	14952	14953
23	14954	14955	14956	14957	14958	14959	14960	14961	14962	14963	14964	14965
24	14966	14967	14968	14969	14970	14971	14972	14973	14974	14975	14976	14977
25	14978	14979	14980	14981	14982	14983	14984	14985	14986	14987	14988	14989
26	14990	14991	14992	14993	14994	14995	14996	14997	14998	14999	15000	15001
27	15002	15003	15004	15005	15006	15007	15008	15009	15010	15011	15012	15013
28	15014	15015	15016	15017	15018	15019	15020	15021	15022	15023	15024	15025
29	15026	15027	15028	15029	15030	15031	15032	15033	15034	15035	15036	15037
30	15038	15039	15040	15041	15042	15043	15044	15045	15046	15047	15048	15049
31	15050	15051	15052	15053	15054	15055	15056	15057	15058	15059	15060	15061
32	15062	15063	15064	15065	15066	15067	15068	15069	15070	15071	15072	15073
33	15074	15075	15076	15077	15078	15079	15080	15081	15082	15083	15084	15085
34	15086	15087	15088	15089	15090	15091	15092	15093	15094	15095	15096	15097
35	15098	15099	15100	15101	15102	15103	15104	15105	15106	15107	15108	15109
36	15110	15111	15112	15113	15114	15115	15116	15117	15118	15119	15120	15121
37	15122	15123	15124	15125	15126	15127	15128	15129	15130	15131	15132	15133
38	15134	15135	15136	15137	15138	15139	15140	15141	15142	15143	15144	15145
39	15146	15147	15148	15149	15150	15151	15152	15153	15154	15155	15156	15157
40	15158	15159	15160	15161	15162	15163	15164	15165	15166	15167	15168	15169
41	15170	15171	15172	15173	15174	15175	15176	15177	15178	15179	15180	15181
42	15182	15183	15184	15185	15186	15187	15188	15189	15190	15191	15192	15193
43	15194	15195	15196	15197	15198	15199	15200	15201	15202	15203	15204	15205
44	15206	15207	15208	15209	15210	15211	15212	15213	15214	15215	15216	15217
45	15218	15219	15220	15221	15222	15223	15224	15225	15226	15227	15228	15229
46	15230	15231	15232	15233	15234	15235	15236	15237	15238	15239	15240	15241
47	15242	15243	15244	15245	15246	15247	15248	15249	15250	15251	15252	15253

Chapter 10 Internal Memory Address of “Read/Write Variable Data” command

Step	Target position		Cir. int. auxiliary point		Operation speed		Dwell time	M code	Sub. Axis setting	Helical int.	Circular int. turns	Control word
	Low	High	Low	High	Low	High						
48	15254	15255	15256	15257	15258	15259	15260	15261	15262	15263	15264	15265
49	15266	15267	15268	15269	15270	15271	15272	15273	15274	15275	15276	15277
50	15278	15279	15280	15281	15282	15283	15284	15285	15286	15287	15288	15289
51	15290	15291	15292	15293	15294	15295	15296	15297	15298	15299	15300	15301
52	15302	15303	15304	15305	15306	15307	15308	15309	15310	15311	15312	15313
53	15314	15315	15316	15317	15318	15319	15320	15321	15322	15323	15324	15325
54	15326	15327	15328	15329	15330	15331	15332	15333	15334	15335	15336	15337
55	15338	15339	15340	15341	15342	15343	15344	15345	15346	15347	15348	15349
56	15350	15351	15352	15353	15354	15355	15356	15357	15358	15359	15360	15361
57	15362	15363	15364	15365	15366	15367	15368	15369	15370	15371	15372	15373
58	15374	15375	15376	15377	15378	15379	15380	15381	15382	15383	15384	15385
59	15386	15387	15388	15389	15390	15391	15392	15393	15394	15395	15396	15397
60	15398	15399	15400	15401	15402	15403	15404	15405	15406	15407	15408	15409
61	15410	15411	15412	15413	15414	15415	15416	15417	15418	15419	15420	15421
62	15422	15423	15424	15425	15426	15427	15428	15429	15430	15431	15432	15433
63	15434	15435	15436	15437	15438	15439	15440	15441	15442	15443	15444	15445
64	15446	15447	15448	15449	15450	15451	15452	15453	15454	15455	15456	15457
65	15458	15459	15460	15461	15462	15463	15464	15465	15466	15467	15468	15469
66	15470	15471	15472	15473	15474	15475	15476	15477	15478	15479	15480	15481
67	15482	15483	15484	15485	15486	15487	15488	15489	15490	15491	15492	15493
68	15494	15495	15496	15497	15498	15499	15500	15501	15502	15503	15504	15505
69	15506	15507	15508	15509	15510	15511	15512	15513	15514	15515	15516	15517
70	15518	15519	15520	15521	15522	15523	15524	15525	15526	15527	15528	15529
71	15530	15531	15532	15533	15534	15535	15536	15537	15538	15539	15540	15541
72	15542	15543	15544	15545	15546	15547	15548	15549	15550	15551	15552	15553
73	15554	15555	15556	15557	15558	15559	15560	15561	15562	15563	15564	15565
74	15566	15567	15568	15569	15570	15571	15572	15573	15574	15575	15576	15577
75	15578	15579	15580	15581	15582	15583	15584	15585	15586	15587	15588	15589
76	15590	15591	15592	15593	15594	15595	15596	15597	15598	15599	15600	15601
77	15602	15603	15604	15605	15606	15607	15608	15609	15610	15611	15612	15613
78	15614	15615	15616	15617	15618	15619	15620	15621	15622	15623	15624	15625
79	15626	15627	15628	15629	15630	15631	15632	15633	15634	15635	15636	15637
80	15638	15639	15640	15641	15642	15643	15644	15645	15646	15647	15648	15649
81	15650	15651	15652	15653	15654	15655	15656	15657	15658	15659	15660	15661
82	15662	15663	15664	15665	15666	15667	15668	15669	15670	15671	15672	15673
83	15674	15675	15676	15677	15678	15679	15680	15681	15682	15683	15684	15685
84	15686	15687	15688	15689	15690	15691	15692	15693	15694	15695	15696	15697
85	15698	15699	15700	15701	15702	15703	15704	15705	15706	15707	15708	15709
86	15710	15711	15712	15713	15714	15715	15716	15717	15718	15719	15720	15721
87	15722	15723	15724	15725	15726	15727	15728	15729	15730	15731	15732	15733
88	15734	15735	15736	15737	15738	15739	15740	15741	15742	15743	15744	15745
89	15746	15747	15748	15749	15750	15751	15752	15753	15754	15755	15756	15757
90	15758	15759	15760	15761	15762	15763	15764	15765	15766	15767	15768	15769
91	15770	15771	15772	15773	15774	15775	15776	15777	15778	15779	15780	15781
92	15782	15783	15784	15785	15786	15787	15788	15789	15790	15791	15792	15793
93	15794	15795	15796	15797	15798	15799	15800	15801	15802	15803	15804	15805
94	15806	15807	15808	15809	15810	15811	15812	15813	15814	15815	15816	15817
95	15818	15819	15820	15821	15822	15823	15824	15825	15826	15827	15828	15829
96	15830	15831	15832	15833	15834	15835	15836	15837	15838	15839	15840	15841

Chapter 10 Internal Memory Address of “Read/Write Variable Data” command

Step	Target position		Cir. int. auxiliary point		Operation speed		Dwell time	M code	Sub. Axis setting	Helical int.	Circular int. turns	Control word
	Low	High	Low	High	Low	High						
97	15842	15843	15844	15845	15846	15847	15848	15849	15850	15851	15852	15853
98	15854	15855	15856	15857	15858	15859	15860	15861	15862	15863	15864	15865
99	15866	15867	15868	15869	15870	15871	15872	15873	15874	15875	15876	15877
100	15878	15879	15880	15881	15882	15883	15884	15885	15886	15887	15888	15889
101	15890	15891	15892	15893	15894	15895	15896	15897	15898	15899	15900	15901
102	15902	15903	15904	15905	15906	15907	15908	15909	15910	15911	15912	15913
103	15914	15915	15916	15917	15918	15919	15920	15921	15922	15923	15924	15925
104	15926	15927	15928	15929	15930	15931	15932	15933	15934	15935	15936	15937
105	15938	15939	15940	15941	15942	15943	15944	15945	15946	15947	15948	15949
106	15950	15951	15952	15953	15954	15955	15956	15957	15958	15959	15960	15961
107	15962	15963	15964	15965	15966	15967	15968	15969	15970	15971	15972	15973
108	15974	15975	15976	15977	15978	15979	15980	15981	15982	15983	15984	15985
109	15986	15987	15988	15989	15990	15991	15992	15993	15994	15995	15996	15997
110	15998	15999	16000	16001	16002	16003	16004	16005	16006	16007	16008	16009
111	16010	16011	16012	16013	16014	16015	16016	16017	16018	16019	16020	16021
112	16022	16023	16024	16025	16026	16027	16028	16029	16030	16031	16032	16033
113	16034	16035	16036	16037	16038	16039	16040	16041	16042	16043	16044	16045
114	16046	16047	16048	16049	16050	16051	16052	16053	16054	16055	16056	16057
115	16058	16059	16060	16061	16062	16063	16064	16065	16066	16067	16068	16069
116	16070	16071	16072	16073	16074	16075	16076	16077	16078	16079	16080	16081
117	16082	16083	16084	16085	16086	16087	16088	16089	16090	16091	16092	16093
118	16094	16095	16096	16097	16098	16099	16100	16101	16102	16103	16104	16105
119	16106	16107	16108	16109	16110	16111	16112	16113	16114	16115	16116	16117
120	16118	16119	16120	16121	16122	16123	16124	16125	16126	16127	16128	16129
121	16130	16131	16132	16133	16134	16135	16136	16137	16138	16139	16140	16141
122	16142	16143	16144	16145	16146	16147	16148	16149	16150	16151	16152	16153
123	16154	16155	16156	16157	16158	16159	16160	16161	16162	16163	16164	16165
124	16166	16167	16168	16169	16170	16171	16172	16173	16174	16175	16176	16177
125	16178	16179	16180	16181	16182	16183	16184	16185	16186	16187	16188	16189
126	16190	16191	16192	16193	16194	16195	16196	16197	16198	16199	16200	16201
127	16202	16203	16204	16205	16206	16207	16208	16209	16210	16211	16212	16213
128	16214	16215	16216	16217	16218	16219	16220	16221	16222	16223	16224	16225
129	16226	16227	16228	16229	16230	16231	16232	16233	16234	16235	16236	16237
130	16238	16239	16240	16241	16242	16243	16244	16245	16246	16247	16248	16249
131	16250	16251	16252	16253	16254	16255	16256	16257	16258	16259	16260	16261
132	16262	16263	16264	16265	16266	16267	16268	16269	16270	16271	16272	16273
133	16274	16275	16276	16277	16278	16279	16280	16281	16282	16283	16284	16285
134	16286	16287	16288	16289	16290	16291	16292	16293	16294	16295	16296	16297
135	16298	16299	16300	16301	16302	16303	16304	16305	16306	16307	16308	16309
136	16310	16311	16312	16313	16314	16315	16316	16317	16318	16319	16320	16321
137	16322	16323	16324	16325	16326	16327	16328	16329	16330	16331	16332	16333
138	16334	16335	16336	16337	16338	16339	16340	16341	16342	16343	16344	16345
139	16346	16347	16348	16349	16350	16351	16352	16353	16354	16355	16356	16357
140	16358	16359	16360	16361	16362	16363	16364	16365	16366	16367	16368	16369
141	16370	16371	16372	16373	16374	16375	16376	16377	16378	16379	16380	16381
142	16382	16383	16384	16385	16386	16387	16388	16389	16390	16391	16392	16393
143	16394	16395	16396	16397	16398	16399	16400	16401	16402	16403	16404	16405
144	16406	16407	16408	16409	16410	16411	16412	16413	16414	16415	16416	16417
145	16418	16419	16420	16421	16422	16423	16424	16425	16426	16427	16428	16429

Chapter 10 Internal Memory Address of “Read/Write Variable Data” command

Step	Target position		Cir. int. auxiliary point		Operation speed		Dwell time	M code	Sub. Axis setting	Helical int.	Circular int. turns	Control word
	Low	High	Low	High	Low	High						
146	16430	16431	16432	16433	16434	16435	16436	16437	16438	16439	16440	16441
147	16442	16443	16444	16445	16446	16447	16448	16449	16450	16451	16452	16453
148	16454	16455	16456	16457	16458	16459	16460	16461	16462	16463	16464	16465
149	16466	16467	16468	16469	16470	16471	16472	16473	16474	16475	16476	16477
150	16478	16479	16480	16481	16482	16483	16484	16485	16486	16487	16488	16489
151	16490	16491	16492	16493	16494	16495	16496	16497	16498	16499	16500	16501
152	16502	16503	16504	16505	16506	16507	16508	16509	16510	16511	16512	16513
153	16514	16515	16516	16517	16518	16519	16520	16521	16522	16523	16524	16525
154	16526	16527	16528	16529	16530	16531	16532	16533	16534	16535	16536	16537
155	16538	16539	16540	16541	16542	16543	16544	16545	16546	16547	16548	16549
156	16550	16551	16552	16553	16554	16555	16556	16557	16558	16559	16560	16561
157	16562	16563	16564	16565	16566	16567	16568	16569	16570	16571	16572	16573
158	16574	16575	16576	16577	16578	16579	16580	16581	16582	16583	16584	16585
159	16586	16587	16588	16589	16590	16591	16592	16593	16594	16595	16596	16597
160	16598	16599	16600	16601	16602	16603	16604	16605	16606	16607	16608	16609
161	16610	16611	16612	16613	16614	16615	16616	16617	16618	16619	16620	16621
162	16622	16623	16624	16625	16626	16627	16628	16629	16630	16631	16632	16633
163	16634	16635	16636	16637	16638	16639	16640	16641	16642	16643	16644	16645
164	16646	16647	16648	16649	16650	16651	16652	16653	16654	16655	16656	16657
165	16658	16659	16660	16661	16662	16663	16664	16665	16666	16667	16668	16669
166	16670	16671	16672	16673	16674	16675	16676	16677	16678	16679	16680	16681
167	16682	16683	16684	16685	16686	16687	16688	16689	16690	16691	16692	16693
168	16694	16695	16696	16697	16698	16699	16700	16701	16702	16703	16704	16705
169	16706	16707	16708	16709	16710	16711	16712	16713	16714	16715	16716	16717
170	16718	16719	16720	16721	16722	16723	16724	16725	16726	16727	16728	16729
171	16730	16731	16732	16733	16734	16735	16736	16737	16738	16739	16740	16741
172	16742	16743	16744	16745	16746	16747	16748	16749	16750	16751	16752	16753
173	16754	16755	16756	16757	16758	16759	16760	16761	16762	16763	16764	16765
174	16766	16767	16768	16769	16770	16771	16772	16773	16774	16775	16776	16777
175	16778	16779	16780	16781	16782	16783	16784	16785	16786	16787	16788	16789
176	16790	16791	16792	16793	16794	16795	16796	16797	16798	16799	16800	16801
177	16802	16803	16804	16805	16806	16807	16808	16809	16810	16811	16812	16813
178	16814	16815	16816	16817	16818	16819	16820	16821	16822	16823	16824	16825
179	16826	16827	16828	16829	16830	16831	16832	16833	16834	16835	16836	16837
180	16838	16839	16840	16841	16842	16843	16844	16845	16846	16847	16848	16849
181	16850	16851	16852	16853	16854	16855	16856	16857	16858	16859	16860	16861
182	16862	16863	16864	16865	16866	16867	16868	16869	16870	16871	16872	16873
183	16874	16875	16876	16877	16878	16879	16880	16881	16882	16883	16884	16885
184	16886	16887	16888	16889	16890	16891	16892	16893	16894	16895	16896	16897
185	16898	16899	16900	16901	16902	16903	16904	16905	16906	16907	16908	16909
186	16910	16911	16912	16913	16914	16915	16916	16917	16918	16919	16920	16921
187	16922	16923	16924	16925	16926	16927	16928	16929	16930	16931	16932	16933
188	16934	16935	16936	16937	16938	16939	16940	16941	16942	16943	16944	16945
189	16946	16947	16948	16949	16950	16951	16952	16953	16954	16955	16956	16957
190	16958	16959	16960	16961	16962	16963	16964	16965	16966	16967	16968	16969
191	16970	16971	16972	16973	16974	16975	16976	16977	16978	16979	16980	16981
192	16982	16983	16984	16985	16986	16987	16988	16989	16990	16991	16992	16993
193	16994	16995	16996	16997	16998	16999	17000	17001	17002	17003	17004	17005
194	17006	17007	17008	17009	17010	17011	17012	17013	17014	17015	17016	17017

Chapter 10 Internal Memory Address of “Read/Write Variable Data” command

Step	Target position		Cir. int. auxiliary point		Operation speed		Dwell time	M code	Sub. Axis setting	Helical int.	Circular int. turns	Control word
	Low	High	Low	High	Low	High						
195	17018	17019	17020	17021	17022	17023	17024	17025	17026	17027	17028	17029
196	17030	17031	17032	17033	17034	17035	17036	17037	17038	17039	17040	17041
197	17042	17043	17044	17045	17046	17047	17048	17049	17050	17051	17052	17053
198	17054	17055	17056	17057	17058	17059	17060	17061	17062	17063	17064	17065
199	17066	17067	17068	17069	17070	17071	17072	17073	17074	17075	17076	17077
200	17078	17079	17080	17081	17082	17083	17084	17085	17086	17087	17088	17089
201	17090	17091	17092	17093	17094	17095	17096	17097	17098	17099	17100	17101
202	17102	17103	17104	17105	17106	17107	17108	17109	17110	17111	17112	17113
203	17114	17115	17116	17117	17118	17119	17120	17121	17122	17123	17124	17125
204	17126	17127	17128	17129	17130	17131	17132	17133	17134	17135	17136	17137
205	17138	17139	17140	17141	17142	17143	17144	17145	17146	17147	17148	17149
206	17150	17151	17152	17153	17154	17155	17156	17157	17158	17159	17160	17161
207	17162	17163	17164	17165	17166	17167	17168	17169	17170	17171	17172	17173
208	17174	17175	17176	17177	17178	17179	17180	17181	17182	17183	17184	17185
209	17186	17187	17188	17189	17190	17191	17192	17193	17194	17195	17196	17197
210	17198	17199	17200	17201	17202	17203	17204	17205	17206	17207	17208	17209
211	17210	17211	17212	17213	17214	17215	17216	17217	17218	17219	17220	17221
212	17222	17223	17224	17225	17226	17227	17228	17229	17230	17231	17232	17233
213	17234	17235	17236	17237	17238	17239	17240	17241	17242	17243	17244	17245
214	17246	17247	17248	17249	17250	17251	17252	17253	17254	17255	17256	17257
215	17258	17259	17260	17261	17262	17263	17264	17265	17266	17267	17268	17269
216	17270	17271	17272	17273	17274	17275	17276	17277	17278	17279	17280	17281
217	17282	17283	17284	17285	17286	17287	17288	17289	17290	17291	17292	17293
218	17294	17295	17296	17297	17298	17299	17300	17301	17302	17303	17304	17305
219	17306	17307	17308	17309	17310	17311	17312	17313	17314	17315	17316	17317
220	17318	17319	17320	17321	17322	17323	17324	17325	17326	17327	17328	17329
221	17330	17331	17332	17333	17334	17335	17336	17337	17338	17339	17340	17341
222	17342	17343	17344	17345	17346	17347	17348	17349	17350	17351	17352	17353
223	17354	17355	17356	17357	17358	17359	17360	17361	17362	17363	17364	17365
224	17366	17367	17368	17369	17370	17371	17372	17373	17374	17375	17376	17377
225	17378	17379	17380	17381	17382	17383	17384	17385	17386	17387	17388	17389
226	17390	17391	17392	17393	17394	17395	17396	17397	17398	17399	17400	17401
227	17402	17403	17404	17405	17406	17407	17408	17409	17410	17411	17412	17413
228	17414	17415	17416	17417	17418	17419	17420	17421	17422	17423	17424	17425
229	17426	17427	17428	17429	17430	17431	17432	17433	17434	17435	17436	17437
230	17438	17439	17440	17441	17442	17443	17444	17445	17446	17447	17448	17449
231	17450	17451	17452	17453	17454	17455	17456	17457	17458	17459	17460	17461
232	17462	17463	17464	17465	17466	17467	17468	17469	17470	17471	17472	17473
233	17474	17475	17476	17477	17478	17479	17480	17481	17482	17483	17484	17485
234	17486	17487	17488	17489	17490	17491	17492	17493	17494	17495	17496	17497
235	17498	17499	17500	17501	17502	17503	17504	17505	17506	17507	17508	17509
236	17510	17511	17512	17513	17514	17515	17516	17517	17518	17519	17520	17521
237	17522	17523	17524	17525	17526	17527	17528	17529	17530	17531	17532	17533
238	17534	17535	17536	17537	17538	17539	17540	17541	17542	17543	17544	17545
239	17546	17547	17548	17549	17550	17551	17552	17553	17554	17555	17556	17557
240	17558	17559	17560	17561	17562	17563	17564	17565	17566	17567	17568	17569
241	17570	17571	17572	17573	17574	17575	17576	17577	17578	17579	17580	17581
242	17582	17583	17584	17585	17586	17587	17588	17589	17590	17591	17592	17593
243	17594	17595	17596	17597	17598	17599	17600	17601	17602	17603	17604	17605

Chapter 10 Internal Memory Address of “Read/Write Variable Data” command

Step	Target position		Cir. int. auxiliary point		Operation speed		Dwell time	M code	Sub. Axis setting	Helical int.	Circular int. turns	Control word
	Low	High	Low	High	Low	High						
244	17606	17607	17608	17609	17610	17611	17612	17613	17614	17615	17616	17617
245	17618	17619	17620	17621	17622	17623	17624	17625	17626	17627	17628	17629
246	17630	17631	17632	17633	17634	17635	17636	17637	17638	17639	17640	17641
247	17642	17643	17644	17645	17646	17647	17648	17649	17650	17651	17652	17653
248	17654	17655	17656	17657	17658	17659	17660	17661	17662	17663	17664	17665
249	17666	17667	17668	17669	17670	17671	17672	17673	17674	17675	17676	17677
250	17678	17679	17680	17681	17682	17683	17684	17685	17686	17687	17688	17689
251	17690	17691	17692	17693	17694	17695	17696	17697	17698	17699	17700	17701
252	17702	17703	17704	17705	17706	17707	17708	17709	17710	17711	17712	17713
253	17714	17715	17716	17717	17718	17719	17720	17721	17722	17723	17724	17725
254	17726	17727	17728	17729	17730	17731	17732	17733	17734	17735	17736	17737
255	17738	17739	17740	17741	17742	17743	17744	17745	17746	17747	17748	17749
256	17750	17751	17752	17753	17754	17755	17756	17757	17758	17759	17760	17761
257	17762	17763	17764	17765	17766	17767	17768	17769	17770	17771	17772	17773
258	17774	17775	17776	17777	17778	17779	17780	17781	17782	17783	17784	17785
259	17786	17787	17788	17789	17790	17791	17792	17793	17794	17795	17796	17797
260	17798	17799	17800	17801	17802	17803	17804	17805	17806	17807	17808	17809
261	17810	17811	17812	17813	17814	17815	17816	17817	17818	17819	17820	17821
262	17822	17823	17824	17825	17826	17827	17828	17829	17830	17831	17832	17833
263	17834	17835	17836	17837	17838	17839	17840	17841	17842	17843	17844	17845
264	17846	17847	17848	17849	17850	17851	17852	17853	17854	17855	17856	17857
265	17858	17859	17860	17861	17862	17863	17864	17865	17866	17867	17868	17869
266	17870	17871	17872	17873	17874	17875	17876	17877	17878	17879	17880	17881
267	17882	17883	17884	17885	17886	17887	17888	17889	17890	17891	17892	17893
268	17894	17895	17896	17897	17898	17899	17900	17901	17902	17903	17904	17905
269	17906	17907	17908	17909	17910	17911	17912	17913	17914	17915	17916	17917
270	17918	17919	17920	17921	17922	17923	17924	17925	17926	17927	17928	17929
271	17930	17931	17932	17933	17934	17935	17936	17937	17938	17939	17940	17941
272	17942	17943	17944	17945	17946	17947	17948	17949	17950	17951	17952	17953
273	17954	17955	17956	17957	17958	17959	17960	17961	17962	17963	17964	17965
274	17966	17967	17968	17969	17970	17971	17972	17973	17974	17975	17976	17977
275	17978	17979	17980	17981	17982	17983	17984	17985	17986	17987	17988	17989
276	17990	17991	17992	17993	17994	17995	17996	17997	17998	17999	18000	18001
277	18002	18003	18004	18005	18006	18007	18008	18009	18010	18011	18012	18013
278	18014	18015	18016	18017	18018	18019	18020	18021	18022	18023	18024	18025
279	18026	18027	18028	18029	18030	18031	18032	18033	18034	18035	18036	18037
280	18038	18039	18040	18041	18042	18043	18044	18045	18046	18047	18048	18049
281	18050	18051	18052	18053	18054	18055	18056	18057	18058	18059	18060	18061
282	18062	18063	18064	18065	18066	18067	18068	18069	18070	18071	18072	18073
283	18074	18075	18076	18077	18078	18079	18080	18081	18082	18083	18084	18085
284	18086	18087	18088	18089	18090	18091	18092	18093	18094	18095	18096	18097
285	18098	18099	18100	18101	18102	18103	18104	18105	18106	18107	18108	18109
286	18110	18111	18112	18113	18114	18115	18116	18117	18118	18119	18120	18121
287	18122	18123	18124	18125	18126	18127	18128	18129	18130	18131	18132	18133
288	18134	18135	18136	18137	18138	18139	18140	18141	18142	18143	18144	18145
289	18146	18147	18148	18149	18150	18151	18152	18153	18154	18155	18156	18157
290	18158	18159	18160	18161	18162	18163	18164	18165	18166	18167	18168	18169
291	18170	18171	18172	18173	18174	18175	18176	18177	18178	18179	18180	18181
292	18182	18183	18184	18185	18186	18187	18188	18189	18190	18191	18192	18193

Chapter 10 Internal Memory Address of “Read/Write Variable Data” command

Step	Target position		Cir. int. auxiliary point		Operation speed		Dwell time	M code	Sub. Axis setting	Helical int.	Circular int. turns	Control word
	Low	High	Low	High	Low	High						
293	18194	18195	18196	18197	18198	18199	18200	18201	18202	18203	18204	18205
294	18206	18207	18208	18209	18210	18211	18212	18213	18214	18215	18216	18217
295	18218	18219	18220	18221	18222	18223	18224	18225	18226	18227	18228	18229
296	18230	18231	18232	18233	18234	18235	18236	18237	18238	18239	18240	18241
297	18242	18243	18244	18245	18246	18247	18248	18249	18250	18251	18252	18253
298	18254	18255	18256	18257	18258	18259	18260	18261	18262	18263	18264	18265
299	18266	18267	18268	18269	18270	18271	18272	18273	18274	18275	18276	18277
300	18278	18279	18280	18281	18282	18283	18284	18285	18286	18287	18288	18289
301	18290	18291	18292	18293	18294	18295	18296	18297	18298	18299	18300	18301
302	18302	18303	18304	18305	18306	18307	18308	18309	18310	18311	18312	18313
303	18314	18315	18316	18317	18318	18319	18320	18321	18322	18323	18324	18325
304	18326	18327	18328	18329	18330	18331	18332	18333	18334	18335	18336	18337
305	18338	18339	18340	18341	18342	18343	18344	18345	18346	18347	18348	18349
306	18350	18351	18352	18353	18354	18355	18356	18357	18358	18359	18360	18361
307	18362	18363	18364	18365	18366	18367	18368	18369	18370	18371	18372	18373
308	18374	18375	18376	18377	18378	18379	18380	18381	18382	18383	18384	18385
309	18386	18387	18388	18389	18390	18391	18392	18393	18394	18395	18396	18397
310	18398	18399	18400	18401	18402	18403	18404	18405	18406	18407	18408	18409
311	18410	18411	18412	18413	18414	18415	18416	18417	18418	18419	18420	18421
312	18422	18423	18424	18425	18426	18427	18428	18429	18430	18431	18432	18433
313	18434	18435	18436	18437	18438	18439	18440	18441	18442	18443	18444	18445
314	18446	18447	18448	18449	18450	18451	18452	18453	18454	18455	18456	18457
315	18458	18459	18460	18461	18462	18463	18464	18465	18466	18467	18468	18469
316	18470	18471	18472	18473	18474	18475	18476	18477	18478	18479	18480	18481
317	18482	18483	18484	18485	18486	18487	18488	18489	18490	18491	18492	18493
318	18494	18495	18496	18497	18498	18499	18500	18501	18502	18503	18504	18505
319	18506	18507	18508	18509	18510	18511	18512	18513	18514	18515	18516	18517
320	18518	18519	18520	18521	18522	18523	18524	18525	18526	18527	18528	18529
321	18530	18531	18532	18533	18534	18535	18536	18537	18538	18539	18540	18541
322	18542	18543	18544	18545	18546	18547	18548	18549	18550	18551	18552	18553
323	18554	18555	18556	18557	18558	18559	18560	18561	18562	18563	18564	18565
324	18566	18567	18568	18569	18570	18571	18572	18573	18574	18575	18576	18577
325	18578	18579	18580	18581	18582	18583	18584	18585	18586	18587	18588	18589
326	18590	18591	18592	18593	18594	18595	18596	18597	18598	18599	18600	18601
327	18602	18603	18604	18605	18606	18607	18608	18609	18610	18611	18612	18613
328	18614	18615	18616	18617	18618	18619	18620	18621	18622	18623	18624	18625
329	18626	18627	18628	18629	18630	18631	18632	18633	18634	18635	18636	18637
330	18638	18639	18640	18641	18642	18643	18644	18645	18646	18647	18648	18649
331	18650	18651	18652	18653	18654	18655	18656	18657	18658	18659	18660	18661
332	18662	18663	18664	18665	18666	18667	18668	18669	18670	18671	18672	18673
333	18674	18675	18676	18677	18678	18679	18680	18681	18682	18683	18684	18685
334	18686	18687	18688	18689	18690	18691	18692	18693	18694	18695	18696	18697
335	18698	18699	18700	18701	18702	18703	18704	18705	18706	18707	18708	18709
336	18710	18711	18712	18713	18714	18715	18716	18717	18718	18719	18720	18721
337	18722	18723	18724	18725	18726	18727	18728	18729	18730	18731	18732	18733
338	18734	18735	18736	18737	18738	18739	18740	18741	18742	18743	18744	18745
339	18746	18747	18748	18749	18750	18751	18752	18753	18754	18755	18756	18757
340	18758	18759	18760	18761	18762	18763	18764	18765	18766	18767	18768	18769
341	18770	18771	18772	18773	18774	18775	18776	18777	18778	18779	18780	18781

Chapter 10 Internal Memory Address of “Read/Write Variable Data” command

Step	Target position		Cir. int. auxiliary point		Operation speed		Dwell time	M code	Sub. Axis setting	Helical int.	Circular int. turns	Control word
	Low	High	Low	High	Low	High						
342	18782	18783	18784	18785	18786	18787	18788	18789	18790	18791	18792	18793
343	18794	18795	18796	18797	18798	18799	18800	18801	18802	18803	18804	18805
344	18806	18807	18808	18809	18810	18811	18812	18813	18814	18815	18816	18817
345	18818	18819	18820	18821	18822	18823	18824	18825	18826	18827	18828	18829
346	18830	18831	18832	18833	18834	18835	18836	18837	18838	18839	18840	18841
347	18842	18843	18844	18845	18846	18847	18848	18849	18850	18851	18852	18853
348	18854	18855	18856	18857	18858	18859	18860	18861	18862	18863	18864	18865
349	18866	18867	18868	18869	18870	18871	18872	18873	18874	18875	18876	18877
350	18878	18879	18880	18881	18882	18883	18884	18885	18886	18887	18888	18889
351	18890	18891	18892	18893	18894	18895	18896	18897	18898	18899	18900	18901
352	18902	18903	18904	18905	18906	18907	18908	18909	18910	18911	18912	18913
353	18914	18915	18916	18917	18918	18919	18920	18921	18922	18923	18924	18925
354	18926	18927	18928	18929	18930	18931	18932	18933	18934	18935	18936	18937
355	18938	18939	18940	18941	18942	18943	18944	18945	18946	18947	18948	18949
356	18950	18951	18952	18953	18954	18955	18956	18957	18958	18959	18960	18961
357	18962	18963	18964	18965	18966	18967	18968	18969	18970	18971	18972	18973
358	18974	18975	18976	18977	18978	18979	18980	18981	18982	18983	18984	18985
359	18986	18987	18988	18989	18990	18991	18992	18993	18994	18995	18996	18997
360	18998	18999	19000	19001	19002	19003	19004	19005	19006	19007	19008	19009
361	19010	19011	19012	19013	19014	19015	19016	19017	19018	19019	19020	19021
362	19022	19023	19024	19025	19026	19027	19028	19029	19030	19031	19032	19033
363	19034	19035	19036	19037	19038	19039	19040	19041	19042	19043	19044	19045
364	19046	19047	19048	19049	19050	19051	19052	19053	19054	19055	19056	19057
365	19058	19059	19060	19061	19062	19063	19064	19065	19066	19067	19068	19069
366	19070	19071	19072	19073	19074	19075	19076	19077	19078	19079	19080	19081
367	19082	19083	19084	19085	19086	19087	19088	19089	19090	19091	19092	19093
368	19094	19095	19096	19097	19098	19099	19100	19101	19102	19103	19104	19105
369	19106	19107	19108	19109	19110	19111	19112	19113	19114	19115	19116	19117
370	19118	19119	19120	19121	19122	19123	19124	19125	19126	19127	19128	19129
371	19130	19131	19132	19133	19134	19135	19136	19137	19138	19139	19140	19141
372	19142	19143	19144	19145	19146	19147	19148	19149	19150	19151	19152	19153
373	19154	19155	19156	19157	19158	19159	19160	19161	19162	19163	19164	19165
374	19166	19167	19168	19169	19170	19171	19172	19173	19174	19175	19176	19177
375	19178	19179	19180	19181	19182	19183	19184	19185	19186	19187	19188	19189
376	19190	19191	19192	19193	19194	19195	19196	19197	19198	19199	19200	19201
377	19202	19203	19204	19205	19206	19207	19208	19209	19210	19211	19212	19213
378	19214	19215	19216	19217	19218	19219	19220	19221	19222	19223	19224	19225
379	19226	19227	19228	19229	19230	19231	19232	19233	19234	19235	19236	19237
380	19238	19239	19240	19241	19242	19243	19244	19245	19246	19247	19248	19249
381	19250	19251	19252	19253	19254	19255	19256	19257	19258	19259	19260	19261
382	19262	19263	19264	19265	19266	19267	19268	19269	19270	19271	19272	19273
383	19274	19275	19276	19277	19278	19279	19280	19281	19282	19283	19284	19285
384	19286	19287	19288	19289	19290	19291	19292	19293	19294	19295	19296	19297
385	19298	19299	19300	19301	19302	19303	19304	19305	19306	19307	19308	19309
386	19310	19311	19312	19313	19314	19315	19316	19317	19318	19319	19320	19321
387	19322	19323	19324	19325	19326	19327	19328	19329	19330	19331	19332	19333
388	19334	19335	19336	19337	19338	19339	19340	19341	19342	19343	19344	19345
389	19346	19347	19348	19349	19350	19351	19352	19353	19354	19355	19356	19357
390	19358	19359	19360	19361	19362	19363	19364	19365	19366	19367	19368	19369

Chapter 10 Internal Memory Address of “Read/Write Variable Data” command

Step	Target position		Cir. int. auxiliary point		Operation speed		Dwell time	M code	Sub. Axis setting	Helical int.	Circular int. turns	Control word
	Low	High	Low	High	Low	High						
391	19370	19371	19372	19373	19374	19375	19376	19377	19378	19379	19380	19381
392	19382	19383	19384	19385	19386	19387	19388	19389	19390	19391	19392	19393
393	19394	19395	19396	19397	19398	19399	19400	19401	19402	19403	19404	19405
394	19406	19407	19408	19409	19410	19411	19412	19413	19414	19415	19416	19417
395	19418	19419	19420	19421	19422	19423	19424	19425	19426	19427	19428	19429
396	19430	19431	19432	19433	19434	19435	19436	19437	19438	19439	19440	19441
397	19442	19443	19444	19445	19446	19447	19448	19449	19450	19451	19452	19453
398	19454	19455	19456	19457	19458	19459	19460	19461	19462	19463	19464	19465
399	19466	19467	19468	19469	19470	19471	19472	19473	19474	19475	19476	19477
400	19478	19479	19480	19481	19482	19483	19484	19485	19486	19487	19488	19489

10.6 CAM data memory address

	Block 1	Block 2	Block 3	Block 4	Block 5	Block 6	Block 7	
Main axis travel distance per rotation	19490	23720	27950	32180	36410	40640	44870	
Main axis pulse per rotation	19492	23722	27952	32182	36412	40642	44872	
Sub axis travel distance per rotation	19494	23724	27954	32184	36414	40644	44874	
Sub axis pulse per rotation	19496	23726	27956	32186	36416	40646	44876	
CAM Data End Step(WORD)	19498	23728	27958	32188	36418	40648	44878	
CAM Data Info(WORD) Bit 0~1 : main axis unit Bit 2~3 : Sub axis unit Bit 8 : CAM mode (0: repeat,1: increase)	19499	23729	27959	32189	36419	40649	44879	
User Data[0]	Main axis end pos.	19500	23730	27960	32190	36420	40650	44880
	Sub axis end pos.	19502	23732	27962	32192	36422	40652	44882
	CAM Curve	19504	23734	27964	32194	36424	40654	44884
User Data[1]	Main axis end pos.	19506	23736	27966	32196	36426	40656	44886
	Sub axis end pos.	19508	23738	27968	32198	36428	40658	44888
	CAM Curve	19510	23740	27970	32200	36430	40660	44890
User Data[2]	Main axis end pos.	19512	23742	27972	32202	36432	40662	44892
	Sub axis end pos.	19514	23744	27974	32204	36434	40664	44894
	CAM Curve	19516	23746	27976	32206	36436	40666	44896
User Data[3]	Main axis end pos.	19518	23748	27978	32208	36438	40668	44898
	Sub axis end pos.	19520	23750	27980	32210	36440	40670	44900
	CAM Curve	19522	23752	27982	32212	36442	40672	44902
User Data[4]	Main axis end pos.	19524	23754	27984	32214	36444	40674	44904
	Sub axis end pos.	19526	23756	27986	32216	36446	40676	44906
	CAM Curve	19528	23758	27988	32218	36448	40678	44908
User Data[5]	Main axis end pos.	19530	23760	27990	32220	36450	40680	44910
	Sub axis end pos.	19532	23762	27992	32222	36452	40682	44912
	CAM Curve	19534	23764	27994	32224	36454	40684	44914
User Data[6]	Main axis end pos.	19536	23766	27996	32226	36456	40686	44916
	Sub axis end pos.	19538	23768	27998	32228	36458	40688	44918
	CAM Curve	19540	23770	28000	32230	36460	40690	44920
User Data[7]	Main axis end pos.	19542	23772	28002	32232	36462	40692	44922
	Sub axis end pos.	19544	23774	28004	32234	36464	40694	44924
	CAM Curve	19546	23776	28006	32236	36466	40696	44926
User Data[8]	Main axis end pos.	19548	23778	28008	32238	36468	40698	44928
	Sub axis end pos.	19550	23780	28010	32240	36470	40700	44930
	CAM Curve	19552	23782	28012	32242	36472	40702	44932
User Data[9]	Main axis end pos.	19554	23784	28014	32244	36474	40704	44934
	Sub axis end pos.	19556	23786	28016	32246	36476	40706	44936
	CAM Curve	19558	23788	28018	32248	36478	40708	44938
User Data[10]	Main axis end pos.	19560	23790	28020	32250	36480	40710	44940
	Sub axis end pos.	19562	23792	28022	32252	36482	40712	44942
	CAM Curve	19564	23794	28024	32254	36484	40714	44944

Chapter 10 Internal Memory Address of “Read/Write Variable Data” command

	Block 1	Block 2	Block 3	Block 4	Block 5	Block 6	Block 7	
Main axis travel distance per rotation	19490	23720	27950	32180	36410	40640	44870	
Main axis pulse per rotation	19492	23722	27952	32182	36412	40642	44872	
Sub axis travel distance per rotation	19494	23724	27954	32184	36414	40644	44874	
Sub axis pulse per rotation	19496	23726	27956	32186	36416	40646	44876	
CAM Data End Step(WORD)	19498	23728	27958	32188	36418	40648	44878	
CAM Data Info(WORD) Bit 0~1 : main axis unit Bit 2~3 : Sub axis unit Bit 8 : CAM mode (0: repeat,1: increase)	19499	23729	27959	32189	36419	40649	44879	
User Data[11]	Main axis end pos.	19566	23796	28026	32256	36486	40716	44946
	Sub axis end pos.	19568	23798	28028	32258	36488	40718	44948
	CAM Curve	19570	23800	28030	32260	36490	40720	44950
User Data[12]	Main axis end pos.	19572	23802	28032	32262	36492	40722	44952
	Sub axis end pos.	19574	23804	28034	32264	36494	40724	44954
	CAM Curve	19576	23806	28036	32266	36496	40726	44956
User Data[13]	Main axis end pos.	19578	23808	28038	32268	36498	40728	44958
	Sub axis end pos.	19580	23810	28040	32270	36500	40730	44960
	CAM Curve	19582	23812	28042	32272	36502	40732	44962
User Data[14]	Main axis end pos.	19584	23814	28044	32274	36504	40734	44964
	Sub axis end pos.	19586	23816	28046	32276	36506	40736	44966
	CAM Curve	19588	23818	28048	32278	36508	40738	44968
User Data[15]	Main axis end pos.	19590	23820	28050	32280	36510	40740	44970
	Sub axis end pos.	19592	23822	28052	32282	36512	40742	44972
	CAM Curve	19594	23824	28054	32284	36514	40744	44974
User Data[16]	Main axis end pos.	19596	23826	28056	32286	36516	40746	44976
	Sub axis end pos.	19598	23828	28058	32288	36518	40748	44978
	CAM Curve	19600	23830	28060	32290	36520	40750	44980
User Data[17]	Main axis end pos.	19602	23832	28062	32292	36522	40752	44982
	Sub axis end pos.	19604	23834	28064	32294	36524	40754	44984
	CAM Curve	19606	23836	28066	32296	36526	40756	44986
User Data[18]	Main axis end pos.	19608	23838	28068	32298	36528	40758	44988
	Sub axis end pos.	19610	23840	28070	32300	36530	40760	44990
	CAM Curve	19612	23842	28072	32302	36532	40762	44992
User Data[19]	Main axis end pos.	19614	23844	28074	32304	36534	40764	44994
	Sub axis end pos.	19616	23846	28076	32306	36536	40766	44996
	CAM Curve	19618	23848	28078	32308	36538	40768	44998
Step Offset	19620	23850	28080	32310	36540	40770	45000	
Total_Length	19622	23852	28082	32312	36542	40772	45002	
CAM Data[0]	19624	23854	28084	32314	36544	40774	45004	
CAM Data[1]	19626	23856	28086	32316	36546	40776	45006	
CAM Data[2]	19628	23858	28088	32318	36548	40778	45008	
CAM Data[3]	19630	23860	28090	32320	36550	40780	45010	
CAM Data[4]	19632	23862	28092	32322	36552	40782	45012	
CAM Data[5]	19634	23864	28094	32324	36554	40784	45014	

Chapter 10 Internal Memory Address of “Read/Write Variable Data” command

	Block 1	Block 2	Block 3	Block 4	Block 5	Block 6	Block 7
CAM Data[6]	19636	23866	28096	32326	36556	40786	45016
CAM Data[7]	19638	23868	28098	32328	36558	40788	45018
CAM Data[8]	19640	23870	28100	32330	36560	40790	45020
CAM Data[9]	19642	23872	28102	32332	36562	40792	45022
CAM Data[10]	19644	23874	28104	32334	36564	40794	45024
CAM Data[11]	19646	23876	28106	32336	36566	40796	45026
CAM Data[12]	19648	23878	28108	32338	36568	40798	45028
CAM Data[13]	19650	23880	28110	32340	36570	40800	45030
CAM Data[14]	19652	23882	28112	32342	36572	40802	45032
CAM Data[15]	19654	23884	28114	32344	36574	40804	45034
CAM Data[16]	19656	23886	28116	32346	36576	40806	45036
CAM Data[17]	19658	23888	28118	32348	36578	40808	45038
CAM Data[18]	19660	23890	28120	32350	36580	40810	45040
CAM Data[19]	19662	23892	28122	32352	36582	40812	45042
CAM Data[20]	19664	23894	28124	32354	36584	40814	45044
CAM Data[21]	19666	23896	28126	32356	36586	40816	45046
CAM Data[22]	19668	23898	28128	32358	36588	40818	45048
CAM Data[23]	19670	23900	28130	32360	36590	40820	45050
CAM Data[24]	19672	23902	28132	32362	36592	40822	45052
CAM Data[25]	19674	23904	28134	32364	36594	40824	45054
CAM Data[26]	19676	23906	28136	32366	36596	40826	45056
CAM Data[27]	19678	23908	28138	32368	36598	40828	45058
CAM Data[28]	19680	23910	28140	32370	36600	40830	45060
CAM Data[29]	19682	23912	28142	32372	36602	40832	45062
CAM Data[30]	19684	23914	28144	32374	36604	40834	45064
CAM Data[31]	19686	23916	28146	32376	36606	40836	45066
CAM Data[32]	19688	23918	28148	32378	36608	40838	45068
CAM Data[33]	19690	23920	28150	32380	36610	40840	45070
CAM Data[34]	19692	23922	28152	32382	36612	40842	45072
CAM Data[35]	19694	23924	28154	32384	36614	40844	45074
CAM Data[36]	19696	23926	28156	32386	36616	40846	45076
CAM Data[37]	19698	23928	28158	32388	36618	40848	45078
CAM Data[38]	19700	23930	28160	32390	36620	40850	45080
CAM Data[39]	19702	23932	28162	32392	36622	40852	45082
CAM Data[40]	19704	23934	28164	32394	36624	40854	45084
CAM Data[41]	19706	23936	28166	32396	36626	40856	45086
CAM Data[42]	19708	23938	28168	32398	36628	40858	45088
CAM Data[43]	19710	23940	28170	32400	36630	40860	45090
CAM Data[44]	19712	23942	28172	32402	36632	40862	45092
CAM Data[45]	19714	23944	28174	32404	36634	40864	45094
CAM Data[46]	19716	23946	28176	32406	36636	40866	45096
CAM Data[47]	19718	23948	28178	32408	36638	40868	45098
CAM Data[48]	19720	23950	28180	32410	36640	40870	45100
CAM Data[49]	19722	23952	28182	32412	36642	40872	45102

Chapter 10 Internal Memory Address of “Read/Write Variable Data” command

	Block 1	Block 2	Block 3	Block 4	Block 5	Block 6	Block 7
CAM Data[50]	19724	23954	28184	32414	36644	40874	45104
CAM Data[51]	19726	23956	28186	32416	36646	40876	45106
CAM Data[52]	19728	23958	28188	32418	36648	40878	45108
CAM Data[53]	19730	23960	28190	32420	36650	40880	45110
CAM Data[54]	19732	23962	28192	32422	36652	40882	45112
CAM Data[55]	19734	23964	28194	32424	36654	40884	45114
CAM Data[56]	19736	23966	28196	32426	36656	40886	45116
CAM Data[57]	19738	23968	28198	32428	36658	40888	45118
CAM Data[58]	19740	23970	28200	32430	36660	40890	45120
CAM Data[59]	19742	23972	28202	32432	36662	40892	45122
CAM Data[60]	19744	23974	28204	32434	36664	40894	45124
CAM Data[61]	19746	23976	28206	32436	36666	40896	45126
CAM Data[62]	19748	23978	28208	32438	36668	40898	45128
CAM Data[63]	19750	23980	28210	32440	36670	40900	45130
CAM Data[64]	19752	23982	28212	32442	36672	40902	45132
CAM Data[65]	19754	23984	28214	32444	36674	40904	45134
CAM Data[66]	19756	23986	28216	32446	36676	40906	45136
CAM Data[67]	19758	23988	28218	32448	36678	40908	45138
CAM Data[68]	19760	23990	28220	32450	36680	40910	45140
CAM Data[69]	19762	23992	28222	32452	36682	40912	45142
CAM Data[70]	19764	23994	28224	32454	36684	40914	45144
CAM Data[71]	19766	23996	28226	32456	36686	40916	45146
CAM Data[72]	19768	23998	28228	32458	36688	40918	45148
CAM Data[73]	19770	24000	28230	32460	36690	40920	45150
CAM Data[74]	19772	24002	28232	32462	36692	40922	45152
CAM Data[75]	19774	24004	28234	32464	36694	40924	45154
CAM Data[76]	19776	24006	28236	32466	36696	40926	45156
CAM Data[77]	19778	24008	28238	32468	36698	40928	45158
CAM Data[78]	19780	24010	28240	32470	36700	40930	45160
CAM Data[79]	19782	24012	28242	32472	36702	40932	45162
CAM Data[80]	19784	24014	28244	32474	36704	40934	45164
CAM Data[81]	19786	24016	28246	32476	36706	40936	45166
CAM Data[82]	19788	24018	28248	32478	36708	40938	45168
CAM Data[83]	19790	24020	28250	32480	36710	40940	45170
CAM Data[84]	19792	24022	28252	32482	36712	40942	45172
CAM Data[85]	19794	24024	28254	32484	36714	40944	45174
CAM Data[86]	19796	24026	28256	32486	36716	40946	45176
CAM Data[87]	19798	24028	28258	32488	36718	40948	45178
CAM Data[88]	19800	24030	28260	32490	36720	40950	45180
CAM Data[89]	19802	24032	28262	32492	36722	40952	45182
CAM Data[90]	19804	24034	28264	32494	36724	40954	45184
CAM Data[91]	19806	24036	28266	32496	36726	40956	45186
CAM Data[92]	19808	24038	28268	32498	36728	40958	45188
CAM Data[93]	19810	24040	28270	32500	36730	40960	45190

Chapter 10 Internal Memory Address of “Read/Write Variable Data” command

	Block 1	Block 2	Block 3	Block 4	Block 5	Block 6	Block 7
CAM Data[94]	19812	24042	28272	32502	36732	40962	45192
CAM Data[95]	19814	24044	28274	32504	36734	40964	45194
CAM Data[96]	19816	24046	28276	32506	36736	40966	45196
CAM Data[97]	19818	24048	28278	32508	36738	40968	45198
CAM Data[98]	19820	24050	28280	32510	36740	40970	45200
CAM Data[99]	19822	24052	28282	32512	36742	40972	45202
CAM Data[100]	19824	24054	28284	32514	36744	40974	45204
CAM Data[101]	19826	24056	28286	32516	36746	40976	45206
CAM Data[102]	19828	24058	28288	32518	36748	40978	45208
CAM Data[103]	19830	24060	28290	32520	36750	40980	45210
CAM Data[104]	19832	24062	28292	32522	36752	40982	45212
CAM Data[105]	19834	24064	28294	32524	36754	40984	45214
CAM Data[106]	19836	24066	28296	32526	36756	40986	45216
CAM Data[107]	19838	24068	28298	32528	36758	40988	45218
CAM Data[108]	19840	24070	28300	32530	36760	40990	45220
CAM Data[109]	19842	24072	28302	32532	36762	40992	45222
CAM Data[110]	19844	24074	28304	32534	36764	40994	45224
CAM Data[111]	19846	24076	28306	32536	36766	40996	45226
CAM Data[112]	19848	24078	28308	32538	36768	40998	45228
CAM Data[113]	19850	24080	28310	32540	36770	41000	45230
CAM Data[114]	19852	24082	28312	32542	36772	41002	45232
CAM Data[115]	19854	24084	28314	32544	36774	41004	45234
CAM Data[116]	19856	24086	28316	32546	36776	41006	45236
CAM Data[117]	19858	24088	28318	32548	36778	41008	45238
CAM Data[118]	19860	24090	28320	32550	36780	41010	45240
CAM Data[119]	19862	24092	28322	32552	36782	41012	45242
CAM Data[120]	19864	24094	28324	32554	36784	41014	45244
CAM Data[121]	19866	24096	28326	32556	36786	41016	45246
CAM Data[122]	19868	24098	28328	32558	36788	41018	45248
CAM Data[123]	19870	24100	28330	32560	36790	41020	45250
CAM Data[124]	19872	24102	28332	32562	36792	41022	45252
CAM Data[125]	19874	24104	28334	32564	36794	41024	45254
CAM Data[126]	19876	24106	28336	32566	36796	41026	45256
CAM Data[127]	19878	24108	28338	32568	36798	41028	45258
CAM Data[128]	19880	24110	28340	32570	36800	41030	45260
CAM Data[129]	19882	24112	28342	32572	36802	41032	45262
CAM Data[130]	19884	24114	28344	32574	36804	41034	45264
CAM Data[131]	19886	24116	28346	32576	36806	41036	45266
CAM Data[132]	19888	24118	28348	32578	36808	41038	45268
CAM Data[133]	19890	24120	28350	32580	36810	41040	45270
CAM Data[134]	19892	24122	28352	32582	36812	41042	45272
CAM Data[135]	19894	24124	28354	32584	36814	41044	45274
CAM Data[136]	19896	24126	28356	32586	36816	41046	45276
CAM Data[137]	19898	24128	28358	32588	36818	41048	45278
CAM Data[138]	19900	24130	28360	32590	36820	41050	45280

Chapter 10 Internal Memory Address of “Read/Write Variable Data” command

	Block 1	Block 2	Block 3	Block 4	Block 5	Block 6	Block 7
CAM Data[139]	19902	24132	28362	32592	36822	41052	45282
CAM Data[140]	19904	24134	28364	32594	36824	41054	45284
CAM Data[141]	19906	24136	28366	32596	36826	41056	45286
CAM Data[142]	19908	24138	28368	32598	36828	41058	45288
CAM Data[143]	19910	24140	28370	32600	36830	41060	45290
CAM Data[144]	19912	24142	28372	32602	36832	41062	45292
CAM Data[145]	19914	24144	28374	32604	36834	41064	45294
CAM Data[146]	19916	24146	28376	32606	36836	41066	45296
CAM Data[147]	19918	24148	28378	32608	36838	41068	45298
CAM Data[148]	19920	24150	28380	32610	36840	41070	45300
CAM Data[149]	19922	24152	28382	32612	36842	41072	45302
CAM Data[150]	19924	24154	28384	32614	36844	41074	45304
CAM Data[151]	19926	24156	28386	32616	36846	41076	45306
CAM Data[152]	19928	24158	28388	32618	36848	41078	45308
CAM Data[153]	19930	24160	28390	32620	36850	41080	45310
CAM Data[154]	19932	24162	28392	32622	36852	41082	45312
CAM Data[155]	19934	24164	28394	32624	36854	41084	45314
CAM Data[156]	19936	24166	28396	32626	36856	41086	45316
CAM Data[157]	19938	24168	28398	32628	36858	41088	45318
CAM Data[158]	19940	24170	28400	32630	36860	41090	45320
CAM Data[159]	19942	24172	28402	32632	36862	41092	45322
CAM Data[160]	19944	24174	28404	32634	36864	41094	45324
CAM Data[161]	19946	24176	28406	32636	36866	41096	45326
CAM Data[162]	19948	24178	28408	32638	36868	41098	45328
CAM Data[163]	19950	24180	28410	32640	36870	41100	45330
CAM Data[164]	19952	24182	28412	32642	36872	41102	45332
CAM Data[165]	19954	24184	28414	32644	36874	41104	45334
CAM Data[166]	19956	24186	28416	32646	36876	41106	45336
CAM Data[167]	19958	24188	28418	32648	36878	41108	45338
CAM Data[168]	19960	24190	28420	32650	36880	41110	45340
CAM Data[169]	19962	24192	28422	32652	36882	41112	45342
CAM Data[170]	19964	24194	28424	32654	36884	41114	45344
CAM Data[171]	19966	24196	28426	32656	36886	41116	45346
CAM Data[172]	19968	24198	28428	32658	36888	41118	45348
CAM Data[173]	19970	24200	28430	32660	36890	41120	45350
CAM Data[174]	19972	24202	28432	32662	36892	41122	45352
CAM Data[175]	19974	24204	28434	32664	36894	41124	45354
CAM Data[176]	19976	24206	28436	32666	36896	41126	45356
CAM Data[177]	19978	24208	28438	32668	36898	41128	45358
CAM Data[178]	19980	24210	28440	32670	36900	41130	45360
CAM Data[179]	19982	24212	28442	32672	36902	41132	45362
CAM Data[180]	19984	24214	28444	32674	36904	41134	45364
CAM Data[181]	19986	24216	28446	32676	36906	41136	45366
CAM Data[182]	19988	24218	28448	32678	36908	41138	45368

Chapter 10 Internal Memory Address of “Read/Write Variable Data” command

	Block 1	Block 2	Block 3	Block 4	Block 5	Block 6	Block 7
CAM Data[183]	19990	24220	28450	32680	36910	41140	45370
CAM Data[184]	19992	24222	28452	32682	36912	41142	45372
CAM Data[185]	19994	24224	28454	32684	36914	41144	45374
CAM Data[186]	19996	24226	28456	32686	36916	41146	45376
CAM Data[187]	19998	24228	28458	32688	36918	41148	45378
CAM Data[188]	20000	24230	28460	32690	36920	41150	45380
CAM Data[189]	20002	24232	28462	32692	36922	41152	45382
CAM Data[190]	20004	24234	28464	32694	36924	41154	45384
CAM Data[191]	20006	24236	28466	32696	36926	41156	45386
CAM Data[192]	20008	24238	28468	32698	36928	41158	45388
CAM Data[193]	20010	24240	28470	32700	36930	41160	45390
CAM Data[194]	20012	24242	28472	32702	36932	41162	45392
CAM Data[195]	20014	24244	28474	32704	36934	41164	45394
CAM Data[196]	20016	24246	28476	32706	36936	41166	45396
CAM Data[197]	20018	24248	28478	32708	36938	41168	45398
CAM Data[198]	20020	24250	28480	32710	36940	41170	45400
CAM Data[199]	20022	24252	28482	32712	36942	41172	45402
CAM Data[200]	20024	24254	28484	32714	36944	41174	45404
CAM Data[201]	20026	24256	28486	32716	36946	41176	45406
CAM Data[202]	20028	24258	28488	32718	36948	41178	45408
CAM Data[203]	20030	24260	28490	32720	36950	41180	45410
CAM Data[204]	20032	24262	28492	32722	36952	41182	45412
CAM Data[205]	20034	24264	28494	32724	36954	41184	45414
CAM Data[206]	20036	24266	28496	32726	36956	41186	45416
CAM Data[207]	20038	24268	28498	32728	36958	41188	45418
CAM Data[208]	20040	24270	28500	32730	36960	41190	45420
CAM Data[209]	20042	24272	28502	32732	36962	41192	45422
CAM Data[210]	20044	24274	28504	32734	36964	41194	45424
CAM Data[211]	20046	24276	28506	32736	36966	41196	45426
CAM Data[212]	20048	24278	28508	32738	36968	41198	45428
CAM Data[213]	20050	24280	28510	32740	36970	41200	45430
CAM Data[214]	20052	24282	28512	32742	36972	41202	45432
CAM Data[215]	20054	24284	28514	32744	36974	41204	45434
CAM Data[216]	20056	24286	28516	32746	36976	41206	45436
CAM Data[217]	20058	24288	28518	32748	36978	41208	45438
CAM Data[218]	20060	24290	28520	32750	36980	41210	45440
CAM Data[219]	20062	24292	28522	32752	36982	41212	45442
CAM Data[220]	20064	24294	28524	32754	36984	41214	45444
CAM Data[221]	20066	24296	28526	32756	36986	41216	45446
CAM Data[222]	20068	24298	28528	32758	36988	41218	45448
CAM Data[223]	20070	24300	28530	32760	36990	41220	45450
CAM Data[224]	20072	24302	28532	32762	36992	41222	45452
CAM Data[225]	20074	24304	28534	32764	36994	41224	45454
CAM Data[226]	20076	24306	28536	32766	36996	41226	45456

Chapter 10 Internal Memory Address of “Read/Write Variable Data” command

	Block 1	Block 2	Block 3	Block 4	Block 5	Block 6	Block 7
CAM Data[227]	20078	24308	28538	32768	36998	41228	45458
CAM Data[228]	20080	24310	28540	32770	37000	41230	45460
CAM Data[229]	20082	24312	28542	32772	37002	41232	45462
CAM Data[230]	20084	24314	28544	32774	37004	41234	45464
CAM Data[231]	20086	24316	28546	32776	37006	41236	45466
CAM Data[232]	20088	24318	28548	32778	37008	41238	45468
CAM Data[233]	20090	24320	28550	32780	37010	41240	45470
CAM Data[234]	20092	24322	28552	32782	37012	41242	45472
CAM Data[235]	20094	24324	28554	32784	37014	41244	45474
CAM Data[236]	20096	24326	28556	32786	37016	41246	45476
CAM Data[237]	20098	24328	28558	32788	37018	41248	45478
CAM Data[238]	20100	24330	28560	32790	37020	41250	45480
CAM Data[239]	20102	24332	28562	32792	37022	41252	45482
CAM Data[240]	20104	24334	28564	32794	37024	41254	45484
CAM Data[241]	20106	24336	28566	32796	37026	41256	45486
CAM Data[242]	20108	24338	28568	32798	37028	41258	45488
CAM Data[243]	20110	24340	28570	32800	37030	41260	45490
CAM Data[244]	20112	24342	28572	32802	37032	41262	45492
CAM Data[245]	20114	24344	28574	32804	37034	41264	45494
CAM Data[246]	20116	24346	28576	32806	37036	41266	45496
CAM Data[247]	20118	24348	28578	32808	37038	41268	45498
CAM Data[248]	20120	24350	28580	32810	37040	41270	45500
CAM Data[249]	20122	24352	28582	32812	37042	41272	45502
CAM Data[250]	20124	24354	28584	32814	37044	41274	45504
CAM Data[251]	20126	24356	28586	32816	37046	41276	45506
CAM Data[252]	20128	24358	28588	32818	37048	41278	45508
CAM Data[253]	20130	24360	28590	32820	37050	41280	45510
CAM Data[254]	20132	24362	28592	32822	37052	41282	45512
CAM Data[255]	20134	24364	28594	32824	37054	41284	45514
CAM Data[256]	20136	24366	28596	32826	37056	41286	45516
CAM Data[257]	20138	24368	28598	32828	37058	41288	45518
CAM Data[258]	20140	24370	28600	32830	37060	41290	45520
CAM Data[259]	20142	24372	28602	32832	37062	41292	45522
CAM Data[260]	20144	24374	28604	32834	37064	41294	45524
CAM Data[261]	20146	24376	28606	32836	37066	41296	45526
CAM Data[262]	20148	24378	28608	32838	37068	41298	45528
CAM Data[263]	20150	24380	28610	32840	37070	41300	45530
CAM Data[264]	20152	24382	28612	32842	37072	41302	45532
CAM Data[265]	20154	24384	28614	32844	37074	41304	45534
CAM Data[266]	20156	24386	28616	32846	37076	41306	45536
CAM Data[267]	20158	24388	28618	32848	37078	41308	45538
CAM Data[268]	20160	24390	28620	32850	37080	41310	45540
CAM Data[269]	20162	24392	28622	32852	37082	41312	45542

Chapter 10 Internal Memory Address of “Read/Write Variable Data” command

	Block 1	Block 2	Block 3	Block 4	Block 5	Block 6	Block 7
CAM Data[270]	20164	24394	28624	32854	37084	41314	45544
CAM Data[271]	20166	24396	28626	32856	37086	41316	45546
CAM Data[272]	20168	24398	28628	32858	37088	41318	45548
CAM Data[273]	20170	24400	28630	32860	37090	41320	45550
CAM Data[274]	20172	24402	28632	32862	37092	41322	45552
CAM Data[275]	20174	24404	28634	32864	37094	41324	45554
CAM Data[276]	20176	24406	28636	32866	37096	41326	45556
CAM Data[277]	20178	24408	28638	32868	37098	41328	45558
CAM Data[278]	20180	24410	28640	32870	37100	41330	45560
CAM Data[279]	20182	24412	28642	32872	37102	41332	45562
CAM Data[280]	20184	24414	28644	32874	37104	41334	45564
CAM Data[281]	20186	24416	28646	32876	37106	41336	45566
CAM Data[282]	20188	24418	28648	32878	37108	41338	45568
CAM Data[283]	20190	24420	28650	32880	37110	41340	45570
CAM Data[284]	20192	24422	28652	32882	37112	41342	45572
CAM Data[285]	20194	24424	28654	32884	37114	41344	45574
CAM Data[286]	20196	24426	28656	32886	37116	41346	45576
CAM Data[287]	20198	24428	28658	32888	37118	41348	45578
CAM Data[288]	20200	24430	28660	32890	37120	41350	45580
CAM Data[289]	20202	24432	28662	32892	37122	41352	45582
CAM Data[290]	20204	24434	28664	32894	37124	41354	45584
CAM Data[291]	20206	24436	28666	32896	37126	41356	45586
CAM Data[292]	20208	24438	28668	32898	37128	41358	45588
CAM Data[293]	20210	24440	28670	32900	37130	41360	45590
CAM Data[294]	20212	24442	28672	32902	37132	41362	45592
CAM Data[295]	20214	24444	28674	32904	37134	41364	45594
CAM Data[296]	20216	24446	28676	32906	37136	41366	45596
CAM Data[297]	20218	24448	28678	32908	37138	41368	45598
CAM Data[298]	20220	24450	28680	32910	37140	41370	45600
CAM Data[299]	20222	24452	28682	32912	37142	41372	45602
CAM Data[300]	20224	24454	28684	32914	37144	41374	45604
CAM Data[301]	20226	24456	28686	32916	37146	41376	45606
CAM Data[302]	20228	24458	28688	32918	37148	41378	45608
CAM Data[303]	20230	24460	28690	32920	37150	41380	45610
CAM Data[304]	20232	24462	28692	32922	37152	41382	45612
CAM Data[305]	20234	24464	28694	32924	37154	41384	45614
CAM Data[306]	20236	24466	28696	32926	37156	41386	45616
CAM Data[307]	20238	24468	28698	32928	37158	41388	45618
CAM Data[308]	20240	24470	28700	32930	37160	41390	45620
CAM Data[309]	20242	24472	28702	32932	37162	41392	45622
CAM Data[310]	20244	24474	28704	32934	37164	41394	45624
CAM Data[311]	20246	24476	28706	32936	37166	41396	45626
CAM Data[312]	20248	24478	28708	32938	37168	41398	45628

Chapter 10 Internal Memory Address of “Read/Write Variable Data” command

	Block 1	Block 2	Block 3	Block 4	Block 5	Block 6	Block 7
CAM Data[313]	20250	24480	28710	32940	37170	41400	45630
CAM Data[314]	20252	24482	28712	32942	37172	41402	45632
CAM Data[315]	20254	24484	28714	32944	37174	41404	45634
CAM Data[316]	20256	24486	28716	32946	37176	41406	45636
CAM Data[317]	20258	24488	28718	32948	37178	41408	45638
CAM Data[318]	20260	24490	28720	32950	37180	41410	45640
CAM Data[319]	20262	24492	28722	32952	37182	41412	45642
CAM Data[320]	20264	24494	28724	32954	37184	41414	45644
CAM Data[321]	20266	24496	28726	32956	37186	41416	45646
CAM Data[322]	20268	24498	28728	32958	37188	41418	45648
CAM Data[323]	20270	24500	28730	32960	37190	41420	45650
CAM Data[324]	20272	24502	28732	32962	37192	41422	45652
CAM Data[325]	20274	24504	28734	32964	37194	41424	45654
CAM Data[326]	20276	24506	28736	32966	37196	41426	45656
CAM Data[327]	20278	24508	28738	32968	37198	41428	45658
CAM Data[328]	20280	24510	28740	32970	37200	41430	45660
CAM Data[329]	20282	24512	28742	32972	37202	41432	45662
CAM Data[330]	20284	24514	28744	32974	37204	41434	45664
CAM Data[331]	20286	24516	28746	32976	37206	41436	45666
CAM Data[332]	20288	24518	28748	32978	37208	41438	45668
CAM Data[333]	20290	24520	28750	32980	37210	41440	45670
CAM Data[334]	20292	24522	28752	32982	37212	41442	45672
CAM Data[335]	20294	24524	28754	32984	37214	41444	45674
CAM Data[336]	20296	24526	28756	32986	37216	41446	45676
CAM Data[337]	20298	24528	28758	32988	37218	41448	45678
CAM Data[338]	20300	24530	28760	32990	37220	41450	45680
CAM Data[339]	20302	24532	28762	32992	37222	41452	45682
CAM Data[340]	20304	24534	28764	32994	37224	41454	45684
CAM Data[341]	20306	24536	28766	32996	37226	41456	45686
CAM Data[342]	20308	24538	28768	32998	37228	41458	45688
CAM Data[343]	20310	24540	28770	33000	37230	41460	45690
CAM Data[344]	20312	24542	28772	33002	37232	41462	45692
CAM Data[345]	20314	24544	28774	33004	37234	41464	45694
CAM Data[346]	20316	24546	28776	33006	37236	41466	45696
CAM Data[347]	20318	24548	28778	33008	37238	41468	45698
CAM Data[348]	20320	24550	28780	33010	37240	41470	45700
CAM Data[349]	20322	24552	28782	33012	37242	41472	45702
CAM Data[350]	20324	24554	28784	33014	37244	41474	45704
CAM Data[351]	20326	24556	28786	33016	37246	41476	45706
CAM Data[352]	20328	24558	28788	33018	37248	41478	45708
CAM Data[353]	20330	24560	28790	33020	37250	41480	45710
CAM Data[354]	20332	24562	28792	33022	37252	41482	45712
CAM Data[355]	20334	24564	28794	33024	37254	41484	45714

Chapter 10 Internal Memory Address of “Read/Write Variable Data” command

	Block 1	Block 2	Block 3	Block 4	Block 5	Block 6	Block 7
CAM Data[356]	20336	24566	28796	33026	37256	41486	45716
CAM Data[357]	20338	24568	28798	33028	37258	41488	45718
CAM Data[358]	20340	24570	28800	33030	37260	41490	45720
CAM Data[359]	20342	24572	28802	33032	37262	41492	45722
CAM Data[360]	20344	24574	28804	33034	37264	41494	45724
CAM Data[361]	20346	24576	28806	33036	37266	41496	45726
CAM Data[362]	20348	24578	28808	33038	37268	41498	45728
CAM Data[363]	20350	24580	28810	33040	37270	41500	45730
CAM Data[364]	20352	24582	28812	33042	37272	41502	45732
CAM Data[365]	20354	24584	28814	33044	37274	41504	45734
CAM Data[366]	20356	24586	28816	33046	37276	41506	45736
CAM Data[367]	20358	24588	28818	33048	37278	41508	45738
CAM Data[368]	20360	24590	28820	33050	37280	41510	45740
CAM Data[369]	20362	24592	28822	33052	37282	41512	45742
CAM Data[370]	20364	24594	28824	33054	37284	41514	45744
CAM Data[371]	20366	24596	28826	33056	37286	41516	45746
CAM Data[372]	20368	24598	28828	33058	37288	41518	45748
CAM Data[373]	20370	24600	28830	33060	37290	41520	45750
CAM Data[374]	20372	24602	28832	33062	37292	41522	45752
CAM Data[375]	20374	24604	28834	33064	37294	41524	45754
CAM Data[376]	20376	24606	28836	33066	37296	41526	45756
CAM Data[377]	20378	24608	28838	33068	37298	41528	45758
CAM Data[378]	20380	24610	28840	33070	37300	41530	45760
CAM Data[379]	20382	24612	28842	33072	37302	41532	45762
CAM Data[380]	20384	24614	28844	33074	37304	41534	45764
CAM Data[381]	20386	24616	28846	33076	37306	41536	45766
CAM Data[382]	20388	24618	28848	33078	37308	41538	45768
CAM Data[383]	20390	24620	28850	33080	37310	41540	45770
CAM Data[384]	20392	24622	28852	33082	37312	41542	45772
CAM Data[385]	20394	24624	28854	33084	37314	41544	45774
CAM Data[386]	20396	24626	28856	33086	37316	41546	45776
CAM Data[387]	20398	24628	28858	33088	37318	41548	45778
CAM Data[388]	20400	24630	28860	33090	37320	41550	45780
CAM Data[389]	20402	24632	28862	33092	37322	41552	45782
CAM Data[390]	20404	24634	28864	33094	37324	41554	45784
CAM Data[391]	20406	24636	28866	33096	37326	41556	45786
CAM Data[392]	20408	24638	28868	33098	37328	41558	45788
CAM Data[393]	20410	24640	28870	33100	37330	41560	45790
CAM Data[394]	20412	24642	28872	33102	37332	41562	45792
CAM Data[395]	20414	24644	28874	33104	37334	41564	45794
CAM Data[396]	20416	24646	28876	33106	37336	41566	45796
CAM Data[397]	20418	24648	28878	33108	37338	41568	45798
CAM Data[398]	20420	24650	28880	33110	37340	41570	45800

Chapter 10 Internal Memory Address of “Read/Write Variable Data” command

	Block 1	Block 2	Block 3	Block 4	Block 5	Block 6	Block 7
CAM Data[399]	20422	24652	28882	33112	37342	41572	45802
CAM Data[400]	20424	24654	28884	33114	37344	41574	45804
CAM Data[401]	20426	24656	28886	33116	37346	41576	45806
CAM Data[402]	20428	24658	28888	33118	37348	41578	45808
CAM Data[403]	20430	24660	28890	33120	37350	41580	45810
CAM Data[404]	20432	24662	28892	33122	37352	41582	45812
CAM Data[405]	20434	24664	28894	33124	37354	41584	45814
CAM Data[406]	20436	24666	28896	33126	37356	41586	45816
CAM Data[407]	20438	24668	28898	33128	37358	41588	45818
CAM Data[408]	20440	24670	28900	33130	37360	41590	45820
CAM Data[409]	20442	24672	28902	33132	37362	41592	45822
CAM Data[410]	20444	24674	28904	33134	37364	41594	45824
CAM Data[411]	20446	24676	28906	33136	37366	41596	45826
CAM Data[412]	20448	24678	28908	33138	37368	41598	45828
CAM Data[413]	20450	24680	28910	33140	37370	41600	45830
CAM Data[414]	20452	24682	28912	33142	37372	41602	45832
CAM Data[415]	20454	24684	28914	33144	37374	41604	45834
CAM Data[416]	20456	24686	28916	33146	37376	41606	45836
CAM Data[417]	20458	24688	28918	33148	37378	41608	45838
CAM Data[418]	20460	24690	28920	33150	37380	41610	45840
CAM Data[419]	20462	24692	28922	33152	37382	41612	45842
CAM Data[420]	20464	24694	28924	33154	37384	41614	45844
CAM Data[421]	20466	24696	28926	33156	37386	41616	45846
CAM Data[422]	20468	24698	28928	33158	37388	41618	45848
CAM Data[423]	20470	24700	28930	33160	37390	41620	45850
CAM Data[424]	20472	24702	28932	33162	37392	41622	45852
CAM Data[425]	20474	24704	28934	33164	37394	41624	45854
CAM Data[426]	20476	24706	28936	33166	37396	41626	45856
CAM Data[427]	20478	24708	28938	33168	37398	41628	45858
CAM Data[428]	20480	24710	28940	33170	37400	41630	45860
CAM Data[429]	20482	24712	28942	33172	37402	41632	45862
CAM Data[430]	20484	24714	28944	33174	37404	41634	45864
CAM Data[431]	20486	24716	28946	33176	37406	41636	45866
CAM Data[432]	20488	24718	28948	33178	37408	41638	45868
CAM Data[433]	20490	24720	28950	33180	37410	41640	45870
CAM Data[434]	20492	24722	28952	33182	37412	41642	45872
CAM Data[435]	20494	24724	28954	33184	37414	41644	45874
CAM Data[436]	20496	24726	28956	33186	37416	41646	45876
CAM Data[437]	20498	24728	28958	33188	37418	41648	45878
CAM Data[438]	20500	24730	28960	33190	37420	41650	45880
CAM Data[439]	20502	24732	28962	33192	37422	41652	45882
CAM Data[440]	20504	24734	28964	33194	37424	41654	45884
CAM Data[441]	20506	24736	28966	33196	37426	41656	45886

Chapter 10 Internal Memory Address of “Read/Write Variable Data” command

	Block 1	Block 2	Block 3	Block 4	Block 5	Block 6	Block 7
CAM Data[442]	20508	24738	28968	33198	37428	41658	45888
CAM Data[443]	20510	24740	28970	33200	37430	41660	45890
CAM Data[444]	20512	24742	28972	33202	37432	41662	45892
CAM Data[445]	20514	24744	28974	33204	37434	41664	45894
CAM Data[446]	20516	24746	28976	33206	37436	41666	45896
CAM Data[447]	20518	24748	28978	33208	37438	41668	45898
CAM Data[448]	20520	24750	28980	33210	37440	41670	45900
CAM Data[449]	20522	24752	28982	33212	37442	41672	45902
CAM Data[450]	20524	24754	28984	33214	37444	41674	45904
CAM Data[451]	20526	24756	28986	33216	37446	41676	45906
CAM Data[452]	20528	24758	28988	33218	37448	41678	45908
CAM Data[453]	20530	24760	28990	33220	37450	41680	45910
CAM Data[454]	20532	24762	28992	33222	37452	41682	45912
CAM Data[455]	20534	24764	28994	33224	37454	41684	45914
CAM Data[456]	20536	24766	28996	33226	37456	41686	45916
CAM Data[457]	20538	24768	28998	33228	37458	41688	45918
CAM Data[458]	20540	24770	29000	33230	37460	41690	45920
CAM Data[459]	20542	24772	29002	33232	37462	41692	45922
CAM Data[460]	20544	24774	29004	33234	37464	41694	45924
CAM Data[461]	20546	24776	29006	33236	37466	41696	45926
CAM Data[462]	20548	24778	29008	33238	37468	41698	45928
CAM Data[463]	20550	24780	29010	33240	37470	41700	45930
CAM Data[464]	20552	24782	29012	33242	37472	41702	45932
CAM Data[465]	20554	24784	29014	33244	37474	41704	45934
CAM Data[466]	20556	24786	29016	33246	37476	41706	45936
CAM Data[467]	20558	24788	29018	33248	37478	41708	45938
CAM Data[468]	20560	24790	29020	33250	37480	41710	45940
CAM Data[469]	20562	24792	29022	33252	37482	41712	45942
CAM Data[470]	20564	24794	29024	33254	37484	41714	45944
CAM Data[471]	20566	24796	29026	33256	37486	41716	45946
CAM Data[472]	20568	24798	29028	33258	37488	41718	45948
CAM Data[473]	20570	24800	29030	33260	37490	41720	45950
CAM Data[474]	20572	24802	29032	33262	37492	41722	45952
CAM Data[475]	20574	24804	29034	33264	37494	41724	45954
CAM Data[476]	20576	24806	29036	33266	37496	41726	45956
CAM Data[477]	20578	24808	29038	33268	37498	41728	45958
CAM Data[478]	20580	24810	29040	33270	37500	41730	45960
CAM Data[479]	20582	24812	29042	33272	37502	41732	45962
CAM Data[480]	20584	24814	29044	33274	37504	41734	45964
CAM Data[481]	20586	24816	29046	33276	37506	41736	45966
CAM Data[482]	20588	24818	29048	33278	37508	41738	45968
CAM Data[483]	20590	24820	29050	33280	37510	41740	45970
CAM Data[484]	20592	24822	29052	33282	37512	41742	45972

Chapter 10 Internal Memory Address of “Read/Write Variable Data” command

	Block 1	Block 2	Block 3	Block 4	Block 5	Block 6	Block 7
CAM Data[485]	20594	24824	29054	33284	37514	41744	45974
CAM Data[486]	20596	24826	29056	33286	37516	41746	45976
CAM Data[487]	20598	24828	29058	33288	37518	41748	45978
CAM Data[488]	20600	24830	29060	33290	37520	41750	45980
CAM Data[489]	20602	24832	29062	33292	37522	41752	45982
CAM Data[490]	20604	24834	29064	33294	37524	41754	45984
CAM Data[491]	20606	24836	29066	33296	37526	41756	45986
CAM Data[492]	20608	24838	29068	33298	37528	41758	45988
CAM Data[493]	20610	24840	29070	33300	37530	41760	45990
CAM Data[494]	20612	24842	29072	33302	37532	41762	45992
CAM Data[495]	20614	24844	29074	33304	37534	41764	45994
CAM Data[496]	20616	24846	29076	33306	37536	41766	45996
CAM Data[497]	20618	24848	29078	33308	37538	41768	45998
CAM Data[498]	20620	24850	29080	33310	37540	41770	46000
CAM Data[499]	20622	24852	29082	33312	37542	41772	46002
CAM Data[500]	20624	24854	29084	33314	37544	41774	46004
CAM Data[501]	20626	24856	29086	33316	37546	41776	46006
CAM Data[502]	20628	24858	29088	33318	37548	41778	46008
CAM Data[503]	20630	24860	29090	33320	37550	41780	46010
CAM Data[504]	20632	24862	29092	33322	37552	41782	46012
CAM Data[505]	20634	24864	29094	33324	37554	41784	46014
CAM Data[506]	20636	24866	29096	33326	37556	41786	46016
CAM Data[507]	20638	24868	29098	33328	37558	41788	46018
CAM Data[508]	20640	24870	29100	33330	37560	41790	46020
CAM Data[509]	20642	24872	29102	33332	37562	41792	46022
CAM Data[510]	20644	24874	29104	33334	37564	41794	46024
CAM Data[511]	20646	24876	29106	33336	37566	41796	46026
CAM Data[512]	20648	24878	29108	33338	37568	41798	46028
CAM Data[513]	20650	24880	29110	33340	37570	41800	46030
CAM Data[514]	20652	24882	29112	33342	37572	41802	46032
CAM Data[515]	20654	24884	29114	33344	37574	41804	46034
CAM Data[516]	20656	24886	29116	33346	37576	41806	46036
CAM Data[517]	20658	24888	29118	33348	37578	41808	46038
CAM Data[518]	20660	24890	29120	33350	37580	41810	46040
CAM Data[519]	20662	24892	29122	33352	37582	41812	46042
CAM Data[520]	20664	24894	29124	33354	37584	41814	46044
CAM Data[521]	20666	24896	29126	33356	37586	41816	46046
CAM Data[522]	20668	24898	29128	33358	37588	41818	46048
CAM Data[523]	20670	24900	29130	33360	37590	41820	46050
CAM Data[524]	20672	24902	29132	33362	37592	41822	46052
CAM Data[525]	20674	24904	29134	33364	37594	41824	46054
CAM Data[526]	20676	24906	29136	33366	37596	41826	46056
CAM Data[527]	20678	24908	29138	33368	37598	41828	46058

Chapter 10 Internal Memory Address of “Read/Write Variable Data” command

	Block 1	Block 2	Block 3	Block 4	Block 5	Block 6	Block 7
CAM Data[528]	20680	24910	29140	33370	37600	41830	46060
CAM Data[529]	20682	24912	29142	33372	37602	41832	46062
CAM Data[530]	20684	24914	29144	33374	37604	41834	46064
CAM Data[531]	20686	24916	29146	33376	37606	41836	46066
CAM Data[532]	20688	24918	29148	33378	37608	41838	46068
CAM Data[533]	20690	24920	29150	33380	37610	41840	46070
CAM Data[534]	20692	24922	29152	33382	37612	41842	46072
CAM Data[535]	20694	24924	29154	33384	37614	41844	46074
CAM Data[536]	20696	24926	29156	33386	37616	41846	46076
CAM Data[537]	20698	24928	29158	33388	37618	41848	46078
CAM Data[538]	20700	24930	29160	33390	37620	41850	46080
CAM Data[539]	20702	24932	29162	33392	37622	41852	46082
CAM Data[540]	20704	24934	29164	33394	37624	41854	46084
CAM Data[541]	20706	24936	29166	33396	37626	41856	46086
CAM Data[542]	20708	24938	29168	33398	37628	41858	46088
CAM Data[543]	20710	24940	29170	33400	37630	41860	46090
CAM Data[544]	20712	24942	29172	33402	37632	41862	46092
CAM Data[545]	20714	24944	29174	33404	37634	41864	46094
CAM Data[546]	20716	24946	29176	33406	37636	41866	46096
CAM Data[547]	20718	24948	29178	33408	37638	41868	46098
CAM Data[548]	20720	24950	29180	33410	37640	41870	46100
CAM Data[549]	20722	24952	29182	33412	37642	41872	46102
CAM Data[550]	20724	24954	29184	33414	37644	41874	46104
CAM Data[551]	20726	24956	29186	33416	37646	41876	46106
CAM Data[552]	20728	24958	29188	33418	37648	41878	46108
CAM Data[553]	20730	24960	29190	33420	37650	41880	46110
CAM Data[554]	20732	24962	29192	33422	37652	41882	46112
CAM Data[555]	20734	24964	29194	33424	37654	41884	46114
CAM Data[556]	20736	24966	29196	33426	37656	41886	46116
CAM Data[557]	20738	24968	29198	33428	37658	41888	46118
CAM Data[558]	20740	24970	29200	33430	37660	41890	46120
CAM Data[559]	20742	24972	29202	33432	37662	41892	46122
CAM Data[560]	20744	24974	29204	33434	37664	41894	46124
CAM Data[561]	20746	24976	29206	33436	37666	41896	46126
CAM Data[562]	20748	24978	29208	33438	37668	41898	46128
CAM Data[563]	20750	24980	29210	33440	37670	41900	46130
CAM Data[564]	20752	24982	29212	33442	37672	41902	46132
CAM Data[565]	20754	24984	29214	33444	37674	41904	46134
CAM Data[566]	20756	24986	29216	33446	37676	41906	46136
CAM Data[567]	20758	24988	29218	33448	37678	41908	46138
CAM Data[568]	20760	24990	29220	33450	37680	41910	46140
CAM Data[569]	20762	24992	29222	33452	37682	41912	46142
CAM Data[570]	20764	24994	29224	33454	37684	41914	46144

Chapter 10 Internal Memory Address of “Read/Write Variable Data” command

	Block 1	Block 2	Block 3	Block 4	Block 5	Block 6	Block 7
CAM Data[571]	20766	24996	29226	33456	37686	41916	46146
CAM Data[572]	20768	24998	29228	33458	37688	41918	46148
CAM Data[573]	20770	25000	29230	33460	37690	41920	46150
CAM Data[574]	20772	25002	29232	33462	37692	41922	46152
CAM Data[575]	20774	25004	29234	33464	37694	41924	46154
CAM Data[576]	20776	25006	29236	33466	37696	41926	46156
CAM Data[577]	20778	25008	29238	33468	37698	41928	46158
CAM Data[578]	20780	25010	29240	33470	37700	41930	46160
CAM Data[579]	20782	25012	29242	33472	37702	41932	46162
CAM Data[580]	20784	25014	29244	33474	37704	41934	46164
CAM Data[581]	20786	25016	29246	33476	37706	41936	46166
CAM Data[582]	20788	25018	29248	33478	37708	41938	46168
CAM Data[583]	20790	25020	29250	33480	37710	41940	46170
CAM Data[584]	20792	25022	29252	33482	37712	41942	46172
CAM Data[585]	20794	25024	29254	33484	37714	41944	46174
CAM Data[586]	20796	25026	29256	33486	37716	41946	46176
CAM Data[587]	20798	25028	29258	33488	37718	41948	46178
CAM Data[588]	20800	25030	29260	33490	37720	41950	46180
CAM Data[589]	20802	25032	29262	33492	37722	41952	46182
CAM Data[590]	20804	25034	29264	33494	37724	41954	46184
CAM Data[591]	20806	25036	29266	33496	37726	41956	46186
CAM Data[592]	20808	25038	29268	33498	37728	41958	46188
CAM Data[593]	20810	25040	29270	33500	37730	41960	46190
CAM Data[594]	20812	25042	29272	33502	37732	41962	46192
CAM Data[595]	20814	25044	29274	33504	37734	41964	46194
CAM Data[596]	20816	25046	29276	33506	37736	41966	46196
CAM Data[597]	20818	25048	29278	33508	37738	41968	46198
CAM Data[598]	20820	25050	29280	33510	37740	41970	46200
CAM Data[599]	20822	25052	29282	33512	37742	41972	46202
CAM Data[600]	20824	25054	29284	33514	37744	41974	46204
CAM Data[601]	20826	25056	29286	33516	37746	41976	46206
CAM Data[602]	20828	25058	29288	33518	37748	41978	46208
CAM Data[603]	20830	25060	29290	33520	37750	41980	46210
CAM Data[604]	20832	25062	29292	33522	37752	41982	46212
CAM Data[605]	20834	25064	29294	33524	37754	41984	46214
CAM Data[606]	20836	25066	29296	33526	37756	41986	46216
CAM Data[607]	20838	25068	29298	33528	37758	41988	46218
CAM Data[608]	20840	25070	29300	33530	37760	41990	46220
CAM Data[609]	20842	25072	29302	33532	37762	41992	46222
CAM Data[610]	20844	25074	29304	33534	37764	41994	46224
CAM Data[611]	20846	25076	29306	33536	37766	41996	46226
CAM Data[612]	20848	25078	29308	33538	37768	41998	46228
CAM Data[613]	20850	25080	29310	33540	37770	42000	46230

Chapter 10 Internal Memory Address of “Read/Write Variable Data” command

	Block 1	Block 2	Block 3	Block 4	Block 5	Block 6	Block 7
CAM Data[614]	20852	25082	29312	33542	37772	42002	46232
CAM Data[615]	20854	25084	29314	33544	37774	42004	46234
CAM Data[616]	20856	25086	29316	33546	37776	42006	46236
CAM Data[617]	20858	25088	29318	33548	37778	42008	46238
CAM Data[618]	20860	25090	29320	33550	37780	42010	46240
CAM Data[619]	20862	25092	29322	33552	37782	42012	46242
CAM Data[620]	20864	25094	29324	33554	37784	42014	46244
CAM Data[621]	20866	25096	29326	33556	37786	42016	46246
CAM Data[622]	20868	25098	29328	33558	37788	42018	46248
CAM Data[623]	20870	25100	29330	33560	37790	42020	46250
CAM Data[624]	20872	25102	29332	33562	37792	42022	46252
CAM Data[625]	20874	25104	29334	33564	37794	42024	46254
CAM Data[626]	20876	25106	29336	33566	37796	42026	46256
CAM Data[627]	20878	25108	29338	33568	37798	42028	46258
CAM Data[628]	20880	25110	29340	33570	37800	42030	46260
CAM Data[629]	20882	25112	29342	33572	37802	42032	46262
CAM Data[630]	20884	25114	29344	33574	37804	42034	46264
CAM Data[631]	20886	25116	29346	33576	37806	42036	46266
CAM Data[632]	20888	25118	29348	33578	37808	42038	46268
CAM Data[633]	20890	25120	29350	33580	37810	42040	46270
CAM Data[634]	20892	25122	29352	33582	37812	42042	46272
CAM Data[635]	20894	25124	29354	33584	37814	42044	46274
CAM Data[636]	20896	25126	29356	33586	37816	42046	46276
CAM Data[637]	20898	25128	29358	33588	37818	42048	46278
CAM Data[638]	20900	25130	29360	33590	37820	42050	46280
CAM Data[639]	20902	25132	29362	33592	37822	42052	46282
CAM Data[640]	20904	25134	29364	33594	37824	42054	46284
CAM Data[641]	20906	25136	29366	33596	37826	42056	46286
CAM Data[642]	20908	25138	29368	33598	37828	42058	46288
CAM Data[643]	20910	25140	29370	33600	37830	42060	46290
CAM Data[644]	20912	25142	29372	33602	37832	42062	46292
CAM Data[645]	20914	25144	29374	33604	37834	42064	46294
CAM Data[646]	20916	25146	29376	33606	37836	42066	46296
CAM Data[647]	20918	25148	29378	33608	37838	42068	46298
CAM Data[648]	20920	25150	29380	33610	37840	42070	46300
CAM Data[649]	20922	25152	29382	33612	37842	42072	46302
CAM Data[650]	20924	25154	29384	33614	37844	42074	46304
CAM Data[651]	20926	25156	29386	33616	37846	42076	46306
CAM Data[652]	20928	25158	29388	33618	37848	42078	46308
CAM Data[653]	20930	25160	29390	33620	37850	42080	46310
CAM Data[654]	20932	25162	29392	33622	37852	42082	46312
CAM Data[655]	20934	25164	29394	33624	37854	42084	46314
CAM Data[656]	20936	25166	29396	33626	37856	42086	46316

Chapter 10 Internal Memory Address of “Read/Write Variable Data” command

	Block 1	Block 2	Block 3	Block 4	Block 5	Block 6	Block 7
CAM Data[657]	20938	25168	29398	33628	37858	42088	46318
CAM Data[658]	20940	25170	29400	33630	37860	42090	46320
CAM Data[659]	20942	25172	29402	33632	37862	42092	46322
CAM Data[660]	20944	25174	29404	33634	37864	42094	46324
CAM Data[661]	20946	25176	29406	33636	37866	42096	46326
CAM Data[662]	20948	25178	29408	33638	37868	42098	46328
CAM Data[663]	20950	25180	29410	33640	37870	42100	46330
CAM Data[664]	20952	25182	29412	33642	37872	42102	46332
CAM Data[665]	20954	25184	29414	33644	37874	42104	46334
CAM Data[666]	20956	25186	29416	33646	37876	42106	46336
CAM Data[667]	20958	25188	29418	33648	37878	42108	46338
CAM Data[668]	20960	25190	29420	33650	37880	42110	46340
CAM Data[669]	20962	25192	29422	33652	37882	42112	46342
CAM Data[670]	20964	25194	29424	33654	37884	42114	46344
CAM Data[671]	20966	25196	29426	33656	37886	42116	46346
CAM Data[672]	20968	25198	29428	33658	37888	42118	46348
CAM Data[673]	20970	25200	29430	33660	37890	42120	46350
CAM Data[674]	20972	25202	29432	33662	37892	42122	46352
CAM Data[675]	20974	25204	29434	33664	37894	42124	46354
CAM Data[676]	20976	25206	29436	33666	37896	42126	46356
CAM Data[677]	20978	25208	29438	33668	37898	42128	46358
CAM Data[678]	20980	25210	29440	33670	37900	42130	46360
CAM Data[679]	20982	25212	29442	33672	37902	42132	46362
CAM Data[680]	20984	25214	29444	33674	37904	42134	46364
CAM Data[681]	20986	25216	29446	33676	37906	42136	46366
CAM Data[682]	20988	25218	29448	33678	37908	42138	46368
CAM Data[683]	20990	25220	29450	33680	37910	42140	46370
CAM Data[684]	20992	25222	29452	33682	37912	42142	46372
CAM Data[685]	20994	25224	29454	33684	37914	42144	46374
CAM Data[686]	20996	25226	29456	33686	37916	42146	46376
CAM Data[687]	20998	25228	29458	33688	37918	42148	46378
CAM Data[688]	21000	25230	29460	33690	37920	42150	46380
CAM Data[689]	21002	25232	29462	33692	37922	42152	46382
CAM Data[690]	21004	25234	29464	33694	37924	42154	46384
CAM Data[691]	21006	25236	29466	33696	37926	42156	46386
CAM Data[692]	21008	25238	29468	33698	37928	42158	46388
CAM Data[693]	21010	25240	29470	33700	37930	42160	46390
CAM Data[694]	21012	25242	29472	33702	37932	42162	46392
CAM Data[695]	21014	25244	29474	33704	37934	42164	46394
CAM Data[696]	21016	25246	29476	33706	37936	42166	46396
CAM Data[697]	21018	25248	29478	33708	37938	42168	46398
CAM Data[698]	21020	25250	29480	33710	37940	42170	46400
CAM Data[699]	21022	25252	29482	33712	37942	42172	46402

Chapter 10 Internal Memory Address of “Read/Write Variable Data” command

	Block 1	Block 2	Block 3	Block 4	Block 5	Block 6	Block 7
CAM Data[700]	21024	25254	29484	33714	37944	42174	46404
CAM Data[701]	21026	25256	29486	33716	37946	42176	46406
CAM Data[702]	21028	25258	29488	33718	37948	42178	46408
CAM Data[703]	21030	25260	29490	33720	37950	42180	46410
CAM Data[704]	21032	25262	29492	33722	37952	42182	46412
CAM Data[705]	21034	25264	29494	33724	37954	42184	46414
CAM Data[706]	21036	25266	29496	33726	37956	42186	46416
CAM Data[707]	21038	25268	29498	33728	37958	42188	46418
CAM Data[708]	21040	25270	29500	33730	37960	42190	46420
CAM Data[709]	21042	25272	29502	33732	37962	42192	46422
CAM Data[710]	21044	25274	29504	33734	37964	42194	46424
CAM Data[711]	21046	25276	29506	33736	37966	42196	46426
CAM Data[712]	21048	25278	29508	33738	37968	42198	46428
CAM Data[713]	21050	25280	29510	33740	37970	42200	46430
CAM Data[714]	21052	25282	29512	33742	37972	42202	46432
CAM Data[715]	21054	25284	29514	33744	37974	42204	46434
CAM Data[716]	21056	25286	29516	33746	37976	42206	46436
CAM Data[717]	21058	25288	29518	33748	37978	42208	46438
CAM Data[718]	21060	25290	29520	33750	37980	42210	46440
CAM Data[719]	21062	25292	29522	33752	37982	42212	46442
CAM Data[720]	21064	25294	29524	33754	37984	42214	46444
CAM Data[721]	21066	25296	29526	33756	37986	42216	46446
CAM Data[722]	21068	25298	29528	33758	37988	42218	46448
CAM Data[723]	21070	25300	29530	33760	37990	42220	46450
CAM Data[724]	21072	25302	29532	33762	37992	42222	46452
CAM Data[725]	21074	25304	29534	33764	37994	42224	46454
CAM Data[726]	21076	25306	29536	33766	37996	42226	46456
CAM Data[727]	21078	25308	29538	33768	37998	42228	46458
CAM Data[728]	21080	25310	29540	33770	38000	42230	46460
CAM Data[729]	21082	25312	29542	33772	38002	42232	46462
CAM Data[730]	21084	25314	29544	33774	38004	42234	46464
CAM Data[731]	21086	25316	29546	33776	38006	42236	46466
CAM Data[732]	21088	25318	29548	33778	38008	42238	46468
CAM Data[733]	21090	25320	29550	33780	38010	42240	46470
CAM Data[734]	21092	25322	29552	33782	38012	42242	46472
CAM Data[735]	21094	25324	29554	33784	38014	42244	46474
CAM Data[736]	21096	25326	29556	33786	38016	42246	46476
CAM Data[737]	21098	25328	29558	33788	38018	42248	46478
CAM Data[738]	21100	25330	29560	33790	38020	42250	46480
CAM Data[739]	21102	25332	29562	33792	38022	42252	46482
CAM Data[740]	21104	25334	29564	33794	38024	42254	46484
CAM Data[741]	21106	25336	29566	33796	38026	42256	46486
CAM Data[742]	21108	25338	29568	33798	38028	42258	46488

Chapter 10 Internal Memory Address of “Read/Write Variable Data” command

	Block 1	Block 2	Block 3	Block 4	Block 5	Block 6	Block 7
CAM Data[743]	21110	25340	29570	33800	38030	42260	46490
CAM Data[744]	21112	25342	29572	33802	38032	42262	46492
CAM Data[745]	21114	25344	29574	33804	38034	42264	46494
CAM Data[746]	21116	25346	29576	33806	38036	42266	46496
CAM Data[747]	21118	25348	29578	33808	38038	42268	46498
CAM Data[748]	21120	25350	29580	33810	38040	42270	46500
CAM Data[749]	21122	25352	29582	33812	38042	42272	46502
CAM Data[750]	21124	25354	29584	33814	38044	42274	46504
CAM Data[751]	21126	25356	29586	33816	38046	42276	46506
CAM Data[752]	21128	25358	29588	33818	38048	42278	46508
CAM Data[753]	21130	25360	29590	33820	38050	42280	46510
CAM Data[754]	21132	25362	29592	33822	38052	42282	46512
CAM Data[755]	21134	25364	29594	33824	38054	42284	46514
CAM Data[756]	21136	25366	29596	33826	38056	42286	46516
CAM Data[757]	21138	25368	29598	33828	38058	42288	46518
CAM Data[758]	21140	25370	29600	33830	38060	42290	46520
CAM Data[759]	21142	25372	29602	33832	38062	42292	46522
CAM Data[760]	21144	25374	29604	33834	38064	42294	46524
CAM Data[761]	21146	25376	29606	33836	38066	42296	46526
CAM Data[762]	21148	25378	29608	33838	38068	42298	46528
CAM Data[763]	21150	25380	29610	33840	38070	42300	46530
CAM Data[764]	21152	25382	29612	33842	38072	42302	46532
CAM Data[765]	21154	25384	29614	33844	38074	42304	46534
CAM Data[766]	21156	25386	29616	33846	38076	42306	46536
CAM Data[767]	21158	25388	29618	33848	38078	42308	46538
CAM Data[768]	21160	25390	29620	33850	38080	42310	46540
CAM Data[769]	21162	25392	29622	33852	38082	42312	46542
CAM Data[770]	21164	25394	29624	33854	38084	42314	46544
CAM Data[771]	21166	25396	29626	33856	38086	42316	46546
CAM Data[772]	21168	25398	29628	33858	38088	42318	46548
CAM Data[773]	21170	25400	29630	33860	38090	42320	46550
CAM Data[774]	21172	25402	29632	33862	38092	42322	46552
CAM Data[775]	21174	25404	29634	33864	38094	42324	46554
CAM Data[776]	21176	25406	29636	33866	38096	42326	46556
CAM Data[777]	21178	25408	29638	33868	38098	42328	46558
CAM Data[778]	21180	25410	29640	33870	38100	42330	46560
CAM Data[779]	21182	25412	29642	33872	38102	42332	46562
CAM Data[780]	21184	25414	29644	33874	38104	42334	46564
CAM Data[781]	21186	25416	29646	33876	38106	42336	46566
CAM Data[782]	21188	25418	29648	33878	38108	42338	46568
CAM Data[783]	21190	25420	29650	33880	38110	42340	46570
CAM Data[784]	21192	25422	29652	33882	38112	42342	46572
CAM Data[785]	21194	25424	29654	33884	38114	42344	46574

Chapter 10 Internal Memory Address of “Read/Write Variable Data” command

	Block 1	Block 2	Block 3	Block 4	Block 5	Block 6	Block 7
CAM Data[786]	21196	25426	29656	33886	38116	42346	46576
CAM Data[787]	21198	25428	29658	33888	38118	42348	46578
CAM Data[788]	21200	25430	29660	33890	38120	42350	46580
CAM Data[789]	21202	25432	29662	33892	38122	42352	46582
CAM Data[790]	21204	25434	29664	33894	38124	42354	46584
CAM Data[791]	21206	25436	29666	33896	38126	42356	46586
CAM Data[792]	21208	25438	29668	33898	38128	42358	46588
CAM Data[793]	21210	25440	29670	33900	38130	42360	46590
CAM Data[794]	21212	25442	29672	33902	38132	42362	46592
CAM Data[795]	21214	25444	29674	33904	38134	42364	46594
CAM Data[796]	21216	25446	29676	33906	38136	42366	46596
CAM Data[797]	21218	25448	29678	33908	38138	42368	46598
CAM Data[798]	21220	25450	29680	33910	38140	42370	46600
CAM Data[799]	21222	25452	29682	33912	38142	42372	46602
CAM Data[800]	21224	25454	29684	33914	38144	42374	46604
CAM Data[801]	21226	25456	29686	33916	38146	42376	46606
CAM Data[802]	21228	25458	29688	33918	38148	42378	46608
CAM Data[803]	21230	25460	29690	33920	38150	42380	46610
CAM Data[804]	21232	25462	29692	33922	38152	42382	46612
CAM Data[805]	21234	25464	29694	33924	38154	42384	46614
CAM Data[806]	21236	25466	29696	33926	38156	42386	46616
CAM Data[807]	21238	25468	29698	33928	38158	42388	46618
CAM Data[808]	21240	25470	29700	33930	38160	42390	46620
CAM Data[809]	21242	25472	29702	33932	38162	42392	46622
CAM Data[810]	21244	25474	29704	33934	38164	42394	46624
CAM Data[811]	21246	25476	29706	33936	38166	42396	46626
CAM Data[812]	21248	25478	29708	33938	38168	42398	46628
CAM Data[813]	21250	25480	29710	33940	38170	42400	46630
CAM Data[814]	21252	25482	29712	33942	38172	42402	46632
CAM Data[815]	21254	25484	29714	33944	38174	42404	46634
CAM Data[816]	21256	25486	29716	33946	38176	42406	46636
CAM Data[817]	21258	25488	29718	33948	38178	42408	46638
CAM Data[818]	21260	25490	29720	33950	38180	42410	46640
CAM Data[819]	21262	25492	29722	33952	38182	42412	46642
CAM Data[820]	21264	25494	29724	33954	38184	42414	46644
CAM Data[821]	21266	25496	29726	33956	38186	42416	46646
CAM Data[822]	21268	25498	29728	33958	38188	42418	46648
CAM Data[823]	21270	25500	29730	33960	38190	42420	46650
CAM Data[824]	21272	25502	29732	33962	38192	42422	46652
CAM Data[825]	21274	25504	29734	33964	38194	42424	46654
CAM Data[826]	21276	25506	29736	33966	38196	42426	46656
CAM Data[827]	21278	25508	29738	33968	38198	42428	46658
CAM Data[828]	21280	25510	29740	33970	38200	42430	46660

Chapter 10 Internal Memory Address of “Read/Write Variable Data” command

	Block 1	Block 2	Block 3	Block 4	Block 5	Block 6	Block 7
CAM Data[829]	21282	25512	29742	33972	38202	42432	46662
CAM Data[830]	21284	25514	29744	33974	38204	42434	46664
CAM Data[831]	21286	25516	29746	33976	38206	42436	46666
CAM Data[832]	21288	25518	29748	33978	38208	42438	46668
CAM Data[833]	21290	25520	29750	33980	38210	42440	46670
CAM Data[834]	21292	25522	29752	33982	38212	42442	46672
CAM Data[835]	21294	25524	29754	33984	38214	42444	46674
CAM Data[836]	21296	25526	29756	33986	38216	42446	46676
CAM Data[837]	21298	25528	29758	33988	38218	42448	46678
CAM Data[838]	21300	25530	29760	33990	38220	42450	46680
CAM Data[839]	21302	25532	29762	33992	38222	42452	46682
CAM Data[840]	21304	25534	29764	33994	38224	42454	46684
CAM Data[841]	21306	25536	29766	33996	38226	42456	46686
CAM Data[842]	21308	25538	29768	33998	38228	42458	46688
CAM Data[843]	21310	25540	29770	34000	38230	42460	46690
CAM Data[844]	21312	25542	29772	34002	38232	42462	46692
CAM Data[845]	21314	25544	29774	34004	38234	42464	46694
CAM Data[846]	21316	25546	29776	34006	38236	42466	46696
CAM Data[847]	21318	25548	29778	34008	38238	42468	46698
CAM Data[848]	21320	25550	29780	34010	38240	42470	46700
CAM Data[849]	21322	25552	29782	34012	38242	42472	46702
CAM Data[850]	21324	25554	29784	34014	38244	42474	46704
CAM Data[851]	21326	25556	29786	34016	38246	42476	46706
CAM Data[852]	21328	25558	29788	34018	38248	42478	46708
CAM Data[853]	21330	25560	29790	34020	38250	42480	46710
CAM Data[854]	21332	25562	29792	34022	38252	42482	46712
CAM Data[855]	21334	25564	29794	34024	38254	42484	46714
CAM Data[856]	21336	25566	29796	34026	38256	42486	46716
CAM Data[857]	21338	25568	29798	34028	38258	42488	46718
CAM Data[858]	21340	25570	29800	34030	38260	42490	46720
CAM Data[859]	21342	25572	29802	34032	38262	42492	46722
CAM Data[860]	21344	25574	29804	34034	38264	42494	46724
CAM Data[861]	21346	25576	29806	34036	38266	42496	46726
CAM Data[862]	21348	25578	29808	34038	38268	42498	46728
CAM Data[863]	21350	25580	29810	34040	38270	42500	46730
CAM Data[864]	21352	25582	29812	34042	38272	42502	46732
CAM Data[865]	21354	25584	29814	34044	38274	42504	46734
CAM Data[866]	21356	25586	29816	34046	38276	42506	46736
CAM Data[867]	21358	25588	29818	34048	38278	42508	46738
CAM Data[868]	21360	25590	29820	34050	38280	42510	46740
CAM Data[869]	21362	25592	29822	34052	38282	42512	46742
CAM Data[870]	21364	25594	29824	34054	38284	42514	46744
CAM Data[871]	21366	25596	29826	34056	38286	42516	46746

Chapter 10 Internal Memory Address of “Read/Write Variable Data” command

	Block 1	Block 2	Block 3	Block 4	Block 5	Block 6	Block 7
CAM Data[872]	21368	25598	29828	34058	38288	42518	46748
CAM Data[873]	21370	25600	29830	34060	38290	42520	46750
CAM Data[874]	21372	25602	29832	34062	38292	42522	46752
CAM Data[875]	21374	25604	29834	34064	38294	42524	46754
CAM Data[876]	21376	25606	29836	34066	38296	42526	46756
CAM Data[877]	21378	25608	29838	34068	38298	42528	46758
CAM Data[878]	21380	25610	29840	34070	38300	42530	46760
CAM Data[879]	21382	25612	29842	34072	38302	42532	46762
CAM Data[880]	21384	25614	29844	34074	38304	42534	46764
CAM Data[881]	21386	25616	29846	34076	38306	42536	46766
CAM Data[882]	21388	25618	29848	34078	38308	42538	46768
CAM Data[883]	21390	25620	29850	34080	38310	42540	46770
CAM Data[884]	21392	25622	29852	34082	38312	42542	46772
CAM Data[885]	21394	25624	29854	34084	38314	42544	46774
CAM Data[886]	21396	25626	29856	34086	38316	42546	46776
CAM Data[887]	21398	25628	29858	34088	38318	42548	46778
CAM Data[888]	21400	25630	29860	34090	38320	42550	46780
CAM Data[889]	21402	25632	29862	34092	38322	42552	46782
CAM Data[890]	21404	25634	29864	34094	38324	42554	46784
CAM Data[891]	21406	25636	29866	34096	38326	42556	46786
CAM Data[892]	21408	25638	29868	34098	38328	42558	46788
CAM Data[893]	21410	25640	29870	34100	38330	42560	46790
CAM Data[894]	21412	25642	29872	34102	38332	42562	46792
CAM Data[895]	21414	25644	29874	34104	38334	42564	46794
CAM Data[896]	21416	25646	29876	34106	38336	42566	46796
CAM Data[897]	21418	25648	29878	34108	38338	42568	46798
CAM Data[898]	21420	25650	29880	34110	38340	42570	46800
CAM Data[899]	21422	25652	29882	34112	38342	42572	46802
CAM Data[900]	21424	25654	29884	34114	38344	42574	46804
CAM Data[901]	21426	25656	29886	34116	38346	42576	46806
CAM Data[902]	21428	25658	29888	34118	38348	42578	46808
CAM Data[903]	21430	25660	29890	34120	38350	42580	46810
CAM Data[904]	21432	25662	29892	34122	38352	42582	46812
CAM Data[905]	21434	25664	29894	34124	38354	42584	46814
CAM Data[906]	21436	25666	29896	34126	38356	42586	46816
CAM Data[907]	21438	25668	29898	34128	38358	42588	46818
CAM Data[908]	21440	25670	29900	34130	38360	42590	46820
CAM Data[909]	21442	25672	29902	34132	38362	42592	46822
CAM Data[910]	21444	25674	29904	34134	38364	42594	46824
CAM Data[911]	21446	25676	29906	34136	38366	42596	46826
CAM Data[912]	21448	25678	29908	34138	38368	42598	46828
CAM Data[913]	21450	25680	29910	34140	38370	42600	46830
CAM Data[914]	21452	25682	29912	34142	38372	42602	46832

Chapter 10 Internal Memory Address of “Read/Write Variable Data” command

	Block 1	Block 2	Block 3	Block 4	Block 5	Block 6	Block 7
CAM Data[915]	21454	25684	29914	34144	38374	42604	46834
CAM Data[916]	21456	25686	29916	34146	38376	42606	46836
CAM Data[917]	21458	25688	29918	34148	38378	42608	46838
CAM Data[918]	21460	25690	29920	34150	38380	42610	46840
CAM Data[919]	21462	25692	29922	34152	38382	42612	46842
CAM Data[920]	21464	25694	29924	34154	38384	42614	46844
CAM Data[921]	21466	25696	29926	34156	38386	42616	46846
CAM Data[922]	21468	25698	29928	34158	38388	42618	46848
CAM Data[923]	21470	25700	29930	34160	38390	42620	46850
CAM Data[924]	21472	25702	29932	34162	38392	42622	46852
CAM Data[925]	21474	25704	29934	34164	38394	42624	46854
CAM Data[926]	21476	25706	29936	34166	38396	42626	46856
CAM Data[927]	21478	25708	29938	34168	38398	42628	46858
CAM Data[928]	21480	25710	29940	34170	38400	42630	46860
CAM Data[929]	21482	25712	29942	34172	38402	42632	46862
CAM Data[930]	21484	25714	29944	34174	38404	42634	46864
CAM Data[931]	21486	25716	29946	34176	38406	42636	46866
CAM Data[932]	21488	25718	29948	34178	38408	42638	46868
CAM Data[933]	21490	25720	29950	34180	38410	42640	46870
CAM Data[934]	21492	25722	29952	34182	38412	42642	46872
CAM Data[935]	21494	25724	29954	34184	38414	42644	46874
CAM Data[936]	21496	25726	29956	34186	38416	42646	46876
CAM Data[937]	21498	25728	29958	34188	38418	42648	46878
CAM Data[938]	21500	25730	29960	34190	38420	42650	46880
CAM Data[939]	21502	25732	29962	34192	38422	42652	46882
CAM Data[940]	21504	25734	29964	34194	38424	42654	46884
CAM Data[941]	21506	25736	29966	34196	38426	42656	46886
CAM Data[942]	21508	25738	29968	34198	38428	42658	46888
CAM Data[943]	21510	25740	29970	34200	38430	42660	46890
CAM Data[944]	21512	25742	29972	34202	38432	42662	46892
CAM Data[945]	21514	25744	29974	34204	38434	42664	46894
CAM Data[946]	21516	25746	29976	34206	38436	42666	46896
CAM Data[947]	21518	25748	29978	34208	38438	42668	46898
CAM Data[948]	21520	25750	29980	34210	38440	42670	46900
CAM Data[949]	21522	25752	29982	34212	38442	42672	46902
CAM Data[950]	21524	25754	29984	34214	38444	42674	46904
CAM Data[951]	21526	25756	29986	34216	38446	42676	46906
CAM Data[952]	21528	25758	29988	34218	38448	42678	46908
CAM Data[953]	21530	25760	29990	34220	38450	42680	46910
CAM Data[954]	21532	25762	29992	34222	38452	42682	46912
CAM Data[955]	21534	25764	29994	34224	38454	42684	46914
CAM Data[956]	21536	25766	29996	34226	38456	42686	46916
CAM Data[957]	21538	25768	29998	34228	38458	42688	46918

Chapter 10 Internal Memory Address of “Read/Write Variable Data” command

	Block 1	Block 2	Block 3	Block 4	Block 5	Block 6	Block 7
CAM Data[958]	21540	25770	30000	34230	38460	42690	46920
CAM Data[959]	21542	25772	30002	34232	38462	42692	46922
CAM Data[960]	21544	25774	30004	34234	38464	42694	46924
CAM Data[961]	21546	25776	30006	34236	38466	42696	46926
CAM Data[962]	21548	25778	30008	34238	38468	42698	46928
CAM Data[963]	21550	25780	30010	34240	38470	42700	46930
CAM Data[964]	21552	25782	30012	34242	38472	42702	46932
CAM Data[965]	21554	25784	30014	34244	38474	42704	46934
CAM Data[966]	21556	25786	30016	34246	38476	42706	46936
CAM Data[967]	21558	25788	30018	34248	38478	42708	46938
CAM Data[968]	21560	25790	30020	34250	38480	42710	46940
CAM Data[969]	21562	25792	30022	34252	38482	42712	46942
CAM Data[970]	21564	25794	30024	34254	38484	42714	46944
CAM Data[971]	21566	25796	30026	34256	38486	42716	46946
CAM Data[972]	21568	25798	30028	34258	38488	42718	46948
CAM Data[973]	21570	25800	30030	34260	38490	42720	46950
CAM Data[974]	21572	25802	30032	34262	38492	42722	46952
CAM Data[975]	21574	25804	30034	34264	38494	42724	46954
CAM Data[976]	21576	25806	30036	34266	38496	42726	46956
CAM Data[977]	21578	25808	30038	34268	38498	42728	46958
CAM Data[978]	21580	25810	30040	34270	38500	42730	46960
CAM Data[979]	21582	25812	30042	34272	38502	42732	46962
CAM Data[980]	21584	25814	30044	34274	38504	42734	46964
CAM Data[981]	21586	25816	30046	34276	38506	42736	46966
CAM Data[982]	21588	25818	30048	34278	38508	42738	46968
CAM Data[983]	21590	25820	30050	34280	38510	42740	46970
CAM Data[984]	21592	25822	30052	34282	38512	42742	46972
CAM Data[985]	21594	25824	30054	34284	38514	42744	46974
CAM Data[986]	21596	25826	30056	34286	38516	42746	46976
CAM Data[987]	21598	25828	30058	34288	38518	42748	46978
CAM Data[988]	21600	25830	30060	34290	38520	42750	46980
CAM Data[989]	21602	25832	30062	34292	38522	42752	46982
CAM Data[990]	21604	25834	30064	34294	38524	42754	46984
CAM Data[991]	21606	25836	30066	34296	38526	42756	46986
CAM Data[992]	21608	25838	30068	34298	38528	42758	46988
CAM Data[993]	21610	25840	30070	34300	38530	42760	46990
CAM Data[994]	21612	25842	30072	34302	38532	42762	46992
CAM Data[995]	21614	25844	30074	34304	38534	42764	46994
CAM Data[996]	21616	25846	30076	34306	38536	42766	46996
CAM Data[997]	21618	25848	30078	34308	38538	42768	46998
CAM Data[998]	21620	25850	30080	34310	38540	42770	47000
CAM Data[999]	21622	25852	30082	34312	38542	42772	47002
CAM Data[1000]	21624	25854	30084	34314	38544	42774	47004

Chapter 10 Internal Memory Address of “Read/Write Variable Data” command

	Block 1	Block 2	Block 3	Block 4	Block 5	Block 6	Block 7
CAM Data[1001]	21626	25856	30086	34316	38546	42776	47006
CAM Data[1002]	21628	25858	30088	34318	38548	42778	47008
CAM Data[1003]	21630	25860	30090	34320	38550	42780	47010
CAM Data[1004]	21632	25862	30092	34322	38552	42782	47012
CAM Data[1005]	21634	25864	30094	34324	38554	42784	47014
CAM Data[1006]	21636	25866	30096	34326	38556	42786	47016
CAM Data[1007]	21638	25868	30098	34328	38558	42788	47018
CAM Data[1008]	21640	25870	30100	34330	38560	42790	47020
CAM Data[1009]	21642	25872	30102	34332	38562	42792	47022
CAM Data[1010]	21644	25874	30104	34334	38564	42794	47024
CAM Data[1011]	21646	25876	30106	34336	38566	42796	47026
CAM Data[1012]	21648	25878	30108	34338	38568	42798	47028
CAM Data[1013]	21650	25880	30110	34340	38570	42800	47030
CAM Data[1014]	21652	25882	30112	34342	38572	42802	47032
CAM Data[1015]	21654	25884	30114	34344	38574	42804	47034
CAM Data[1016]	21656	25886	30116	34346	38576	42806	47036
CAM Data[1017]	21658	25888	30118	34348	38578	42808	47038
CAM Data[1018]	21660	25890	30120	34350	38580	42810	47040
CAM Data[1019]	21662	25892	30122	34352	38582	42812	47042
CAM Data[1020]	21664	25894	30124	34354	38584	42814	47044
CAM Data[1021]	21666	25896	30126	34356	38586	42816	47046
CAM Data[1022]	21668	25898	30128	34358	38588	42818	47048
CAM Data[1023]	21670	25900	30130	34360	38590	42820	47050
CAM Data[1024]	21672	25902	30132	34362	38592	42822	47052
CAM Data[1025]	21674	25904	30134	34364	38594	42824	47054
CAM Data[1026]	21676	25906	30136	34366	38596	42826	47056
CAM Data[1027]	21678	25908	30138	34368	38598	42828	47058
CAM Data[1028]	21680	25910	30140	34370	38600	42830	47060
CAM Data[1029]	21682	25912	30142	34372	38602	42832	47062
CAM Data[1030]	21684	25914	30144	34374	38604	42834	47064
CAM Data[1031]	21686	25916	30146	34376	38606	42836	47066
CAM Data[1032]	21688	25918	30148	34378	38608	42838	47068
CAM Data[1033]	21690	25920	30150	34380	38610	42840	47070
CAM Data[1034]	21692	25922	30152	34382	38612	42842	47072
CAM Data[1035]	21694	25924	30154	34384	38614	42844	47074
CAM Data[1036]	21696	25926	30156	34386	38616	42846	47076
CAM Data[1037]	21698	25928	30158	34388	38618	42848	47078
CAM Data[1038]	21700	25930	30160	34390	38620	42850	47080
CAM Data[1039]	21702	25932	30162	34392	38622	42852	47082
CAM Data[1040]	21704	25934	30164	34394	38624	42854	47084
CAM Data[1041]	21706	25936	30166	34396	38626	42856	47086
CAM Data[1042]	21708	25938	30168	34398	38628	42858	47088
CAM Data[1043]	21710	25940	30170	34400	38630	42860	47090

Chapter 10 Internal Memory Address of “Read/Write Variable Data” command

	Block 1	Block 2	Block 3	Block 4	Block 5	Block 6	Block 7
CAM Data[1044]	21712	25942	30172	34402	38632	42862	47092
CAM Data[1045]	21714	25944	30174	34404	38634	42864	47094
CAM Data[1046]	21716	25946	30176	34406	38636	42866	47096
CAM Data[1047]	21718	25948	30178	34408	38638	42868	47098
CAM Data[1048]	21720	25950	30180	34410	38640	42870	47100
CAM Data[1049]	21722	25952	30182	34412	38642	42872	47102
CAM Data[1050]	21724	25954	30184	34414	38644	42874	47104
CAM Data[1051]	21726	25956	30186	34416	38646	42876	47106
CAM Data[1052]	21728	25958	30188	34418	38648	42878	47108
CAM Data[1053]	21730	25960	30190	34420	38650	42880	47110
CAM Data[1054]	21732	25962	30192	34422	38652	42882	47112
CAM Data[1055]	21734	25964	30194	34424	38654	42884	47114
CAM Data[1056]	21736	25966	30196	34426	38656	42886	47116
CAM Data[1057]	21738	25968	30198	34428	38658	42888	47118
CAM Data[1058]	21740	25970	30200	34430	38660	42890	47120
CAM Data[1059]	21742	25972	30202	34432	38662	42892	47122
CAM Data[1060]	21744	25974	30204	34434	38664	42894	47124
CAM Data[1061]	21746	25976	30206	34436	38666	42896	47126
CAM Data[1062]	21748	25978	30208	34438	38668	42898	47128
CAM Data[1063]	21750	25980	30210	34440	38670	42900	47130
CAM Data[1064]	21752	25982	30212	34442	38672	42902	47132
CAM Data[1065]	21754	25984	30214	34444	38674	42904	47134
CAM Data[1066]	21756	25986	30216	34446	38676	42906	47136
CAM Data[1067]	21758	25988	30218	34448	38678	42908	47138
CAM Data[1068]	21760	25990	30220	34450	38680	42910	47140
CAM Data[1069]	21762	25992	30222	34452	38682	42912	47142
CAM Data[1070]	21764	25994	30224	34454	38684	42914	47144
CAM Data[1071]	21766	25996	30226	34456	38686	42916	47146
CAM Data[1072]	21768	25998	30228	34458	38688	42918	47148
CAM Data[1073]	21770	26000	30230	34460	38690	42920	47150
CAM Data[1074]	21772	26002	30232	34462	38692	42922	47152
CAM Data[1075]	21774	26004	30234	34464	38694	42924	47154
CAM Data[1076]	21776	26006	30236	34466	38696	42926	47156
CAM Data[1077]	21778	26008	30238	34468	38698	42928	47158
CAM Data[1078]	21780	26010	30240	34470	38700	42930	47160
CAM Data[1079]	21782	26012	30242	34472	38702	42932	47162
CAM Data[1080]	21784	26014	30244	34474	38704	42934	47164
CAM Data[1081]	21786	26016	30246	34476	38706	42936	47166
CAM Data[1082]	21788	26018	30248	34478	38708	42938	47168
CAM Data[1083]	21790	26020	30250	34480	38710	42940	47170
CAM Data[1084]	21792	26022	30252	34482	38712	42942	47172
CAM Data[1085]	21794	26024	30254	34484	38714	42944	47174
CAM Data[1086]	21796	26026	30256	34486	38716	42946	47176

Chapter 10 Internal Memory Address of “Read/Write Variable Data” command

	Block 1	Block 2	Block 3	Block 4	Block 5	Block 6	Block 7
CAM Data[1087]	21798	26028	30258	34488	38718	42948	47178
CAM Data[1088]	21800	26030	30260	34490	38720	42950	47180
CAM Data[1089]	21802	26032	30262	34492	38722	42952	47182
CAM Data[1090]	21804	26034	30264	34494	38724	42954	47184
CAM Data[1091]	21806	26036	30266	34496	38726	42956	47186
CAM Data[1092]	21808	26038	30268	34498	38728	42958	47188
CAM Data[1093]	21810	26040	30270	34500	38730	42960	47190
CAM Data[1094]	21812	26042	30272	34502	38732	42962	47192
CAM Data[1095]	21814	26044	30274	34504	38734	42964	47194
CAM Data[1096]	21816	26046	30276	34506	38736	42966	47196
CAM Data[1097]	21818	26048	30278	34508	38738	42968	47198
CAM Data[1098]	21820	26050	30280	34510	38740	42970	47200
CAM Data[1099]	21822	26052	30282	34512	38742	42972	47202
CAM Data[1100]	21824	26054	30284	34514	38744	42974	47204
CAM Data[1101]	21826	26056	30286	34516	38746	42976	47206
CAM Data[1102]	21828	26058	30288	34518	38748	42978	47208
CAM Data[1103]	21830	26060	30290	34520	38750	42980	47210
CAM Data[1104]	21832	26062	30292	34522	38752	42982	47212
CAM Data[1105]	21834	26064	30294	34524	38754	42984	47214
CAM Data[1106]	21836	26066	30296	34526	38756	42986	47216
CAM Data[1107]	21838	26068	30298	34528	38758	42988	47218
CAM Data[1108]	21840	26070	30300	34530	38760	42990	47220
CAM Data[1109]	21842	26072	30302	34532	38762	42992	47222
CAM Data[1110]	21844	26074	30304	34534	38764	42994	47224
CAM Data[1111]	21846	26076	30306	34536	38766	42996	47226
CAM Data[1112]	21848	26078	30308	34538	38768	42998	47228
CAM Data[1113]	21850	26080	30310	34540	38770	43000	47230
CAM Data[1114]	21852	26082	30312	34542	38772	43002	47232
CAM Data[1115]	21854	26084	30314	34544	38774	43004	47234
CAM Data[1116]	21856	26086	30316	34546	38776	43006	47236
CAM Data[1117]	21858	26088	30318	34548	38778	43008	47238
CAM Data[1118]	21860	26090	30320	34550	38780	43010	47240
CAM Data[1119]	21862	26092	30322	34552	38782	43012	47242
CAM Data[1120]	21864	26094	30324	34554	38784	43014	47244
CAM Data[1121]	21866	26096	30326	34556	38786	43016	47246
CAM Data[1122]	21868	26098	30328	34558	38788	43018	47248
CAM Data[1123]	21870	26100	30330	34560	38790	43020	47250
CAM Data[1124]	21872	26102	30332	34562	38792	43022	47252
CAM Data[1125]	21874	26104	30334	34564	38794	43024	47254
CAM Data[1126]	21876	26106	30336	34566	38796	43026	47256
CAM Data[1127]	21878	26108	30338	34568	38798	43028	47258
CAM Data[1128]	21880	26110	30340	34570	38800	43030	47260
CAM Data[1129]	21882	26112	30342	34572	38802	43032	47262

Chapter 10 Internal Memory Address of “Read/Write Variable Data” command

	Block 1	Block 2	Block 3	Block 4	Block 5	Block 6	Block 7
CAM Data[1130]	21884	26114	30344	34574	38804	43034	47264
CAM Data[1131]	21886	26116	30346	34576	38806	43036	47266
CAM Data[1132]	21888	26118	30348	34578	38808	43038	47268
CAM Data[1133]	21890	26120	30350	34580	38810	43040	47270
CAM Data[1134]	21892	26122	30352	34582	38812	43042	47272
CAM Data[1135]	21894	26124	30354	34584	38814	43044	47274
CAM Data[1136]	21896	26126	30356	34586	38816	43046	47276
CAM Data[1137]	21898	26128	30358	34588	38818	43048	47278
CAM Data[1138]	21900	26130	30360	34590	38820	43050	47280
CAM Data[1139]	21902	26132	30362	34592	38822	43052	47282
CAM Data[1140]	21904	26134	30364	34594	38824	43054	47284
CAM Data[1141]	21906	26136	30366	34596	38826	43056	47286
CAM Data[1142]	21908	26138	30368	34598	38828	43058	47288
CAM Data[1143]	21910	26140	30370	34600	38830	43060	47290
CAM Data[1144]	21912	26142	30372	34602	38832	43062	47292
CAM Data[1145]	21914	26144	30374	34604	38834	43064	47294
CAM Data[1146]	21916	26146	30376	34606	38836	43066	47296
CAM Data[1147]	21918	26148	30378	34608	38838	43068	47298
CAM Data[1148]	21920	26150	30380	34610	38840	43070	47300
CAM Data[1149]	21922	26152	30382	34612	38842	43072	47302
CAM Data[1150]	21924	26154	30384	34614	38844	43074	47304
CAM Data[1151]	21926	26156	30386	34616	38846	43076	47306
CAM Data[1152]	21928	26158	30388	34618	38848	43078	47308
CAM Data[1153]	21930	26160	30390	34620	38850	43080	47310
CAM Data[1154]	21932	26162	30392	34622	38852	43082	47312
CAM Data[1155]	21934	26164	30394	34624	38854	43084	47314
CAM Data[1156]	21936	26166	30396	34626	38856	43086	47316
CAM Data[1157]	21938	26168	30398	34628	38858	43088	47318
CAM Data[1158]	21940	26170	30400	34630	38860	43090	47320
CAM Data[1159]	21942	26172	30402	34632	38862	43092	47322
CAM Data[1160]	21944	26174	30404	34634	38864	43094	47324
CAM Data[1161]	21946	26176	30406	34636	38866	43096	47326
CAM Data[1162]	21948	26178	30408	34638	38868	43098	47328
CAM Data[1163]	21950	26180	30410	34640	38870	43100	47330
CAM Data[1164]	21952	26182	30412	34642	38872	43102	47332
CAM Data[1165]	21954	26184	30414	34644	38874	43104	47334
CAM Data[1166]	21956	26186	30416	34646	38876	43106	47336
CAM Data[1167]	21958	26188	30418	34648	38878	43108	47338
CAM Data[1168]	21960	26190	30420	34650	38880	43110	47340
CAM Data[1169]	21962	26192	30422	34652	38882	43112	47342
CAM Data[1170]	21964	26194	30424	34654	38884	43114	47344
CAM Data[1171]	21966	26196	30426	34656	38886	43116	47346
CAM Data[1172]	21968	26198	30428	34658	38888	43118	47348
CAM Data[1173]	21970	26200	30430	34660	38890	43120	47350

Chapter 10 Internal Memory Address of “Read/Write Variable Data” command

	Block 1	Block 2	Block 3	Block 4	Block 5	Block 6	Block 7
CAM Data[1174]	21972	26202	30432	34662	38892	43122	47352
CAM Data[1175]	21974	26204	30434	34664	38894	43124	47354
CAM Data[1176]	21976	26206	30436	34666	38896	43126	47356
CAM Data[1177]	21978	26208	30438	34668	38898	43128	47358
CAM Data[1178]	21980	26210	30440	34670	38900	43130	47360
CAM Data[1179]	21982	26212	30442	34672	38902	43132	47362
CAM Data[1180]	21984	26214	30444	34674	38904	43134	47364
CAM Data[1181]	21986	26216	30446	34676	38906	43136	47366
CAM Data[1182]	21988	26218	30448	34678	38908	43138	47368
CAM Data[1183]	21990	26220	30450	34680	38910	43140	47370
CAM Data[1184]	21992	26222	30452	34682	38912	43142	47372
CAM Data[1185]	21994	26224	30454	34684	38914	43144	47374
CAM Data[1186]	21996	26226	30456	34686	38916	43146	47376
CAM Data[1187]	21998	26228	30458	34688	38918	43148	47378
CAM Data[1188]	22000	26230	30460	34690	38920	43150	47380
CAM Data[1189]	22002	26232	30462	34692	38922	43152	47382
CAM Data[1190]	22004	26234	30464	34694	38924	43154	47384
CAM Data[1191]	22006	26236	30466	34696	38926	43156	47386
CAM Data[1192]	22008	26238	30468	34698	38928	43158	47388
CAM Data[1193]	22010	26240	30470	34700	38930	43160	47390
CAM Data[1194]	22012	26242	30472	34702	38932	43162	47392
CAM Data[1195]	22014	26244	30474	34704	38934	43164	47394
CAM Data[1196]	22016	26246	30476	34706	38936	43166	47396
CAM Data[1197]	22018	26248	30478	34708	38938	43168	47398
CAM Data[1198]	22020	26250	30480	34710	38940	43170	47400
CAM Data[1199]	22022	26252	30482	34712	38942	43172	47402
CAM Data[1200]	22024	26254	30484	34714	38944	43174	47404
CAM Data[1201]	22026	26256	30486	34716	38946	43176	47406
CAM Data[1202]	22028	26258	30488	34718	38948	43178	47408
CAM Data[1203]	22030	26260	30490	34720	38950	43180	47410
CAM Data[1204]	22032	26262	30492	34722	38952	43182	47412
CAM Data[1205]	22034	26264	30494	34724	38954	43184	47414
CAM Data[1206]	22036	26266	30496	34726	38956	43186	47416
CAM Data[1207]	22038	26268	30498	34728	38958	43188	47418
CAM Data[1208]	22040	26270	30500	34730	38960	43190	47420
CAM Data[1209]	22042	26272	30502	34732	38962	43192	47422
CAM Data[1210]	22044	26274	30504	34734	38964	43194	47424
CAM Data[1211]	22046	26276	30506	34736	38966	43196	47426
CAM Data[1212]	22048	26278	30508	34738	38968	43198	47428
CAM Data[1213]	22050	26280	30510	34740	38970	43200	47430
CAM Data[1214]	22052	26282	30512	34742	38972	43202	47432
CAM Data[1215]	22054	26284	30514	34744	38974	43204	47434
CAM Data[1216]	22056	26286	30516	34746	38976	43206	47436

Chapter 10 Internal Memory Address of “Read/Write Variable Data” command

	Block 1	Block 2	Block 3	Block 4	Block 5	Block 6	Block 7
CAM Data[1217]	22058	26288	30518	34748	38978	43208	47438
CAM Data[1218]	22060	26290	30520	34750	38980	43210	47440
CAM Data[1219]	22062	26292	30522	34752	38982	43212	47442
CAM Data[1220]	22064	26294	30524	34754	38984	43214	47444
CAM Data[1221]	22066	26296	30526	34756	38986	43216	47446
CAM Data[1222]	22068	26298	30528	34758	38988	43218	47448
CAM Data[1223]	22070	26300	30530	34760	38990	43220	47450
CAM Data[1224]	22072	26302	30532	34762	38992	43222	47452
CAM Data[1225]	22074	26304	30534	34764	38994	43224	47454
CAM Data[1226]	22076	26306	30536	34766	38996	43226	47456
CAM Data[1227]	22078	26308	30538	34768	38998	43228	47458
CAM Data[1228]	22080	26310	30540	34770	39000	43230	47460
CAM Data[1229]	22082	26312	30542	34772	39002	43232	47462
CAM Data[1230]	22084	26314	30544	34774	39004	43234	47464
CAM Data[1231]	22086	26316	30546	34776	39006	43236	47466
CAM Data[1232]	22088	26318	30548	34778	39008	43238	47468
CAM Data[1233]	22090	26320	30550	34780	39010	43240	47470
CAM Data[1234]	22092	26322	30552	34782	39012	43242	47472
CAM Data[1235]	22094	26324	30554	34784	39014	43244	47474
CAM Data[1236]	22096	26326	30556	34786	39016	43246	47476
CAM Data[1237]	22098	26328	30558	34788	39018	43248	47478
CAM Data[1238]	22100	26330	30560	34790	39020	43250	47480
CAM Data[1239]	22102	26332	30562	34792	39022	43252	47482
CAM Data[1240]	22104	26334	30564	34794	39024	43254	47484
CAM Data[1241]	22106	26336	30566	34796	39026	43256	47486
CAM Data[1242]	22108	26338	30568	34798	39028	43258	47488
CAM Data[1243]	22110	26340	30570	34800	39030	43260	47490
CAM Data[1244]	22112	26342	30572	34802	39032	43262	47492
CAM Data[1245]	22114	26344	30574	34804	39034	43264	47494
CAM Data[1246]	22116	26346	30576	34806	39036	43266	47496
CAM Data[1247]	22118	26348	30578	34808	39038	43268	47498
CAM Data[1248]	22120	26350	30580	34810	39040	43270	47500
CAM Data[1249]	22122	26352	30582	34812	39042	43272	47502
CAM Data[1250]	22124	26354	30584	34814	39044	43274	47504
CAM Data[1251]	22126	26356	30586	34816	39046	43276	47506
CAM Data[1252]	22128	26358	30588	34818	39048	43278	47508
CAM Data[1253]	22130	26360	30590	34820	39050	43280	47510
CAM Data[1254]	22132	26362	30592	34822	39052	43282	47512
CAM Data[1255]	22134	26364	30594	34824	39054	43284	47514
CAM Data[1256]	22136	26366	30596	34826	39056	43286	47516
CAM Data[1257]	22138	26368	30598	34828	39058	43288	47518
CAM Data[1258]	22140	26370	30600	34830	39060	43290	47520
CAM Data[1259]	22142	26372	30602	34832	39062	43292	47522

Chapter 10 Internal Memory Address of “Read/Write Variable Data” command

	Block 1	Block 2	Block 3	Block 4	Block 5	Block 6	Block 7
CAM Data[1260]	22144	26374	30604	34834	39064	43294	47524
CAM Data[1261]	22146	26376	30606	34836	39066	43296	47526
CAM Data[1262]	22148	26378	30608	34838	39068	43298	47528
CAM Data[1263]	22150	26380	30610	34840	39070	43300	47530
CAM Data[1264]	22152	26382	30612	34842	39072	43302	47532
CAM Data[1265]	22154	26384	30614	34844	39074	43304	47534
CAM Data[1266]	22156	26386	30616	34846	39076	43306	47536
CAM Data[1267]	22158	26388	30618	34848	39078	43308	47538
CAM Data[1268]	22160	26390	30620	34850	39080	43310	47540
CAM Data[1269]	22162	26392	30622	34852	39082	43312	47542
CAM Data[1270]	22164	26394	30624	34854	39084	43314	47544
CAM Data[1271]	22166	26396	30626	34856	39086	43316	47546
CAM Data[1272]	22168	26398	30628	34858	39088	43318	47548
CAM Data[1273]	22170	26400	30630	34860	39090	43320	47550
CAM Data[1274]	22172	26402	30632	34862	39092	43322	47552
CAM Data[1275]	22174	26404	30634	34864	39094	43324	47554
CAM Data[1276]	22176	26406	30636	34866	39096	43326	47556
CAM Data[1277]	22178	26408	30638	34868	39098	43328	47558
CAM Data[1278]	22180	26410	30640	34870	39100	43330	47560
CAM Data[1279]	22182	26412	30642	34872	39102	43332	47562
CAM Data[1280]	22184	26414	30644	34874	39104	43334	47564
CAM Data[1281]	22186	26416	30646	34876	39106	43336	47566
CAM Data[1282]	22188	26418	30648	34878	39108	43338	47568
CAM Data[1283]	22190	26420	30650	34880	39110	43340	47570
CAM Data[1284]	22192	26422	30652	34882	39112	43342	47572
CAM Data[1285]	22194	26424	30654	34884	39114	43344	47574
CAM Data[1286]	22196	26426	30656	34886	39116	43346	47576
CAM Data[1287]	22198	26428	30658	34888	39118	43348	47578
CAM Data[1288]	22200	26430	30660	34890	39120	43350	47580
CAM Data[1289]	22202	26432	30662	34892	39122	43352	47582
CAM Data[1290]	22204	26434	30664	34894	39124	43354	47584
CAM Data[1291]	22206	26436	30666	34896	39126	43356	47586
CAM Data[1292]	22208	26438	30668	34898	39128	43358	47588
CAM Data[1293]	22210	26440	30670	34900	39130	43360	47590
CAM Data[1294]	22212	26442	30672	34902	39132	43362	47592
CAM Data[1295]	22214	26444	30674	34904	39134	43364	47594
CAM Data[1296]	22216	26446	30676	34906	39136	43366	47596
CAM Data[1297]	22218	26448	30678	34908	39138	43368	47598
CAM Data[1298]	22220	26450	30680	34910	39140	43370	47600
CAM Data[1299]	22222	26452	30682	34912	39142	43372	47602
CAM Data[1300]	22224	26454	30684	34914	39144	43374	47604
CAM Data[1301]	22226	26456	30686	34916	39146	43376	47606
CAM Data[1302]	22228	26458	30688	34918	39148	43378	47608

Chapter 10 Internal Memory Address of “Read/Write Variable Data” command

	Block 1	Block 2	Block 3	Block 4	Block 5	Block 6	Block 7
CAM Data[1303]	22230	26460	30690	34920	39150	43380	47610
CAM Data[1304]	22232	26462	30692	34922	39152	43382	47612
CAM Data[1305]	22234	26464	30694	34924	39154	43384	47614
CAM Data[1306]	22236	26466	30696	34926	39156	43386	47616
CAM Data[1307]	22238	26468	30698	34928	39158	43388	47618
CAM Data[1308]	22240	26470	30700	34930	39160	43390	47620
CAM Data[1309]	22242	26472	30702	34932	39162	43392	47622
CAM Data[1310]	22244	26474	30704	34934	39164	43394	47624
CAM Data[1311]	22246	26476	30706	34936	39166	43396	47626
CAM Data[1312]	22248	26478	30708	34938	39168	43398	47628
CAM Data[1313]	22250	26480	30710	34940	39170	43400	47630
CAM Data[1314]	22252	26482	30712	34942	39172	43402	47632
CAM Data[1315]	22254	26484	30714	34944	39174	43404	47634
CAM Data[1316]	22256	26486	30716	34946	39176	43406	47636
CAM Data[1317]	22258	26488	30718	34948	39178	43408	47638
CAM Data[1318]	22260	26490	30720	34950	39180	43410	47640
CAM Data[1319]	22262	26492	30722	34952	39182	43412	47642
CAM Data[1320]	22264	26494	30724	34954	39184	43414	47644
CAM Data[1321]	22266	26496	30726	34956	39186	43416	47646
CAM Data[1322]	22268	26498	30728	34958	39188	43418	47648
CAM Data[1323]	22270	26500	30730	34960	39190	43420	47650
CAM Data[1324]	22272	26502	30732	34962	39192	43422	47652
CAM Data[1325]	22274	26504	30734	34964	39194	43424	47654
CAM Data[1326]	22276	26506	30736	34966	39196	43426	47656
CAM Data[1327]	22278	26508	30738	34968	39198	43428	47658
CAM Data[1328]	22280	26510	30740	34970	39200	43430	47660
CAM Data[1329]	22282	26512	30742	34972	39202	43432	47662
CAM Data[1330]	22284	26514	30744	34974	39204	43434	47664
CAM Data[1331]	22286	26516	30746	34976	39206	43436	47666
CAM Data[1332]	22288	26518	30748	34978	39208	43438	47668
CAM Data[1333]	22290	26520	30750	34980	39210	43440	47670
CAM Data[1334]	22292	26522	30752	34982	39212	43442	47672
CAM Data[1335]	22294	26524	30754	34984	39214	43444	47674
CAM Data[1336]	22296	26526	30756	34986	39216	43446	47676
CAM Data[1337]	22298	26528	30758	34988	39218	43448	47678
CAM Data[1338]	22300	26530	30760	34990	39220	43450	47680
CAM Data[1339]	22302	26532	30762	34992	39222	43452	47682
CAM Data[1340]	22304	26534	30764	34994	39224	43454	47684
CAM Data[1341]	22306	26536	30766	34996	39226	43456	47686
CAM Data[1342]	22308	26538	30768	34998	39228	43458	47688
CAM Data[1343]	22310	26540	30770	35000	39230	43460	47690
CAM Data[1344]	22312	26542	30772	35002	39232	43462	47692
CAM Data[1345]	22314	26544	30774	35004	39234	43464	47694

Chapter 10 Internal Memory Address of “Read/Write Variable Data” command

	Block 1	Block 2	Block 3	Block 4	Block 5	Block 6	Block 7
CAM Data[1346]	22316	26546	30776	35006	39236	43466	47696
CAM Data[1347]	22318	26548	30778	35008	39238	43468	47698
CAM Data[1348]	22320	26550	30780	35010	39240	43470	47700
CAM Data[1349]	22322	26552	30782	35012	39242	43472	47702
CAM Data[1350]	22324	26554	30784	35014	39244	43474	47704
CAM Data[1351]	22326	26556	30786	35016	39246	43476	47706
CAM Data[1352]	22328	26558	30788	35018	39248	43478	47708
CAM Data[1353]	22330	26560	30790	35020	39250	43480	47710
CAM Data[1354]	22332	26562	30792	35022	39252	43482	47712
CAM Data[1355]	22334	26564	30794	35024	39254	43484	47714
CAM Data[1356]	22336	26566	30796	35026	39256	43486	47716
CAM Data[1357]	22338	26568	30798	35028	39258	43488	47718
CAM Data[1358]	22340	26570	30800	35030	39260	43490	47720
CAM Data[1359]	22342	26572	30802	35032	39262	43492	47722
CAM Data[1360]	22344	26574	30804	35034	39264	43494	47724
CAM Data[1361]	22346	26576	30806	35036	39266	43496	47726
CAM Data[1362]	22348	26578	30808	35038	39268	43498	47728
CAM Data[1363]	22350	26580	30810	35040	39270	43500	47730
CAM Data[1364]	22352	26582	30812	35042	39272	43502	47732
CAM Data[1365]	22354	26584	30814	35044	39274	43504	47734
CAM Data[1366]	22356	26586	30816	35046	39276	43506	47736
CAM Data[1367]	22358	26588	30818	35048	39278	43508	47738
CAM Data[1368]	22360	26590	30820	35050	39280	43510	47740
CAM Data[1369]	22362	26592	30822	35052	39282	43512	47742
CAM Data[1370]	22364	26594	30824	35054	39284	43514	47744
CAM Data[1371]	22366	26596	30826	35056	39286	43516	47746
CAM Data[1372]	22368	26598	30828	35058	39288	43518	47748
CAM Data[1373]	22370	26600	30830	35060	39290	43520	47750
CAM Data[1374]	22372	26602	30832	35062	39292	43522	47752
CAM Data[1375]	22374	26604	30834	35064	39294	43524	47754
CAM Data[1376]	22376	26606	30836	35066	39296	43526	47756
CAM Data[1377]	22378	26608	30838	35068	39298	43528	47758
CAM Data[1378]	22380	26610	30840	35070	39300	43530	47760
CAM Data[1379]	22382	26612	30842	35072	39302	43532	47762
CAM Data[1380]	22384	26614	30844	35074	39304	43534	47764
CAM Data[1381]	22386	26616	30846	35076	39306	43536	47766
CAM Data[1382]	22388	26618	30848	35078	39308	43538	47768
CAM Data[1383]	22390	26620	30850	35080	39310	43540	47770
CAM Data[1384]	22392	26622	30852	35082	39312	43542	47772
CAM Data[1385]	22394	26624	30854	35084	39314	43544	47774
CAM Data[1386]	22396	26626	30856	35086	39316	43546	47776
CAM Data[1387]	22398	26628	30858	35088	39318	43548	47778
CAM Data[1388]	22400	26630	30860	35090	39320	43550	47780

Chapter 10 Internal Memory Address of “Read/Write Variable Data” command

	Block 1	Block 2	Block 3	Block 4	Block 5	Block 6	Block 7
CAM Data[1389]	22402	26632	30862	35092	39322	43552	47782
CAM Data[1390]	22404	26634	30864	35094	39324	43554	47784
CAM Data[1391]	22406	26636	30866	35096	39326	43556	47786
CAM Data[1392]	22408	26638	30868	35098	39328	43558	47788
CAM Data[1393]	22410	26640	30870	35100	39330	43560	47790
CAM Data[1394]	22412	26642	30872	35102	39332	43562	47792
CAM Data[1395]	22414	26644	30874	35104	39334	43564	47794
CAM Data[1396]	22416	26646	30876	35106	39336	43566	47796
CAM Data[1397]	22418	26648	30878	35108	39338	43568	47798
CAM Data[1398]	22420	26650	30880	35110	39340	43570	47800
CAM Data[1399]	22422	26652	30882	35112	39342	43572	47802
CAM Data[1400]	22424	26654	30884	35114	39344	43574	47804
CAM Data[1401]	22426	26656	30886	35116	39346	43576	47806
CAM Data[1402]	22428	26658	30888	35118	39348	43578	47808
CAM Data[1403]	22430	26660	30890	35120	39350	43580	47810
CAM Data[1404]	22432	26662	30892	35122	39352	43582	47812
CAM Data[1405]	22434	26664	30894	35124	39354	43584	47814
CAM Data[1406]	22436	26666	30896	35126	39356	43586	47816
CAM Data[1407]	22438	26668	30898	35128	39358	43588	47818
CAM Data[1408]	22440	26670	30900	35130	39360	43590	47820
CAM Data[1409]	22442	26672	30902	35132	39362	43592	47822
CAM Data[1410]	22444	26674	30904	35134	39364	43594	47824
CAM Data[1411]	22446	26676	30906	35136	39366	43596	47826
CAM Data[1412]	22448	26678	30908	35138	39368	43598	47828
CAM Data[1413]	22450	26680	30910	35140	39370	43600	47830
CAM Data[1414]	22452	26682	30912	35142	39372	43602	47832
CAM Data[1415]	22454	26684	30914	35144	39374	43604	47834
CAM Data[1416]	22456	26686	30916	35146	39376	43606	47836
CAM Data[1417]	22458	26688	30918	35148	39378	43608	47838
CAM Data[1418]	22460	26690	30920	35150	39380	43610	47840
CAM Data[1419]	22462	26692	30922	35152	39382	43612	47842
CAM Data[1420]	22464	26694	30924	35154	39384	43614	47844
CAM Data[1421]	22466	26696	30926	35156	39386	43616	47846
CAM Data[1422]	22468	26698	30928	35158	39388	43618	47848
CAM Data[1423]	22470	26700	30930	35160	39390	43620	47850
CAM Data[1424]	22472	26702	30932	35162	39392	43622	47852
CAM Data[1425]	22474	26704	30934	35164	39394	43624	47854
CAM Data[1426]	22476	26706	30936	35166	39396	43626	47856
CAM Data[1427]	22478	26708	30938	35168	39398	43628	47858
CAM Data[1428]	22480	26710	30940	35170	39400	43630	47860
CAM Data[1429]	22482	26712	30942	35172	39402	43632	47862
CAM Data[1430]	22484	26714	30944	35174	39404	43634	47864
CAM Data[1431]	22486	26716	30946	35176	39406	43636	47866

Chapter 10 Internal Memory Address of “Read/Write Variable Data” command

	Block 1	Block 2	Block 3	Block 4	Block 5	Block 6	Block 7
CAM Data[1432]	22488	26718	30948	35178	39408	43638	47868
CAM Data[1433]	22490	26720	30950	35180	39410	43640	47870
CAM Data[1434]	22492	26722	30952	35182	39412	43642	47872
CAM Data[1435]	22494	26724	30954	35184	39414	43644	47874
CAM Data[1436]	22496	26726	30956	35186	39416	43646	47876
CAM Data[1437]	22498	26728	30958	35188	39418	43648	47878
CAM Data[1438]	22500	26730	30960	35190	39420	43650	47880
CAM Data[1439]	22502	26732	30962	35192	39422	43652	47882
CAM Data[1440]	22504	26734	30964	35194	39424	43654	47884
CAM Data[1441]	22506	26736	30966	35196	39426	43656	47886
CAM Data[1442]	22508	26738	30968	35198	39428	43658	47888
CAM Data[1443]	22510	26740	30970	35200	39430	43660	47890
CAM Data[1444]	22512	26742	30972	35202	39432	43662	47892
CAM Data[1445]	22514	26744	30974	35204	39434	43664	47894
CAM Data[1446]	22516	26746	30976	35206	39436	43666	47896
CAM Data[1447]	22518	26748	30978	35208	39438	43668	47898
CAM Data[1448]	22520	26750	30980	35210	39440	43670	47900
CAM Data[1449]	22522	26752	30982	35212	39442	43672	47902
CAM Data[1450]	22524	26754	30984	35214	39444	43674	47904
CAM Data[1451]	22526	26756	30986	35216	39446	43676	47906
CAM Data[1452]	22528	26758	30988	35218	39448	43678	47908
CAM Data[1453]	22530	26760	30990	35220	39450	43680	47910
CAM Data[1454]	22532	26762	30992	35222	39452	43682	47912
CAM Data[1455]	22534	26764	30994	35224	39454	43684	47914
CAM Data[1456]	22536	26766	30996	35226	39456	43686	47916
CAM Data[1457]	22538	26768	30998	35228	39458	43688	47918
CAM Data[1458]	22540	26770	31000	35230	39460	43690	47920
CAM Data[1459]	22542	26772	31002	35232	39462	43692	47922
CAM Data[1460]	22544	26774	31004	35234	39464	43694	47924
CAM Data[1461]	22546	26776	31006	35236	39466	43696	47926
CAM Data[1462]	22548	26778	31008	35238	39468	43698	47928
CAM Data[1463]	22550	26780	31010	35240	39470	43700	47930
CAM Data[1464]	22552	26782	31012	35242	39472	43702	47932
CAM Data[1465]	22554	26784	31014	35244	39474	43704	47934
CAM Data[1466]	22556	26786	31016	35246	39476	43706	47936
CAM Data[1467]	22558	26788	31018	35248	39478	43708	47938
CAM Data[1468]	22560	26790	31020	35250	39480	43710	47940
CAM Data[1469]	22562	26792	31022	35252	39482	43712	47942
CAM Data[1470]	22564	26794	31024	35254	39484	43714	47944
CAM Data[1471]	22566	26796	31026	35256	39486	43716	47946
CAM Data[1472]	22568	26798	31028	35258	39488	43718	47948
CAM Data[1473]	22570	26800	31030	35260	39490	43720	47950
CAM Data[1474]	22572	26802	31032	35262	39492	43722	47952

Chapter 10 Internal Memory Address of “Read/Write Variable Data” command

	Block 1	Block 2	Block 3	Block 4	Block 5	Block 6	Block 7
CAM Data[1475]	22574	26804	31034	35264	39494	43724	47954
CAM Data[1476]	22576	26806	31036	35266	39496	43726	47956
CAM Data[1477]	22578	26808	31038	35268	39498	43728	47958
CAM Data[1478]	22580	26810	31040	35270	39500	43730	47960
CAM Data[1479]	22582	26812	31042	35272	39502	43732	47962
CAM Data[1480]	22584	26814	31044	35274	39504	43734	47964
CAM Data[1481]	22586	26816	31046	35276	39506	43736	47966
CAM Data[1482]	22588	26818	31048	35278	39508	43738	47968
CAM Data[1483]	22590	26820	31050	35280	39510	43740	47970
CAM Data[1484]	22592	26822	31052	35282	39512	43742	47972
CAM Data[1485]	22594	26824	31054	35284	39514	43744	47974
CAM Data[1486]	22596	26826	31056	35286	39516	43746	47976
CAM Data[1487]	22598	26828	31058	35288	39518	43748	47978
CAM Data[1488]	22600	26830	31060	35290	39520	43750	47980
CAM Data[1489]	22602	26832	31062	35292	39522	43752	47982
CAM Data[1490]	22604	26834	31064	35294	39524	43754	47984
CAM Data[1491]	22606	26836	31066	35296	39526	43756	47986
CAM Data[1492]	22608	26838	31068	35298	39528	43758	47988
CAM Data[1493]	22610	26840	31070	35300	39530	43760	47990
CAM Data[1494]	22612	26842	31072	35302	39532	43762	47992
CAM Data[1495]	22614	26844	31074	35304	39534	43764	47994
CAM Data[1496]	22616	26846	31076	35306	39536	43766	47996
CAM Data[1497]	22618	26848	31078	35308	39538	43768	47998
CAM Data[1498]	22620	26850	31080	35310	39540	43770	48000
CAM Data[1499]	22622	26852	31082	35312	39542	43772	48002
CAM Data[1500]	22624	26854	31084	35314	39544	43774	48004
CAM Data[1501]	22626	26856	31086	35316	39546	43776	48006
CAM Data[1502]	22628	26858	31088	35318	39548	43778	48008
CAM Data[1503]	22630	26860	31090	35320	39550	43780	48010
CAM Data[1504]	22632	26862	31092	35322	39552	43782	48012
CAM Data[1505]	22634	26864	31094	35324	39554	43784	48014
CAM Data[1506]	22636	26866	31096	35326	39556	43786	48016
CAM Data[1507]	22638	26868	31098	35328	39558	43788	48018
CAM Data[1508]	22640	26870	31100	35330	39560	43790	48020
CAM Data[1509]	22642	26872	31102	35332	39562	43792	48022
CAM Data[1510]	22644	26874	31104	35334	39564	43794	48024
CAM Data[1511]	22646	26876	31106	35336	39566	43796	48026
CAM Data[1512]	22648	26878	31108	35338	39568	43798	48028
CAM Data[1513]	22650	26880	31110	35340	39570	43800	48030
CAM Data[1514]	22652	26882	31112	35342	39572	43802	48032
CAM Data[1515]	22654	26884	31114	35344	39574	43804	48034
CAM Data[1516]	22656	26886	31116	35346	39576	43806	48036
CAM Data[1517]	22658	26888	31118	35348	39578	43808	48038

Chapter 10 Internal Memory Address of “Read/Write Variable Data” command

	Block 1	Block 2	Block 3	Block 4	Block 5	Block 6	Block 7
CAM Data[1518]	22660	26890	31120	35350	39580	43810	48040
CAM Data[1519]	22662	26892	31122	35352	39582	43812	48042
CAM Data[1520]	22664	26894	31124	35354	39584	43814	48044
CAM Data[1521]	22666	26896	31126	35356	39586	43816	48046
CAM Data[1522]	22668	26898	31128	35358	39588	43818	48048
CAM Data[1523]	22670	26900	31130	35360	39590	43820	48050
CAM Data[1524]	22672	26902	31132	35362	39592	43822	48052
CAM Data[1525]	22674	26904	31134	35364	39594	43824	48054
CAM Data[1526]	22676	26906	31136	35366	39596	43826	48056
CAM Data[1527]	22678	26908	31138	35368	39598	43828	48058
CAM Data[1528]	22680	26910	31140	35370	39600	43830	48060
CAM Data[1529]	22682	26912	31142	35372	39602	43832	48062
CAM Data[1530]	22684	26914	31144	35374	39604	43834	48064
CAM Data[1531]	22686	26916	31146	35376	39606	43836	48066
CAM Data[1532]	22688	26918	31148	35378	39608	43838	48068
CAM Data[1533]	22690	26920	31150	35380	39610	43840	48070
CAM Data[1534]	22692	26922	31152	35382	39612	43842	48072
CAM Data[1535]	22694	26924	31154	35384	39614	43844	48074
CAM Data[1536]	22696	26926	31156	35386	39616	43846	48076
CAM Data[1537]	22698	26928	31158	35388	39618	43848	48078
CAM Data[1538]	22700	26930	31160	35390	39620	43850	48080
CAM Data[1539]	22702	26932	31162	35392	39622	43852	48082
CAM Data[1540]	22704	26934	31164	35394	39624	43854	48084
CAM Data[1541]	22706	26936	31166	35396	39626	43856	48086
CAM Data[1542]	22708	26938	31168	35398	39628	43858	48088
CAM Data[1543]	22710	26940	31170	35400	39630	43860	48090
CAM Data[1544]	22712	26942	31172	35402	39632	43862	48092
CAM Data[1545]	22714	26944	31174	35404	39634	43864	48094
CAM Data[1546]	22716	26946	31176	35406	39636	43866	48096
CAM Data[1547]	22718	26948	31178	35408	39638	43868	48098
CAM Data[1548]	22720	26950	31180	35410	39640	43870	48100
CAM Data[1549]	22722	26952	31182	35412	39642	43872	48102
CAM Data[1550]	22724	26954	31184	35414	39644	43874	48104
CAM Data[1551]	22726	26956	31186	35416	39646	43876	48106
CAM Data[1552]	22728	26958	31188	35418	39648	43878	48108
CAM Data[1553]	22730	26960	31190	35420	39650	43880	48110
CAM Data[1554]	22732	26962	31192	35422	39652	43882	48112
CAM Data[1555]	22734	26964	31194	35424	39654	43884	48114
CAM Data[1556]	22736	26966	31196	35426	39656	43886	48116
CAM Data[1557]	22738	26968	31198	35428	39658	43888	48118
CAM Data[1558]	22740	26970	31200	35430	39660	43890	48120
CAM Data[1559]	22742	26972	31202	35432	39662	43892	48122
CAM Data[1560]	22744	26974	31204	35434	39664	43894	48124

Chapter 10 Internal Memory Address of “Read/Write Variable Data” command

	Block 1	Block 2	Block 3	Block 4	Block 5	Block 6	Block 7
CAM Data[1561]	22746	26976	31206	35436	39666	43896	48126
CAM Data[1562]	22748	26978	31208	35438	39668	43898	48128
CAM Data[1563]	22750	26980	31210	35440	39670	43900	48130
CAM Data[1564]	22752	26982	31212	35442	39672	43902	48132
CAM Data[1565]	22754	26984	31214	35444	39674	43904	48134
CAM Data[1566]	22756	26986	31216	35446	39676	43906	48136
CAM Data[1567]	22758	26988	31218	35448	39678	43908	48138
CAM Data[1568]	22760	26990	31220	35450	39680	43910	48140
CAM Data[1569]	22762	26992	31222	35452	39682	43912	48142
CAM Data[1570]	22764	26994	31224	35454	39684	43914	48144
CAM Data[1571]	22766	26996	31226	35456	39686	43916	48146
CAM Data[1572]	22768	26998	31228	35458	39688	43918	48148
CAM Data[1573]	22770	27000	31230	35460	39690	43920	48150
CAM Data[1574]	22772	27002	31232	35462	39692	43922	48152
CAM Data[1575]	22774	27004	31234	35464	39694	43924	48154
CAM Data[1576]	22776	27006	31236	35466	39696	43926	48156
CAM Data[1577]	22778	27008	31238	35468	39698	43928	48158
CAM Data[1578]	22780	27010	31240	35470	39700	43930	48160
CAM Data[1579]	22782	27012	31242	35472	39702	43932	48162
CAM Data[1580]	22784	27014	31244	35474	39704	43934	48164
CAM Data[1581]	22786	27016	31246	35476	39706	43936	48166
CAM Data[1582]	22788	27018	31248	35478	39708	43938	48168
CAM Data[1583]	22790	27020	31250	35480	39710	43940	48170
CAM Data[1584]	22792	27022	31252	35482	39712	43942	48172
CAM Data[1585]	22794	27024	31254	35484	39714	43944	48174
CAM Data[1586]	22796	27026	31256	35486	39716	43946	48176
CAM Data[1587]	22798	27028	31258	35488	39718	43948	48178
CAM Data[1588]	22800	27030	31260	35490	39720	43950	48180
CAM Data[1589]	22802	27032	31262	35492	39722	43952	48182
CAM Data[1590]	22804	27034	31264	35494	39724	43954	48184
CAM Data[1591]	22806	27036	31266	35496	39726	43956	48186
CAM Data[1592]	22808	27038	31268	35498	39728	43958	48188
CAM Data[1593]	22810	27040	31270	35500	39730	43960	48190
CAM Data[1594]	22812	27042	31272	35502	39732	43962	48192
CAM Data[1595]	22814	27044	31274	35504	39734	43964	48194
CAM Data[1596]	22816	27046	31276	35506	39736	43966	48196
CAM Data[1597]	22818	27048	31278	35508	39738	43968	48198
CAM Data[1598]	22820	27050	31280	35510	39740	43970	48200
CAM Data[1599]	22822	27052	31282	35512	39742	43972	48202
CAM Data[1600]	22824	27054	31284	35514	39744	43974	48204
CAM Data[1601]	22826	27056	31286	35516	39746	43976	48206
CAM Data[1602]	22828	27058	31288	35518	39748	43978	48208
CAM Data[1603]	22830	27060	31290	35520	39750	43980	48210

Chapter 10 Internal Memory Address of “Read/Write Variable Data” command

	Block 1	Block 2	Block 3	Block 4	Block 5	Block 6	Block 7
CAM Data[1604]	22832	27062	31292	35522	39752	43982	48212
CAM Data[1605]	22834	27064	31294	35524	39754	43984	48214
CAM Data[1606]	22836	27066	31296	35526	39756	43986	48216
CAM Data[1607]	22838	27068	31298	35528	39758	43988	48218
CAM Data[1608]	22840	27070	31300	35530	39760	43990	48220
CAM Data[1609]	22842	27072	31302	35532	39762	43992	48222
CAM Data[1610]	22844	27074	31304	35534	39764	43994	48224
CAM Data[1611]	22846	27076	31306	35536	39766	43996	48226
CAM Data[1612]	22848	27078	31308	35538	39768	43998	48228
CAM Data[1613]	22850	27080	31310	35540	39770	44000	48230
CAM Data[1614]	22852	27082	31312	35542	39772	44002	48232
CAM Data[1615]	22854	27084	31314	35544	39774	44004	48234
CAM Data[1616]	22856	27086	31316	35546	39776	44006	48236
CAM Data[1617]	22858	27088	31318	35548	39778	44008	48238
CAM Data[1618]	22860	27090	31320	35550	39780	44010	48240
CAM Data[1619]	22862	27092	31322	35552	39782	44012	48242
CAM Data[1620]	22864	27094	31324	35554	39784	44014	48244
CAM Data[1621]	22866	27096	31326	35556	39786	44016	48246
CAM Data[1622]	22868	27098	31328	35558	39788	44018	48248
CAM Data[1623]	22870	27100	31330	35560	39790	44020	48250
CAM Data[1624]	22872	27102	31332	35562	39792	44022	48252
CAM Data[1625]	22874	27104	31334	35564	39794	44024	48254
CAM Data[1626]	22876	27106	31336	35566	39796	44026	48256
CAM Data[1627]	22878	27108	31338	35568	39798	44028	48258
CAM Data[1628]	22880	27110	31340	35570	39800	44030	48260
CAM Data[1629]	22882	27112	31342	35572	39802	44032	48262
CAM Data[1630]	22884	27114	31344	35574	39804	44034	48264
CAM Data[1631]	22886	27116	31346	35576	39806	44036	48266
CAM Data[1632]	22888	27118	31348	35578	39808	44038	48268
CAM Data[1633]	22890	27120	31350	35580	39810	44040	48270
CAM Data[1634]	22892	27122	31352	35582	39812	44042	48272
CAM Data[1635]	22894	27124	31354	35584	39814	44044	48274
CAM Data[1636]	22896	27126	31356	35586	39816	44046	48276
CAM Data[1637]	22898	27128	31358	35588	39818	44048	48278
CAM Data[1638]	22900	27130	31360	35590	39820	44050	48280
CAM Data[1639]	22902	27132	31362	35592	39822	44052	48282
CAM Data[1640]	22904	27134	31364	35594	39824	44054	48284
CAM Data[1641]	22906	27136	31366	35596	39826	44056	48286
CAM Data[1642]	22908	27138	31368	35598	39828	44058	48288
CAM Data[1643]	22910	27140	31370	35600	39830	44060	48290
CAM Data[1644]	22912	27142	31372	35602	39832	44062	48292
CAM Data[1645]	22914	27144	31374	35604	39834	44064	48294
CAM Data[1646]	22916	27146	31376	35606	39836	44066	48296

Chapter 10 Internal Memory Address of “Read/Write Variable Data” command

	Block 1	Block 2	Block 3	Block 4	Block 5	Block 6	Block 7
CAM Data[1647]	22918	27148	31378	35608	39838	44068	48298
CAM Data[1648]	22920	27150	31380	35610	39840	44070	48300
CAM Data[1649]	22922	27152	31382	35612	39842	44072	48302
CAM Data[1650]	22924	27154	31384	35614	39844	44074	48304
CAM Data[1651]	22926	27156	31386	35616	39846	44076	48306
CAM Data[1652]	22928	27158	31388	35618	39848	44078	48308
CAM Data[1653]	22930	27160	31390	35620	39850	44080	48310
CAM Data[1654]	22932	27162	31392	35622	39852	44082	48312
CAM Data[1655]	22934	27164	31394	35624	39854	44084	48314
CAM Data[1656]	22936	27166	31396	35626	39856	44086	48316
CAM Data[1657]	22938	27168	31398	35628	39858	44088	48318
CAM Data[1658]	22940	27170	31400	35630	39860	44090	48320
CAM Data[1659]	22942	27172	31402	35632	39862	44092	48322
CAM Data[1660]	22944	27174	31404	35634	39864	44094	48324
CAM Data[1661]	22946	27176	31406	35636	39866	44096	48326
CAM Data[1662]	22948	27178	31408	35638	39868	44098	48328
CAM Data[1663]	22950	27180	31410	35640	39870	44100	48330
CAM Data[1664]	22952	27182	31412	35642	39872	44102	48332
CAM Data[1665]	22954	27184	31414	35644	39874	44104	48334
CAM Data[1666]	22956	27186	31416	35646	39876	44106	48336
CAM Data[1667]	22958	27188	31418	35648	39878	44108	48338
CAM Data[1668]	22960	27190	31420	35650	39880	44110	48340
CAM Data[1669]	22962	27192	31422	35652	39882	44112	48342
CAM Data[1670]	22964	27194	31424	35654	39884	44114	48344
CAM Data[1671]	22966	27196	31426	35656	39886	44116	48346
CAM Data[1672]	22968	27198	31428	35658	39888	44118	48348
CAM Data[1673]	22970	27200	31430	35660	39890	44120	48350
CAM Data[1674]	22972	27202	31432	35662	39892	44122	48352
CAM Data[1675]	22974	27204	31434	35664	39894	44124	48354
CAM Data[1676]	22976	27206	31436	35666	39896	44126	48356
CAM Data[1677]	22978	27208	31438	35668	39898	44128	48358
CAM Data[1678]	22980	27210	31440	35670	39900	44130	48360
CAM Data[1679]	22982	27212	31442	35672	39902	44132	48362
CAM Data[1680]	22984	27214	31444	35674	39904	44134	48364
CAM Data[1681]	22986	27216	31446	35676	39906	44136	48366
CAM Data[1682]	22988	27218	31448	35678	39908	44138	48368
CAM Data[1683]	22990	27220	31450	35680	39910	44140	48370
CAM Data[1684]	22992	27222	31452	35682	39912	44142	48372
CAM Data[1685]	22994	27224	31454	35684	39914	44144	48374
CAM Data[1686]	22996	27226	31456	35686	39916	44146	48376
CAM Data[1687]	22998	27228	31458	35688	39918	44148	48378
CAM Data[1688]	23000	27230	31460	35690	39920	44150	48380
CAM Data[1689]	23002	27232	31462	35692	39922	44152	48382

Chapter 10 Internal Memory Address of “Read/Write Variable Data” command

	Block 1	Block 2	Block 3	Block 4	Block 5	Block 6	Block 7
CAM Data[1690]	23004	27234	31464	35694	39924	44154	48384
CAM Data[1691]	23006	27236	31466	35696	39926	44156	48386
CAM Data[1692]	23008	27238	31468	35698	39928	44158	48388
CAM Data[1693]	23010	27240	31470	35700	39930	44160	48390
CAM Data[1694]	23012	27242	31472	35702	39932	44162	48392
CAM Data[1695]	23014	27244	31474	35704	39934	44164	48394
CAM Data[1696]	23016	27246	31476	35706	39936	44166	48396
CAM Data[1697]	23018	27248	31478	35708	39938	44168	48398
CAM Data[1698]	23020	27250	31480	35710	39940	44170	48400
CAM Data[1699]	23022	27252	31482	35712	39942	44172	48402
CAM Data[1700]	23024	27254	31484	35714	39944	44174	48404
CAM Data[1701]	23026	27256	31486	35716	39946	44176	48406
CAM Data[1702]	23028	27258	31488	35718	39948	44178	48408
CAM Data[1703]	23030	27260	31490	35720	39950	44180	48410
CAM Data[1704]	23032	27262	31492	35722	39952	44182	48412
CAM Data[1705]	23034	27264	31494	35724	39954	44184	48414
CAM Data[1706]	23036	27266	31496	35726	39956	44186	48416
CAM Data[1707]	23038	27268	31498	35728	39958	44188	48418
CAM Data[1708]	23040	27270	31500	35730	39960	44190	48420
CAM Data[1709]	23042	27272	31502	35732	39962	44192	48422
CAM Data[1710]	23044	27274	31504	35734	39964	44194	48424
CAM Data[1711]	23046	27276	31506	35736	39966	44196	48426
CAM Data[1712]	23048	27278	31508	35738	39968	44198	48428
CAM Data[1713]	23050	27280	31510	35740	39970	44200	48430
CAM Data[1714]	23052	27282	31512	35742	39972	44202	48432
CAM Data[1715]	23054	27284	31514	35744	39974	44204	48434
CAM Data[1716]	23056	27286	31516	35746	39976	44206	48436
CAM Data[1717]	23058	27288	31518	35748	39978	44208	48438
CAM Data[1718]	23060	27290	31520	35750	39980	44210	48440
CAM Data[1719]	23062	27292	31522	35752	39982	44212	48442
CAM Data[1720]	23064	27294	31524	35754	39984	44214	48444
CAM Data[1721]	23066	27296	31526	35756	39986	44216	48446
CAM Data[1722]	23068	27298	31528	35758	39988	44218	48448
CAM Data[1723]	23070	27300	31530	35760	39990	44220	48450
CAM Data[1724]	23072	27302	31532	35762	39992	44222	48452
CAM Data[1725]	23074	27304	31534	35764	39994	44224	48454
CAM Data[1726]	23076	27306	31536	35766	39996	44226	48456
CAM Data[1727]	23078	27308	31538	35768	39998	44228	48458
CAM Data[1728]	23080	27310	31540	35770	40000	44230	48460
CAM Data[1729]	23082	27312	31542	35772	40002	44232	48462
CAM Data[1730]	23084	27314	31544	35774	40004	44234	48464
CAM Data[1731]	23086	27316	31546	35776	40006	44236	48466
CAM Data[1732]	23088	27318	31548	35778	40008	44238	48468

Chapter 10 Internal Memory Address of “Read/Write Variable Data” command

	Block 1	Block 2	Block 3	Block 4	Block 5	Block 6	Block 7
CAM Data[1733]	23090	27320	31550	35780	40010	44240	48470
CAM Data[1734]	23092	27322	31552	35782	40012	44242	48472
CAM Data[1735]	23094	27324	31554	35784	40014	44244	48474
CAM Data[1736]	23096	27326	31556	35786	40016	44246	48476
CAM Data[1737]	23098	27328	31558	35788	40018	44248	48478
CAM Data[1738]	23100	27330	31560	35790	40020	44250	48480
CAM Data[1739]	23102	27332	31562	35792	40022	44252	48482
CAM Data[1740]	23104	27334	31564	35794	40024	44254	48484
CAM Data[1741]	23106	27336	31566	35796	40026	44256	48486
CAM Data[1742]	23108	27338	31568	35798	40028	44258	48488
CAM Data[1743]	23110	27340	31570	35800	40030	44260	48490
CAM Data[1744]	23112	27342	31572	35802	40032	44262	48492
CAM Data[1745]	23114	27344	31574	35804	40034	44264	48494
CAM Data[1746]	23116	27346	31576	35806	40036	44266	48496
CAM Data[1747]	23118	27348	31578	35808	40038	44268	48498
CAM Data[1748]	23120	27350	31580	35810	40040	44270	48500
CAM Data[1749]	23122	27352	31582	35812	40042	44272	48502
CAM Data[1750]	23124	27354	31584	35814	40044	44274	48504
CAM Data[1751]	23126	27356	31586	35816	40046	44276	48506
CAM Data[1752]	23128	27358	31588	35818	40048	44278	48508
CAM Data[1753]	23130	27360	31590	35820	40050	44280	48510
CAM Data[1754]	23132	27362	31592	35822	40052	44282	48512
CAM Data[1755]	23134	27364	31594	35824	40054	44284	48514
CAM Data[1756]	23136	27366	31596	35826	40056	44286	48516
CAM Data[1757]	23138	27368	31598	35828	40058	44288	48518
CAM Data[1758]	23140	27370	31600	35830	40060	44290	48520
CAM Data[1759]	23142	27372	31602	35832	40062	44292	48522
CAM Data[1760]	23144	27374	31604	35834	40064	44294	48524
CAM Data[1761]	23146	27376	31606	35836	40066	44296	48526
CAM Data[1762]	23148	27378	31608	35838	40068	44298	48528
CAM Data[1763]	23150	27380	31610	35840	40070	44300	48530
CAM Data[1764]	23152	27382	31612	35842	40072	44302	48532
CAM Data[1765]	23154	27384	31614	35844	40074	44304	48534
CAM Data[1766]	23156	27386	31616	35846	40076	44306	48536
CAM Data[1767]	23158	27388	31618	35848	40078	44308	48538
CAM Data[1768]	23160	27390	31620	35850	40080	44310	48540
CAM Data[1769]	23162	27392	31622	35852	40082	44312	48542
CAM Data[1770]	23164	27394	31624	35854	40084	44314	48544
CAM Data[1771]	23166	27396	31626	35856	40086	44316	48546
CAM Data[1772]	23168	27398	31628	35858	40088	44318	48548
CAM Data[1773]	23170	27400	31630	35860	40090	44320	48550
CAM Data[1774]	23172	27402	31632	35862	40092	44322	48552
CAM Data[1775]	23174	27404	31634	35864	40094	44324	48554

Chapter 10 Internal Memory Address of “Read/Write Variable Data” command

	Block 1	Block 2	Block 3	Block 4	Block 5	Block 6	Block 7
CAM Data[1776]	23176	27406	31636	35866	40096	44326	48556
CAM Data[1777]	23178	27408	31638	35868	40098	44328	48558
CAM Data[1778]	23180	27410	31640	35870	40100	44330	48560
CAM Data[1779]	23182	27412	31642	35872	40102	44332	48562
CAM Data[1780]	23184	27414	31644	35874	40104	44334	48564
CAM Data[1781]	23186	27416	31646	35876	40106	44336	48566
CAM Data[1782]	23188	27418	31648	35878	40108	44338	48568
CAM Data[1783]	23190	27420	31650	35880	40110	44340	48570
CAM Data[1784]	23192	27422	31652	35882	40112	44342	48572
CAM Data[1785]	23194	27424	31654	35884	40114	44344	48574
CAM Data[1786]	23196	27426	31656	35886	40116	44346	48576
CAM Data[1787]	23198	27428	31658	35888	40118	44348	48578
CAM Data[1788]	23200	27430	31660	35890	40120	44350	48580
CAM Data[1789]	23202	27432	31662	35892	40122	44352	48582
CAM Data[1790]	23204	27434	31664	35894	40124	44354	48584
CAM Data[1791]	23206	27436	31666	35896	40126	44356	48586
CAM Data[1792]	23208	27438	31668	35898	40128	44358	48588
CAM Data[1793]	23210	27440	31670	35900	40130	44360	48590
CAM Data[1794]	23212	27442	31672	35902	40132	44362	48592
CAM Data[1795]	23214	27444	31674	35904	40134	44364	48594
CAM Data[1796]	23216	27446	31676	35906	40136	44366	48596
CAM Data[1797]	23218	27448	31678	35908	40138	44368	48598
CAM Data[1798]	23220	27450	31680	35910	40140	44370	48600
CAM Data[1799]	23222	27452	31682	35912	40142	44372	48602
CAM Data[1800]	23224	27454	31684	35914	40144	44374	48604
CAM Data[1801]	23226	27456	31686	35916	40146	44376	48606
CAM Data[1802]	23228	27458	31688	35918	40148	44378	48608
CAM Data[1803]	23230	27460	31690	35920	40150	44380	48610
CAM Data[1804]	23232	27462	31692	35922	40152	44382	48612
CAM Data[1805]	23234	27464	31694	35924	40154	44384	48614
CAM Data[1806]	23236	27466	31696	35926	40156	44386	48616
CAM Data[1807]	23238	27468	31698	35928	40158	44388	48618
CAM Data[1808]	23240	27470	31700	35930	40160	44390	48620
CAM Data[1809]	23242	27472	31702	35932	40162	44392	48622
CAM Data[1810]	23244	27474	31704	35934	40164	44394	48624
CAM Data[1811]	23246	27476	31706	35936	40166	44396	48626
CAM Data[1812]	23248	27478	31708	35938	40168	44398	48628
CAM Data[1813]	23250	27480	31710	35940	40170	44400	48630
CAM Data[1814]	23252	27482	31712	35942	40172	44402	48632
CAM Data[1815]	23254	27484	31714	35944	40174	44404	48634
CAM Data[1816]	23256	27486	31716	35946	40176	44406	48636
CAM Data[1817]	23258	27488	31718	35948	40178	44408	48638
CAM Data[1818]	23260	27490	31720	35950	40180	44410	48640

Chapter 10 Internal Memory Address of “Read/Write Variable Data” command

	Block 1	Block 2	Block 3	Block 4	Block 5	Block 6	Block 7
CAM Data[1819]	23262	27492	31722	35952	40182	44412	48642
CAM Data[1820]	23264	27494	31724	35954	40184	44414	48644
CAM Data[1821]	23266	27496	31726	35956	40186	44416	48646
CAM Data[1822]	23268	27498	31728	35958	40188	44418	48648
CAM Data[1823]	23270	27500	31730	35960	40190	44420	48650
CAM Data[1824]	23272	27502	31732	35962	40192	44422	48652
CAM Data[1825]	23274	27504	31734	35964	40194	44424	48654
CAM Data[1826]	23276	27506	31736	35966	40196	44426	48656
CAM Data[1827]	23278	27508	31738	35968	40198	44428	48658
CAM Data[1828]	23280	27510	31740	35970	40200	44430	48660
CAM Data[1829]	23282	27512	31742	35972	40202	44432	48662
CAM Data[1830]	23284	27514	31744	35974	40204	44434	48664
CAM Data[1831]	23286	27516	31746	35976	40206	44436	48666
CAM Data[1832]	23288	27518	31748	35978	40208	44438	48668
CAM Data[1833]	23290	27520	31750	35980	40210	44440	48670
CAM Data[1834]	23292	27522	31752	35982	40212	44442	48672
CAM Data[1835]	23294	27524	31754	35984	40214	44444	48674
CAM Data[1836]	23296	27526	31756	35986	40216	44446	48676
CAM Data[1837]	23298	27528	31758	35988	40218	44448	48678
CAM Data[1838]	23300	27530	31760	35990	40220	44450	48680
CAM Data[1839]	23302	27532	31762	35992	40222	44452	48682
CAM Data[1840]	23304	27534	31764	35994	40224	44454	48684
CAM Data[1841]	23306	27536	31766	35996	40226	44456	48686
CAM Data[1842]	23308	27538	31768	35998	40228	44458	48688
CAM Data[1843]	23310	27540	31770	36000	40230	44460	48690
CAM Data[1844]	23312	27542	31772	36002	40232	44462	48692
CAM Data[1845]	23314	27544	31774	36004	40234	44464	48694
CAM Data[1846]	23316	27546	31776	36006	40236	44466	48696
CAM Data[1847]	23318	27548	31778	36008	40238	44468	48698
CAM Data[1848]	23320	27550	31780	36010	40240	44470	48700
CAM Data[1849]	23322	27552	31782	36012	40242	44472	48702
CAM Data[1850]	23324	27554	31784	36014	40244	44474	48704
CAM Data[1851]	23326	27556	31786	36016	40246	44476	48706
CAM Data[1852]	23328	27558	31788	36018	40248	44478	48708
CAM Data[1853]	23330	27560	31790	36020	40250	44480	48710
CAM Data[1854]	23332	27562	31792	36022	40252	44482	48712
CAM Data[1855]	23334	27564	31794	36024	40254	44484	48714
CAM Data[1856]	23336	27566	31796	36026	40256	44486	48716
CAM Data[1857]	23338	27568	31798	36028	40258	44488	48718
CAM Data[1858]	23340	27570	31800	36030	40260	44490	48720
CAM Data[1859]	23342	27572	31802	36032	40262	44492	48722
CAM Data[1860]	23344	27574	31804	36034	40264	44494	48724
CAM Data[1861]	23346	27576	31806	36036	40266	44496	48726

Chapter 10 Internal Memory Address of “Read/Write Variable Data” command

	Block 1	Block 2	Block 3	Block 4	Block 5	Block 6	Block 7
CAM Data[1862]	23348	27578	31808	36038	40268	44498	48728
CAM Data[1863]	23350	27580	31810	36040	40270	44500	48730
CAM Data[1864]	23352	27582	31812	36042	40272	44502	48732
CAM Data[1865]	23354	27584	31814	36044	40274	44504	48734
CAM Data[1866]	23356	27586	31816	36046	40276	44506	48736
CAM Data[1867]	23358	27588	31818	36048	40278	44508	48738
CAM Data[1868]	23360	27590	31820	36050	40280	44510	48740
CAM Data[1869]	23362	27592	31822	36052	40282	44512	48742
CAM Data[1870]	23364	27594	31824	36054	40284	44514	48744
CAM Data[1871]	23366	27596	31826	36056	40286	44516	48746
CAM Data[1872]	23368	27598	31828	36058	40288	44518	48748
CAM Data[1873]	23370	27600	31830	36060	40290	44520	48750
CAM Data[1874]	23372	27602	31832	36062	40292	44522	48752
CAM Data[1875]	23374	27604	31834	36064	40294	44524	48754
CAM Data[1876]	23376	27606	31836	36066	40296	44526	48756
CAM Data[1877]	23378	27608	31838	36068	40298	44528	48758
CAM Data[1878]	23380	27610	31840	36070	40300	44530	48760
CAM Data[1879]	23382	27612	31842	36072	40302	44532	48762
CAM Data[1880]	23384	27614	31844	36074	40304	44534	48764
CAM Data[1881]	23386	27616	31846	36076	40306	44536	48766
CAM Data[1882]	23388	27618	31848	36078	40308	44538	48768
CAM Data[1883]	23390	27620	31850	36080	40310	44540	48770
CAM Data[1884]	23392	27622	31852	36082	40312	44542	48772
CAM Data[1885]	23394	27624	31854	36084	40314	44544	48774
CAM Data[1886]	23396	27626	31856	36086	40316	44546	48776
CAM Data[1887]	23398	27628	31858	36088	40318	44548	48778
CAM Data[1888]	23400	27630	31860	36090	40320	44550	48780
CAM Data[1889]	23402	27632	31862	36092	40322	44552	48782
CAM Data[1890]	23404	27634	31864	36094	40324	44554	48784
CAM Data[1891]	23406	27636	31866	36096	40326	44556	48786
CAM Data[1892]	23408	27638	31868	36098	40328	44558	48788
CAM Data[1893]	23410	27640	31870	36100	40330	44560	48790
CAM Data[1894]	23412	27642	31872	36102	40332	44562	48792
CAM Data[1895]	23414	27644	31874	36104	40334	44564	48794
CAM Data[1896]	23416	27646	31876	36106	40336	44566	48796
CAM Data[1897]	23418	27648	31878	36108	40338	44568	48798
CAM Data[1898]	23420	27650	31880	36110	40340	44570	48800
CAM Data[1899]	23422	27652	31882	36112	40342	44572	48802
CAM Data[1900]	23424	27654	31884	36114	40344	44574	48804
CAM Data[1901]	23426	27656	31886	36116	40346	44576	48806
CAM Data[1902]	23428	27658	31888	36118	40348	44578	48808
CAM Data[1903]	23430	27660	31890	36120	40350	44580	48810
CAM Data[1904]	23432	27662	31892	36122	40352	44582	48812

Chapter 10 Internal Memory Address of “Read/Write Variable Data” command

	Block 1	Block 2	Block 3	Block 4	Block 5	Block 6	Block 7
CAM Data[1905]	23434	27664	31894	36124	40354	44584	48814
CAM Data[1906]	23436	27666	31896	36126	40356	44586	48816
CAM Data[1907]	23438	27668	31898	36128	40358	44588	48818
CAM Data[1908]	23440	27670	31900	36130	40360	44590	48820
CAM Data[1909]	23442	27672	31902	36132	40362	44592	48822
CAM Data[1910]	23444	27674	31904	36134	40364	44594	48824
CAM Data[1911]	23446	27676	31906	36136	40366	44596	48826
CAM Data[1912]	23448	27678	31908	36138	40368	44598	48828
CAM Data[1913]	23450	27680	31910	36140	40370	44600	48830
CAM Data[1914]	23452	27682	31912	36142	40372	44602	48832
CAM Data[1915]	23454	27684	31914	36144	40374	44604	48834
CAM Data[1916]	23456	27686	31916	36146	40376	44606	48836
CAM Data[1917]	23458	27688	31918	36148	40378	44608	48838
CAM Data[1918]	23460	27690	31920	36150	40380	44610	48840
CAM Data[1919]	23462	27692	31922	36152	40382	44612	48842
CAM Data[1920]	23464	27694	31924	36154	40384	44614	48844
CAM Data[1921]	23466	27696	31926	36156	40386	44616	48846
CAM Data[1922]	23468	27698	31928	36158	40388	44618	48848
CAM Data[1923]	23470	27700	31930	36160	40390	44620	48850
CAM Data[1924]	23472	27702	31932	36162	40392	44622	48852
CAM Data[1925]	23474	27704	31934	36164	40394	44624	48854
CAM Data[1926]	23476	27706	31936	36166	40396	44626	48856
CAM Data[1927]	23478	27708	31938	36168	40398	44628	48858
CAM Data[1928]	23480	27710	31940	36170	40400	44630	48860
CAM Data[1929]	23482	27712	31942	36172	40402	44632	48862
CAM Data[1930]	23484	27714	31944	36174	40404	44634	48864
CAM Data[1931]	23486	27716	31946	36176	40406	44636	48866
CAM Data[1932]	23488	27718	31948	36178	40408	44638	48868
CAM Data[1933]	23490	27720	31950	36180	40410	44640	48870
CAM Data[1934]	23492	27722	31952	36182	40412	44642	48872
CAM Data[1935]	23494	27724	31954	36184	40414	44644	48874
CAM Data[1936]	23496	27726	31956	36186	40416	44646	48876
CAM Data[1937]	23498	27728	31958	36188	40418	44648	48878
CAM Data[1938]	23500	27730	31960	36190	40420	44650	48880
CAM Data[1939]	23502	27732	31962	36192	40422	44652	48882
CAM Data[1940]	23504	27734	31964	36194	40424	44654	48884
CAM Data[1941]	23506	27736	31966	36196	40426	44656	48886
CAM Data[1942]	23508	27738	31968	36198	40428	44658	48888
CAM Data[1943]	23510	27740	31970	36200	40430	44660	48890
CAM Data[1944]	23512	27742	31972	36202	40432	44662	48892
CAM Data[1945]	23514	27744	31974	36204	40434	44664	48894
CAM Data[1946]	23516	27746	31976	36206	40436	44666	48896
CAM Data[1947]	23518	27748	31978	36208	40438	44668	48898

Chapter 10 Internal Memory Address of “Read/Write Variable Data” command

	Block 1	Block 2	Block 3	Block 4	Block 5	Block 6	Block 7
CAM Data[1948]	23520	27750	31980	36210	40440	44670	48900
CAM Data[1949]	23522	27752	31982	36212	40442	44672	48902
CAM Data[1950]	23524	27754	31984	36214	40444	44674	48904
CAM Data[1951]	23526	27756	31986	36216	40446	44676	48906
CAM Data[1952]	23528	27758	31988	36218	40448	44678	48908
CAM Data[1953]	23530	27760	31990	36220	40450	44680	48910
CAM Data[1954]	23532	27762	31992	36222	40452	44682	48912
CAM Data[1955]	23534	27764	31994	36224	40454	44684	48914
CAM Data[1956]	23536	27766	31996	36226	40456	44686	48916
CAM Data[1957]	23538	27768	31998	36228	40458	44688	48918
CAM Data[1958]	23540	27770	32000	36230	40460	44690	48920
CAM Data[1959]	23542	27772	32002	36232	40462	44692	48922
CAM Data[1960]	23544	27774	32004	36234	40464	44694	48924
CAM Data[1961]	23546	27776	32006	36236	40466	44696	48926
CAM Data[1962]	23548	27778	32008	36238	40468	44698	48928
CAM Data[1963]	23550	27780	32010	36240	40470	44700	48930
CAM Data[1964]	23552	27782	32012	36242	40472	44702	48932
CAM Data[1965]	23554	27784	32014	36244	40474	44704	48934
CAM Data[1966]	23556	27786	32016	36246	40476	44706	48936
CAM Data[1967]	23558	27788	32018	36248	40478	44708	48938
CAM Data[1968]	23560	27790	32020	36250	40480	44710	48940
CAM Data[1969]	23562	27792	32022	36252	40482	44712	48942
CAM Data[1970]	23564	27794	32024	36254	40484	44714	48944
CAM Data[1971]	23566	27796	32026	36256	40486	44716	48946
CAM Data[1972]	23568	27798	32028	36258	40488	44718	48948
CAM Data[1973]	23570	27800	32030	36260	40490	44720	48950
CAM Data[1974]	23572	27802	32032	36262	40492	44722	48952
CAM Data[1975]	23574	27804	32034	36264	40494	44724	48954
CAM Data[1976]	23576	27806	32036	36266	40496	44726	48956
CAM Data[1977]	23578	27808	32038	36268	40498	44728	48958
CAM Data[1978]	23580	27810	32040	36270	40500	44730	48960
CAM Data[1979]	23582	27812	32042	36272	40502	44732	48962
CAM Data[1980]	23584	27814	32044	36274	40504	44734	48964
CAM Data[1981]	23586	27816	32046	36276	40506	44736	48966
CAM Data[1982]	23588	27818	32048	36278	40508	44738	48968
CAM Data[1983]	23590	27820	32050	36280	40510	44740	48970
CAM Data[1984]	23592	27822	32052	36282	40512	44742	48972
CAM Data[1985]	23594	27824	32054	36284	40514	44744	48974
CAM Data[1986]	23596	27826	32056	36286	40516	44746	48976
CAM Data[1987]	23598	27828	32058	36288	40518	44748	48978
CAM Data[1988]	23600	27830	32060	36290	40520	44750	48980
CAM Data[1989]	23602	27832	32062	36292	40522	44752	48982
CAM Data[1990]	23604	27834	32064	36294	40524	44754	48984

Chapter 10 Internal Memory Address of “Read/Write Variable Data” command

	Block 1	Block 2	Block 3	Block 4	Block 5	Block 6	Block 7
CAM Data[1991]	23606	27836	32066	36296	40526	44756	48986
CAM Data[1992]	23608	27838	32068	36298	40528	44758	48988
CAM Data[1993]	23610	27840	32070	36300	40530	44760	48990
CAM Data[1994]	23612	27842	32072	36302	40532	44762	48992
CAM Data[1995]	23614	27844	32074	36304	40534	44764	48994
CAM Data[1996]	23616	27846	32076	36306	40536	44766	48996
CAM Data[1997]	23618	27848	32078	36308	40538	44768	48998
CAM Data[1998]	23620	27850	32080	36310	40540	44770	49000
CAM Data[1999]	23622	27852	32082	36312	40542	44772	49002
CAM Data[2000]	23624	27854	32084	36314	40544	44774	49004
CAM Data[2001]	23626	27856	32086	36316	40546	44776	49006
CAM Data[2002]	23628	27858	32088	36318	40548	44778	49008
CAM Data[2003]	23630	27860	32090	36320	40550	44780	49010
CAM Data[2004]	23632	27862	32092	36322	40552	44782	49012
CAM Data[2005]	23634	27864	32094	36324	40554	44784	49014
CAM Data[2006]	23636	27866	32096	36326	40556	44786	49016
CAM Data[2007]	23638	27868	32098	36328	40558	44788	49018
CAM Data[2008]	23640	27870	32100	36330	40560	44790	49020
CAM Data[2009]	23642	27872	32102	36332	40562	44792	49022
CAM Data[2010]	23644	27874	32104	36334	40564	44794	49024
CAM Data[2011]	23646	27876	32106	36336	40566	44796	49026
CAM Data[2012]	23648	27878	32108	36338	40568	44798	49028
CAM Data[2013]	23650	27880	32110	36340	40570	44800	49030
CAM Data[2014]	23652	27882	32112	36342	40572	44802	49032
CAM Data[2015]	23654	27884	32114	36344	40574	44804	49034
CAM Data[2016]	23656	27886	32116	36346	40576	44806	49036
CAM Data[2017]	23658	27888	32118	36348	40578	44808	49038
CAM Data[2018]	23660	27890	32120	36350	40580	44810	49040
CAM Data[2019]	23662	27892	32122	36352	40582	44812	49042
CAM Data[2020]	23664	27894	32124	36354	40584	44814	49044
CAM Data[2021]	23666	27896	32126	36356	40586	44816	49046
CAM Data[2022]	23668	27898	32128	36358	40588	44818	49048
CAM Data[2023]	23670	27900	32130	36360	40590	44820	49050
CAM Data[2024]	23672	27902	32132	36362	40592	44822	49052
CAM Data[2025]	23674	27904	32134	36364	40594	44824	49054
CAM Data[2026]	23676	27906	32136	36366	40596	44826	49056
CAM Data[2027]	23678	27908	32138	36368	40598	44828	49058
CAM Data[2028]	23680	27910	32140	36370	40600	44830	49060
CAM Data[2029]	23682	27912	32142	36372	40602	44832	49062
CAM Data[2030]	23684	27914	32144	36374	40604	44834	49064
CAM Data[2031]	23686	27916	32146	36376	40606	44836	49066
CAM Data[2032]	23688	27918	32148	36378	40608	44838	49068
CAM Data[2033]	23690	27920	32150	36380	40610	44840	49070

Chapter 10 Internal Memory Address of “Read/Write Variable Data” command

	Block 1	Block 2	Block 3	Block 4	Block 5	Block 6	Block 7
CAM Data[2034]	23692	27922	32152	36382	40612	44842	49072
CAM Data[2035]	23694	27924	32154	36384	40614	44844	49074
CAM Data[2036]	23696	27926	32156	36386	40616	44846	49076
CAM Data[2037]	23698	27928	32158	36388	40618	44848	49078
CAM Data[2038]	23700	27930	32160	36390	40620	44850	49080
CAM Data[2039]	23702	27932	32162	36392	40622	44852	49082
CAM Data[2040]	23704	27934	32164	36394	40624	44854	49084
CAM Data[2041]	23706	27936	32166	36396	40626	44856	49086
CAM Data[2042]	23708	27938	32168	36398	40628	44858	49088
CAM Data[2043]	23710	27940	32170	36400	40630	44860	49090
CAM Data[2044]	23712	27942	32172	36402	40632	44862	49092
CAM Data[2045]	23714	27944	32174	36404	40634	44864	49094
CAM Data[2046]	23716	27946	32176	36406	40636	44866	49096
CAM Data[2047]	23718	27948	32178	36408	40638	44868	49098

10.7 User CAM data memory address

	Axis1	Axis2	Axis3	Axis4
Number of user CAM data	49100	49222	49344	49466
Main axis position1	49102	49224	49346	49468
Sub axis position1	49104	49226	49348	49470
Main axis position 2	49106	49228	49350	49472
Sub axis position 2	49108	49230	49352	49474
Main axis position 3	49110	49232	49354	49476
Sub axis position 3	49112	49234	49356	49478
Main axis position 4	49114	49236	49358	49480
Sub axis position 4	49116	49238	49360	49482
Main axis position 5	49118	49240	49362	49484
Sub axis position 5	49120	49242	49364	49486
Main axis position 6	49122	49244	49366	49488
Sub axis position 6	49124	49246	49368	49490
Main axis position 7	49126	49248	49370	49492
Sub axis position 7	49128	49250	49372	49494
Main axis position 8	49130	49252	49374	49496
Sub axis position 8	49132	49254	49376	49498
Main axis position 9	49134	49256	49378	49500
Sub axis position 9	49136	49258	49380	49502
Main axis position 10	49138	49260	49382	49504
Sub axis position 10	49140	49262	49384	49506
Main axis position 11	49142	49264	49386	49508
Sub axis position 11	49144	49266	49388	49510
Main axis position 12	49146	49268	49390	49512
Sub axis position 12	49148	49270	49392	49514
Main axis position 13	49150	49272	49394	49516
Sub axis position 13	49152	49274	49396	49518
Main axis position 14	49154	49276	49398	49520
Sub axis position 14	49156	49278	49400	49522
Main axis position 15	49158	49280	49402	49524
Sub axis position 15	49160	49282	49404	49526
Main axis position 16	49162	49284	49406	49528
Sub axis position 16	49164	49286	49408	49530

Chapter 10 Internal Memory Address of “Read/Write Variable Data” command

	Axis1	Axis2	Axis3	Axis4
Main axis position 17	49166	49288	49410	49532
Sub axis position 17	49168	49290	49412	49534
Main axis position 18	49170	49292	49414	49536
Sub axis position 18	49172	49294	49416	49538
Main axis position 19	49174	49296	49418	49540
Sub axis position 19	49176	49298	49420	49542
Main axis position 20	49178	49300	49422	49544
Sub axis position 20	49180	49302	49424	49546
Main axis position 21	49182	49304	49426	49548
Sub axis position 21	49184	49306	49428	49550
Main axis position 22	49186	49308	49430	49552
Sub axis position 22	49188	49310	49432	49554
Main axis position 23	49190	49312	49434	49556
Sub axis position 23	49192	49314	49436	49558
Main axis position 24	49194	49316	49438	49560
Sub axis position 24	49196	49318	49440	49562
Main axis position 25	49198	49320	49442	49564
Sub axis position 25	49200	49322	49444	49566
Main axis position 26	49202	49324	49446	49568
Sub axis position 26	49204	49326	49448	49570
Main axis position 27	49206	49328	49450	49572
Sub axis position 27	49208	49330	49452	49574
Main axis position 28	49210	49332	49454	49576
Sub axis position 28	49212	49334	49456	49578
Main axis position 29	49214	49336	49458	49580
Sub axis position 29	49216	49338	49460	49582
Main axis position 30	49218	49340	49462	49584
Sub axis position 30	49220	49342	49464	49586

Part 4. Embedded Analog

Chapter 1. Embedded Analog Function

Part 3 describes the analog input and output function which is embedded in ultimate performance XBC basic unit.

1.1 Setting Sequence before Operation

Before using the analog input and output function, follow steps below.

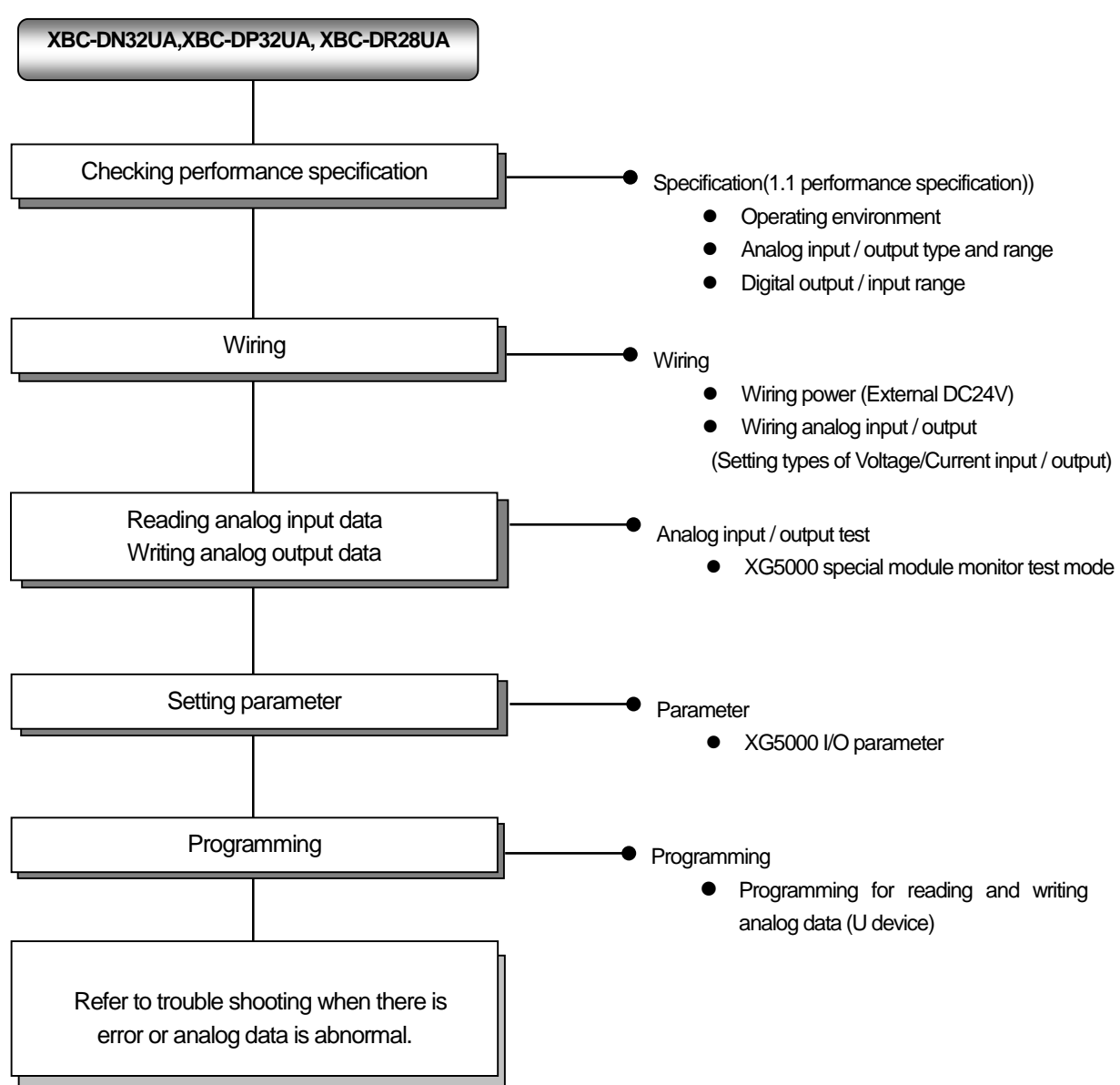

Performance specifications are as follows.

(1) Input performance specification

Items		Performance specification	
Number of channels		4 channels	
Analog input	Type	Voltage	Current
	Range	DC 1 ~ 5V DC 0 ~ 5V DC 0 ~ 10V DC -10 ~ 10V (Input resistance: 1 M Ω)	DC 4 ~ 20mA DC 0 ~ 20mA (Input resistance 250 Ω)
		Current input or Voltage input can be selected through the external terminal wiring setting. ▶ In voltage mode, use V+ and COM terminal for the channel. In current mode, short V+ and I+ terminal and then use I+ and COM terminal.	
Digital output Range	Unsigned value	0 ~ 16000	
	Signed value	-8000 ~ 8000	
	Precise value	1000 ~ 5000 (1 ~ 5V) 0 ~ 5000 (0 ~ 5V) 0 ~ 10000 (0 ~ 10V) -10000 ~ 10000 (\pm 10V)	4000 ~ 20000 (4 ~ 20mA) 0 ~ 20000 (0 ~ 20mA)
		Percentile value	0 ~ 10000
Max. resolution	1/16000		
	0.250mV (1 ~ 5V) 0.3125mV (0 ~ 5V) 0.625mV (0 ~ 10V) 1.250mV (\pm 10V)	1.0 μ A (4 ~ 20mA) 1.25 μ A (0 ~ 20mA)	
Accuracy	\pm 0.2% or less (When ambient temperature 25 $^{\circ}$ C) \pm 0.3% or less (When ambient temperature 0 ~ 55 $^{\circ}$ C)		
Max. conversion speed	0.5ms/channel		
Absolute max. input	DC \pm 15V	DC \pm 30mA	
Additional function	Filter	Digital filter (4~64,000ms)	
	Average	Time average (4~16,000ms)	
		Count average (2~64,000 $\bar{\sigma}$)	
		Moving average (2~100 $\bar{\sigma}$)	
		Weighted average (1~99%)	
	Detection alarm	Disconnection(DC 1~5V, DC 4~20mA)	
	Hold last value	When input signal exceeds the effective range, holds the last effective value.	
Alarm function	When input signal exceeds the effective range, relevant flag turns on.		
input terminal	12 point terminal block		

(2) Output performance specification

Items		Performance specification	
Channels		4 channels (Voltage 2 channels, Current 2 channels)	
Analog output range	Type	Voltage	Current
	Range	DC 1 ~ 5V DC 0 ~ 5V DC 0 ~ 10V DC -10 ~ 10V (Load resistance: 1k Ω or more)	DC 4 ~ 20mA DC 0 ~ 20mA (Load resistance: 600 Ω or less)
	Output ranges are set in user program or I/O parameter per each channel.		
Digital input	Range	Unsigned value	0 ~ 16,000
		Signed value	-8,000 ~ 8,000
		Precise value	1,000 ~ 5,000 (1 ~ 5V) 0 ~ 5,000 (0 ~ 5V) 0 ~ 10,000 (0 ~ 10V) -10,000 ~ 10,000 (\pm 10V)
		Percentile value	0 ~ 10,000
Max. resolution		1/16,000	
		0.250mV (1 ~ 5V) 0.3125mV (0 ~ 5V) 0.625mV (0 ~ 10V) 1.250mV (\pm 10V)	1.0 μ A (4 ~ 20mA) 1.25 μ A (0 ~ 20mA)
Accuracy		\pm 0.2% or less (When ambient temperature is 25 $^{\circ}$ C) \pm 0.3% or less (When ambient temperature is 0 ~ 55 $^{\circ}$ C)	
Max. conversion speed		0.5ms/ channel	
Additional function		Setting of channel output status (Select one among previous, Min, Max value) Setting of interpolation method (Linear interpolation, S-type interpolation)	
Insulation method		Photo-coupler insulation between output terminal and PLC power (no insulation between channels)	
Output terminal		12 point terminal	

(3) Input and output common performance specification

Items		Performance specification
Insulation method		insulation between input / output terminal and PLC power (no insulation between channels)
Power supply		DC 24V
I/O occupied points		Fixed point assignment: 64 points
Current consumption	Internal(DC 5V)	100mA
	External(DC 24V)	250mA

1.2 Name of Each Part and Functions

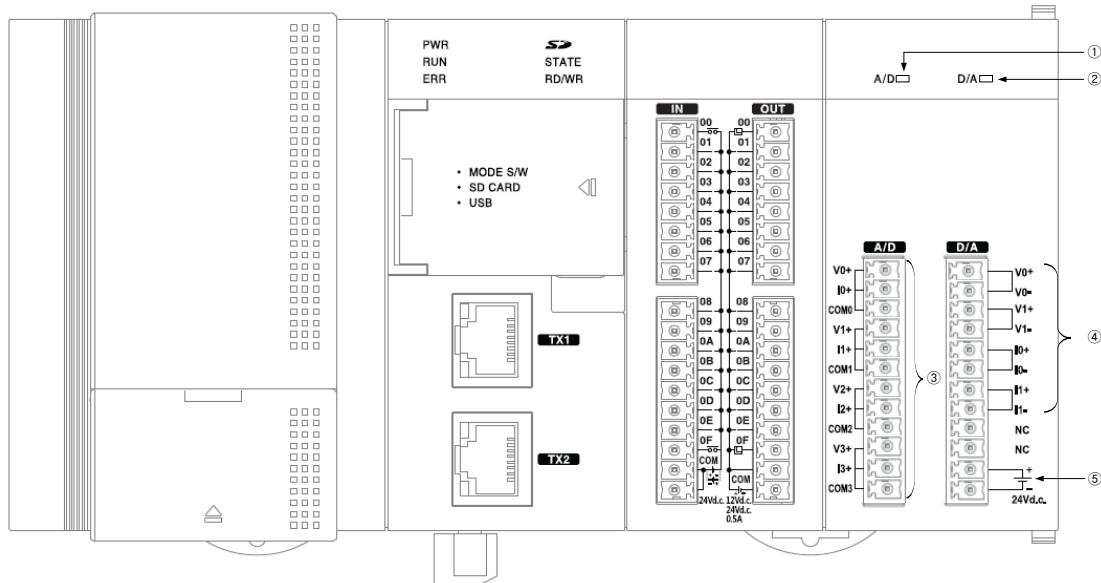

No.	Name	Description
①	AD LED	<ul style="list-style-type: none"> ▶ Displays the operation status of analog input part On: Operation normal Blinks: Error occurs (Flickering 1s intervals) Off: Power off or module error
②	DA LED	<ul style="list-style-type: none"> ▶ Displays the operation status of analog output part On: Operation normal Blinks: Error occurs (Flickering 1s intervals) Off: Power off or module error
③	Input terminal	<ul style="list-style-type: none"> ▶ Wiring input terminal block to connect with external device
④	Output terminal	<ul style="list-style-type: none"> ▶ Wiring output terminal block to connect with external device
⑤	External Power supply	<ul style="list-style-type: none"> ▶ Terminal for supplying the external DC24V ▶ Blinks AD, DA LEDs simultaneously when DC24V is not supplied. (Flickering 0.4s intervals)

1.3 Characteristic of I/O Conversion

Voltage/Current input ranges are able to set from each channel by using user program or I/O parameter. Data output type of digital is defined as below.

- (1) Unsigned Value
- (2) Signed Value
- (3) Precise Value
- (4) Percentile Value

1.3.1 Input Characteristic

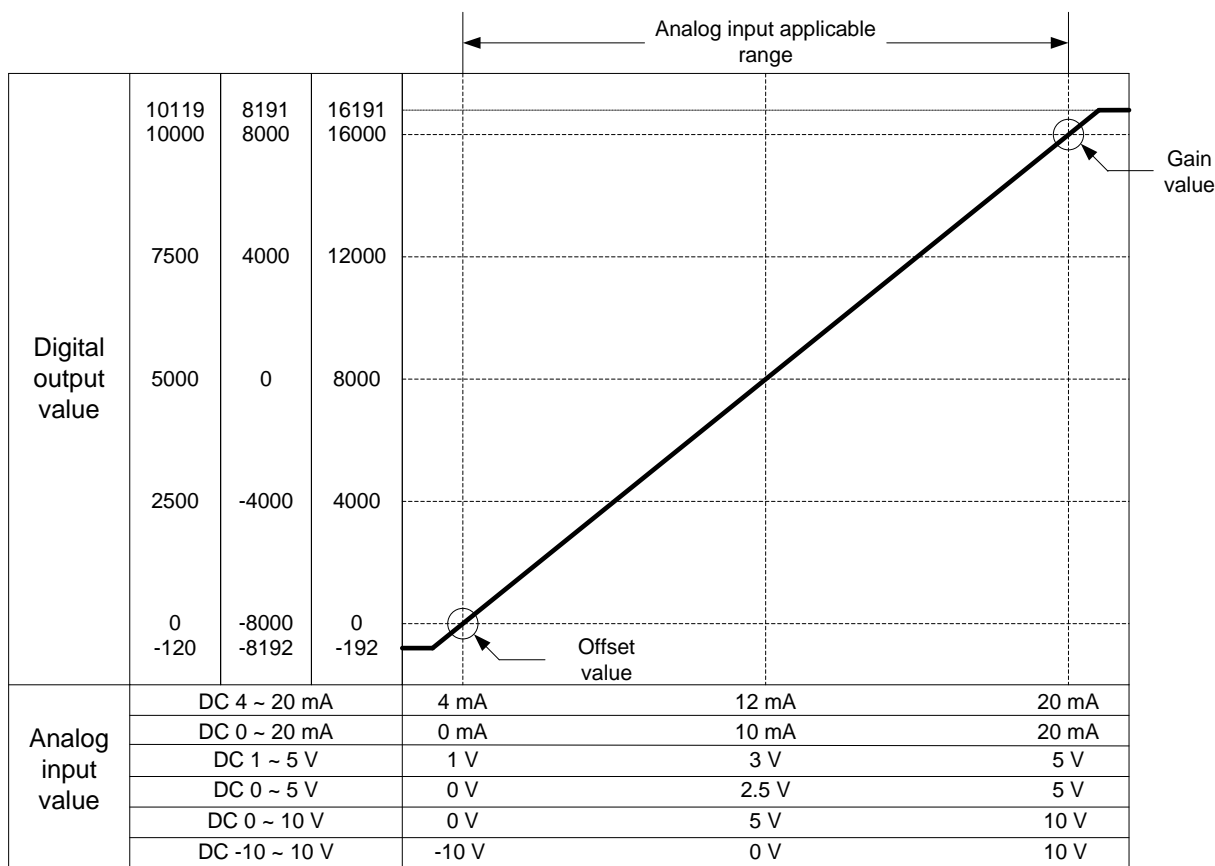

(1) DC 4 ~ 20mA Input range

Digital output range	Analog input current (mA)						
	3.808	4	8	12	16	20	20.191
Unsigned value (-192 ~ 16191)	-192	0	4,000	8,000	12,000	16,000	16,191
Signed value (-8192 ~ 8191)	-8,192	-8,000	-4,000	0	4,000	8,000	8,191
Precise value (3808 ~ 20191)	3,808	4,000	8,000	12,000	16,000	20,000	20,191
Percentile value (-120 ~ 10119)	-120	0	2,500	5,000	7,500	10,000	10,119

(2) DC 0 ~ 20mA Input range

Digital output range	Analog input current (mA)						
	-0.24	0	5	10	15	20	20.239
Unsigned value (-192 ~ 16191)	-192	0	4,000	8,000	12,000	16,000	16,191
Signed value (-8192 ~ 8191)	-8,192	-8,000	-4,000	0	4,000	8,000	8,191
Precise value (-240 ~ 20239)	-240	0	5,000	10,000	15,000	20,000	20,239
Percentile value (-120 ~ 10119)	-120	0	2,500	5,000	7,500	10,000	10,119

(3) DC 1 ~ 5V Input range

Digital output range	Analog input voltage (V)						
	0.952	1	2	3	4	5	5.047
Unsigned Value (-192 ~ 16,191)	-192	0	4,000	8,000	12,000	16,000	16,191
Signed Value (-8,192 ~ 8,191)	-8,192	-8,000	-4,000	0	4,000	8,000	8,191
Precise Value (952 ~ 5,047)	952	1,000	2,000	3,000	4,000	5,000	5,047
Percentile Value (-120 ~ 10,119)	-120	0	2,500	5,000	7,500	10,000	10,119

(4) DC 0 ~ 5V Input range

Digital output range	Analog input voltage (V)						
	-0.06	0	1.25	2.5	3.75	5	5.059
Unsigned Value (-192 ~ 16,191)	-192	0	4,000	8,000	12,000	16,000	16,191
Signed Value (-8,192 ~ 8,191)	-8,192	-8,000	-4,000	0	4,000	8,000	8,191
Precise Value (-60 ~ 5,059)	-60	0	1,250	2,500	3,750	5,000	5,059
Percentile Value (-120 ~ 10,119)	-120	0	2,500	5,000	7,500	10,000	10,119

(5) DC 0 ~ 10V Input range

Digital output range	Analog input voltage (V)						
	-0.12	0	2.5	5	7.5	10	10.119
Unsigned Value (-192 ~ 16,191)	-192	0	4,000	8,000	12,000	16,000	16,191
Signed Value (-8,192 ~ 8,191)	-8,192	-8,000	-4,000	0	4,000	8,000	8,191
Precise Value (-120 ~ 10,119)	-120	0	2,500	5,000	7,500	10,000	10,119
Percentile Value (-120 ~ 10,119)	-120	0	2,500	5,000	7,500	10,000	10,119

(6) DC -10 ~ 10V Input range

Digital output range	Analog input voltage (V)						
	-10.24	-10	-5	0	5	10	10.239
Unsigned Value (-192 ~ 16,191)	-192	0	4,000	8,000	12,000	16,000	16,191
Signed Value (-8,192 ~ 8,191)	-8,192	-8,000	-4,000	0	4,000	8,000	8,191
Precise Value (-10,240 ~ 10,239)	-10,240	-10,000	-5,000	0	5,000	10,000	10,239
Percentile Value (-120 ~ 10,119)	-120	0	2,500	5,000	7,500	10,000	10,119

1.3.2 Output Characteristic

1) Conversion characteristic of analog output(Voltage)

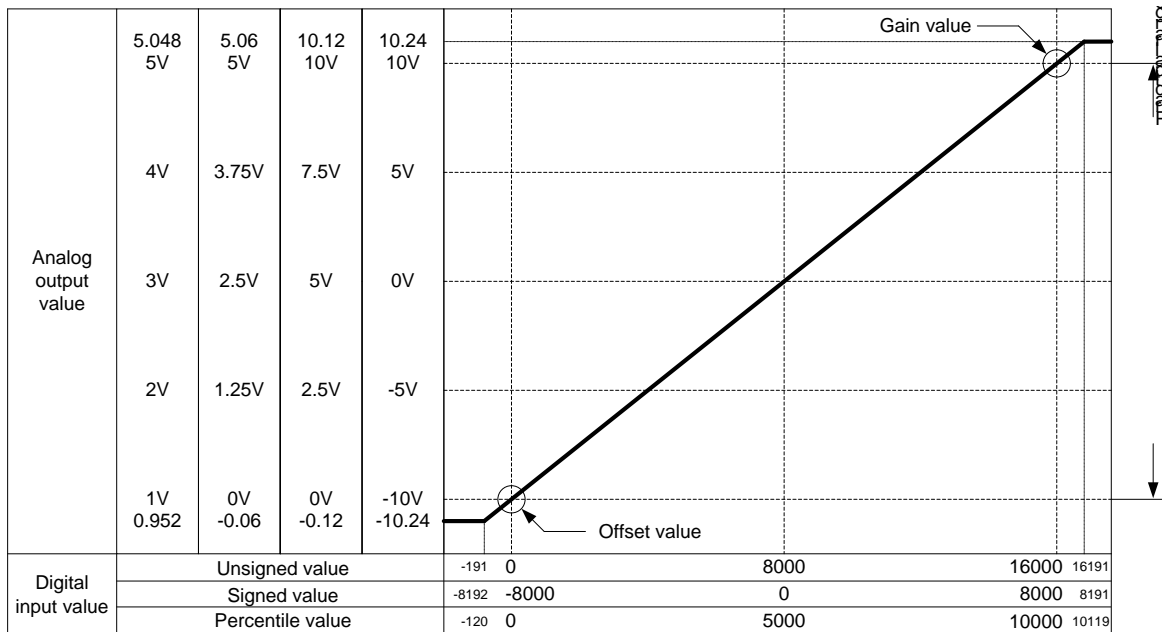

(1) DC 1 ~ 5V Output range

Digital input	Analog output voltage (V)						
	0.952	1	2	3	4	5	5.047
Unsigned value (-192 ~ 16,191)	-192	0	4,000	8,000	12,000	16,000	16,191
Signed value (-8,192 ~ 8,191)	-8,192	-8,000	-4,000	0	4,000	8,000	8,191
Precise value (952 ~ 5,047)	952	1,000	2,000	3,000	4,000	5,000	5,047
Percentile value (-120 ~ 10,119)	-120	0	2,500	5,000	7,500	10,000	10,119

(2) DC 0 ~ 5V Output range

Digital value	Analog output voltage (V)						
	-0.06	0	1.25	2.5	3.75	5	5.059
Unsigned value (-192 ~ 16,191)	-192	0	4,000	8,000	12,000	16,000	16,191
Signed value (-8,192 ~ 8,191)	-8,192	-8,000	-4,000	0	4,000	8,000	8,191
Precise value (-60 ~ 5,059)	-60	0	1,250	2,500	3,750	5,000	5,059
Percentile value (-120 ~ 10,119)	-120	0	2,500	5,000	7,500	10,000	10,119

(3) DC 0 ~ 10V Output range

Digital input	Analog output voltage (V)						
	-0.12	0	2.5	5	7.5	10	10.119
Unsigned value (-192 ~ 16,191)	-192	0	4,000	8,000	12,000	16,000	16,191
Signed value (-8,192 ~ 8,191)	-8,192	-8,000	-4,000	0	4,000	8,000	8,191
Precise value (-120 ~ 10,119)	-120	0	2,500	5,000	7,500	10,000	10,119
Percentile value (-120 ~ 10,119)	-120	0	2,500	5,000	7,500	10,000	10,119

(4) DC -10 ~ 10V Output range

Digital input	Analog output voltage (V)						
	-10.24	-10	-5	0	5	10	10.239
Unsigned value (-192 ~ 16,191)	-192	0	4,000	8,000	12,000	16,000	16,191
Signed value (-8,192 ~ 8,191)	-8,192	-8,000	-4,000	0	4,000	8,000	8,191
Precise value (-10,240 ~ 10,239)	-10,240	-10,000	-5,000	0	5,000	10,000	10,239
Percentile value (-120 ~ 10,119)	-120	0	2,500	5,000	7,500	10,000	10,119

2) Conversion characteristic of analog output(Current)

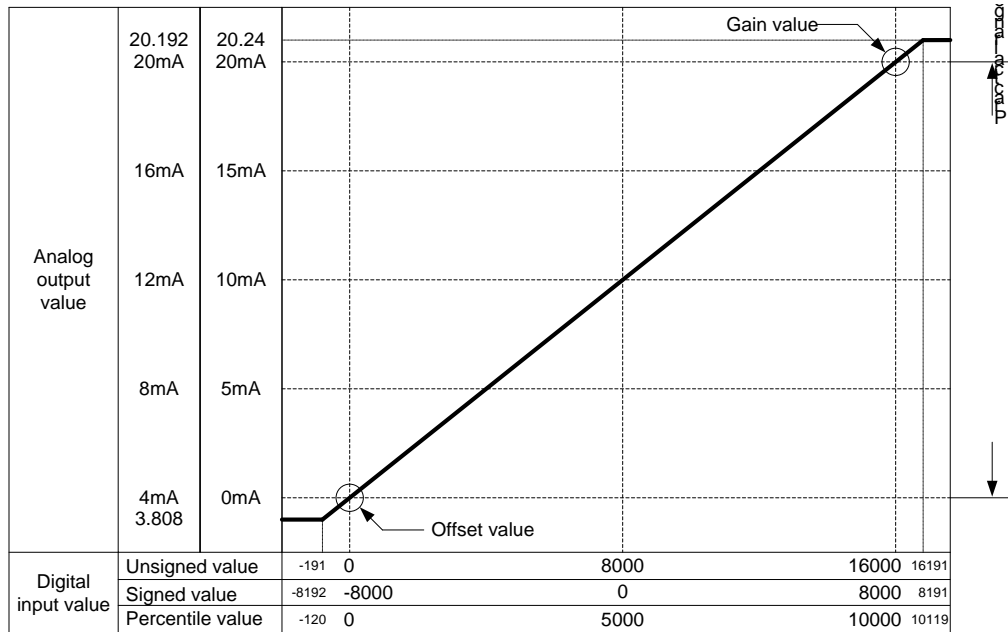

(1) DC 4 ~ 20mA Output range

Digital input range	Analog output current (mA)						
	3.808	4	8	12	16	20	20.191
Unsigned value (-192 ~ 16,191)	-192	0	4,000	8,000	12,000	16,000	16,191
Signed value (-8,192 ~ 8,191)	-8,192	-8,000	-4,000	0	4,000	8,000	8,191
Precise value (3,808 ~ 20,191)	3,808	4,000	8,000	12,000	16,000	20,000	20,191
Percentile value (-120 ~ 10,119)	-120	0	2,500	5,000	7,500	10,000	10,119

(2) DC 0 ~ 20mA Output range

Digital input range	Analog output current (mA)						
	-	0	5	10	15	20	20.239
Unsigned value (0 ~ 16,191)	-	0	4,000	8,000	12,000	16,000	16,191
Signed value (-8,000 ~ 8,191)	-	-8,000	-4,000	0	4,000	8,000	8,191
Precise value (0 ~ 20,239)	-	0	5,000	10,000	15,000	20,000	20,239
Percentile value (0 ~ 10,119)	-	0	2,500	5,000	7,500	10,000	10,119

1.4 Accuracy

1.4.1 Input Accuracy

Accuracy of digital output value does not change even if input range is changed. Figure below shows the range of the accuracy with analog input range of 0 ~ 10 V and digital output type of unsigned value selected.

Accuracy is $\pm 0.2\%$. (ambient temperature of 25 degrees)

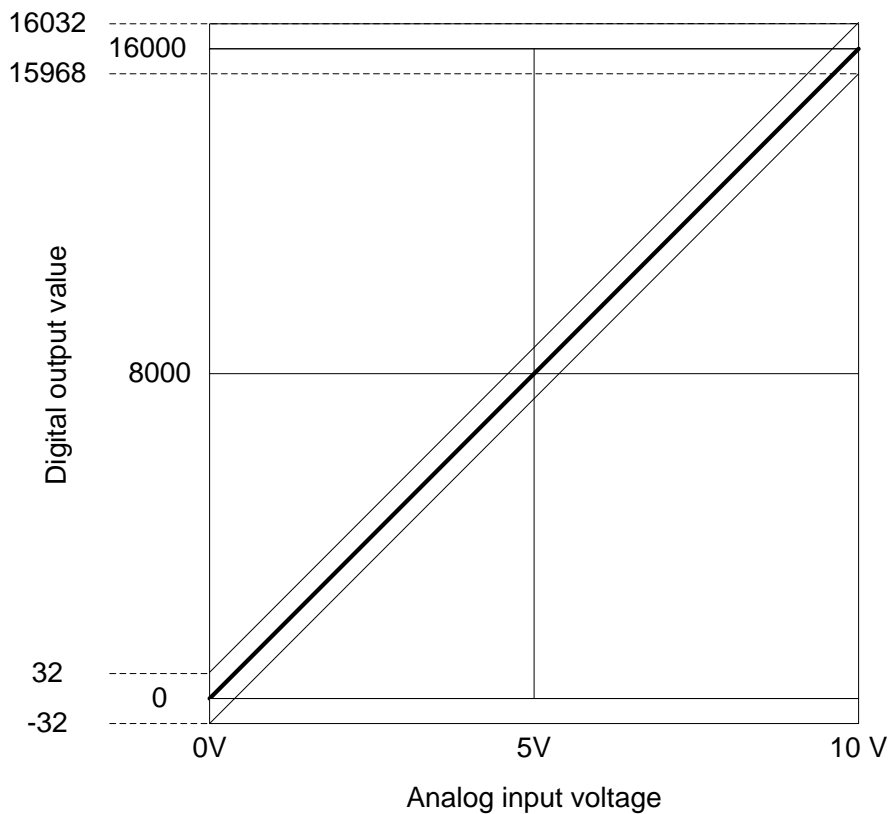

(1) Accuracy when using 5V input

$$16,000 \times 0.2\% = 32$$

Therefore the range of the accuracy will become $(8,000-32) \sim (8,000+32) = 7,968 \sim 8,032$ when using 5V input.

(2) Accuracy when using 10V input

$$16,000 \times 0.2\% = 32$$

Therefore the range of the accuracy will become $(16,000-32) \sim (16,000+32) = 15,968 \sim 16,032$ when using 10V input.

1.4.2 Output Accuracy

Accuracy of digital output value does not change even if input range is changed. When digital input range is selected with unsigned value, accuracy is $\pm 0.2\%$ (Ambient temperature of $25 \pm 5 \text{ }^\circ\text{C}$)

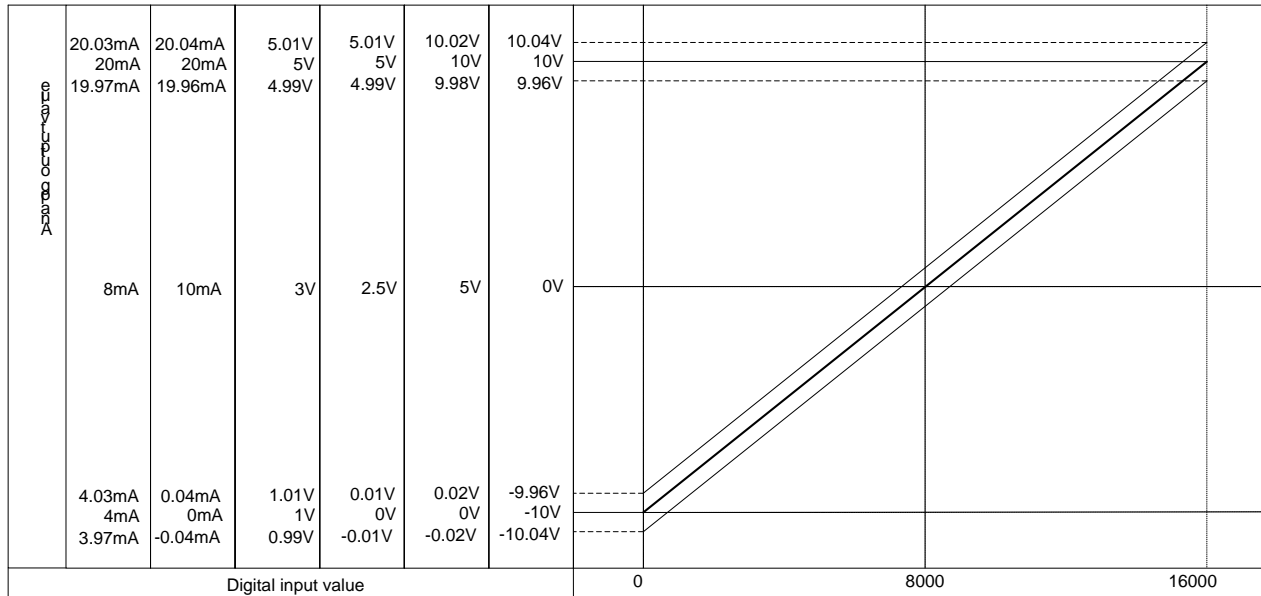

(1) Accuracy when using -10~10V output

$$16000 \times 0.2\% = 32$$

Accuracy range when using -10V output will become

$$(-10V - 32 \times 1.25\text{mV}) \sim (-10V + 32 \times 1.25\text{mV}) = -10.04 \sim -9.96\text{V},$$

Accuracy range when using 10V output will become

$$(10V - 32 \times 1.25\text{mV}) \sim (10V + 32 \times 1.25\text{mV}) = 9.96 \sim 10.04\text{V}$$

(2) Accuracy when using 4~20mA output

$$16000 \times 0.2\% = 32$$

Accuracy range when using 4mA output will become

$$(4\text{mA} - 32 \times 1\mu\text{A}) \sim (4\text{mA} + 32 \times 1\mu\text{A}) = 3.97\text{mA} \sim 4.03\text{mA}$$

Accuracy range when using 20mA output will become

$$(20\text{mA} - 32 \times 1\mu\text{A}) \sim (20\text{mA} + 32 \times 1\mu\text{A}) = 19.97\text{mA} \sim 20.03\text{mA}$$

1.5 Embedded Functions

Functions of embedded analog module are as described below.

Function	Description
Channel Run/Stop setting	<ul style="list-style-type: none"> Specify Run/Stop of the channel to execute A/D, D/A conversion. If the unused channel is set to Stop, whole Run time can be reduced.
Input / output voltage/current range setting	<ul style="list-style-type: none"> Specify analog input / output range to be used. Select range in parameter setting after selecting Voltage/Current input / output according to the wiring properly. Embedded analog module provides two kinds of current input / output ranges (4~20mA, 0~20mA) and four kinds of voltage input / output ranges (1~5V, 0~5V, 0~10V,-10~10V)
Input / output data format setting	<ul style="list-style-type: none"> Specify digital input / output type. 4 data formats are provided in this module. (Unsigned value, Signed value, Precise value, Percentile value)
A/D conversion methods	<ul style="list-style-type: none"> Sampling processing <ul style="list-style-type: none"> - Sampling process will be performed if A/D conversion type is not specified. Filter processing <ul style="list-style-type: none"> - Used to delay the sudden change of input value. Average processing <ul style="list-style-type: none"> - Outputs average A/D conversion value based on time or count. Detection alarm (Input disconnection) <ul style="list-style-type: none"> - After detecting whether disconnection of the input circuit, the alarm is displayed by a single flag. (Input signal range : 4 ~ 20mA, 1 ~ 5 V) Maintenance function of valid conversion value. <ul style="list-style-type: none"> - When valid conversion value is exceeded, whether conversion value retains will be able to set. Alarm function <ul style="list-style-type: none"> - When exceeding valid input range, alarm and maximum /minimum flag will be generated.
D/A output status setting	<ul style="list-style-type: none"> Set the output status of channel when changing 'Run' to 'Stop'. The four kinds of output statuses (Previous, Min, Mid, Max value) are provided.
Interpolation method setting	<ul style="list-style-type: none"> Set linear interpolation, S-type interpolation method.
Detecting output disconnection	<ul style="list-style-type: none"> Detection alarm (Output disconnection) <ul style="list-style-type: none"> - After detecting whether disconnection of the output circuit, the alarm is displayed by a single flag. (Output signal range : 4 ~ 20mA, 0 ~ 20mA)

1.5.1 Sampling Processing

It collects analog input sign through general A/D conversion processing at a specific interval to convert to digital. The time required for A/D conversion of analog input sign till saved on the memory depends on the number of channels used.

$$\text{(Processing time)} = \text{(Number of channels used)} \times \text{(Conversion speed)}$$

(i.e.) If the number of channels used is 3, its process time will be

$$3 \times 0.5 \text{ ms} = 1.5 \text{ ms}$$

Sampling is to calculate the sampling value of continuous analog sign at a specific interval.

1.5.2 Filter Processing

Pre-filter input value and specified channel are calculated as below.

$$\text{Filtered Value} = \frac{(\text{Pre - Filtered Input Value} \times \text{Filter Constant}) + (\text{Current Input Value} \times 1\text{ms} \times \text{Number of used channels})}{\text{Filter Constant} + (1\text{ms} \times \text{Number of used channels})}$$

Setting range of Filter constant = 4 ~ 64,000 [ms]

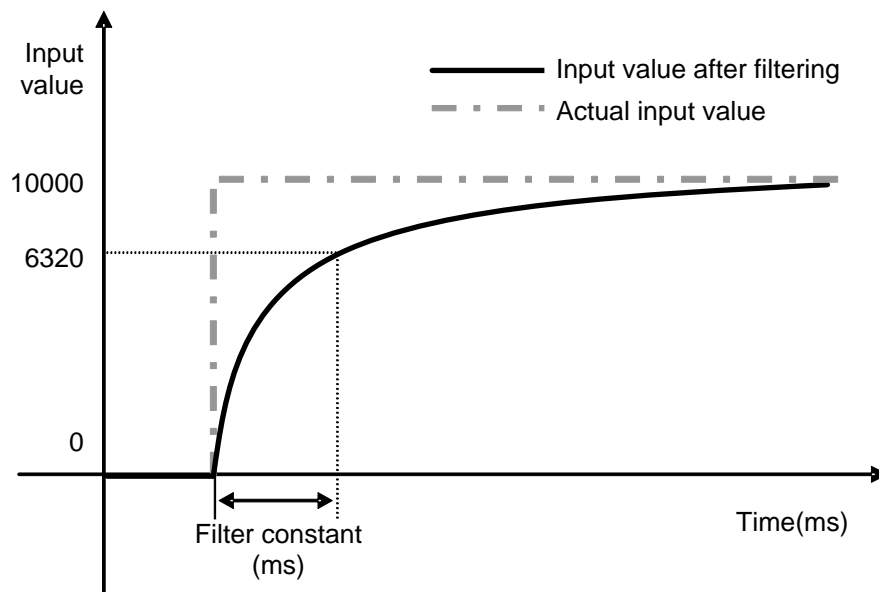

As the above graph, if the input value rapidly decreases from 0 to 10,000, the input value will be filtered. Specified time with filter constant is that the input value is the time to change by 63.2% of actual time constant.

1.5.3 Average Processing

(1) Time Average

Input value of specified channel accumulates during setting time and then the average value of the sum is shown with digital data.

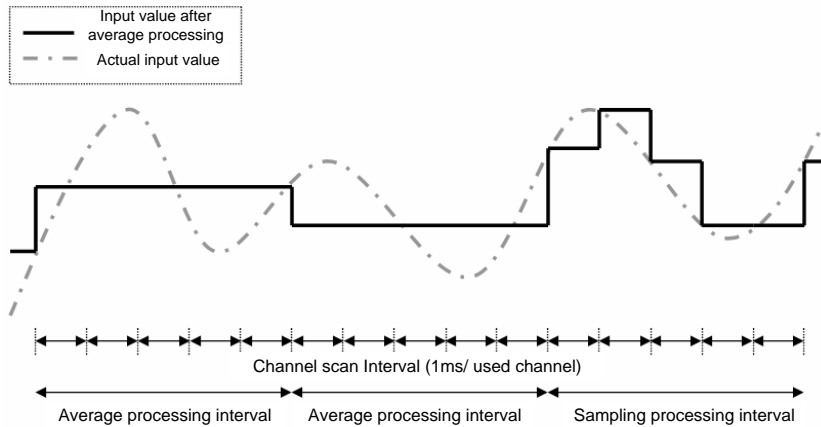

Setting range = 4 ~ 16,000 [ms]

In case of the time average, the average processing count is calculated by depending on the number of used channels.

$$\text{Average processing count} = \frac{\text{Average time}}{\text{Number of used channels} \times 0.5\text{ms}}$$

Time average is converted to count average in A/D conversion module internally, and then processed. In this case, remainder can be generated when dividing average time by (number of used channels X 0.5ms). The remainder is rounded down.

(i.e.) If the number of channels used is 4 and setting time is 151ms,

$$\text{Average processing count} = 151 \text{ ms} \div (4 \times 0.5\text{ms}) = 75 \text{ counts} \cdots \text{remainder } 1 \rightarrow 75 \text{ counts}$$

(2) Count Average

Input value of specified channel accumulates during setting numbers and then the average value of the sum is shown with digital data

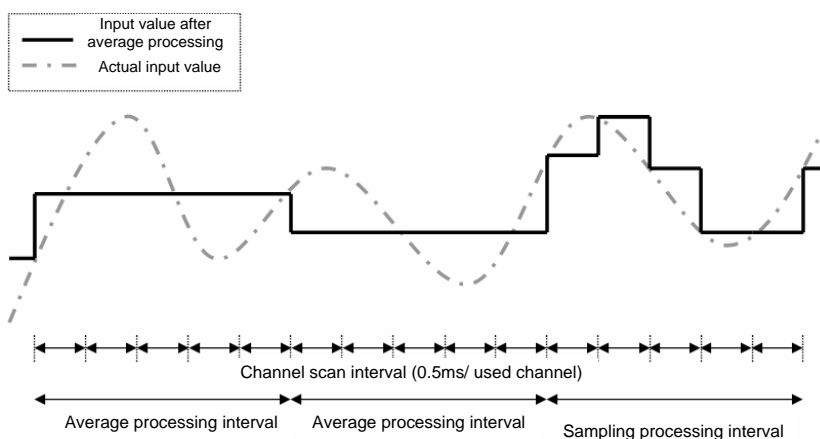

Setting range = 2 ~ 64000 [times]

In case of count average, the average processing interval is calculated by depending on used channels.

$$\text{Average processing interval [ms]} = \text{Number of average count} \times \text{Number of used channels} \times 0.5\text{ms}$$

(3) Moving Average

The inputs into the designated channel are accumulated for the presser number, and its average is calculated and outputted in digital data. However, in moving average method, each scan provides its average value.

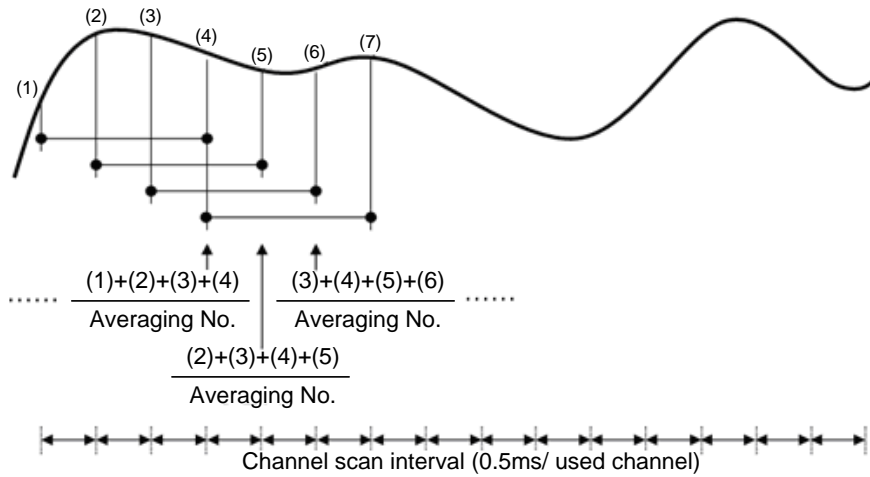

(4) Weighted Average

Weighted average function processes transition of input data gradually by filter(delay) of input sampling data.

Setting range: 1 ~ 99(%)

$$F[n] = (1 - \alpha) \times A[n] + \alpha \times F[n - 1]$$

$F[n]$: Current Weighted average output
 $A[n]$: Current A/D Conversion value
 $F[n - 1]$: Former Weighted average output
 α : Weighted average constant
 (0.01 ~ 0.99 : Weighted value of former value)

Setting Value	Filter Output Value				설명
	-	Scan 1	Scan 2	Scan 3	
No Setting	0	8000	8000	8000	Not process weighted average
1	0	7920	7999	7999	Apply 1% of former value
50	0	4000	6000	7000	Apply 50% of former value
99	0	80	159	237	Apply 99% of former value

Notes

- (1) In case of the time/number of average, every conversion time input value is not outputted. And precondition is retained until the average time/number is arrived.
- (2) Four kinds of average functions and introduced filtering functions that are above are able to deal with at the same time. When those are chosen at the same time, the top priority is filter function in the processing sequence. And then the chosen average function is adapted. Finally, digital data is outputted. At that time digital data value is outputted as the final processing value.
- (3) Number of used channel include input/output channel.

1.5.4 Detection Alarm (Input Disconnection)

In case that Input voltage(DC 1~5V) or Input current (DC 4~20 mA) is chosen with analog input range, the analog input module has diagnostic function by checking disconnection and showing. If the module shows disconnection, that means the parts of connections in the wiring connection are faulty. If so, check and take action.

(1) Detection conditions

When input signal range of 4~20mA and 1~5V is used, disconnection of input circuit can be detected. The detection conditions of each input signal range are as below.

Input signal range	Voltage/Current recognized as a disconnection
4 ~ 20 mA	0.8 mA or less
1 ~ 5 V	0.2 V or less

(2) When between used wiring and module is disconnected, the LED will be turned on/off 1s intervals.

(3) Each channel can detect disconnection. However, Disconnection is only displayed for specified operation channel. The LED can commonly use the channel from 0 to 3. If one or more channel is disconnected, LED will be turned on/off.

Input connections	Channel operation	AD LED condition	Disconnection flag
Normal	Operation	On	Off
	Stop	On	Off
Input wiring is disconnected or Input is not connected.	Operation	Flickering (1s intervals)	On
	Stop	On	Off

(4) In case of disconnection, disconnection flag of relevant channel will turn on and In case of connection, disconnection flag of relevant channel will turn off.

Disconnection flag		Description	Condition
U01.07.0	%UX0.1.112	Channel 0 disconnection	Off: Normal On: Disconnection
U01.07.1	%UX0.1.113	Channel 1 disconnection	
U01.07.2	%UX0.1.114	Channel 2 disconnection	
U01.07.3	%UX0.1.115	Channel 3 disconnection	

(5) In case of disconnection, the input value displays the lowest value among each input range.

1.5.5 Hold Last Value Function

When input signal exceeds the effective range, last input value is held. This function can be set for each channel by I/O parameter setting or user program.

1) Used input range

In the channels that allow the hold last value function, the actual ranges provided within each digital conversion value are shown. For example, in case of operating output data type of unsigned value, original digital output value is shown from -192 to 16,191. However, if this function is allowed, it will be shown from 0 to 16,000. It is recommended that the function should be setting when the input value is in the actual range.

(1) Digital output value depending on input range (unsigned value, signed value, percentile value)

Classification	Unsigned value	Signed value	Precise value	Percentile value
Function disabled	-192~16191	-8192~8191	(2) Reference	-120~10119
Function enabled	0~16000	-8000~8000		0~10000

(2) Digital output value depending on input range (Precise value)

Analog input range	Classification	Precise value
4 ~ 20mA	Function disabled	3808~20191
	Function enabled	4000~20000
0 ~ 20mA	Function disabled	-240~20239
	Function enabled	0~20000
1 ~ 5V	Function disabled	952~5047
	Function enabled	1000~5000
0 ~ 5V	Function disabled	-60~5059
	Function enabled	0~5000
0 ~ 10V	Function disabled	-120~10119
	Function enabled	0~10000
-10 ~ 10V	Function disabled	-10240~10239
	Function enabled	-10000~10000

2) Operation

When operating with 4 ~ 20mA while being enabled this function, output value for input value change of the moment is as follows. (Output data type : In case of 0~16,000)

Input current(mA)	12mA	3mA	4mA	12mA	21mA	20mA
Digital output value	8000	8000	0	8000	8000	16000
Remarks	-	Hold last value	-	-	Hold last value	-

1.5.6 Alarm Function

When the input signal is exceeded from valid value, the alarm will be shown through alarm flag of relevant channel.

1) Input detection condition

Detection condition for each input signal range is as follows.

Analog input range	Signal Difference	Permission range	Lower limit	Upper limit
4 ~ 20mA	16mA	1.2%	3.808mA	20.192mA
0 ~ 20mA	20mA		-0.24mA	20.24mA
1 ~ 5V	4V		0.952V	5.048V
0 ~ 5V	5V		-0.06V	5.06V
0 ~ 10V	10V		-0.12V	10.12V
-10 ~ 10V	20V		-10.24V	10.24V

2) Alarm indication for each channel

Alarm detection signal is shown on U01.08 and U01.09. If input signal returns to the within of effective range, alarm detection signal also returns to the normal status automatically.

(1) Upper limit alarm

Deviceassignment		Description	Status description
U01.08.0	%UX0.1.128	CH0 upper limit alarm	Off: Normal On: Maximum alarm occurrence
U01.08.1	%UX0.1.129	CH1 upper limit alarm	
U01.08.2	%UX0.1.130	CH2 upper limit alarm	
U01.08.3	%UX0.1.131	CH3 upper limit alarm	

(2) Lower limit alarm

Deviceassignment		Description	Status description
U01.09.0	%UX0.1.144	CH0 lower limit alarm	Off: Normal On: Minimum alarm occurrence
U01.09.1	%UX0.1.145	CH1 lower limit alarm	
U01.09.2	%UX0.1.146	CH2 lower limit alarm	
U01.09.3	%UX0.1.147	CH3 lower limit alarm	

Notes

The channel conversion data will be 0 and Lower limit alarm flag will be ON if the input signal is out of the effective range as below when the input channel is enabled and hold last value function is enabled.

Analog input range	Hold last value function	Input signal	Lower limit alarm	Channel conversion value
4 ~ 20mA	On	3.808mA ~ 4mA	On	0
		20mA ~ 20.192mA		
0 ~ 20mA	On	-0.24mA ~ 0mA	On	0
		20mA ~ 20.24mA		
1 ~ 5V	On	0.952V ~ 1V	On	0
		5V ~ 5.048V		
0 ~ 5V	On	-0.06V ~ 0V	On	0
		5V ~ 5.06V		
0 ~ 10V	On	-0.12V ~ 0V	On	0
		10V ~ 10.12V		
-10 ~ 10V	On	-10.24V ~ -10V	On	0
		10V ~ 10.24V		

1.5.7 Setting Function of Channel Output Status

Set the output against stop and abnormal condition of PLC.

1) Function

When initialization of module and error of PLC system are happened, use to prevent abnormal output.

2) Type

You can set an output status of channel among Previous, Min, Mid, Max value.

- (1) Previous value: The last output operated normally is retained.
- (2) Min: The Min value of each range is outputted.
- (3) Mid: The Mid value of each range is outputted.
- (4) Max: The Max value of each range is outputted.

3) Example

When the range of output channel is set by 4 ~ 20mA and the output is 10mA, and then If the system is changed from 'Run' to 'Stop', the output will be as follows depending on setting data of channel output status.

- (1) Previous value: 10mA which is previous output value is retained.
- (2) Min value: 4mA which is min value of relevant range is outputted.
- (3) Mid value: 12mA which is mid value of relevant range is outputted
- (4) Max value: 20mA which is max value of relevant range is outputted.

1.5.8 Interpolation Method Setting

1) Functions

The output signal of module is used in order to execute interpolation output depending on set interpolation time. When the voltage and current is outputted, it can be used to prevent transient response of load system as a suddenly changed output.

2) Interpolation method setting

Interpolation method can set the one among interpolation prohibition, linear interpolation S-type interpolation.

(1) Interpolation prohibition : It doesn't execute interpolation operation. And it outputs digital input value intactly.

(2) Linear interpolation : The output is changed up to objective value with linear during the interpolation time.

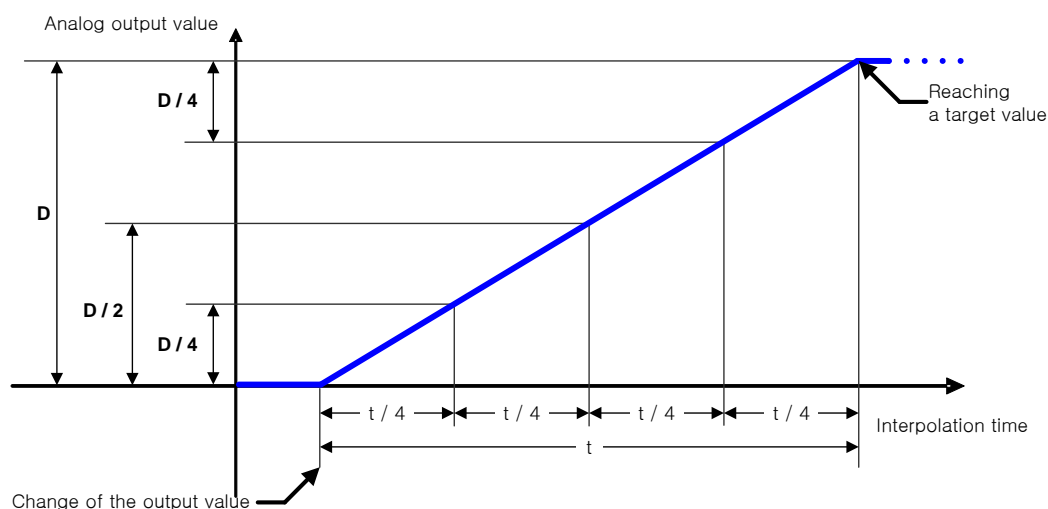

(3) S-type interpolation : The output is changed up to objective value with S-type during the interpolation time.

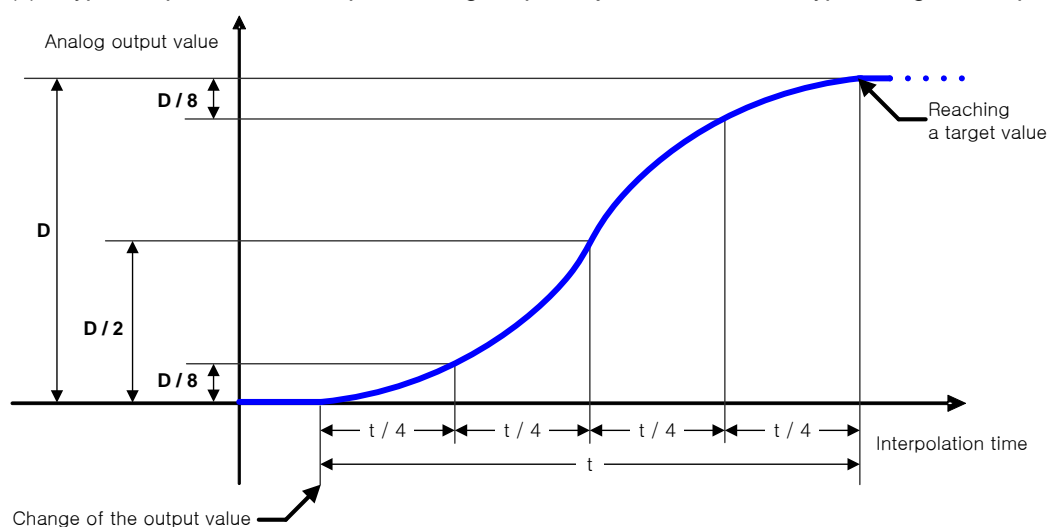

3) Interpolation time setting

The interpolation time can be set with the one among 10[ms], 100[ms], 1[s], 60[s].

The output is changed depending on interpolation method setting during the set interpolation time.

4) Interpolation output value

The interpolation operation value that is currently being outputted can check in parameter area (Address No. 20 ~ 23) while using interpolation function.

Address of interpolation output value	Details
No. 20	Voltage Channel 0 interpolation operation value
No. 21	Voltage Channel 1 interpolation operation value
No. 22	Current Channel 0 interpolation operation value
No. 23	Current Channel 1 interpolation operation value

5) Interpolation flag turns on while the interpolation is outputted. And when the interpolation output value is reached at objective value, it will turn off.

Interpolation flag	Details
U01.07.8	%UX0.1.120 Voltage Channel 0 interpolation output in operation
U01.07.9	%UX0.1.121 Voltage Channel 1 interpolation output in operation
U01.07.A	%UX0.1.122 Current Channel 0 interpolation output in operation
U01.07.B	%UX0.1.123 Current Channel 1 interpolation output in operation

※ Interpolation flag can be monitored when interpolation time is set to 1[s] or 60[s].

6) Example

The interpolation method is set to S-type interpolation and interpolation time is set to 60s. If the output is changed from 4mA to 20mA, and then changed to 4mA again when it is reached to 20mA, the output is as graph below.

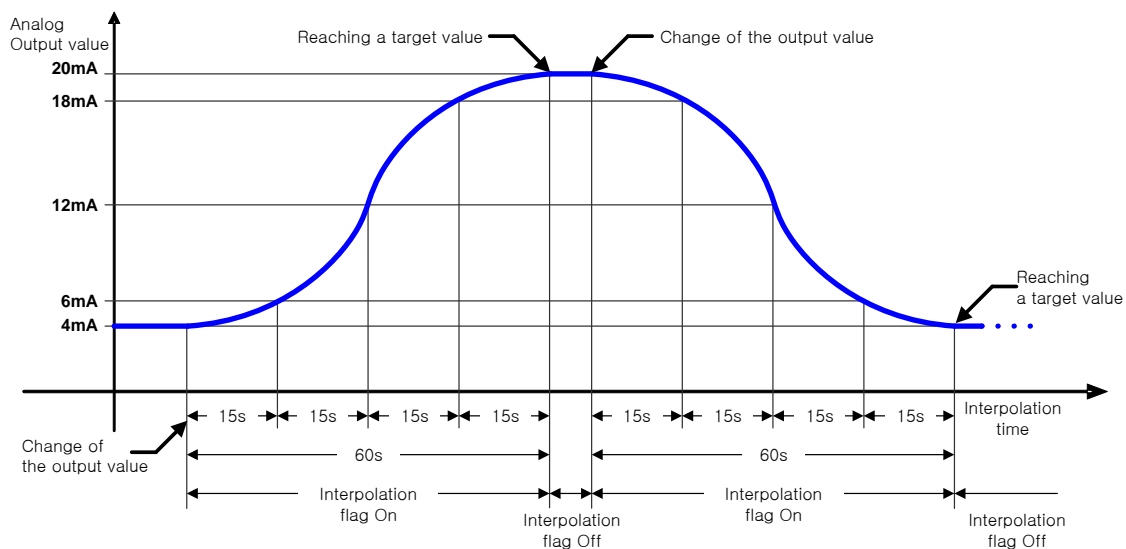

Notes

- 1) During the interpolation output, If the internal parameter is changed, the interpolation operation will be temporarily stopped and the output can be immediately changed to objective value.
- 2) If the change of internal parameter is needed, change the parameter during interpolation output after the flag turns off when the analog output value is not changed.

1.5.9 Disconnection Detecting Function (Only for Current Output)

If the analog current output module detects disconnection of output, it can show the status of module.

In case that the module checks the disconnection and it is shown as the disconnection status, there are faulty in parts of wiring connection paths. Please check and take action.

- 1) In case that the disconnection between used output wiring and module is caused, LED flickers 1s intervals and makes an error flag.
- 2) The disconnection can be detected per each channel only for designed channels for operation. LED can be used from channel 0 to 3 in common. If the one channel or more is disconnected, flickering will be generated.

Output connections	Channel operation	LED condition	Disconnection flag
Normal	Operation	On	Off
	Stop	On	Off
Output wiring is disconnected or Output is not connected	Operation	Flickering (1s intervals)	On
	Stop	On	Off

- 3) If the disconnection is happened, disconnection flag of relevant channel will be turned on. However, if the disconnection is changed to connection, the disconnection flag will be turned off.

Disconnection flag		Details
U01.07.E	UX0.1.126	Current Output Channel 0 Disconnection
U01.07.F	UX0.1.127	Current Output Channel 1 Disconnection

Notes

- 1) When the disconnection is happened, it takes several seconds until the disconnection flag is turned on.

1.6 Wiring

1.6.1 Example for Wiring Analog Input

- (1) The input resistance of current input circuit is 250Ω (typ.).
- (2) The input resistance of voltage input circuit is $1\text{ M}\Omega$ or more.
- (3) Set the operation mode only if you want to use channels.
- (4) The analog input module doesn't provide the power for input device.
Use the external power device.
- (5) Example for analog input wiring

When inputting the voltage, relevant channel V+ and COM terminal is used. When inputting the current, relevant channel V+ and COM terminal is used after connecting between V+ and I+ terminal.

(a) Voltage wiring

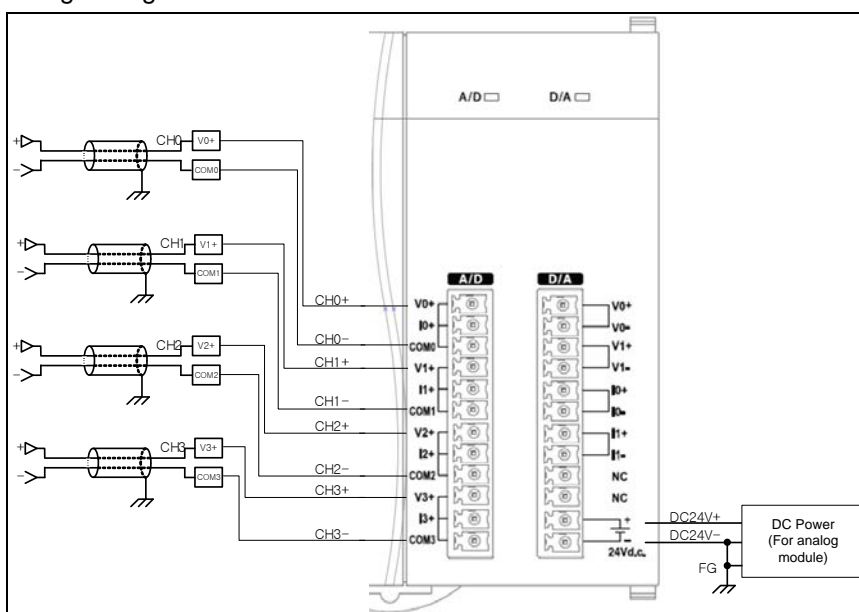

(b) Current wiring

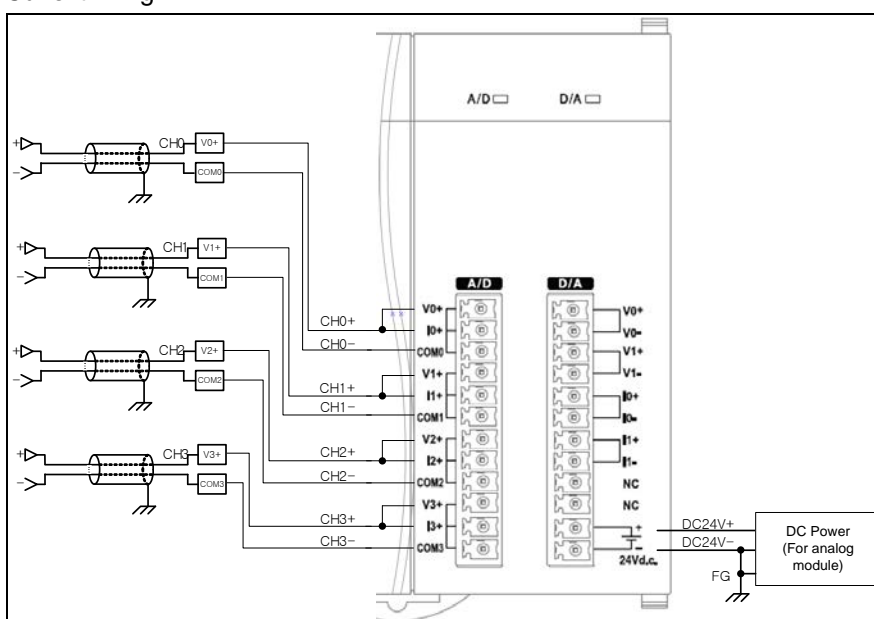

(6) The example of analog input 2-Wire sensor/transmitter wiring(The current input)
Use the I+ and COM terminal after connecting V+ with I+ terminal.

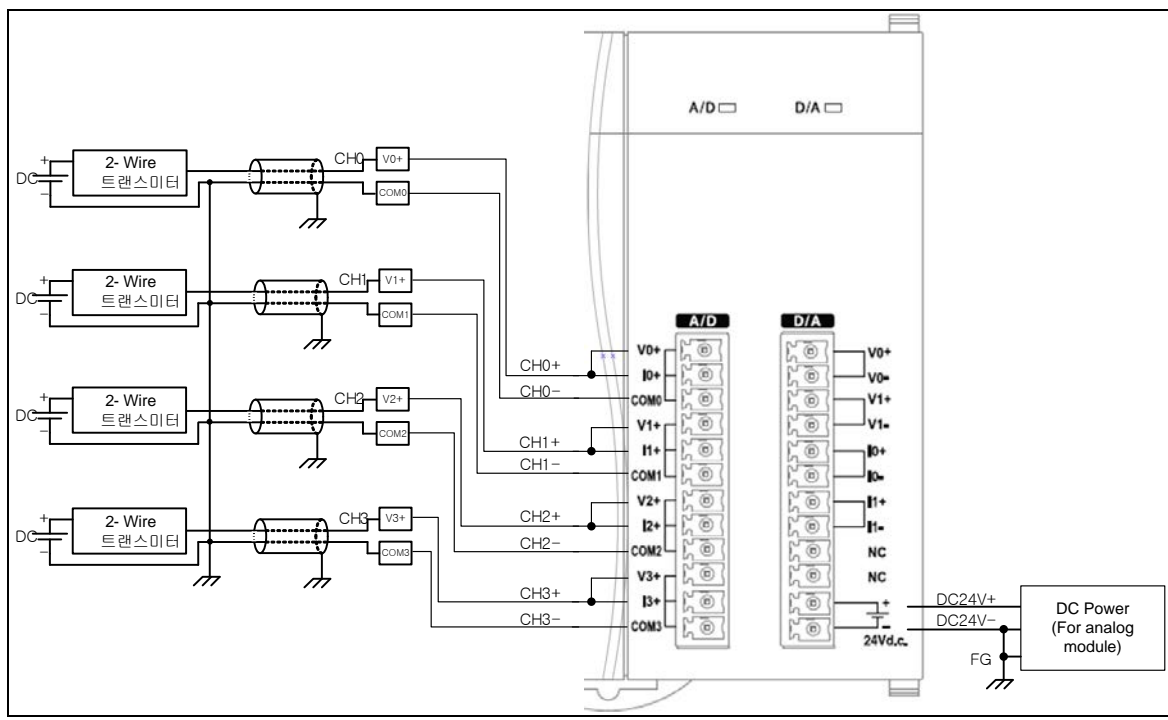

※ DC power for analog power supply have to connect DC24V- with FG.

(7) The example of analog input 4-Wire sensor/transmitter wiring(The current input)
Use the I+ and COM terminal after connecting V+ with I+ terminal.

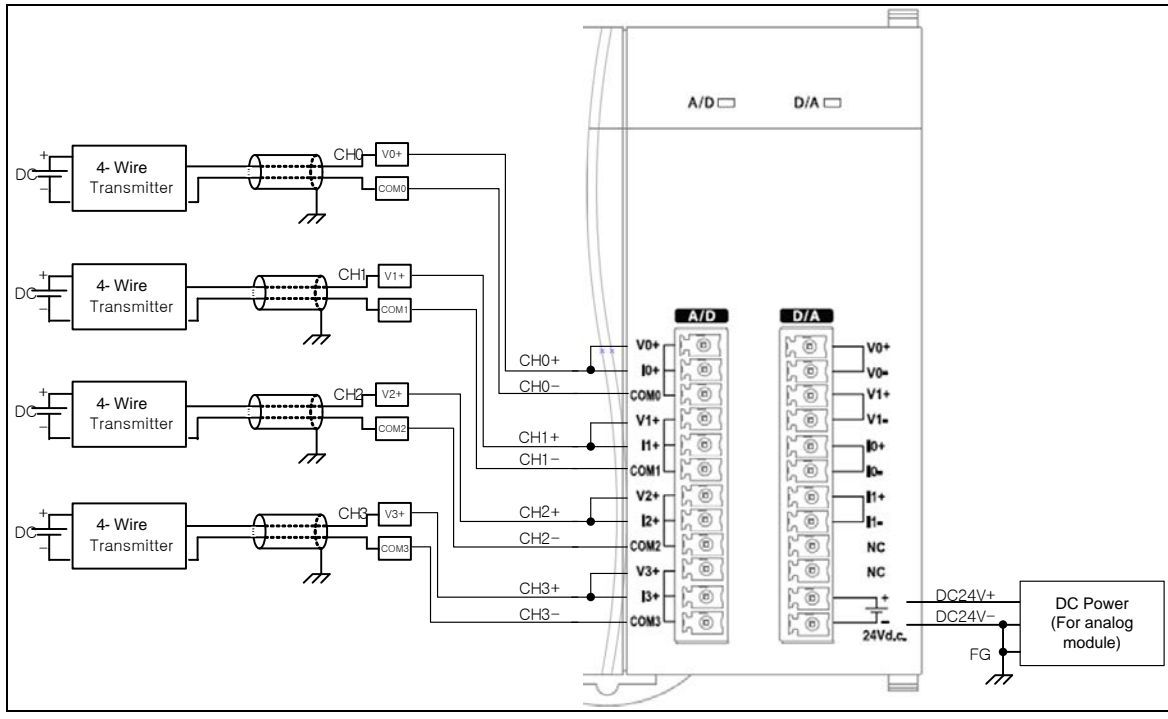

※ DC power for analog power supply have to connect DC24V- with FG.

(8) Relationship between voltage input accuracy and wiring length

In voltage input, the wiring (cable) length between transmitter or sensor and module has an effect on digital-converted values of the module as specified below;

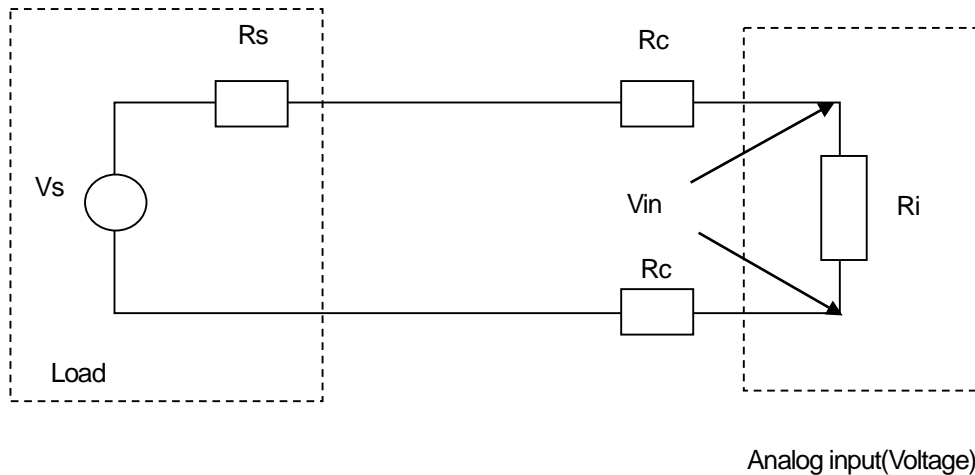

Where,

R_c : Resistance value due to line resistance of cable

R_s : Internal resistance value of transmitter or sensor

R_i : Internal resistance value ($1\text{ M}\Omega$) of voltage input module

V_{in} : Voltage allowed to analog input module

% V_i : Tolerance of converted value (%) due to source and cable length in voltage input

$$V_{in} = \frac{R_i \times V_s}{R_s + (2 \times R_c) + R_i}$$

$$\% V_i = \left(1 - \frac{V_{in}}{V_s}\right) \times 100\%$$

Notes

1) While using a input voltage range among 1~5V, 0~5V, 0~10V, -10~10V

If the external wiring is disconnected, It will take a certain amount of time to display output data value of 0V. If you want to reduce that time, connect the resistance about $0.1\text{ M}\Omega \sim 1\text{ M}\Omega$ between input channel $V+$ and COM.

1.6.2 Example for Wiring Analog Output

(1) Example for analog voltage-current output wiring

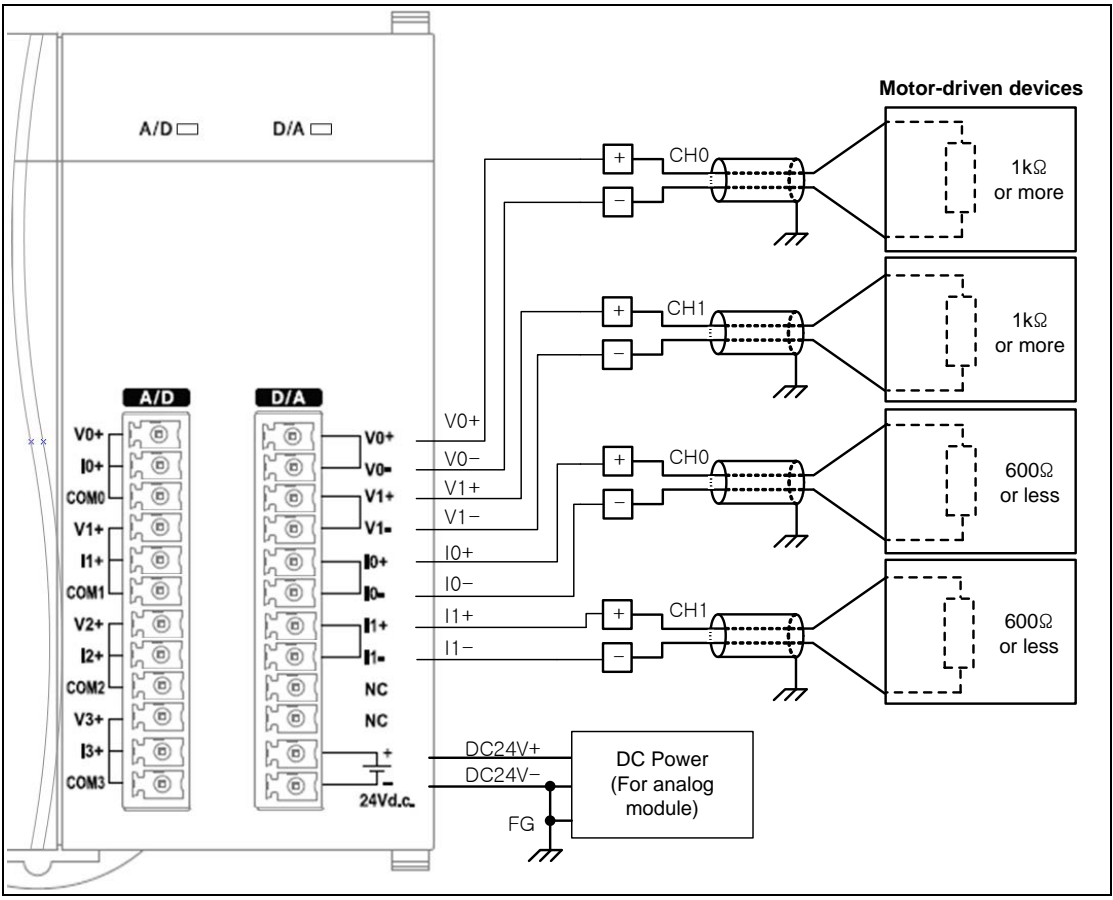

- ※1: Two-core twisted shield wire should be used as wire.
- ※2: DC power for analog power supply has to connect DC24V- with FG.

1.7 Operation Parameter Setting

Embedded analog conversion module's operation parameters can be specified through XG5000's [I/O parameters].

1) Settings

For the user's convenience of D/A conversion module, XG5000 provides GUI (Graphical User Interface) for parameters setting of D/A conversion module. Setting items available through [I/O parameters] on the XG5000 project window are as described below in the table.

Item	Details
[I/O parameter]	<p>(a) Input parameter setting Specify the following setting items necessary for the module operation.</p> <ol style="list-style-type: none"> 1) Channel Enable/Disable setting 2) Input voltage(current) range 3) Output data format setting 4) Filter constant setting 5) Average processing method setting 6) Average value setting 7) Hold last value setting <p>(b) Output parameter setting Specify the following setting items necessary for the module operation.</p> <ol style="list-style-type: none"> 1) Channel Enable/Disable setting 2) Output (voltage· current) range 3) Input data format setting 4) Channel output status setting 5) Interpolation method setting 6) Interpolation time <p>(c) When the parameters set by user in XG5000 is downloaded, that data is saved in flash memory of XGB basic unit .</p>

2) [I/O Parameter] Using method

- (1) Run XG5000 to create a project.
(Refer to XG5000 program manual for details on how to create the project)
- (2) Double-click [I/O parameters] on the project window.

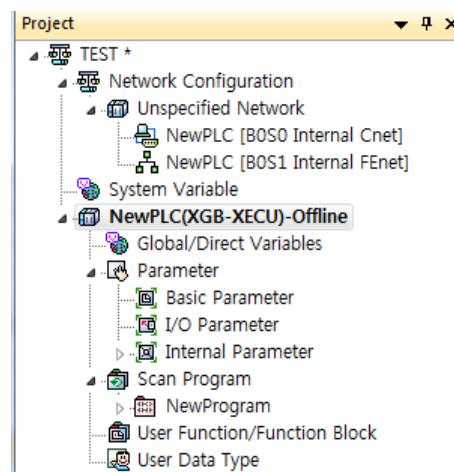

(3) [I/O Parameter setting] On the 'I/O Parameter setting' screen, find and click the slot 1(internal) which has embedded function.

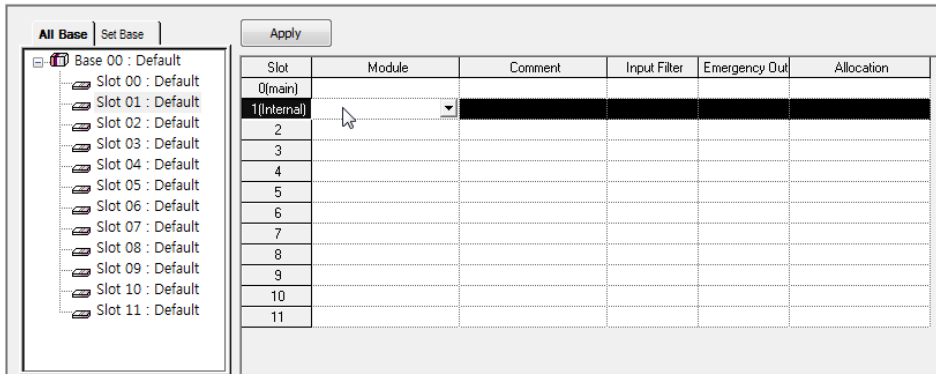

(4) Click the arrow button on the screen above to display the screen where an applicable module can be selected. Search and select the embedded analog input/output module to select.

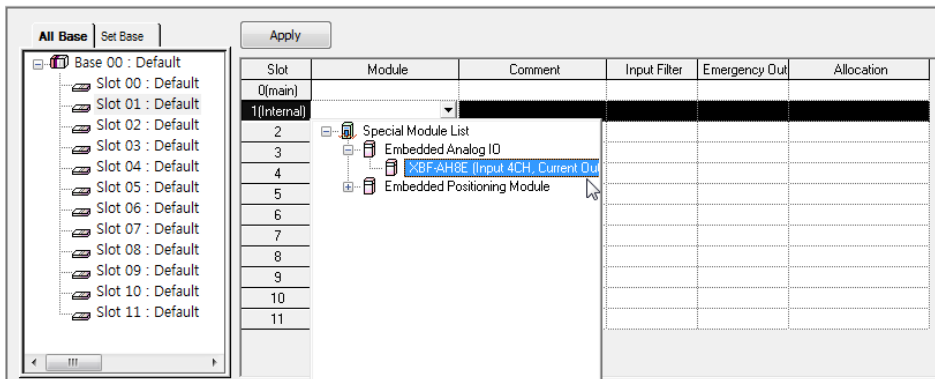

(5) In order to set up parameter, double-click the module.

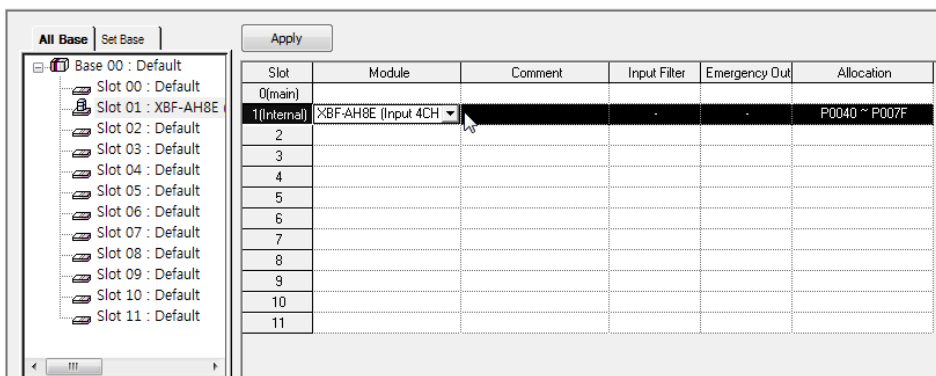

(6) A screen will be displayed for you to specify parameters for respective channels as below. Click a desired item to display parameters to set for respective items.

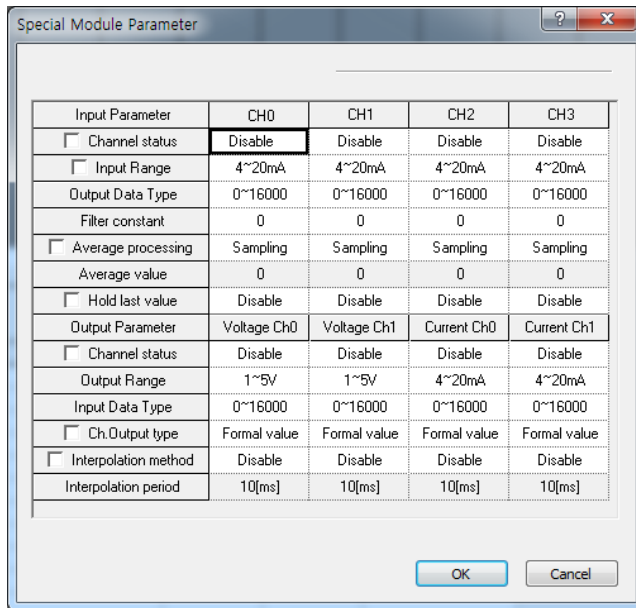

1.8 Special Module Monitoring Functions

Functions of Special Module Monitoring are as described below.

1) Start of [Special Module Monitoring]

Go through [Online] → [Connect] and [Monitor] → [Special module Monitoring] to start. If the status is not online, [Special Module Monitoring] menu will not be activated.

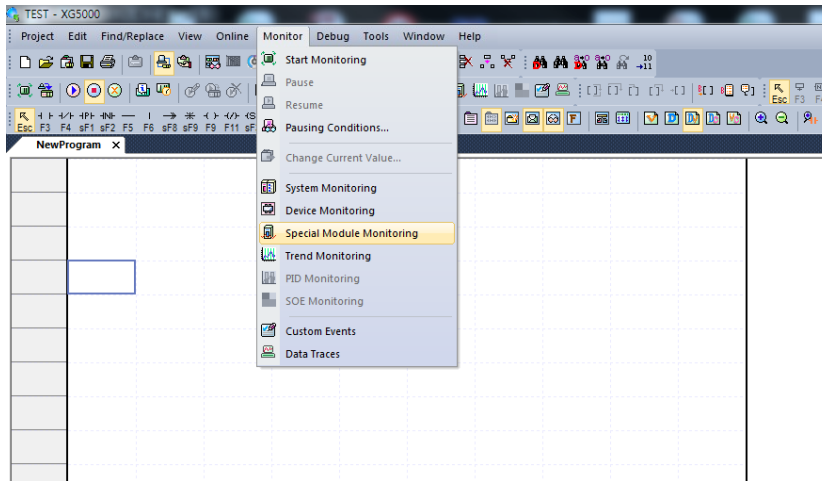

Notes

- 1) The screen may not normally be shown due to the lack of system resource. In this case, terminate all applications and try to start XG5000 again.
- 2) I/O parameter set in status of [Special Module Monitor] is temporarily set to implement the test. So, If status of [Special Module Monitor] is ended, I/O parameter which is set becomes extinct.
- 3) The test of [Special Module Monitor] is an examination function to check operation of the analog input module when the sequence program is not made up.

2) How to use special module monitoring

- (1) With XG5000 connected to PLC CPU (on-line status), click [Monitor] → [Special Module Monitoring] to display 'Special Module Select' screen as below showing base/slot information in addition to special module type. The module installed on the present PLC system will be displayed on the list dialog box.

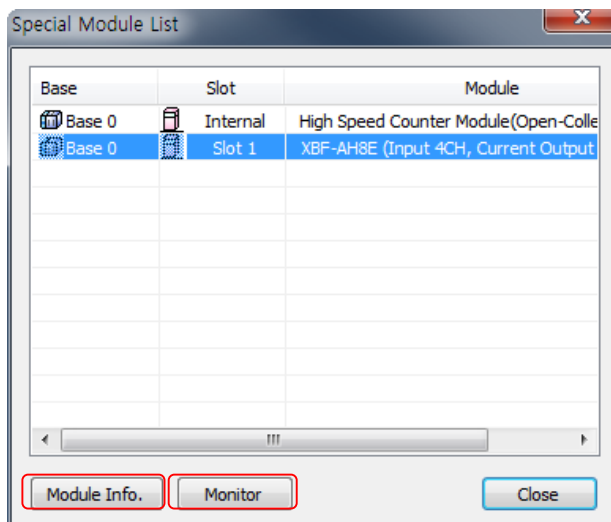

(2) Select “Special Module” and click [Module information] to display the information as below.

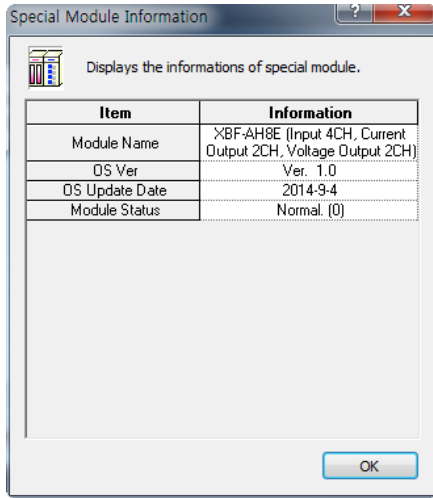

(3) Click [Monitor] on the “Special Module” screen in [Special Module List] to display [Special Module Monitoring] screen as below.

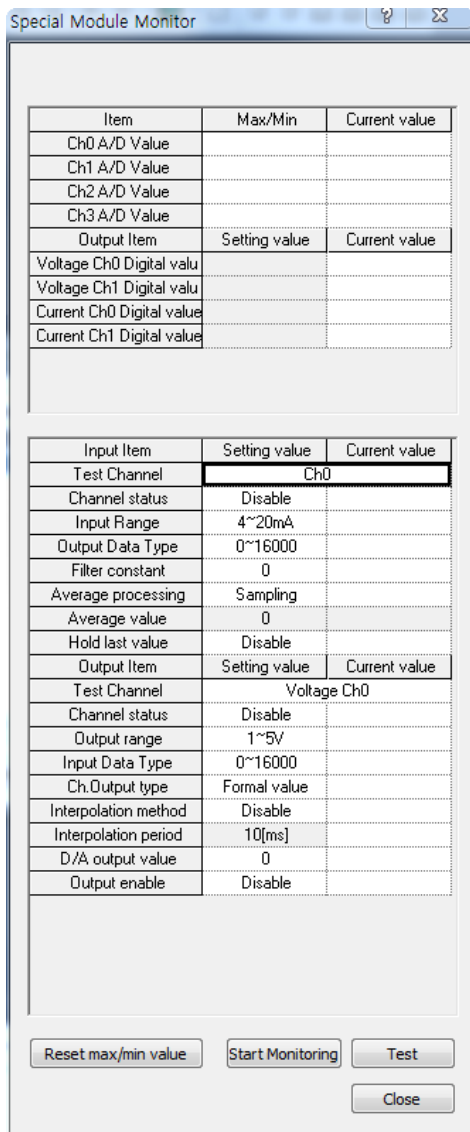

(4) Start Monitoring: Click [Start Monitoring] to show digital input / output data of current operated channel.

The screenshot shows the 'Special Module Monitor' window with the following data:

Item	Max/Min	Current value
Ch0 A/D Value	-192 / -192	-192
Ch1 A/D Value	952 / 952	952
Ch2 A/D Value	2 / 1	1
Ch3 A/D Value	0 / -1	-1
Output Item	Setting value	Current value
Voltage Ch0 Digital valu		0
Voltage Ch1 Digital valu		0
Current Ch0 Digital value		0
Current Ch1 Digital value		0

Input Item	Setting value	Current value
Test Channel	Ch0	
Channel status	Disable	Enable
Input Range	4~20mA	4~20mA
Output Data Type	0~16000	0~16000
Filter constant	0	0
Average processing	Sampling	Sampling
Average value	0	0
Hold last value	Disable	Disable
Output Item	Setting value	Current value
Test Channel	Voltage Ch0	
Channel status	Disable	Enable
Output range	1~5V	1~5V
Input Data Type	0~16000	0~16000
Ch.Output type	Formal value	Formal value
Interpolation method	Disable	Disable
Interpolation period	10[ms]	10[ms]
D/A output value	0	0
Output enable	Disable	Disable

Buttons at the bottom: Reset max/min value, Stop Monitoring, Test, Close.

Annotations with arrows:

- Monitoring (points to the top table)
- Input channel 0 details (points to the middle table)
- Voltage output channel 0 details (points to the bottom table)

Execution screen of [Start Monitoring]

- (5) Test: [Test] is a function to change the parameter of the embedded analog module which is presently set. In case of clicking the setting value in the bottom of the screen, you can change the parameter. [Test] is able to set only if operation status of XGB's basic unit is stop.

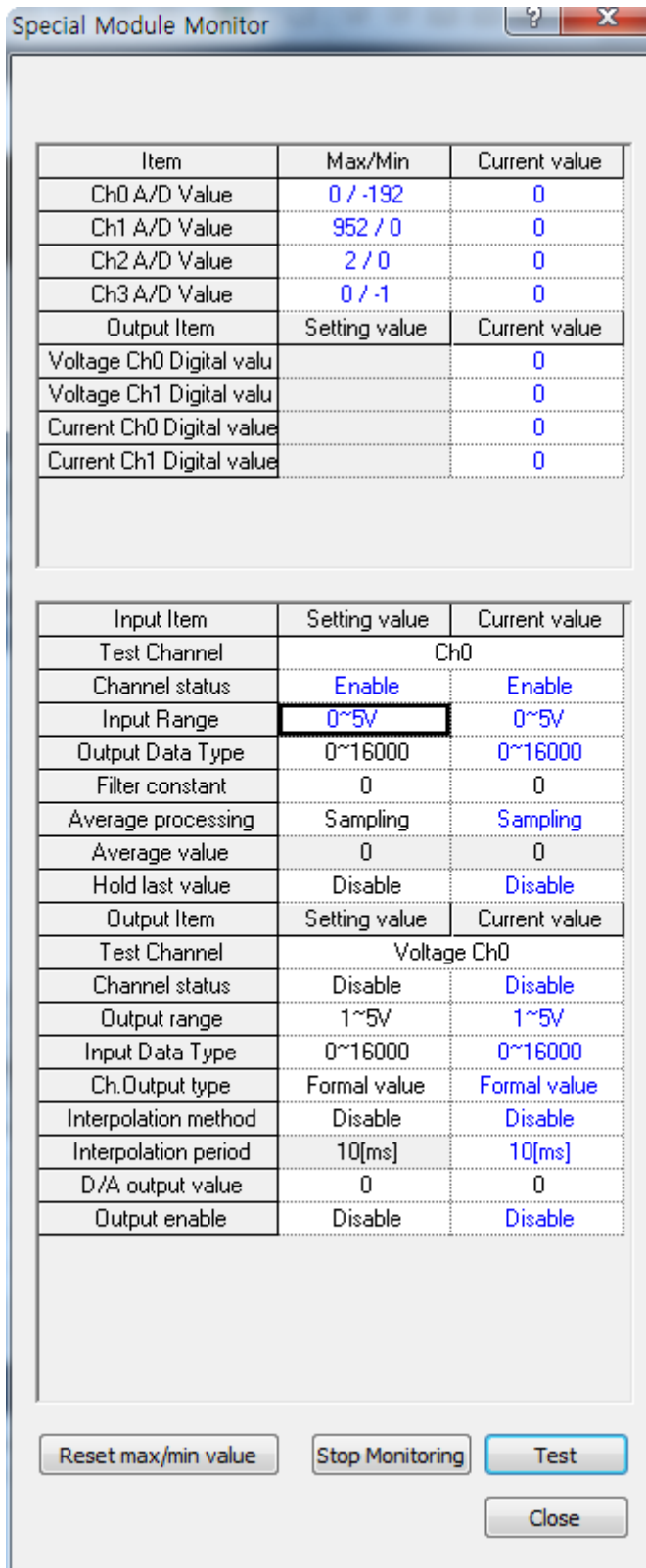

Execution screen of [Test]

(6) Max/Min Value Monitor

Max/Min value of input channel in operation can be monitored. However, visible Max/Min values are based on present value.

So Max/Min value is not saved when [Monitoring/Test Screen] is closed.

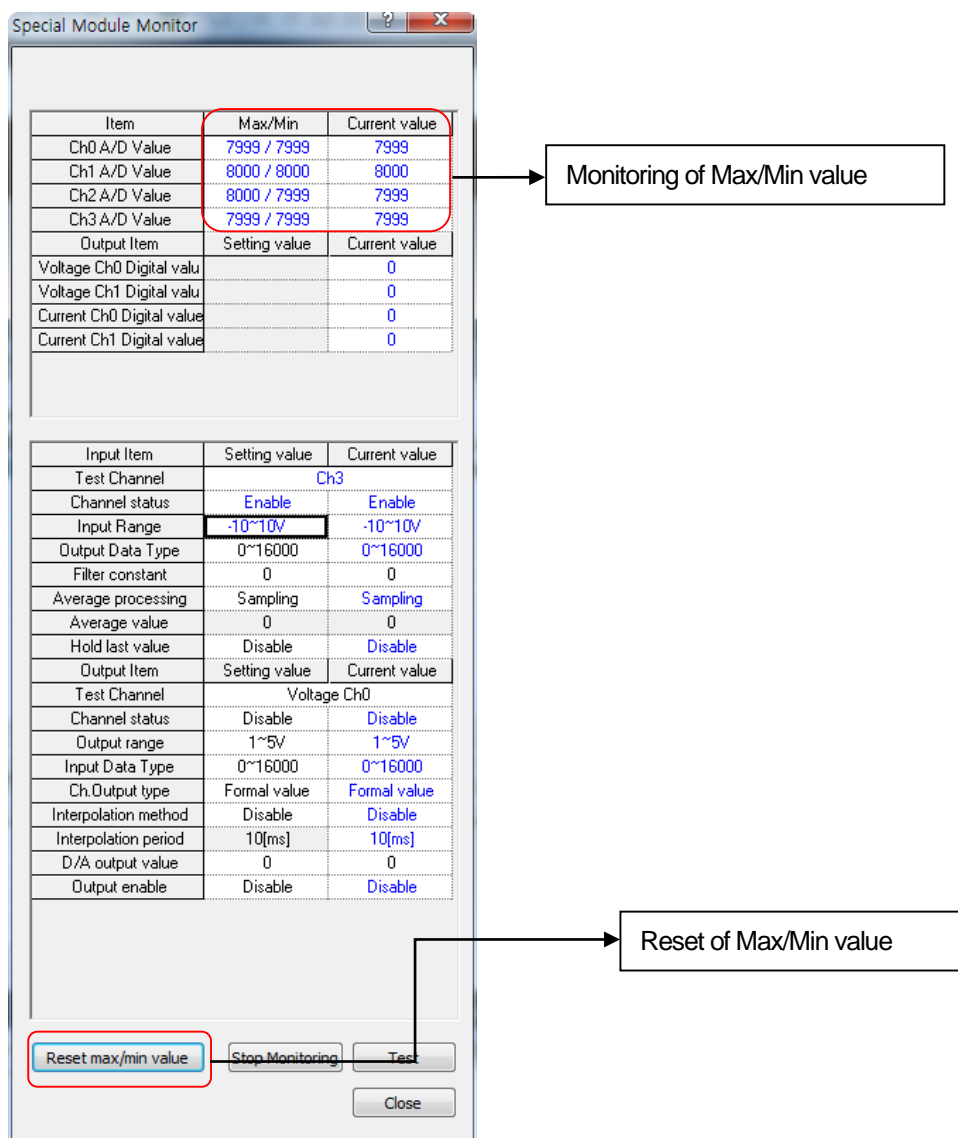

[Max/Min Value Monitor] execution screen

(7) Close

[Close]: [Close] is used to escape from the monitoring/test screen. When the monitoring /test screen is closed, the max. value, the min. value and the present value will not be saved any more.

1.9 Register U Devices

Register the variables for each module referring to the special module information that is set in the I/O parameter. The user can modify the variables and comments.

1) Procedure

(1) Select the special module type in the slot 1(internal) of [I/O Parameter Setting] window.

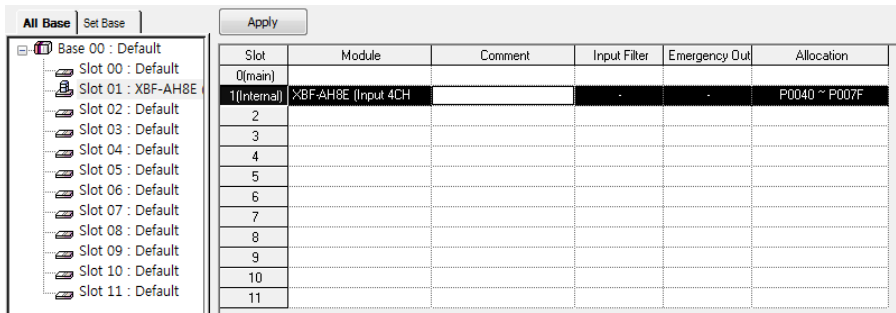

(2) Select [Edit] – [Register Module Variable Comments].

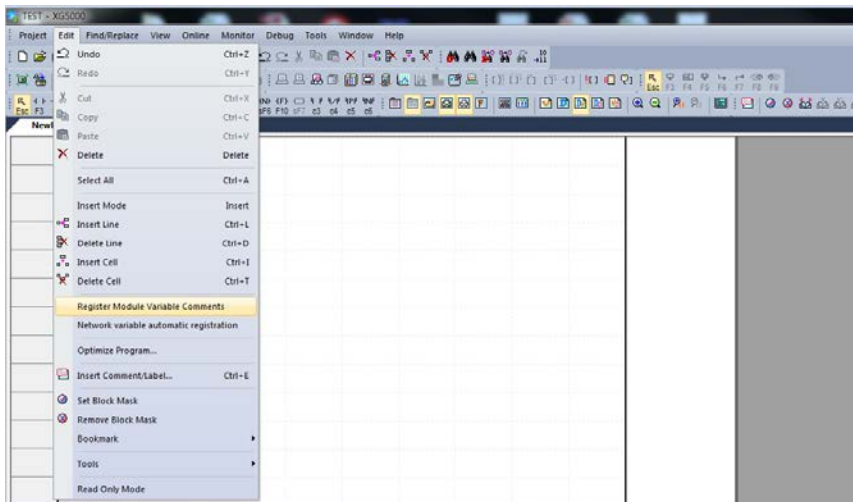

(3) Click 'Yes'.

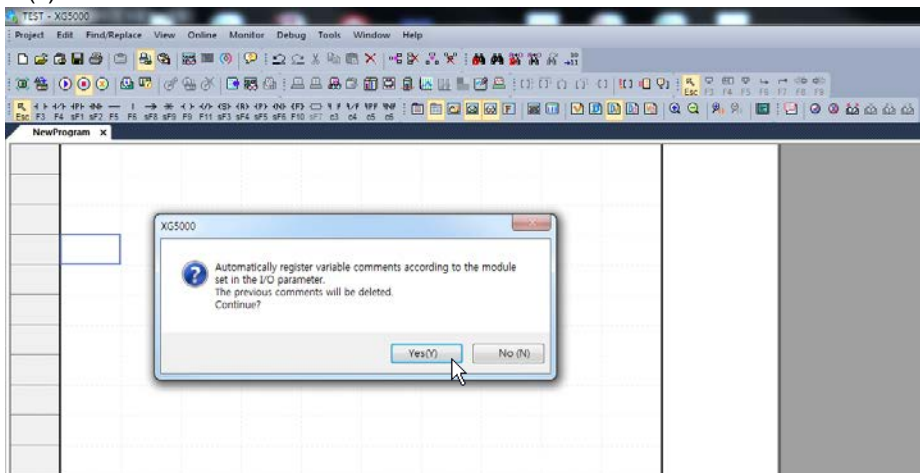

(4) As shown below, the variables are registered.

	Variable Kind	Variable	Type	Address	Initia	Retain	Used	EIP	Comment
1	VAR_GLOBAL	_01_AD0_ACT	BOOL	%UX0.1.16		<input type="checkbox"/>	<input type="checkbox"/>	<input type="checkbox"/>	Embedded Analog Input : CH0 Active
2	VAR_GLOBAL	_01_AD0_DATA	WORD	%UW0.1.3		<input type="checkbox"/>	<input type="checkbox"/>	<input type="checkbox"/>	Embedded Analog Input : CH0 Output
3	VAR_GLOBAL	_01_AD0_ERR	BOOL	%UX0.1.32		<input type="checkbox"/>	<input type="checkbox"/>	<input type="checkbox"/>	Embedded Analog Input : CH0 Error
4	VAR_GLOBAL	_01_AD0_HOOR	BOOL	%UX0.1.128		<input type="checkbox"/>	<input type="checkbox"/>	<input type="checkbox"/>	Embedded Analog Input : CH0 Alarm (Upper Limit)
5	VAR_GLOBAL	_01_AD0_IDD	BOOL	%UX0.1.112		<input type="checkbox"/>	<input type="checkbox"/>	<input type="checkbox"/>	Embedded Analog Input : CH0 Input Disconnection Fla
6	VAR_GLOBAL	_01_AD0_LOOR	BOOL	%UX0.1.144		<input type="checkbox"/>	<input type="checkbox"/>	<input type="checkbox"/>	Embedded Analog Input : CH0 Alarm (Lower Limit)
7	VAR_GLOBAL	_01_AD1_ACT	BOOL	%UX0.1.17		<input type="checkbox"/>	<input type="checkbox"/>	<input type="checkbox"/>	Embedded Analog Input : CH1 Active
8	VAR_GLOBAL	_01_AD1_DATA	WORD	%UW0.1.4		<input type="checkbox"/>	<input type="checkbox"/>	<input type="checkbox"/>	Embedded Analog Input : CH1 Output
9	VAR_GLOBAL	_01_AD1_ERR	BOOL	%UX0.1.33		<input type="checkbox"/>	<input type="checkbox"/>	<input type="checkbox"/>	Embedded Analog Input : CH1 Error
10	VAR_GLOBAL	_01_AD1_HOOR	BOOL	%UX0.1.129		<input type="checkbox"/>	<input type="checkbox"/>	<input type="checkbox"/>	Embedded Analog Input : CH1 Alarm (Upper Limit)
11	VAR_GLOBAL	_01_AD1_IDD	BOOL	%UX0.1.113		<input type="checkbox"/>	<input type="checkbox"/>	<input type="checkbox"/>	Embedded Analog Input : CH1 Input Disconnection Fla
12	VAR_GLOBAL	_01_AD1_LOOR	BOOL	%UX0.1.145		<input type="checkbox"/>	<input type="checkbox"/>	<input type="checkbox"/>	Embedded Analog Input : CH1 Alarm (Lower Limit)
13	VAR_GLOBAL	_01_AD2_ACT	BOOL	%UX0.1.18		<input type="checkbox"/>	<input type="checkbox"/>	<input type="checkbox"/>	Embedded Analog Input : CH2 Active
14	VAR_GLOBAL	_01_AD2_DATA	WORD	%UW0.1.5		<input type="checkbox"/>	<input type="checkbox"/>	<input type="checkbox"/>	Embedded Analog Input : CH2 Output
15	VAR_GLOBAL	_01_AD2_ERR	BOOL	%UX0.1.34		<input type="checkbox"/>	<input type="checkbox"/>	<input type="checkbox"/>	Embedded Analog Input : CH2 Error
16	VAR_GLOBAL	_01_AD2_HOOR	BOOL	%UX0.1.130		<input type="checkbox"/>	<input type="checkbox"/>	<input type="checkbox"/>	Embedded Analog Input : CH2 Alarm (Upper Limit)
17	VAR_GLOBAL	_01_AD2_IDD	BOOL	%UX0.1.114		<input type="checkbox"/>	<input type="checkbox"/>	<input type="checkbox"/>	Embedded Analog Input : CH2 Input Disconnection Fla
18	VAR_GLOBAL	_01_AD2_LOOR	BOOL	%UX0.1.146		<input type="checkbox"/>	<input type="checkbox"/>	<input type="checkbox"/>	Embedded Analog Input : CH2 Alarm (Lower Limit)
19	VAR_GLOBAL	_01_AD3_ACT	BOOL	%UX0.1.19		<input type="checkbox"/>	<input type="checkbox"/>	<input type="checkbox"/>	Embedded Analog Input : CH3 Active
20	VAR_GLOBAL	_01_AD3_DATA	WORD	%UW0.1.6		<input type="checkbox"/>	<input type="checkbox"/>	<input type="checkbox"/>	Embedded Analog Input : CH3 Output
21	VAR_GLOBAL	_01_AD3_ERR	BOOL	%UX0.1.35		<input type="checkbox"/>	<input type="checkbox"/>	<input type="checkbox"/>	Embedded Analog Input : CH3 Error
22	VAR_GLOBAL	_01_AD3_HOOR	BOOL	%UX0.1.131		<input type="checkbox"/>	<input type="checkbox"/>	<input type="checkbox"/>	Embedded Analog Input : CH3 Alarm (Upper Limit)
23	VAR_GLOBAL	_01_AD3_IDD	BOOL	%UX0.1.115		<input type="checkbox"/>	<input type="checkbox"/>	<input type="checkbox"/>	Embedded Analog Input : CH3 Input Disconnection Fla
24	VAR_GLOBAL	_01_AD3_LOOR	BOOL	%UX0.1.147		<input type="checkbox"/>	<input type="checkbox"/>	<input type="checkbox"/>	Embedded Analog Input : CH3 Alarm (Lower Limit)
25	VAR_GLOBAL	_01_DAI0_ACT	BOOL	%UX0.1.26		<input type="checkbox"/>	<input type="checkbox"/>	<input type="checkbox"/>	Embedded Analog Output : Current CH0 Active
26	VAR_GLOBAL	_01_DAI0_DATA	WORD	%UW0.1.13		<input type="checkbox"/>	<input type="checkbox"/>	<input type="checkbox"/>	Embedded Analog Output : Current CH0 Input
27	VAR_GLOBAL	_01_DAI0_ERR	BOOL	%UX0.1.42		<input type="checkbox"/>	<input type="checkbox"/>	<input type="checkbox"/>	Embedded Analog Output : Current CH0 Error
28	VAR_GLOBAL	_01_DAI0_INTP	BOOL	%UX0.1.122		<input type="checkbox"/>	<input type="checkbox"/>	<input type="checkbox"/>	Embedded Analog Output : Current CH0 Interpolation E
29	VAR_GLOBAL	_01_DAI0_ODD	BOOL	%UX0.1.126		<input type="checkbox"/>	<input type="checkbox"/>	<input type="checkbox"/>	Embedded Analog Output : Current CH0 Output Discon
30	VAR_GLOBAL	_01_DAI0_OUTEN	BOOL	%UX0.1.162		<input type="checkbox"/>	<input type="checkbox"/>	<input type="checkbox"/>	Embedded Analog Output : Current CH0 Output Status
31	VAR_GLOBAL	_01_DAI1_ACT	BOOL	%UX0.1.27		<input type="checkbox"/>	<input type="checkbox"/>	<input type="checkbox"/>	Embedded Analog Output : Current CH1 Active
32	VAR_GLOBAL	_01_DAI1_DATA	WORD	%UW0.1.14		<input type="checkbox"/>	<input type="checkbox"/>	<input type="checkbox"/>	Embedded Analog Output : Current CH1 Input
33	VAR_GLOBAL	_01_DAI1_ERR	BOOL	%UX0.1.43		<input type="checkbox"/>	<input type="checkbox"/>	<input type="checkbox"/>	Embedded Analog Output : Current CH1 Error
34	VAR_GLOBAL	_01_DAI1_INTP	BOOL	%UX0.1.123		<input type="checkbox"/>	<input type="checkbox"/>	<input type="checkbox"/>	Embedded Analog Output : Current CH1 Interpolation E
35	VAR_GLOBAL	_01_DAI1_ODD	BOOL	%UX0.1.127		<input type="checkbox"/>	<input type="checkbox"/>	<input type="checkbox"/>	Embedded Analog Output : Current CH1 Output Discon
36	VAR_GLOBAL	_01_DAI1_OUTEN	BOOL	%UX0.1.163		<input type="checkbox"/>	<input type="checkbox"/>	<input type="checkbox"/>	Embedded Analog Output : Current CH1 Output Status
37	VAR_GLOBAL	_01_DAV0_ACT	BOOL	%UX0.1.24		<input type="checkbox"/>	<input type="checkbox"/>	<input type="checkbox"/>	Embedded Analog Output : Voltage CH0 Active
38	VAR_GLOBAL	_01_DAV0_DATA	WORD	%UW0.1.11		<input type="checkbox"/>	<input type="checkbox"/>	<input type="checkbox"/>	Embedded Analog Output : Voltage CH0 Input
39	VAR_GLOBAL	_01_DAV0_ERR	BOOL	%UX0.1.40		<input type="checkbox"/>	<input type="checkbox"/>	<input type="checkbox"/>	Embedded Analog Output : Voltage CH0 Error
40	VAR_GLOBAL	_01_DAV0_INTP	BOOL	%UX0.1.120		<input type="checkbox"/>	<input type="checkbox"/>	<input type="checkbox"/>	Embedded Analog Output : Voltage CH0 Interpolation E
41	VAR_GLOBAL	_01_DAV0_OUTEN	BOOL	%UX0.1.160		<input type="checkbox"/>	<input type="checkbox"/>	<input type="checkbox"/>	Embedded Analog Output : Voltage CH0 Output Status
42	VAR_GLOBAL	_01_DAV1_ACT	BOOL	%UX0.1.25		<input type="checkbox"/>	<input type="checkbox"/>	<input type="checkbox"/>	Embedded Analog Output : Voltage CH1 Active
43	VAR_GLOBAL	_01_DAV1_DATA	WORD	%UW0.1.12		<input type="checkbox"/>	<input type="checkbox"/>	<input type="checkbox"/>	Embedded Analog Output : Voltage CH1 Input
44	VAR_GLOBAL	_01_DAV1_ERR	BOOL	%UX0.1.41		<input type="checkbox"/>	<input type="checkbox"/>	<input type="checkbox"/>	Embedded Analog Output : Voltage CH1 Error
45	VAR_GLOBAL	_01_DAV1_INTP	BOOL	%UX0.1.121		<input type="checkbox"/>	<input type="checkbox"/>	<input type="checkbox"/>	Embedded Analog Output : Voltage CH1 Interpolation E

2) Save variables

- (1) The contents of 'View Variable' can be saved as a text file.
- (2) Select [Edit] -> [Export to File].
- (3) The contents of 'View variable' are saved as a text file.

3) View variables in program

The example of XGB-DN32UA is as shown below.

(1) The example program of XG5000 is as shown below.

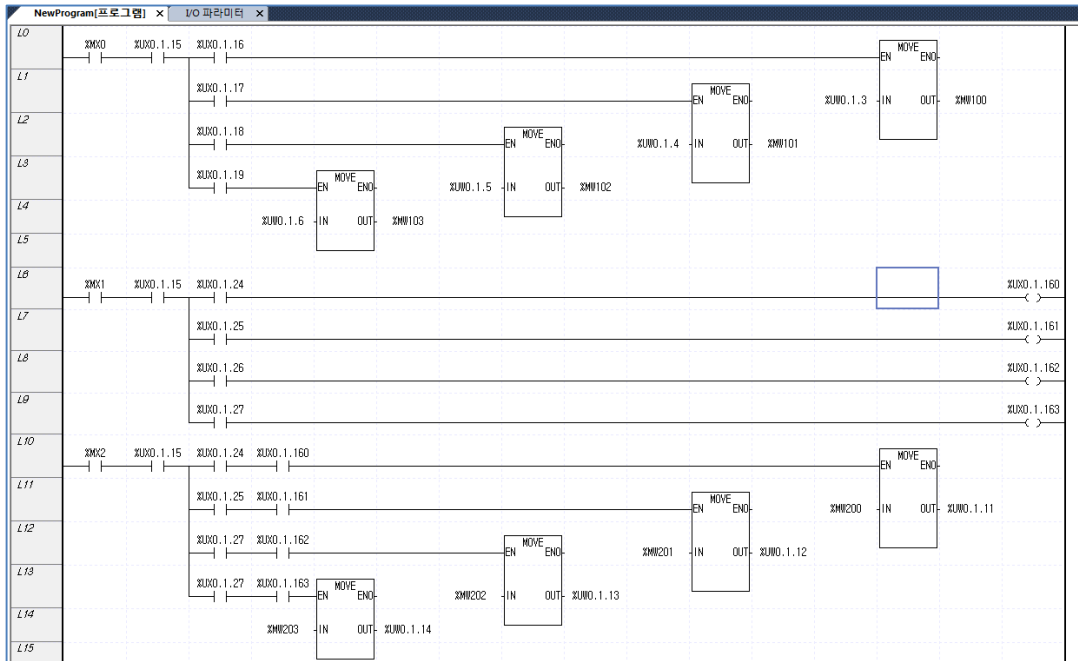

(2) Select [View] -> [Variables]. The devices are changed into variables.

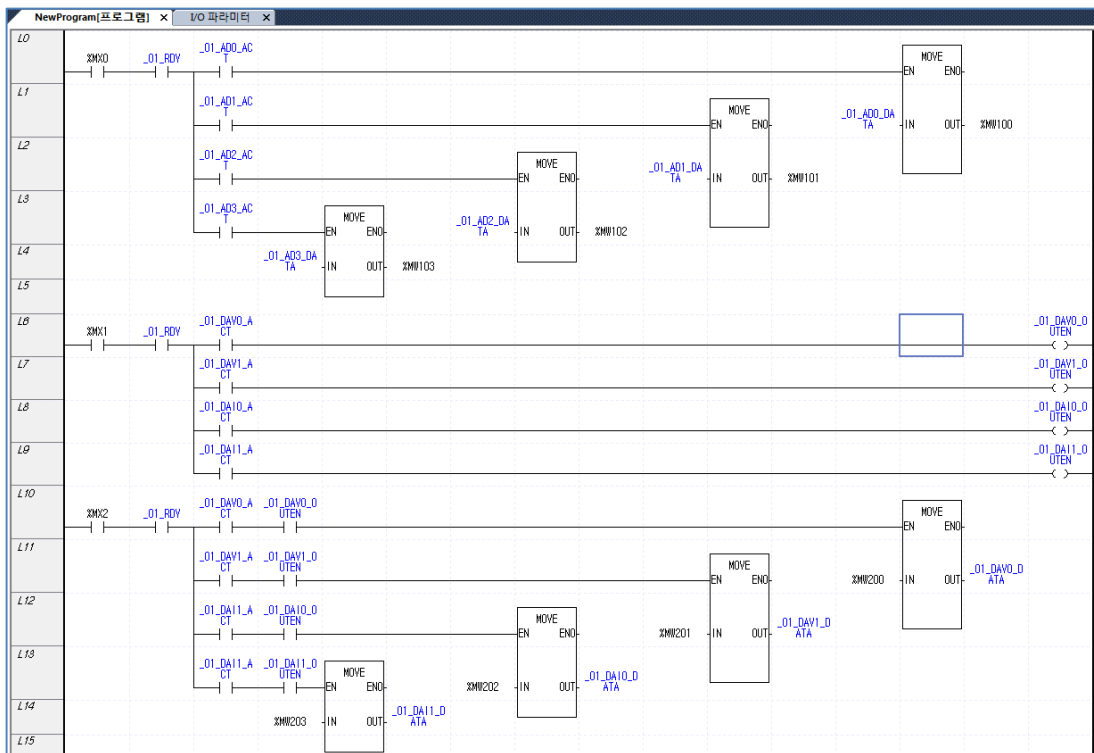

(3) Select [View] -> [Devices/Variables]. Devices and variables are both displayed.

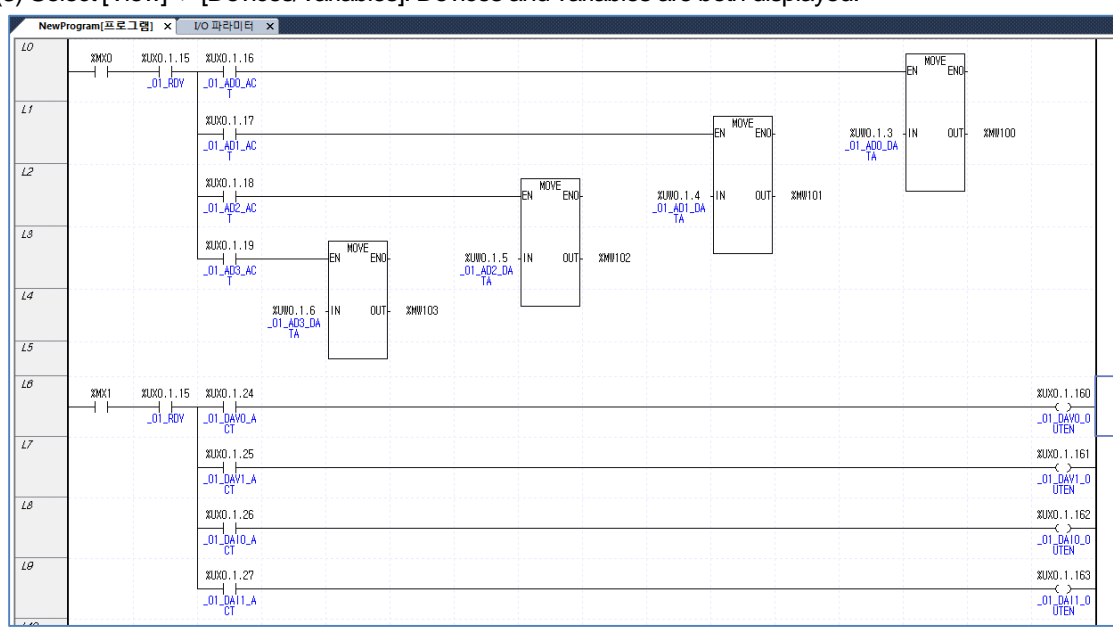

(4) Select [View] -> [Device/Comments]. Devices and comments are both displayed.

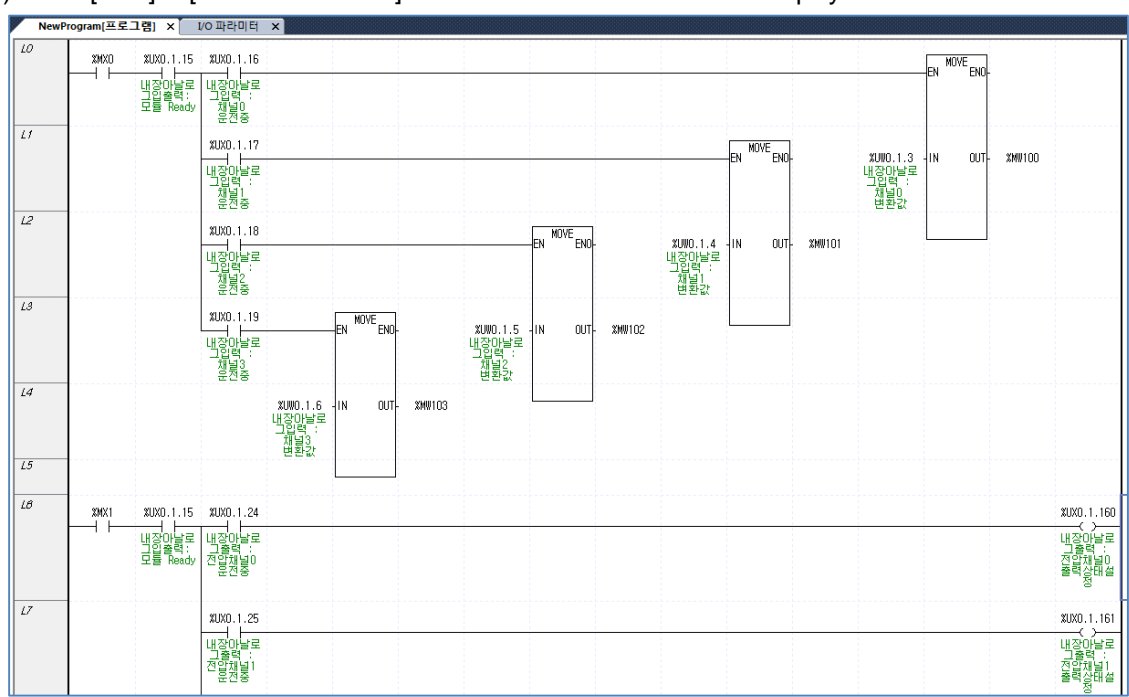

(5) Select [View] -> [Variables/Comments]. Variables and comments are both displayed.

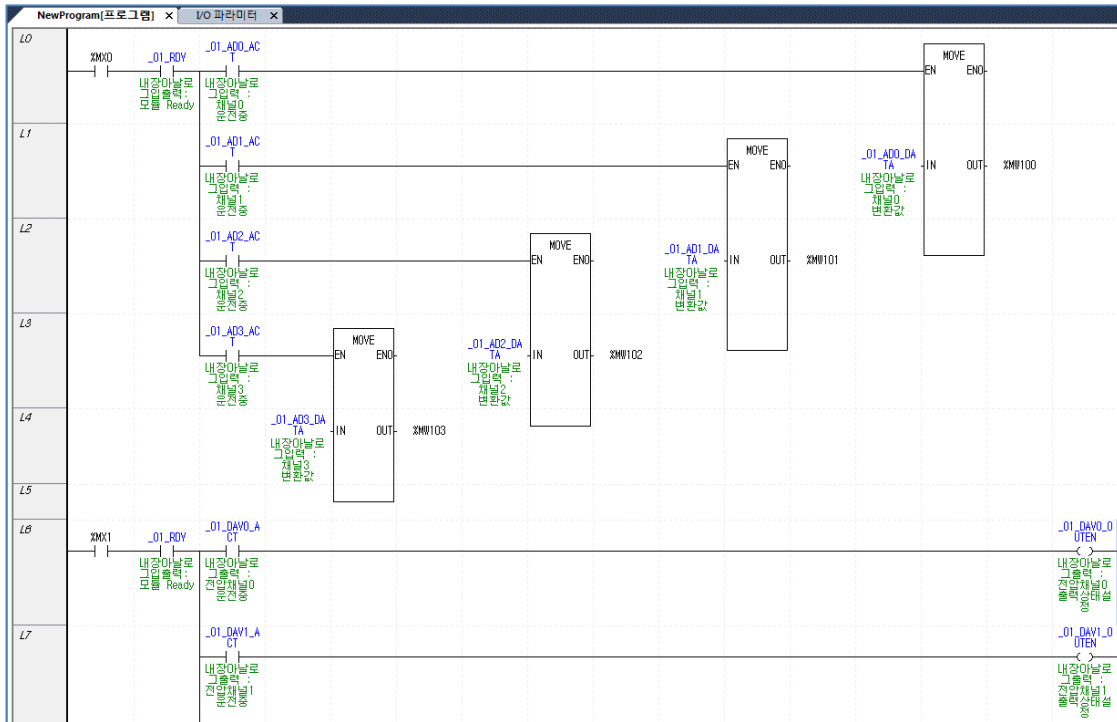

1.10 Configuration and Function of Internal Memory

1.10.1 I/O Area of Embedded Analog Data

I/O area of embedded analog data is as displayed in table

Variable name	Type	Device assigned	Comment	Read/Write	Direction of signal
_01_ERR	BIT	%UX0.1.0	Analog IO : Module Error	Read	AH8E → CPU
_01_RDY	BIT	%UX0.1.15	Analog IO : Module Ready		
_01_AD0_ACT	BIT	%UX0.1.16	Analog Input : CH0 Active	Read	AH8E → CPU
_01_AD1_ACT	BIT	%UX0.1.17	Analog Input : CH1 Active		
_01_AD2_ACT	BIT	%UX0.1.18	Analog Input : CH2 Active		
_01_AD3_ACT	BIT	%UX0.1.19	Analog Input : CH3 Active		
_01_DAV0_ACT	BIT	%UX0.1.24	Analog Output : Voltage CH0 Active		
_01_DAV1_ACT	BIT	%UX0.1.25	Analog Output : Voltage CH1 Active		
_01_DAI0_ACT	BIT	%UX0.1.26	Analog Output : Current CH0 Active		
_01_DAI1_ACT	BIT	%UX0.1.27	Analog Output : Current CH1 Active		
_01_AD0_ERR	BIT	%UX0.1.32	Analog Input : CH0 Error	Read	AH8E → CPU
_01_AD1_ERR	BIT	%UX0.1.33	Analog Input : CH1 Error		
_01_AD2_ERR	BIT	%UX0.1.34	Analog Input : CH2 Error		
_01_AD3_ERR	BIT	%UX0.1.35	Analog Input : CH3 Error		
_01_DAV0_ERR	BIT	%UX0.1.40	Analog Output : Voltage CH0 Error		
_01_DAV1_ERR	BIT	%UX0.1.41	Analog Output : Voltage CH1 Error		
_01_DAI0_ERR	BIT	%UX0.1.42	Analog Output : Current CH0 Error		
_01_DAI1_ERR	BIT	%UX0.1.43	Analog Output : Current CH1 Error		
_01_AD0_DATA	WORD	%UW0.1.3	Analog Input : CH0 Output	Read	AH8E → CPU
_01_AD1_DATA	WORD	%UW0.1.4	Analog Input : CH1 Output		
_01_AD2_DATA	WORD	%UW0.1.5	Analog Input : CH2 Output		
_01_AD3_DATA	WORD	%UW0.1.6	Analog Input : CH3 Output		
_01_AD0_IDD	BIT	%UX0.1.112	Analog Input : CH0 Input Disconnection Flag	Read	AH8E → CPU
_01_AD1_IDD	BIT	%UX0.1.113	Analog Input : CH1 Input Disconnection Flag		
_01_AD2_IDD	BIT	%UX0.1.114	Analog Input : CH2 Input Disconnection Flag		
_01_AD3_IDD	BIT	%UX0.1.115	Analog Input : CH3 Input Disconnection Flag		
_01_DAV0_INTP	BIT	%UX0.1.120	Analog Output : Voltage CH0 Interpolation Enabled	Read	AH8E → CPU
_01_DAV1_INTP	BIT	%UX0.1.121	Analog Output : Voltage CH1 Interpolation Enabled		
_01_DAI0_INTP	BIT	%UX0.1.122	Analog Output : Current CH0 Interpolation Enabled		
_01_DAI1_INTP	BIT	%UX0.1.123	Analog Output : Current CH1 Interpolation Enabled		
_01_DAI0_IDD	BIT	%UX0.1.126	Analog Output : Current CH0 Output Disconnection		
_01_DAI1_IDD	BIT	%UX0.1.127	Analog Output : Current CH1 Output Disconnection		
_01_AD0_HOOR	BIT	%UX0.1.128	Analog Input : CH0 Alarm (Upper Limit)	Read	AH8E → CPU
_01_AD1_HOOR	BIT	%UX0.1.129	Analog Input : CH1 Alarm (Upper Limit)		
_01_AD2_HOOR	BIT	%UX0.1.130	Analog Input : CH2 Alarm (Upper Limit)		
_01_AD3_HOOR	BIT	%UX0.1.131	Analog Input : CH3 Alarm (Upper Limit)		
_01_AD0_LOOR	BIT	%UX0.1.144	Analog Input : CH0 Alarm (Lower Limit)	Read	AH8E → CPU
_01_AD1_LOOR	BIT	%UX0.1.145	Analog Input : CH1 Alarm (Lower Limit)		
_01_AD2_LOOR	BIT	%UX0.1.146	Analog Input : CH2 Alarm (Lower Limit)		
_01_AD3_LOOR	BIT	%UX0.1.147	Analog Input : CH3 Alarm (Lower Limit)		

Variable name	Type	Device assigned	Comment	Read/Write	Direction of signal
_01_DA_OUTEN	WORD	%UW0.1.10	Analog Output : Output Status Setting	Write	AH8E← CPU
_01_DAV0_OUTEN	BIT	%UX0.1.160	Analog Output : Voltage CH0 Output Status Setting	Write	AH8E← CPU
_01_DAV1_OUTEN	BIT	%UX0.1.161	Analog Output : Voltage CH1 Output Status Setting	Write	AH8E← CPU
_01_DAI0_OUTEN	BIT	%UX0.1.162	Analog Output : Current CH0 Output Status Setting	Write	AH8E← CPU
_01_DAI1_OUTEN	BIT	%UX0.1.163	Analog Output : Current CH1 Output Status Setting	Write	AH8E← CPU
_01_DAV0_DATA	WORD	%UW0.1.11	Analog Output : Voltage CH0 Input	Write	AH8E← CPU
_01_DAV1_DATA	WORD	%UW0.1.12	Analog Output : Voltage CH1 Input	Write	AH8E← CPU
_01_DAI0_DATA	WORD	%UW0.1.13	Analog Output : Current CH0 Input	Write	AH8E← CPU
_01_DAI1_DATA	WORD	%UW0.1.14	Analog Output : Current CH1 Input	Write	AH8E← CPU

- In order to read 'input CH3 conversion value' of embedded analog module, it shall be displayed as U01.06.

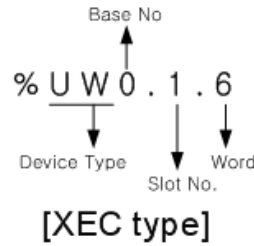
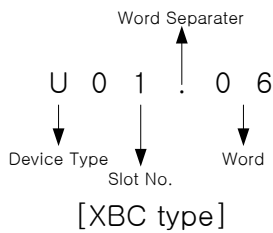

- In order to read 'voltage output CH1 conversion value' of embedded analog module, it shall be displayed as U01.12

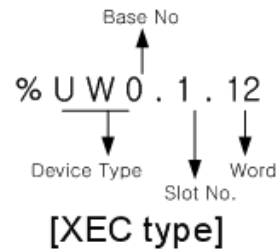
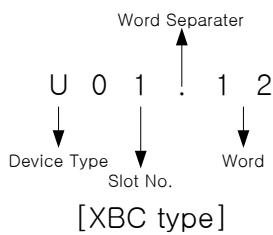

- In order to read 'current output CH0 output status setting' of embedded analog module, it shall be displayed as U01.10.2

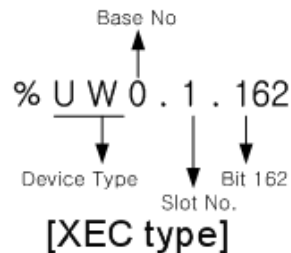
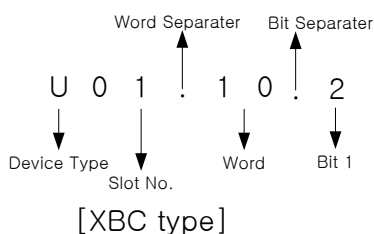

1) Embedded analog module Ready/Error flag

- (1) %UX1.1.15 : It will be ON when it is ready to process analog conversion in case of that PLC CPU is powered or reset.
- (2) %UX1.1.0 : It is a flag to display the error status of embedded analog module.

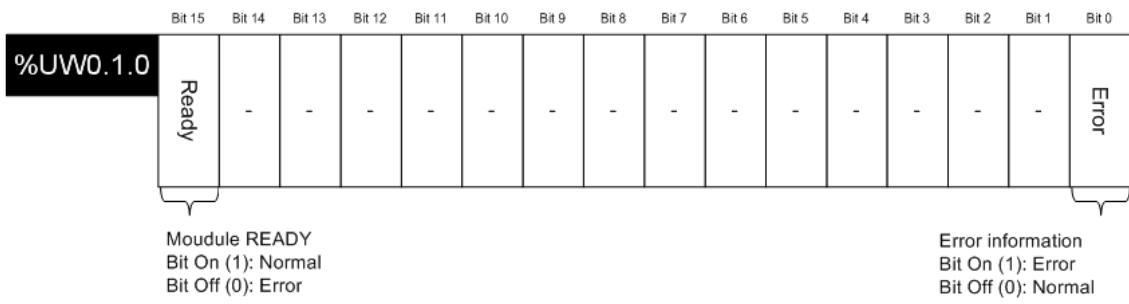

2) Run channel flag

The area where RUN information of respective channels is saved.

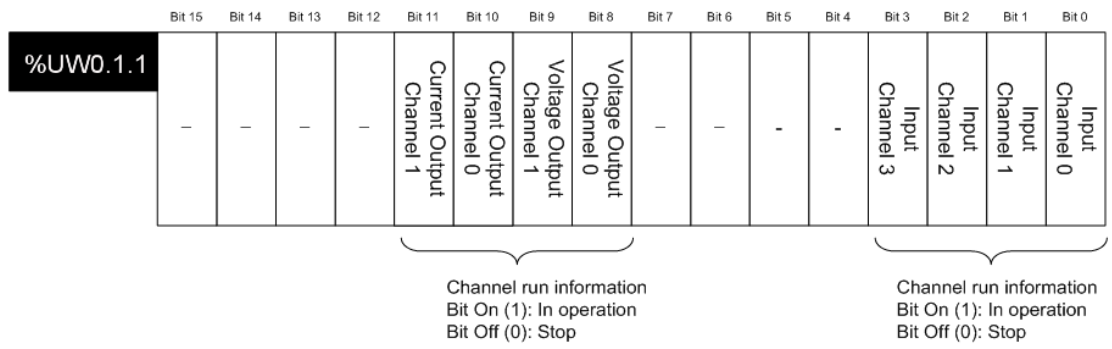

3) Error channel flag

The area where ERROR information of respective channels is saved.

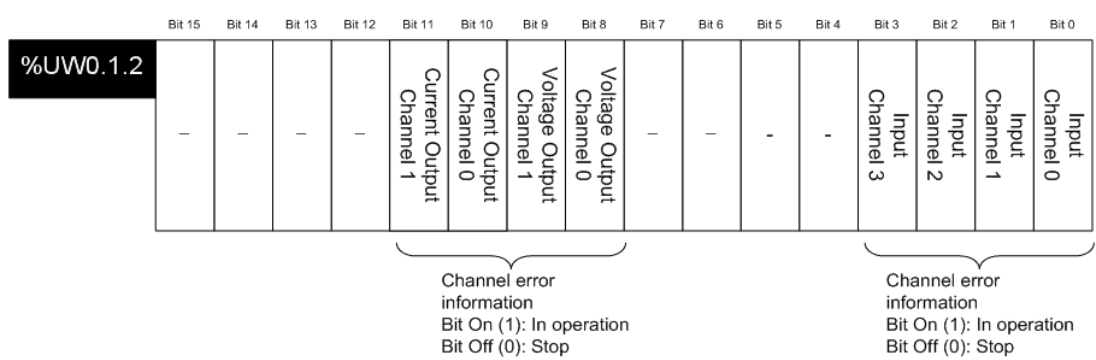

4) Digital output value of A/D conversion

(1) A/D converted-digital output value will be output to buffer memory addresses %UW0.1.3 to %UW0.1.6 for respective channels.

(2) Digital output value will be saved in 16-bit binary.

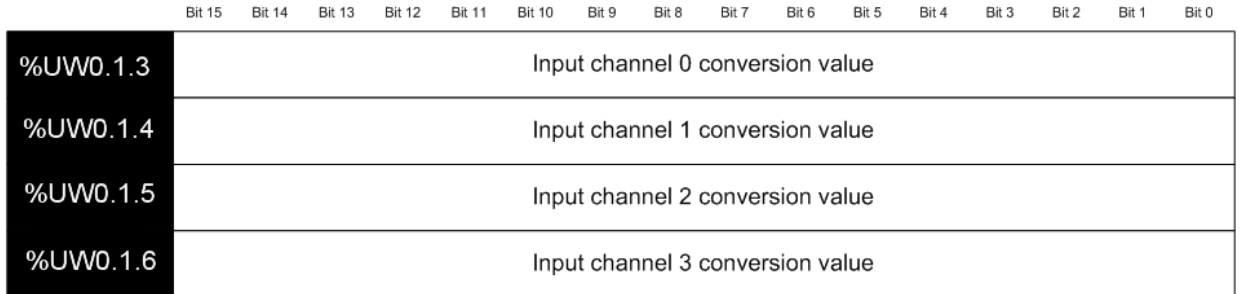

5) Disconnection flag

The area where the disconnection detection signal of each channel is saved.

(1) Disconnection flag of input channel is saved in %UX0.1.112 ~ %UX0.1.115 .

(2) Disconnection flag of output channel is saved in %UX0.1.126 ~ %UX0.1.127. (Only for current output channel)

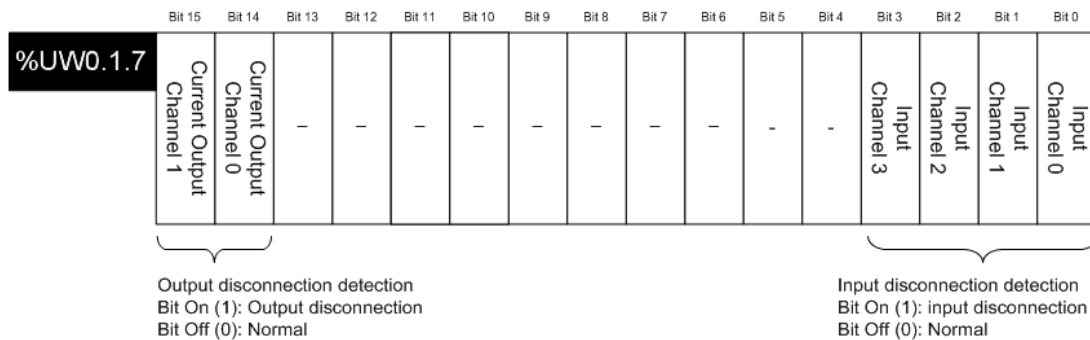

6) Status of interpolation output

The area shows the channel being outputting interpolation.

During interpolation output, the flag is saved in (U01.07.8 to U01.07.B).

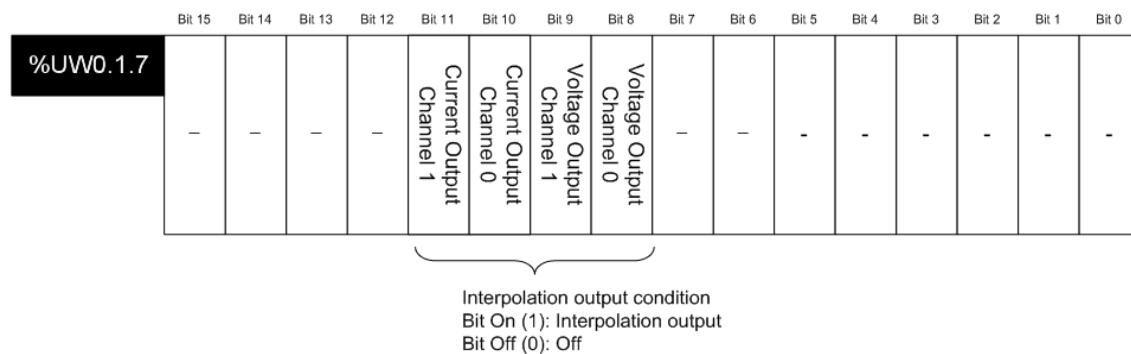

7) Upper limit alarm flag

The area where the upper limit alarm detection signal of each channel is saved. (%UX0.1.128 ~ %UX0.1.131)

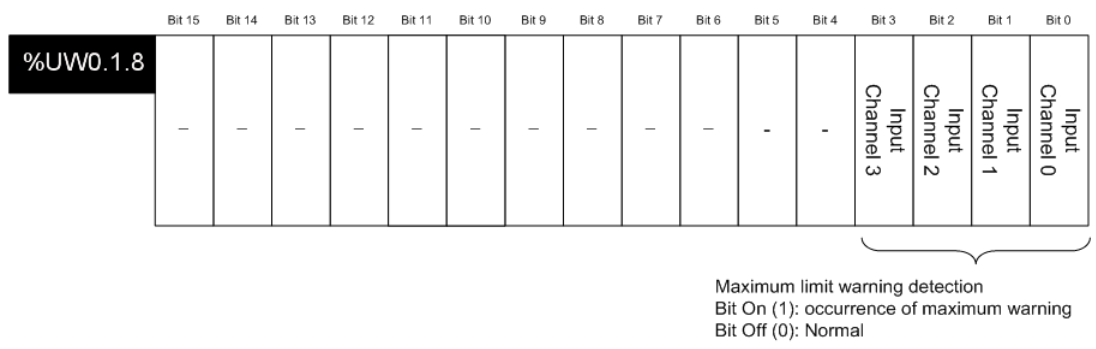

8) Lower limit alarm flag

The area where the lower limit alarm detection signal of each channel is saved. (%UX0.1.144 ~ %UX0.1.147)

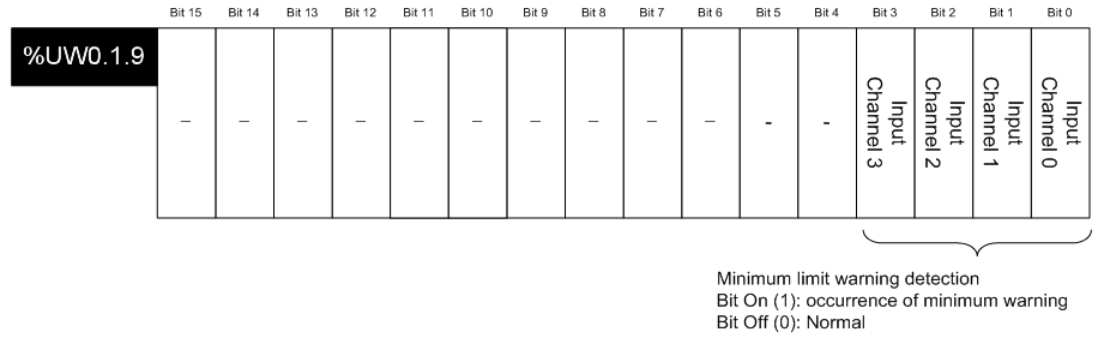

9) Output permission setting

- (1) The output enable / disable for each channel can be set.
- (2) When the output permission is not set, the output of all channels will be prohibited.

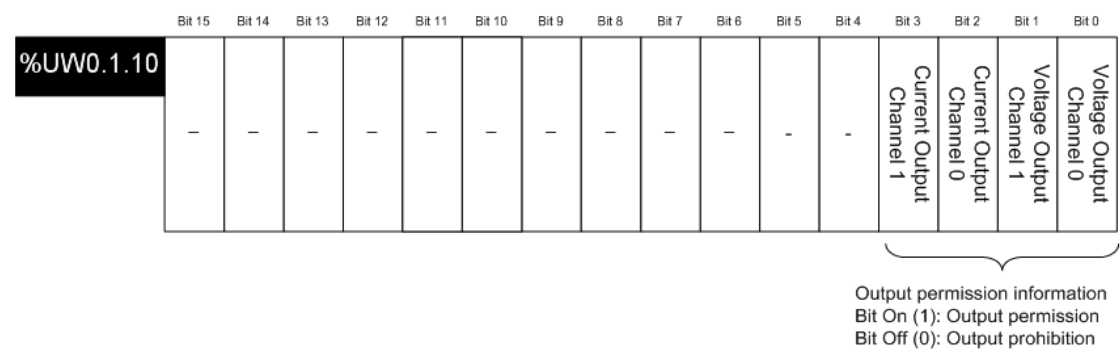

10) Digital input value of D/A conversion

(1) Unsigned value(-192~16,191 / 0~16,191), Signed value(-8,192~8,191 / -8,000~8,191), Precise value(-952~5,047 / -60~5,059 / -120~10,119 / -10,240~10,239 / 3,808~20,191 / 0~20,239), Percentile value(-120~10,119 / 0~10,119) can be used within these ranges depending on the setting of input data type.

(In case of Current output range is not 0~20mA / In case of Current output range is 0~20mA)

(2) If the digital input value is not set, it will be handled as '0'.

	Bit 15	Bit 14	Bit 13	Bit 12	Bit 11	Bit 10	Bit 9	Bit 8	Bit 7	Bit 6	Bit 5	Bit 4	Bit 3	Bit 2	Bit 1	Bit 0
%UW0.1.11	Digital input value for voltage output channel 0															
%UW0.1.12	Digital input value for voltage output channel 1															
%UW0.1.13	Digital input value for current output channel 0															
%UW0.1.14	Digital input value for current output channel 1															

Notes

(1) If the external 24V is not supplied, the module ready flag [%UX0.1.15], input disconnection flag [%UX0.1.112 ~%UX0.1.115] upper limit alarm flag[%UX0.1.128~%UX0.1.131], lower limit alarm flag [%UX0.1.144 ~%UX0.1.147]will be turned off.

1.10.2 Operation Parameters Setting Area

Setting area of embedded analog module's parameters is as described in table.

Memory address	Descriptions	Details	R/W	Remark
0	Specify channel to use	Bit Off (0): Stop Bit On (1): Run	R/W	PUT/GET
1	Voltage/current input range	Input range setting (4 Bits) 0000 : 4 ~ 20mA 0001 : 0 ~ 20mA 0010 : 1 ~ 5 V 0011 : 0 ~ 5 V 0100 : 0 ~ 10 V 0101 : -10 ~ 10V	R/W	
2	Voltage/current output range	Output range setting (4Bit) 0000 : 1 ~ 5 V or 4 ~ 20mA 0001 : 0 ~ 5 V or 0 ~ 20mA 0010 : 0 ~ 10 V 0011 : -10 ~ 10V	R/W	
3	Input/Output data type	Output data format setting (2 Bit) 00: 0 ~ 16,000 01: -8,000 ~ 8,000 10: Precise value 11: 0 ~ 10,000 - In case of precise value 4 ~ 20mA: 4,000 ~ 20,000 0 ~ 20mA: 0 ~ 20,000 1 ~ 5V: 1,000 ~ 5,000 0 ~ 5V: 0 ~ 5,000 0 ~ 10V: 0 ~ 10,000 -10 ~ 10V: -10,000 ~ 10,000	R/W	
4	Input CH0 filter constant	0 or 4 ~ 64,000	R/W	
5	Input CH1 filter constant			
6	Input CH2 filter constant			
7	Input CH3 filter constant			
8	Average processing method	Average process setting(4 Bit) 0000 : Sampling process 0001 : Time average process 0010 : Count average process 0011 : Moving average process 0100 : Weighted average process	R/W	
9	CH0 average value	Input channel average value setting Time average : 4 ~ 16,000 [ms] Count average : 2 ~ 64,000 [times] Moving average : 2 ~ 100 [samples] Weighted average : 1 ~ 99 [%]	R/W	
10	CH1 average value			
11	CH2 average value			
12	CH3 average value			
13	Hold last value	Bit 0 ~ Bit 3 0: Disable, 1: Enable	R/W	

Memory address	Descriptions	Details	R/W	Remark
14	Specify voltage output Ch0 setting	Output status setting (2Bit) 00: Previous value output 01: Min value output 10: Mid value output 11: Max value output	R/W	PUT/GET
15	Specify voltage output Ch1 setting			
16	Specify current output Ch0 setting			
17	Specify current output Ch1 setting			
18	Interpolation method	Interpolation method setting (2Bit) 00: Prohibition 01: Linear interpolation 10: S-type interpolation	R/W	PUT/GET
19	Interpolation time	Interpolation time setting (2Bit) 00: 10[ms] 01: 100[ms] 10: 1[s] 11: 60[s]	R/W	
20	Voltage output CH 0 interpolation value	When the interpolation operates: Show operated current output digital value. When the interpolation is prohibited: Show the output value in the data I/O area. (U01.11~14)	R	GET
21	Voltage output CH 1 interpolation value			
22	Current output CH 0 interpolation value			
23	Current output CH 1 interpolation value			
24	Setting error information	Setting error information (Decimal, #: Channel No.) *: output channel (voltage: 0, current: 1) 0: Normal operation 10#: Input channel range setting error 20#: Input channel filter constant setting error 30#: Input channel average constant setting error 4*#: Output channel range setting error 5*#: Output channel digital input value range over error 6*#: Output channel interpolation method setting error	R	GET

Notes

- (1) When memory addresses of area No. 1, 4~7, 9~12 are entered out of setting values, U01.02.0~U01.02.3 is ON and operates with basic setting value. Error information is shown on error information area(No. 24).
- (2) When memory addresses of area No. 2, 3, 18 are entered out of setting values, U01.02.8~U01.02.B is ON and operates with basic setting value. Error information is shown on error information area(No. 24).



Caution (3) The system area (after No. 25) is prohibited for reading/writing. If this area is changed, malfunction or breakdown can be made.

1) Operation channel setting

If the channel to use is not specified, all the channels will be set to Disable.

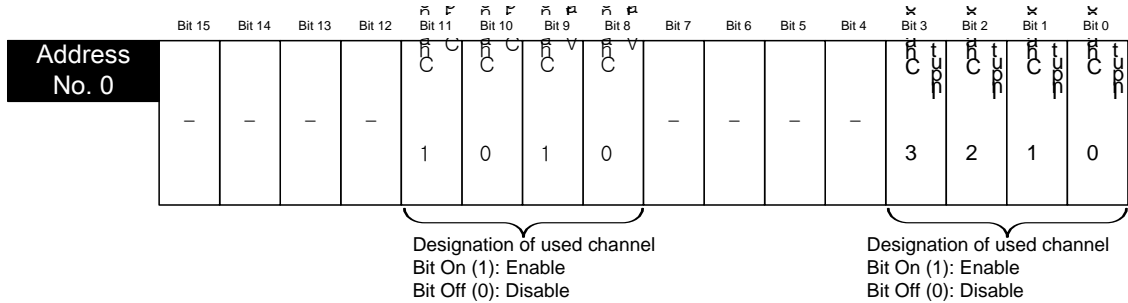

2) Input range setting

- (1) The ranges of analog input voltage are DC 1~5V, DC 0~5V, DC 0~10V, DC -10~10V, the ranges of analog current input are DC 4~20mA, DC 0~20mA.
- (2) When the input range is not set or it is entered out of setting values, it is handled as range of DC 4~20mA.

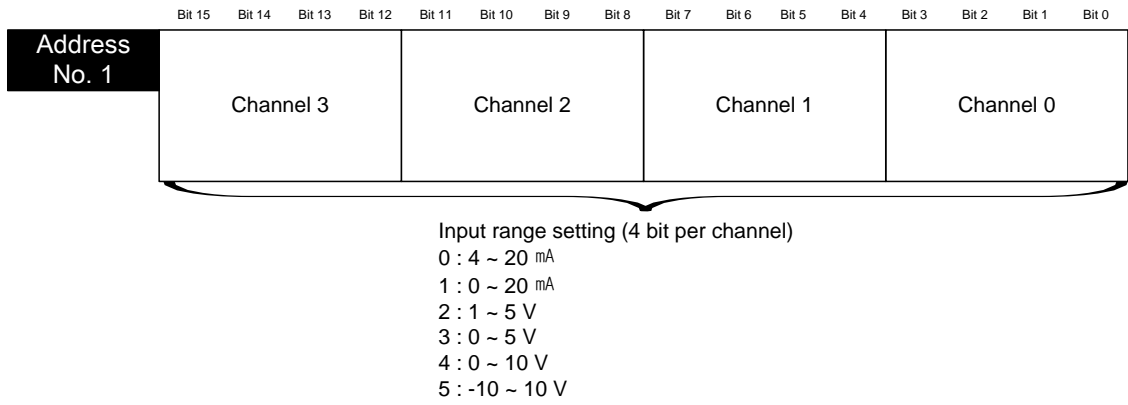

3) Output range setting

- (1) The ranges of analog output voltage are DC 1~5V, DC 0~5V, DC 0~10V, DC -10~10V. And the ranges of analog output current are DC 4 ~ 20mA, DC 0 ~ 20mA
- (2) When the output range is not set or it is entered out of setting values, it is handled as range of DC 1~5V (in case of voltage) or DC 4~20mA (in case of current).

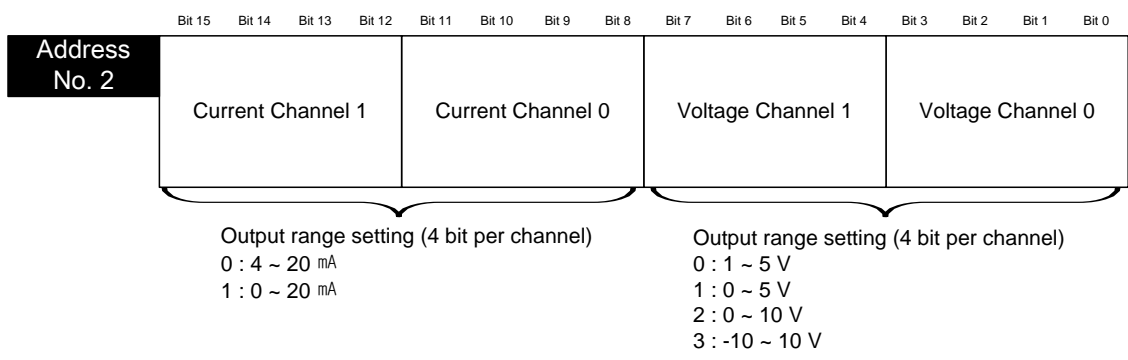

4) Input/Output data type setting

- (1) The range of digital output/input data for analog input/output can be specified for respective channels.
- (2) If the input/output data range is not specified, the range of all the channels will be set to 0 ~ 16000.

	Bit 15	Bit 14	Bit 13	Bit 12	Bit 11	Bit 10	Bit 9	Bit 8	Bit 7	Bit 6	Bit 5	Bit 4	Bit 3	Bit 2	Bit 1	Bit 0
Address No. 3	Current Output Channel 1	Current Output Channel 0	Voltage Output Channel 1	Voltage Output Channel 0	Input Channel 3	Input Channel 2	Input Channel 1	Input Channel 0								

<p>Input / Output data type setting (2 bits per channel)</p> <p>00 : 0 ~ 16000</p> <p>01 : -8000 ~ 8000</p> <p>10 : Precise value</p> <p>11 : 0 ~ 1000</p>	<p>-In case of precise value</p> <p>4 ~ 20mA: 4000 ~ 20000</p> <p>0 ~ 20mA: 0 ~ 20000</p> <p>1 ~ 5V: 1000 ~ 5000</p> <p>0 ~ 5V: 0 ~ 5000</p> <p>0 ~ 10V: 0 ~ 10000</p> <p>-10 ~ 10V: -10000 ~ 10000</p>
--	---

5) Filter constant setting

- (1) When the filter constant is specified with 0, the filter will not be operated.
- (2) If the filter constant is not specified with anything, it can't filter and it will be handled in 0.

	Bit 15	Bit 14	Bit 13	Bit 12	Bit 11	Bit 10	Bit 9	Bit 8	Bit 7	Bit 6	Bit 5	Bit 4	Bit 3	Bit 2	Bit 1	Bit 0
Address No. 4	Input channel 0 filter constant (0 or 4 ~ 64000 ms)															
Address No. 5	Input channel 1 filter constant (0 or 4 ~ 64000 ms)															
Address No. 6	Input channel 2 filter constant (0 or 4 ~ 64000 ms)															
Address No. 7	Input channel 3 filter constant (0 or 4 ~ 64000 ms)															

6) Average process method setting

- (1) When setting average process, the average process method is selected among time average, count average, moving average, or weighted average.
- (2) If setting average process is not specified, all channels will not handle the average process.

	비트15	비트14	비트13	비트12	비트11	비트10	비트9	비트8	비트7	비트6	비트5	비트4	비트3	비트2	비트1	비트0
Address No. 8	Input Channel 3				Input Channel 2				Input Channel 1				Input Channel 0			

<p>Designation of average processing method(4bit per channel)</p> <p>0 : Sampling processing</p> <p>1 : Time average processing</p> <p>2 : Count average processing</p> <p>3 : Moving average processing</p> <p>4 : Weighted average processing</p>	
---	--

7) Average value setting

- (1) set to range of 4 ~ 16,000 as time average value.
- (2) set to range of 2 ~ 64,000 as count average value.
- (3) set to range of 2 ~ 100 as moving average value.
- (4) set to range of 1 ~ 99 as weighted average value.
- (5) If average process method is set to 0(sampling process) and average value is set to 0, the input channel will not do average process, and sampling value will be output.

Address No. 9	Input channel 0 average value
Address No. 10	Input channel 1 average value
Address No. 11	Input channel 2 average value
Address No. 12	Input channel 3 average value

Input channel average value setting
 - Time average : 4 ~ 16000 [ms] - Moving average : 2 ~ 100 [samples]
 - Count average : 2 ~ 64000 [times] - Weighted average : 1~99 [%]

8) Hold last value setting

- (1) In case that hold last value function is set at the same time, if the invalid value is come, the late valid value will only be retained. For example, firstly, it is operated with 4~20mA. Secondly, 10mA comes in. Finally, the signal is immediately falling down to 3mA without falling down the current continually. In this case, relevant channels will retain the output value of 10mA.
- (2) When this function is set, digital output value related with actual range of analog input is only shown. Refer to the actual range of the analog from "chapter 1.3.1".
 For the detailed usage, refer to 'chapter 1.5.5 Hold Last Value Function'.
- (3) Setting of hold last value is as below.

Address No. 13	Bit 15	Bit 14	Bit 13	Bit 12	Bit 11	Bit 10	Bit 9	Bit 8	Bit 7	Bit 6	Bit 5	Bit 4	n Bit 3	n Bit 2	n Bit 1	n Bit 0
	-	-	-	-	-	-	-	-	-	-	-	-	C 3	C 2	C 1	C 0

Designation of used channel
 Bit On (1): Enable
 Bit Off (0): Disable

9) Output status setting

- (1) When the PLC system is stopped, set the analog output status.
- (2) When the output status setting is not specified, output the previous value.

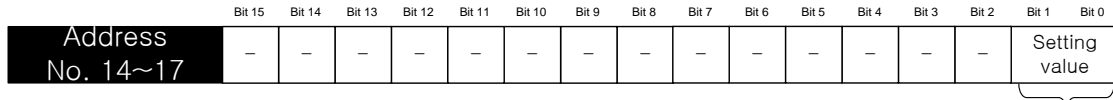

Set the output status (2 bits)
 00 : Previous value output
 01 : Min value output
 10 : Mid value output
 11 : Max value output

Address	Details	Setting
14	Voltage channel 0 output status setting	Input data type setting (bit) → 00: Previous value → 01: Min value → 10: Mid value → 11: Max value
15	Voltage channel 1 output status setting	
16	Current channel 0 output status setting	
17	Current channel 1 output status setting	

10) Interpolation method setting

Shows the setting of the interpolation method of each channel.

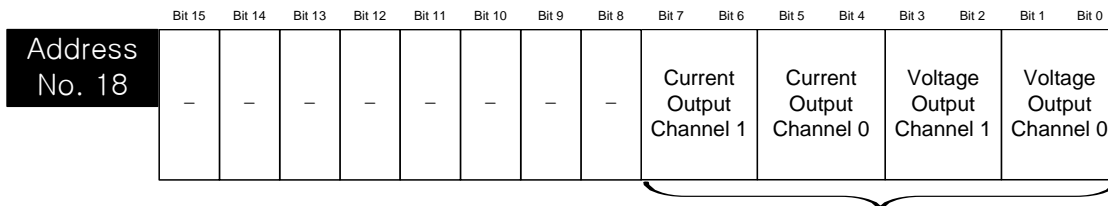

Interpolation method setting (2 bits per channel)
 00 : Disable
 01 : Linear interpolation
 10 : S curve interpolation

11) Interpolation period setting

Shows the setting of interpolation time of each channel.

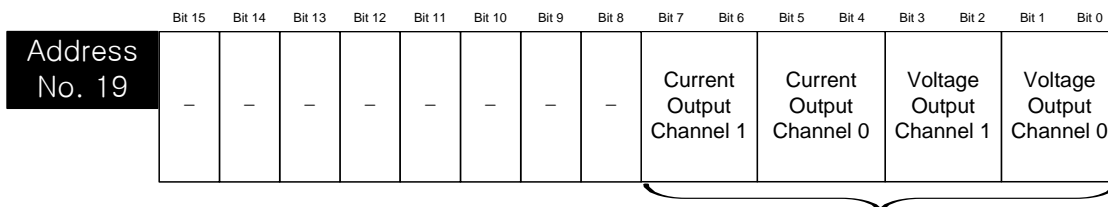

Interpolation time setting (2 bits per channel)
 00 : 10[ms]
 01 : 100[ms]
 10 : 1[s]
 11 : 60[s]

12) Interpolation operation value

Shows the interpolation operation value of each channel.

	Bit 15	Bit 14	Bit 13	Bit 12	Bit 11	Bit 10	Bit 9	Bit 8	Bit 7	Bit 6	Bit 5	Bit 4	Bit 3	Bit 2	Bit 1	Bit 0
Address No. 20	Voltage Output Channel 0 Interpolation operation value															
Address No. 21	Voltage Output Channel 1 Interpolation operation value															
Address No. 22	Current Output Channel 0 Interpolation operation value															
Address No. 23	Current Output Channel 1 Interpolation operation value															

13) Error code

(1) Shows the error code of each channel.

	Bit 15	Bit 14	Bit 13	Bit 12	Bit 11	Bit 10	Bit 9	Bit 8	Bit 7	Bit 6	Bit 5	Bit 4	Bit 3	Bit 2	Bit 1	Bit 0
Address No. 24	Error information of setting															

Type	Error code	LED sign	Details	Priority of error code	Remarks for reference
Error	10#	LED Flickering 1s intervals	Setting error of input channel range	1	# is the number of CH 0~3 * is output type (Voltage output: 0 Current output: 1)
	20#		Setting error of input channel filter value	2	
	30#		Setting error of input channel average value	3	
	4*#		Setting error of output channel range	4	
	5*#		Setting error of output channel digital input value range	5	
	6*#		Setting error of output channel interpolation method range	6	

(2) When errors of two or more are caused, the high priority error code is saved. And when the same error code is caused in channels of two or more, the error code of low channel number is saved preferentially. In case of that the errors are occurred at the same time in voltage output channel and current output channel, the error code of voltage output channel is saved preferentially.

14) System area (after No. 25)

(1) The system area (after No. 25) is prohibited for reading / writing.

 Caution
<p>▶ Do NOT handle this area. If this area is changed, the product can malfunction or be broken.</p>

1.11 Example Program

(1) Setting I/O parameter

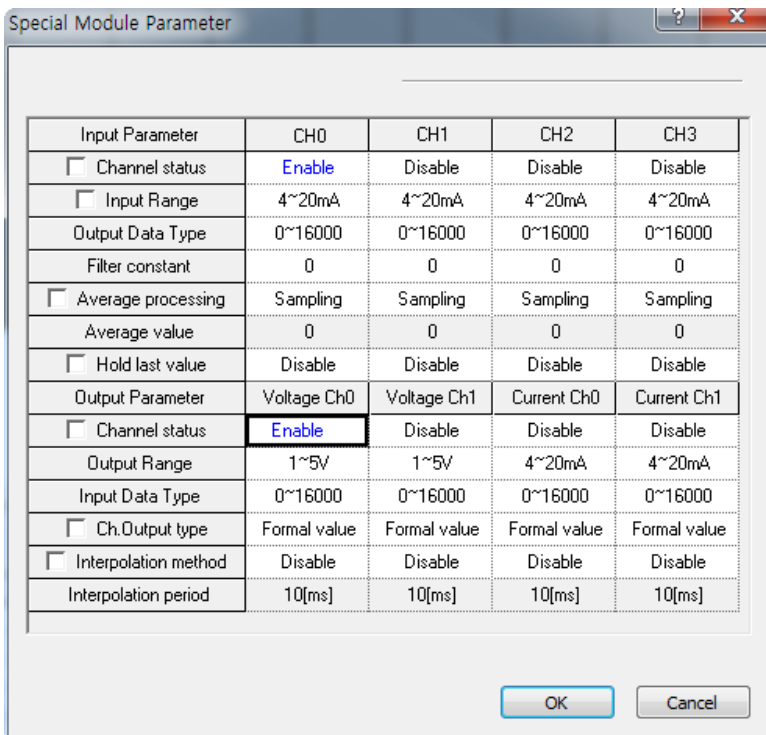
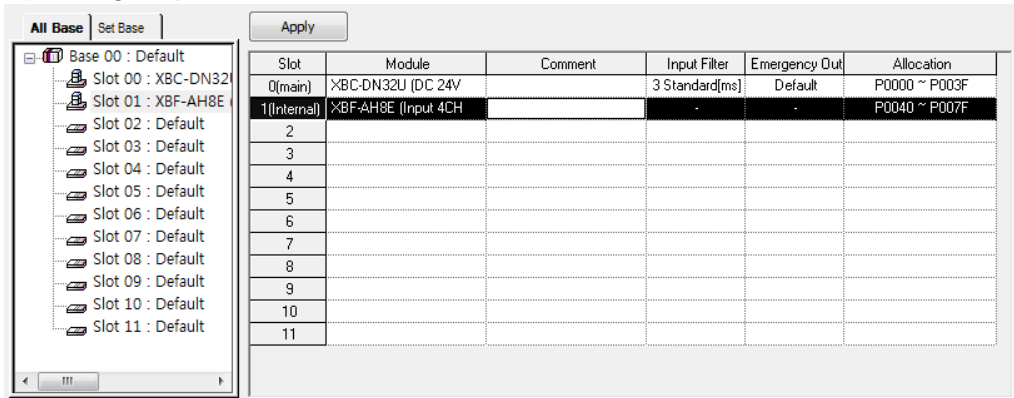

- 1) The input channel 0 is set with operation channel and the range is set with 4~20mA.
- 2) The voltage output channel 0 is set with operation channel and the range is set with 1~5V.

(2) Example program

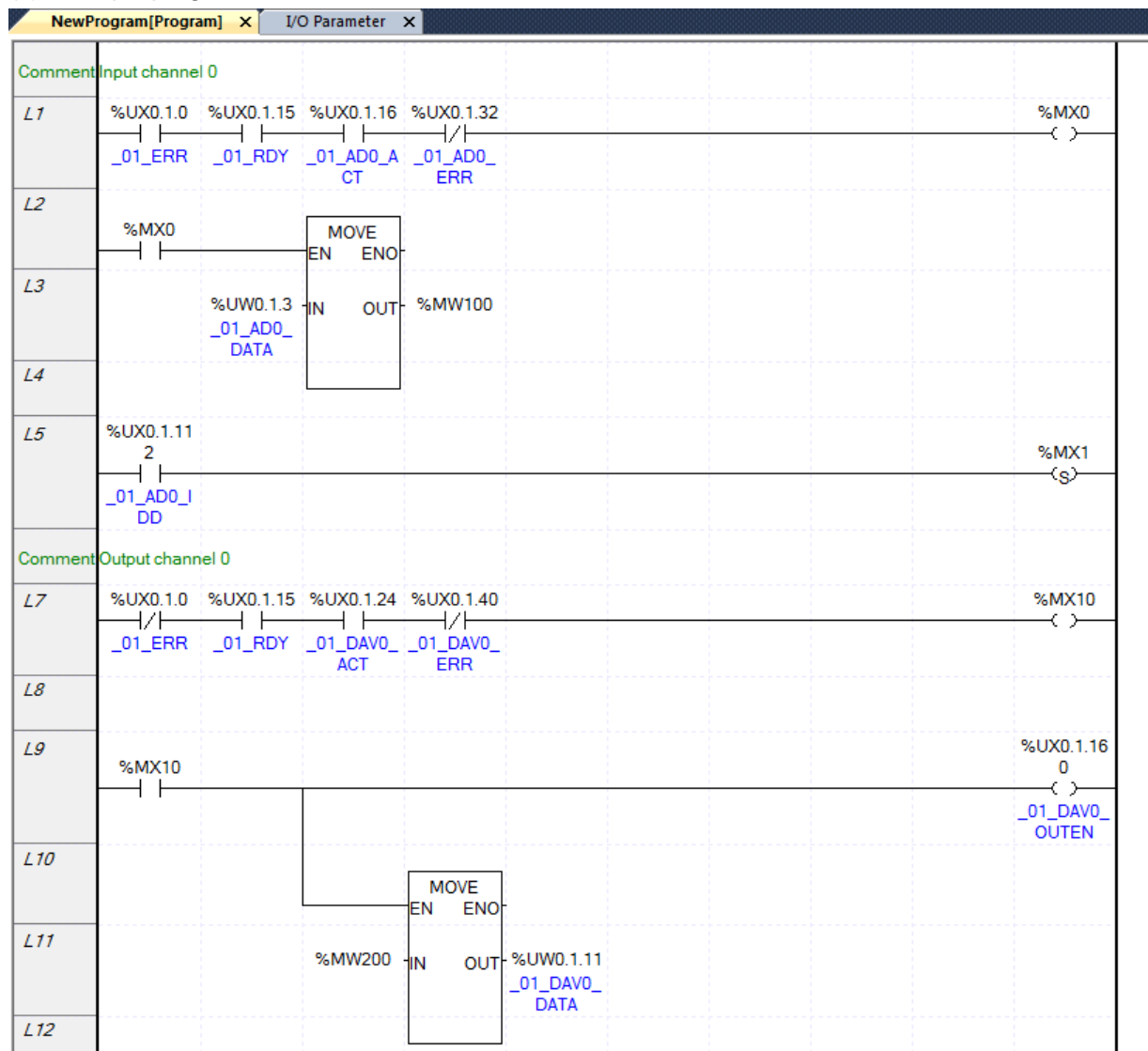

(a) Example of input program

- 1) The '%MX0' is on while the module normally operates.
 - %UX0.1.0(Module Error) = Off
 - %UX0.1.15(Module Ready) = On
 - %UX0.1.16(Channel 0 Run) = On
 - %UX0.1.32 (Channel 0 Error) = Off
- 2) When the 'M0000' is on, conversion value (U01.03) of CH0 is moved to the 'D00100'.
- 3) If the error is caused on CH0, U01.07.0 Bit(CH0 disconnection) will be on and the 'M00001' will be on.

(b) Example of output program

- 1) The '%MX10' is on while the module normally operates.
 - %UX0.1.0 (Module Error) = Off
 - %UX0.1.15 (Module Ready) = On
 - %UX0.1.24 (Voltage Output Channel 0 Run) = On
 - %UX0.1.40 (Voltage Output Channel 0 Error) = Off
- 2) When the 'M0010' is on, voltage channel 0 output status(%UX0.1.160) is on, and the output is permitted.
- 3) If 'M00010' is on, 'D00200' data is moved to voltage channel 0 output value(%UW0.1.11)and then it is output.

1.12 Troubleshooting

The chapter describes diagnostics and measures method in case of any trouble occurs during use of embedded analog module.

1.12.1 LED Indication by Errors

Embedded analog module has two LEDs and it is possible to check whether it had any error with the indication of LEDs.

Item	Normal Status	When CH is disconnected	When parameter setting is error	When external power (DC24V) is not supplied
AD LED	On	Flickering 1s intervals	Flickering 1s intervals (input parameter setting error)	Flickering 0.4s intervals for AD LED and DA LED
DA LED	On	Flickering 1s intervals (Output range: 4~20mA or 0~20mA)	Flickering 1s intervals (output parameter setting error)	
Module Operation	Normal operation Operation of all functions	Operation of all functions Shows minimum input value.	Operation of all functions with default parameter	- operation flags, error flags and disconnection flags for all channels are off. -AD conversion value is 0 or it is retained previous value. -DA output signal is 0.
Measure	-	Check wiring	Check parameter setting	Check DC24V wiring and supply power

1.12.2 Check the Embedded Analog Module

The status of embedded analog module can be checked through the system monitor of XG5000.

1) The order of execution

It can be implemented through one of the methods among next items.

- (1)[Monitor] -> [System Monitor] -> Click the right button of mouse on the painting of module.-> [Module Information]
- (2)[Monitor] -> [System Monitor] -> Double click the painting of module
- (3)[Monitor] -> [Special Module Monitor] -> Embedded Analog Module Selection ->Click the module information
- (4)[Online] -> [I/O Information] -> Embedded Analog Module Selection -> Click the details
- (5)[Online] -> [I/O Information] -> Embedded Analog Module Double click

2) Module information

- (1) OS Version: OS version of module is shown.
- (2) OS Update Date: The OS prepared date of module is shown.
- (3) Module status: The present error code is shown.

1.12.3 Troubleshooting

1) The AD or DA LED are turned off.

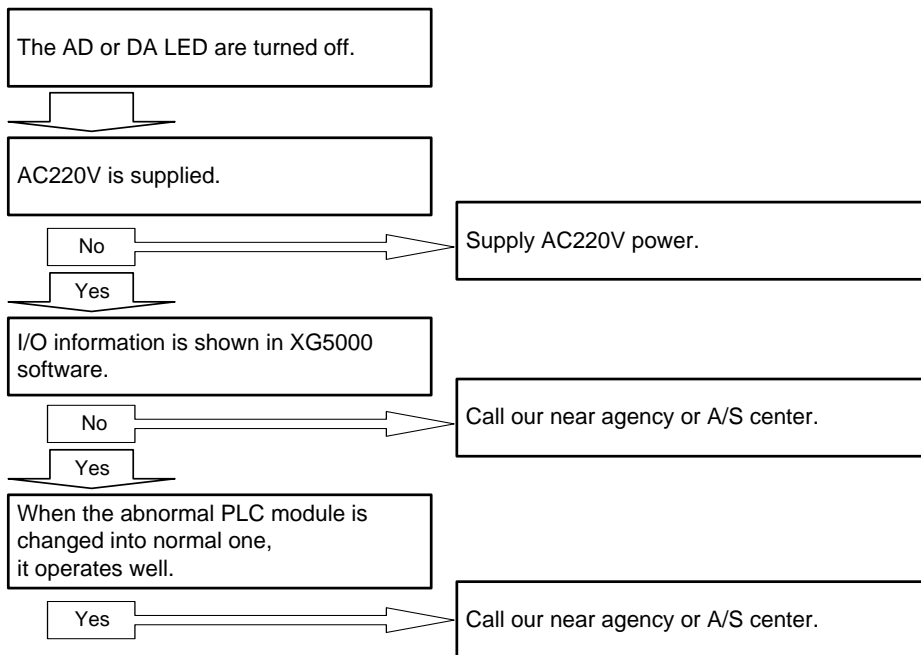

2) The LED is flickering.

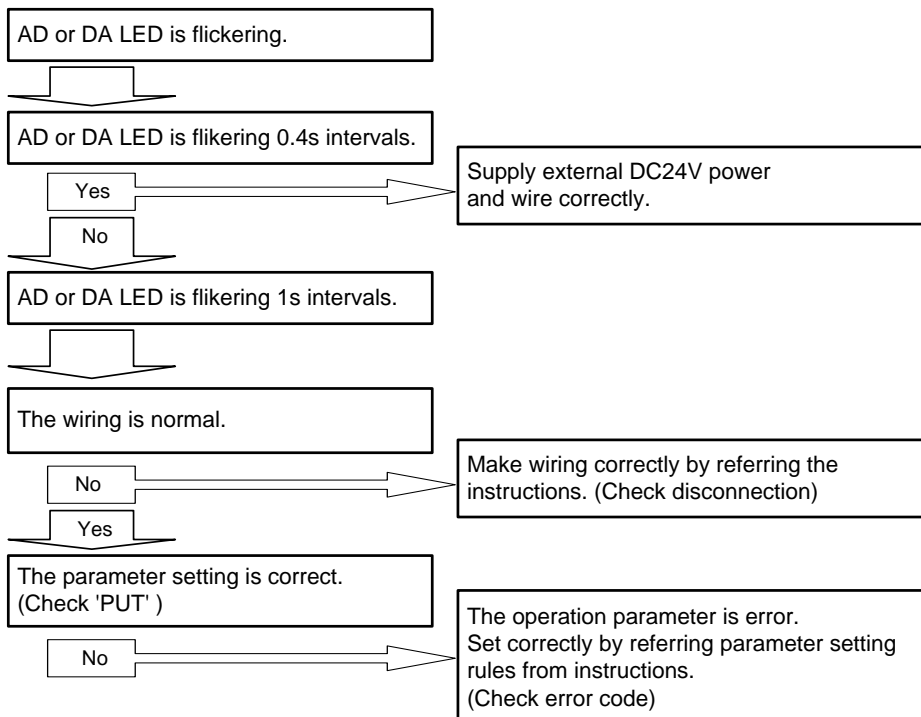

3) The analog input value is abnormal.

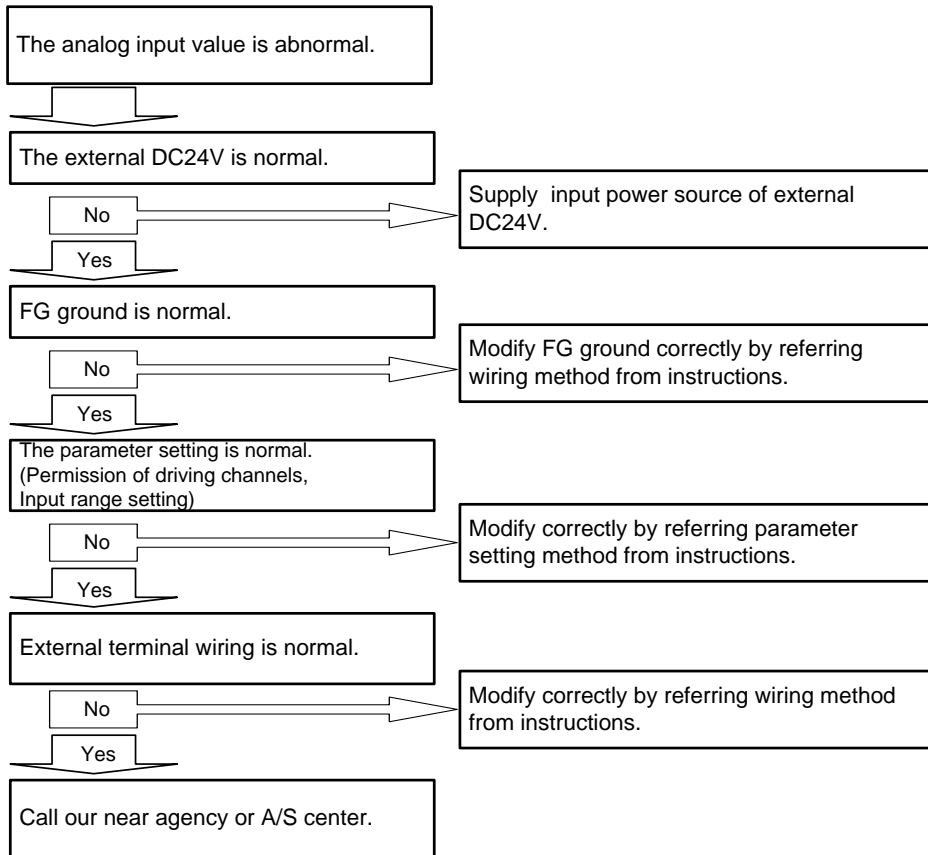

4) The analog output value is abnormal.

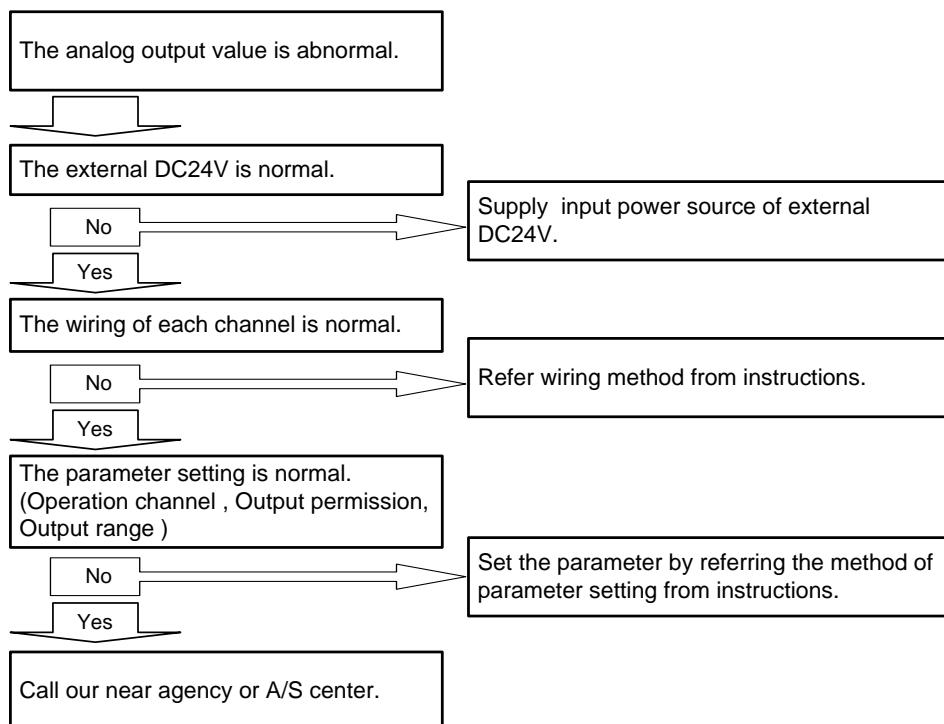

Part 5 Built-in communication functions

Part 5. Built-in communication functions describes the specifications, performance and operation methods of 2port FEnet and RS-232C, RS-485 communication, Web server function embedded in XGB high performance small-sized PLC basic unit.

Chapter 1 Built-in FEnet communication

1.1 Outline

Ethernet is the international standard registered to IEEE (Institute of Electrical and Electronics Engineers), which controls data transfer through CSMA/CD (Carrier Sense Multiple Access/Collision Detection).

Ethernet can transmit data at the speed of 10 Mbps and 100 Mbps and it is stated as 'Fast Ethernet' in the standard. The speed of Fast Ethernet can be expressed as 10 BASE-T, 100 BASE-T. 'T' means the twisted pair wire. In the case of 100 BASE-T, for stable communication with high speed, the specification of the cable to be used is defined and standardized cables are recommended.

The built-in FEnet of XGB high performance small-sized PLC basic unit has various applications based on the standard so it provides excellent functions and performance for a user.

Notice

This chapter describes the functions of 2 ports FEnet embedded in XGB high performance small-sized PLC basic unit. For expansion communication modules, refer to the manual of each module.

1.1.1 Characteristics

XGB high performance basic unit's built-in FEnet provides 2 ports with a switch so a user can easily configure various topologies without other devices. In addition, it supports the FTP (File Transfer Protocol) function and you can access to the SD card through FTP to download the file.

The built-in FEnet's main characteristics are as below.

- 1) Supporting IEEE 802.3u standard
- 2) Supporting high speed link for high-speed data communication between LS ELECTRIC modules
 - Providing the parameter setting program (XG5000)
 - Transmission of the maximum 32 blocks X 200 words, reception of the maximum 32 blocks X 200 words, transmission/reception of maximum 64 blocks X 200 words)
- 3) 4 modules and communications are maximally available apart from the high speed link.
- 4) Supporting the loader service (XG5000) through Ethernet

- Dedicated TCP/IP PORT: 2002 allocations
- 5) Easy connection with other companies' systems through P2P communication and XG5000
 - Variable READ/WRITE service is available: Using the Dynamic Connection functions
- 6) Auto Negotiation
 - Supporting 10/100BASE-TX media auto setting
- 7) Auto-MDIX (Using HP Auto-MDIX)
 - Function to assort the cross cable and straight cable automatically
- 8) Supporting the SD card access through FTP
 - You can download the data log file through FTP client in a remote site.
- 9) 2 ports interface with a built-in switch
 - Line topology configuration is available.
 - Supporting the Auto-Forwarding function
- 10) Supporting various communication functions
 - System access through public network
 - Supporting LS ELECTRIC protocol (XGT) and other companies' protocols (Modbus TCP/IP) (dedicated service)
 - Supporting the simple and convenient client function for communication between LS ELECTRIC communication modules and communication with other companies' modules
 - XGT, Modbus TCP, user-defined P2P client function
 - Providing the host Enable table for upper PC (MMI) and communication security
 - Supporting Dynamic Connection/Disconnection through P2P service
- 11) Providing various diagnosis functions, status information of modules and network
 - Status of the CPU module
 - Status of communication modules
 - Status of communication services (high speed link, dedicated service, P2P)
 - Providing the PING function to verify the presence of other modules
 - Providing packet types received by LS ELECTRIC communication modules and packet reception rate per minute (network load can be estimated)
 - Providing the diagnosis function of communication modules through the network
 - Providing auto-scan function that provides information on the company's modules connected within the network (except XBL-EMTA)

1.2 Specifications

1.2.1 Performance Specifications

1) Transmission Specifications

Items		Specifications	Remarks
Transmission specifications	Transfer rate	Auto/10Mbps/100Mbps	
	Transfer mode	Base band	
	Flow control	HALF/FULL	
	Modulation method	NRZI	4B/5B coding
	Transformer CT	1:1	node– hub
	Maximum distance between nodes	100 m	
	Minimum distance between nodes	1m or more ^(note1)	
	Maximum segment length	-	
	Maximum number of nodes	Hub access	
	Node distance	-	
	Maximum protocol size	Data 512 bytes	
	Communication zone access method	CSMA/CD	
	Frame error check	CRC 32	
	Communication channel	1 Channel, 2 Port	
	Ethernet switch	Unmanaged Switch built-in	

*Note1) When using a cable of less than 1 m, the SNR (Signal to Noise Ratio) decreases due to the influence of reflected waves, which may cause Link Down or packet loss.

2) Maximum number of channels

Items	Specifications	Remarks
Maximum server access channel	21 channels	XGT dedicated or Modbus: 16 channels Remote 1/2-stage: 1channel(independently) FTP: 1 channel HTTP: 4 channel Auto-Scan: 2 channel

3) Performance specifications by communication service

Items		Specifications			
		Driver	Communication method	Port No.	Remarks
FUNCTION	Dedicated	XGT server	TCP/IP	2004	<ul style="list-style-type: none"> ▪ Up to 16 channels ▪ Up to 512 bytes
			UDP/IP	2005	
		Modbus TCP server	TCP/IP	502	
	High speed link	-	UDP/IP	2006	<ul style="list-style-type: none"> ▪ Up to 64 blocks ▪ 200 words per block
	P2P	XGT client	TCP/IP	2004	<ul style="list-style-type: none"> ▪ Up to 15 channels ▪ Up to 512 bytes
			UDP/IP	2005	
		Modbus TCP client	TCP/IP	502	
		User-defined frame	TCP/IP	Customized	
	Remote	Server	TCP/IP	2002	▪ Up to 1channel
		Client	TCP/IP	2002	▪ Up to 1channel
FTP	Server	TCP/IP	30000 (data) 21 (control)	▪ Up to 1channel	
Auto-Scan	-	UDP/IP	2007(list) 2008(information)	▪ Up to 2channel	
Web server	Server	TCP/IP	80	▪ Up to 4channel	

4) Performance specifications of diagnosis function

Items		Specifications	
Diagnosis function	Information of built-in communication functions	high speed link exchange number/whether using DHCP IP address/MAC address module status/presence of system parameters Group status/media setting value hardware/software version	
	Status by service	Dedicated service	Number of transmitted packets/ Number of received packets / Number of error packets / status drive setting
		High speed link	Number of transmitted/received packets high speed link flag (RUN, link, Mode, Status, TRX, Error)
		P2Pservice	Connection status / service status service count / error count
	Media information	Total number of received packets	BROAD, MULTI, UNI, UDP, ARP, packet drop
		Packet rate per second	
	Ping Test		IP Address / Number of settings / Timeout
Auto-Scan		Available	

5) Available PLC Area

(1) XBC Series(MK type)

AREA	Device Type	Size(Word)	Remark
P	P0 – P2047	2048	Read, Write Enable
M	M0 – M2047	2048	Read, Write Enable
K	K0 – K8191	8192	Read, Write Enable
F	F0 – F219	200	Read Enable
	F200 – F2047	1848	Read, Write Enable
T	T0 – T2047	2048	Read, Write Enable
C	C0 – C2047	2048	Read, Write Enable
L	L0 – L4095	4096	Read, Write Enable
N	N0 – N10239	10240	Read Enable
D	D0 – D19999	20000	Read, Write Enable
U	U00.00 – U0B.31	384	Read, Write Enable
Z	Z0 – Z127	128	Read, Write Enable
R	R0 – R16383	16384	Read, Write Enable

(2) XEC Series(IEC type)

AREA	Device Type	Size(Word)	Remark
I	%IW0.0.0 ~ %IW15.15.3	1024	Read, Write Enable
Q	%QW0.0.0 ~ %QW15.15.3	1024	Read, Write Enable
M	%MW0 ~ %MW16383	16384	Read, Write Enable
W	%WW0 ~ %WW32767	32768	Read, Write Enable
R	%RW0 ~ %RW16383	16384	Read, Write Enable

1.2.2 Names and roles of built-in FEnet parts

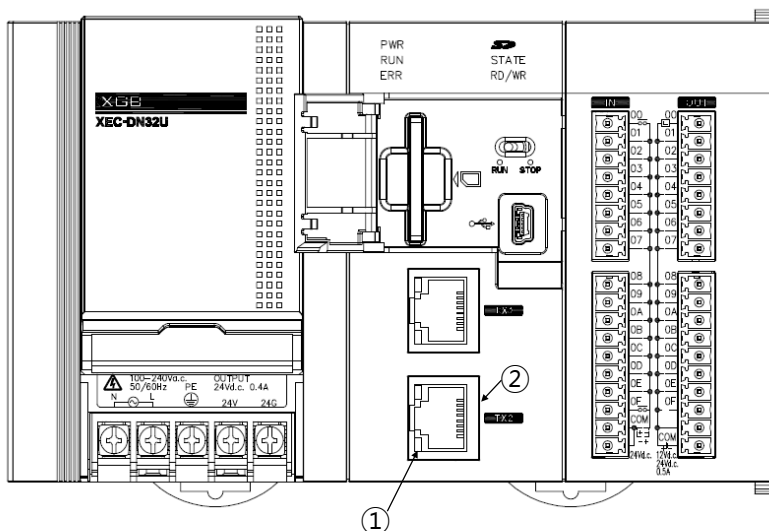

No.	Name	Details																								
①	LED display part	Displays the status of modules and communication.																								
		<table border="1"> <thead> <tr> <th>Item</th> <th>Color</th> <th colspan="3">Operation details of each status</th> </tr> </thead> <tbody> <tr> <td rowspan="3">LINK/ACT</td> <td rowspan="3">Yellow</td> <td>ON</td> <td>Normal connection</td> <td>Linked with the connected device normally</td> </tr> <tr> <td>OFF</td> <td>Connection error</td> <td>No connected device</td> </tr> <tr> <td>Flickering</td> <td>During communication</td> <td>Flickering in case RX, TX occur</td> </tr> <tr> <td rowspan="2">SPEED</td> <td rowspan="2">Green</td> <td>ON</td> <td>100BASE-T</td> <td>In progress at 100Mbps</td> </tr> <tr> <td>OFF</td> <td>10BASE-T</td> <td>In progress at 10Mbps</td> </tr> </tbody> </table>	Item	Color	Operation details of each status			LINK/ACT	Yellow	ON	Normal connection	Linked with the connected device normally	OFF	Connection error	No connected device	Flickering	During communication	Flickering in case RX, TX occur	SPEED	Green	ON	100BASE-T	In progress at 100Mbps	OFF	10BASE-T	In progress at 10Mbps
		Item	Color	Operation details of each status																						
		LINK/ACT	Yellow	ON	Normal connection	Linked with the connected device normally																				
				OFF	Connection error	No connected device																				
Flickering	During communication			Flickering in case RX, TX occur																						
SPEED	Green	ON	100BASE-T	In progress at 100Mbps																						
		OFF	10BASE-T	In progress at 10Mbps																						
②	FEnet communication connector	FEnet communication connector (RJ 45)																								

1.2.3 Cable Specifications

1) Classification of cables

For 100 BASE-TX, 'T' indicates 'a twisted wire is applied' and 'X' indicates the kinds of twisted wires for classification. 'TX' uses an unshielded twisted pair wire 5 (UTP 5) or shielded twisted pair wire ; 'T2' uses an unshielded twisted pair wire 3 (UTP 3); 'T4' uses the unshielded twisted pair wire 3, 4, 5 (UTP 3, 4, 5). The built-in FEnet specifies 100 BASE-TX and adopts the UTP cables of more than Category 5.

The cables can be classified as below.

Items	Names	Remarks
UTP (or U.UTP)	Cable for unshielded high speed signal	Up to 200MHz Sound + information (Data)+low-grade video signal
FTP (or S.UTP)	Cable with shielded core only	Up to 100MHz Considering electromagnetic interference (EMI) and electronic stability Sound + information (Data)+low-grade video signal
STP (or S.STP)	Dual Shielded, pair individual twisted and cable with shield core only	Up to 500MHz Sound + information (Data)+Video signal Substitute for the coaxial cable of 75Ω

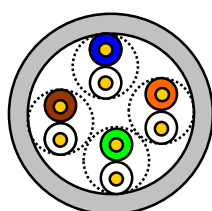

-UTP-

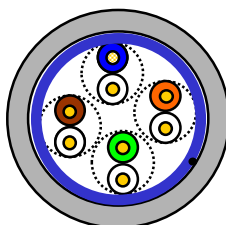

-FTP-

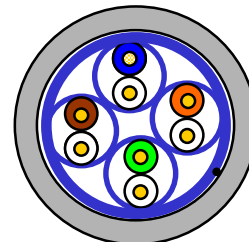

-STP-

Notice

XGB FEnet does not support AUI (10BASE-5).

- (1) In the case of twisted pair cable unit (more than Category 5) adopts the hub of 100Mbps and it can be used with the zone of 10Mbps (less than Category3) but at this time, the network speed is limited to 10Mbps so be careful for system installation.
- (2) Both twisted cables and straight cables can be applied.
- (3) UTP : Unshielded Twisted Paired Copper Cable
 - FTP : (Overall) Foiled Twisted Paired Copper Cable
 - STP : (Overall) Shielded (and Shielded Individually Pair)Twisted Paired Copper Cable
- (4) Patch Cable (or Patch Cord)

In order to enhance the UTP 4-paired cable's flexibility, the conductor with twisted wire can be used instead of a solid conductor; used standard specification and material is Un-coated AWG 24 (7/0203A). Namely, the diameter of an element wire is 0.203mm and the element wire is standardized with the structure of 1+6 and it is made of annealed copper wire.

2) Classification by using frequency

Classification	Using frequency (MHz)	Transfer rate (Mbps)	Use
Category 1	Sound frequency	1	▪Telephone network (2Pair)
Category 2	4	4	▪Multi-Pair communication cable
Category 3	16	16	▪Telephone network + computer network
Category 4	20	20	▪Computer network transfer rate Up ▪Low-loss communication cable
Category 5 and expanded category 5	100	100	▪Digital telephone network +computer network ▪Low-loss, broadband cable

Notice

Now, Category 3, 5, En-Category 5 and Category 6 are widely used domestically and internationally. Category 4 disappeared due to emergence of Category 5 and Category 7 that is the STP structure is still at a development stage worldwide.

3) Example of Category 5 twisted pair cable (UTP) (CTP-LAN5)

Items	Unit		Value
Conductor resistance (Max.)	Ω/km		93.5
Insulation resistance (Min.)	MΩ·km		2,500
Withstand voltage	V/minute		AC 500
Characteristic impedance	Ω (1~100MHz)		100 ± 15
Attenuation	Less than dB/100m	10MHz	6.5
		16MHz	8.2
		20MHz	9.3
Near-end crosstalk attenuation	Less than dB/100m	10MHz	47
		16MHz	44
		20MHz	42

<UTP cable specifications>

1.3 Specifications of installation and a trial run

1.3.1 Example of FEnet installation

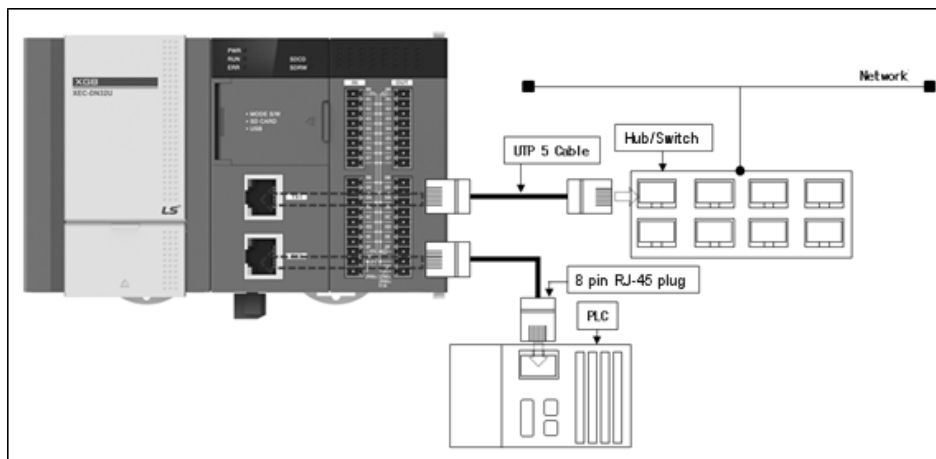

1.3.2 Instructions to install cables

In the case of 10/100 BASE-TX, the maximum length between nodes is 100m (distance between this module and the hub). Generally, a hub uses the straight cable made of twisted transmission (TD) and reception (RD) internally. If you connect these 2 basic units, they can be used regardless of cable types since the built-in FEnet interface supports Auto-MDIX.

You can connect the signal lines of straight cables and cross cables as below.

(1) Straight cable

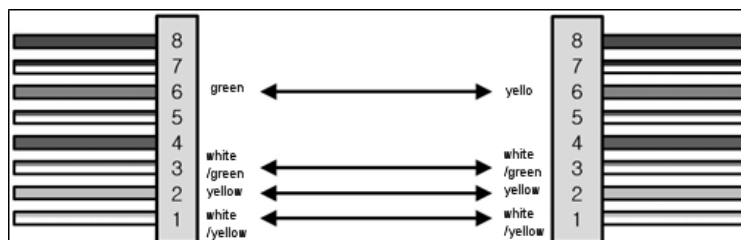

(2) Cross cable

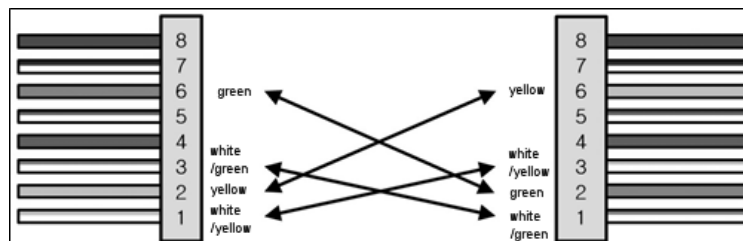

Notice

- (1) Separate the hub's power supply from the PLC's power supply.
- (2) For termination and manufacture, installation of cables, contact the professional manufacturers.
- (3) The Auto-MDIX function runs only when the Auto-Negotiation is set up.

1.3.3 Instructions to install the UTP

Use the UTP cable that meets the characteristics of Category-5. Be careful not to exceed the cable's tensile force by constraint during wiring. When stripping the cable's sheath, strip it by the length to be connected and be careful not to damage the insulator.

When installing the UTP cable, keep the proper distance between the EMI source and the UTP cable.

Conditions	Minimum separation distance		
	Less than 2.0 kVA	2.5 kVA	More than 5.0 kVA
In case the unshielded power line or electric equipments are open or close to the non-metallic pipes.	127 mm	305 mm	610 mm
In case the unshielded power line or electric equipments are open or close to the buried metallic pipes.	64 mm	152 mm	305 mm
In case the power line of the buried metallic pipes (or equivalent shielded ones) is close to the buried metallic pipes.	-	76 mm	152 mm
Transformer /electric motor fluorescent light	1,016 mm / 305 mm		

< Separation distance by conditions when installing the UTP cable >

Items	Color	Operation details of each status		
		LINK/ACT	Yellow	ON
OFF	Connection error			No connected device
Flickering	During communication			Flickering in case RX, TX occur
SPEED	Green	ON	100BASE-T	In progress at 100Mbps
		OFF	10BASE-T	In progress at 10Mbps

1.3.4 How to make a trial run

1) Setting procedures of the product before operation

It describes the installation of the product and procedures before operation. If the installation of the product is completed, install and set up the system based on the below procedures.

Refer to the following items to be checked before operating the system with the built-in FEnet.

2) Communication interface

Items to be checked
Installation and execution, operation of XG5000
Access Status of communication cables (Only when the cable is accessed)

3) Trial run sequence

Startup
<p>Apply the power:</p> <p>(1) Check input power.</p> <p>(2) Check the communication cable access.</p> <p>(3) Apply the power.</p> <p>(4) Check whether the power LED is turned on.</p> <p>(5) Check the LED status of the basic unit</p> <p>→ In case of abnormal status, refer to 'Troubleshooting' of the basic unit manual.</p> <p>(6) Check whether the status of the LINK LED is normal.</p> <p>→ In case the LED is turned off despite connecting the line to the cable, refer to 'Troubleshooting' of the basic unit manual.</p> <p>(7) After setting the system parameters correctly, download them.</p>

4) Instructions for system configuration

When you configure the system with XGB's built-in FEnet, refer to the below for installation.

(1) Check the basic factors required for system configuration and select the proper communication interface.

(2) Choose the dedicated cable for communication modules.

(3) When installing communication cables, check whether the connector pins are damaged or not.

(4) For expansion communication modules besides built-in communication, the maximum of 4 stages can be equipped within the number of stages as below.

(2EA of existing communication expansion modules, 2 EA of high speed communication interfaces for XGB high performance basic unit can be equipped)

The following table shows the number of expansion stages for each basic unit type.

Type	XBC			XEC			XBM
	Super premium	Premium	Standard	Super premium	Premium	Standard	Moduler
Maximum number of expansion stages	10-stage	10-stage	7-stage	10-stage	10-stage	7-stage	7-stage

(5) When installing modules, lock the modules after equipping the relevant slot without accessing the communication cable. In case the device is not locked up, interface error with the basic unit may occur.

5) Instructions for network configuration

- (1) The IP addresses of devices should be different. If the IP addresses are overlapped, communication will not work normally.
- (2) Set up the different exchange numbers for each station to use the high speed link service.
- (3) Use the specified communication cables. Otherwise, communication problems may occur.
- (4) Check whether the cables are disconnected or shorted before installing the communication cables.
- (5) Fix them tightly until the communication cable connector clicks
- (6) In case the cable access is unstable, it may cause serious communicable problems.
- (7) For wiring, separate the communication cables from the power line or inductive noise.

1.4 Configuration of FEnet communication system

XGB's built-in FEnet supports open Ethernet so you can configure the network by connecting with LS ELECTRIC and other companies' PLCs, PCs. Some examples of network system configurations are represented as below.

1.4.1 Mixed network configuration

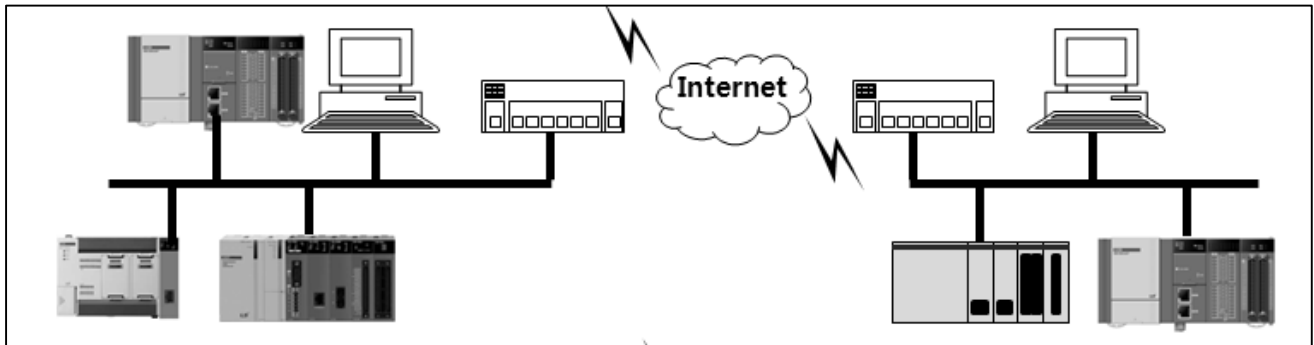

[Fig.1.4.1] System configuration diagram

XGB's built-in FEnet accesses LS ELECTRIC PLC, other companies' PLCs, PCs, etc. through the network. You can configure the system by using dedicated communication, Modbus TCP/IP, user-defined frame, high speed link communication.

1.4.2 Network configuration through XGB PLC

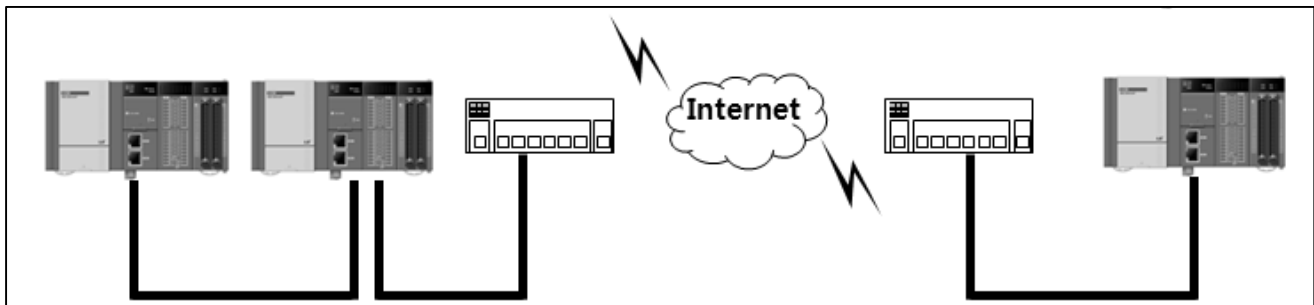

[Fig. 1.4.2] System configuration diagram

XGB's built-in FEnet can access to 1:1 communication or network and perform 1:N communication by using cross cables or straight cables. You can transmit and receive the data through the dedicated services, Modbus TCP/IP, user-defined frame and high speed link communication.

1.4.3 Network configuration through XGB PLC and MMI

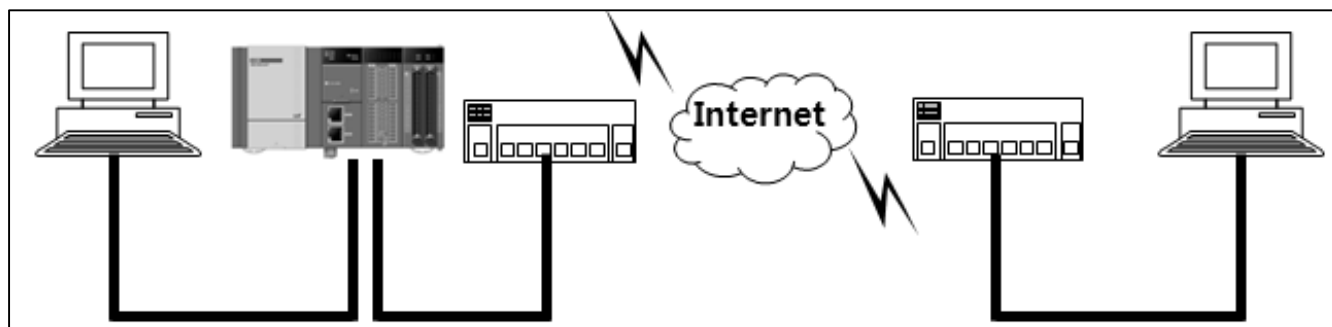

[Fig.1.4.3] System configuration diagram

For communication between XGB's built-in FEnet and the PC, 1:N communication is available by accessing to 1:1 communication or the network using cross cables or straight cables. You can transmit and receive data in the PC by using XG5000 or MMI. In addition, through XG5000, you can make, download, upload the program and parameters and transmit/receive data through dedicated services, Modbus TCP/IP, user-defined frame.

1.4.4 Network configuration between LS ELECTRIC modules

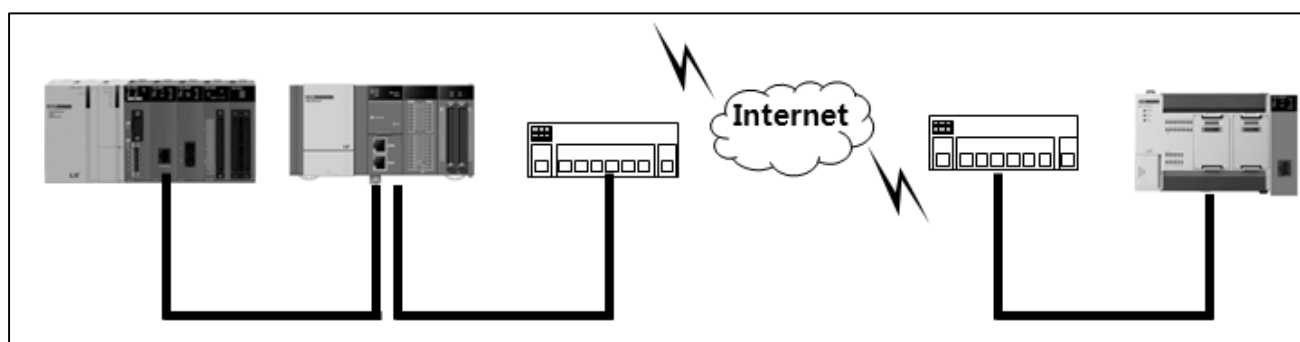

[Fig.1.4.4] System configuration diagram

You can configure the system by using XGB's built-in FEnet and XGK PLC's FEnet I/F expansion modules. 1:N communication is available through 1:1 communication using cross cables or accessing to network. You can transmit and receive the data through the dedicated services, Modbus TCP/IP, user-defined frame and high speed link communication.

1.4.5 Network configuration using XGB PLC and other companies' PLCs

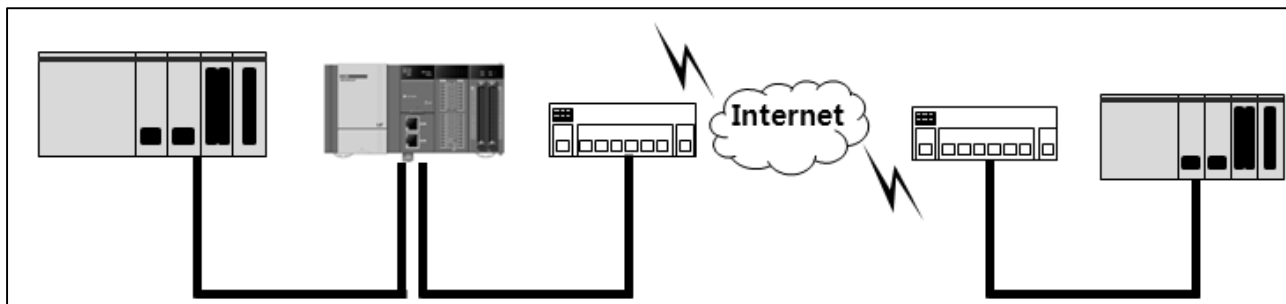

[Fig.1.4.5] System configuration diagram

XGB's built-in FEnet can communicate with other companies' PLCs, HMIs, MMIs. 1:N communication is available through 1:1 communication using cross cables or accessing to network. For communication, the PLCs should have the same protocol.

1.5 Protocols for each service

XGB high performance basic unit's built-in FEnet interface supports Ethernet(open Ethernet), so you can configure the network by connecting with LS ELECTRIC and other companies' PLCs, PCs.

For communication after network configuration, make sure to set up IP, parameters of each PLC, protocols. The protocols supported by the built-in FEnet are XGT dedicated, Modbus TCP/IP, user-defined frame, File Transfer Protocol (FTP).

Each protocol is operated by the server or client and dedicated server, P2P functions communicate based on designated protocols.

Items		Specifications			Remarks
		Driver	Communication method	Port No.	
Communication function	Dedicated	XGT server	TCP/IP	2004	Up to 16channels Up to 512 bytes
			UDP/IP	2005	
		Modbus TCP server	TCP/IP	502	
	P2P	XGT client	TCP/IP	2004	Up to 15channels Up to 32 blocks
			UDP/IP	2005	
		Modbus TCP client	TCP/IP	502	
		User-defined frame	TCP/IP	Customized	
	UDP/IP		Customized		
	FTP	FTP server	TCP/IP	30000, 21	Up to 1channels
	Web server	HTTP	TCP/IP	80	Up to 4channels HTTP 1.1
Auto-Scan	-	UDP/IP	2007 2008	Up to 2channels	

[Table 1.5.1] Protocols by communication functions

1.5.1 XGT dedicated protocol

1) Protocol outline

Dedicated protocols for XGT are the communication protocols for LS ELECTRIC PLC only for communication between LS ELECTRIC modules. You can Read/Write data with commands and communication is available in PC, HMI by using dedicated protocols for XGT. Two communication methods of TCP and UDP can be applied to the dedicated protocols for XGT.

Protocol	Communication Method	Port No.
For XGT only	TCP/IP	2004
	UDP/IP	2005

[Table 1.5.2] Classification of dedicated protocols for XGT

2) Frame structure

(1) XGT dedicated packet's structure through Ethernet

When communicating with dedicated protocols for XGT, MAC, IP header (IP Header), TCP Header and LS ELECTRIC frames containing data are included for Ethernet communication. [Fig. 1.5.1] shows the frame structure for Ethernet communication.

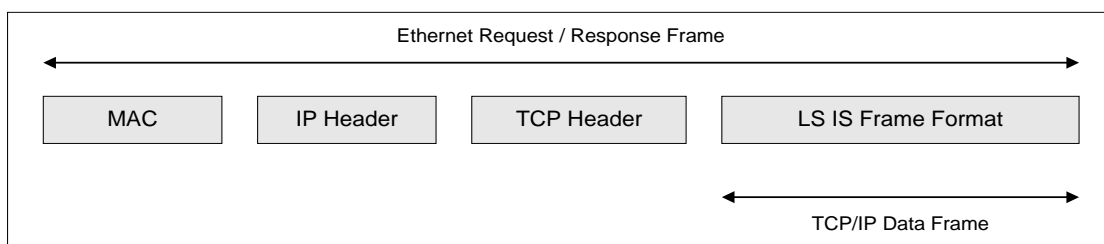

[Fig. 1.5.1] XGT dedicated packet structure through Ethernet

3) Structure of XGT dedicated frame

The LS ELECTRIC frames for data communication include LS ELECTRIC's own data (Company ID), command (Command), data type (Data Type), data (Data). [Fig. 1.5.2] shows the frame form.

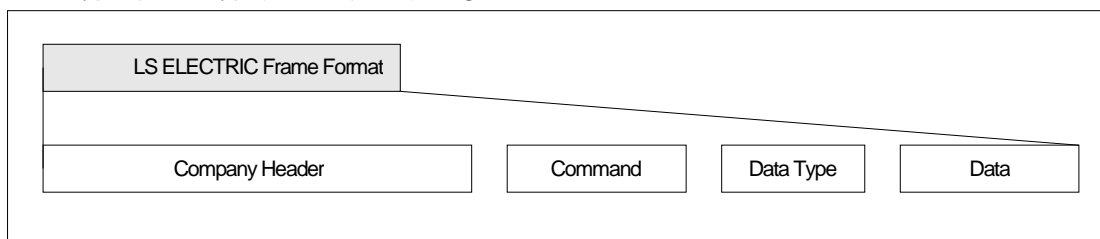

[Fig. 1.5.2] Structure of dedicated frames for XGT

4) Data type of XGT dedicated protocols

(1) Device type

The data types of [Table 1.5.3] are available in the dedicated protocols for XGT. When you designate the devices, '%' (25H) should be attached to the front of string.

('%' is the character indicating the startup of devices)

Data type	Type code value	Flag	Example of application
Bit	h0000	X (58h)	%PX000, %MX000, %LX000, %KX000, %CX000, %TX000, %FX000, %IX0.0.0, %QX0.0.0, %UX00.00.0, etc.
Byte	h0100	B (42h)	PB000, %MB000, %LB000, %KB000, %CB000, %TB000, %FB000, %IB0.0.0, %QB0.0.0, etc.
Word	h0200	W (57h)	%PW000, %MW000, %LW000, %KW000, %CW000, %TW000, %FW000, %DW000, %IW0.0.0, %QW0.0.0, %MW0, %RW0, %WW0, %UW00.00, etc.
D word	h0300	D (44h)	%PD000, %MD000, %LD000, %KD000, %CD000, %TD000, %FD000, %DD000, %ID0.0.0, %QD0.0.0, %MD0, %RD0, %WD0, etc.
L word	h0400	L (4Ch)	%PL000, %ML000, %LL000, %KL000, %CL000, %TL000, %FL000, %DL000, %IL0.0.0, %QL0.0.0, %ML0, %RL0, %WL0, etc.

[Table 1.5.3] Data types of dedicated protocols for XGT

Notice

- (1) In the timer/counter, designating bit means the contact values; designating byte, word values means the current values.
- (2) The data register (D) can be designated as Byte, Word only.
- (3) In the case of byte type command, the address value is doubled compared to the value at the time of designating word. Namely, in the case of D1234, %DW1234 should be applied for word designation but %DB2468 should be applied for byte designation.

5) Commands of XGT dedicated protocols

4 commands are used for XGT dedicated protocols and each command processes Read/Write, Request/Response.

For available data types for each command, individual one can apply bit, byte, word, double word, long word; continuous one can adopt byte only.

Command	Command code	Data format		Processing details
Read	Request: h0000	Individual	h0000	Request on reading data depending on each data type
			h0100	
			h0200	
			h0300	
			h0400	
	Continuous	h1400	Request on reading byte type of variables by block	
Response: h5500	Individual		h0000	Response to the request on reading data
			h0100	
			h0200	
			h0300	
			h0400	
	Continuous	h1400	Response to the request on reading by block	
Write	Request: h5800	Individual	h0000	Request on writing data depending on each data type
			h0100	
			h0200	
			h0300	
			h0400	
	Continuous	h1400	Request on writing byte type of variables by block	
Response: h5900	Individual		h0000	Response to the request on writing data
			h0100	
			h0200	
			h0300	
			h0400	
	Continuous	h1400	Response to the request on writing by block	

[Table 1.5.4] Command types of XGT dedicated protocols

6) Headers and data structures of XGT dedicated protocols

Items	Client (request frame)			Server (response frame)				
	Classification	Details	Size	Classification	Details	Size		
Company header	LS ELECTRIC'S OWN	Company ID 1	10	LS ELECTRIC'S OWN	Company ID 1 Company ID 2	10		
	PLC information	h00~hFF	2	PLC information	h00 ~ hFF	2		
	CPU information	hA0	1	CPU information	hA0	1		
	Frame direction	h33	1	Frame direction	h11	1		
	Frame sequence number	h0000~hFFFF	2	Frame sequence number	h0000~hFFFF	2		
	Length	h0000~h0100	2	Length	h0000~h0100	2		
	Position information	h00~hFF	1	Position information	h00~hFF	1		
	Check Sum	h00~hFF	1	Check Sum	h00~hFF	1		
Command	Command	h5400	Read	2	Command	h5500	Read	2
		h5800	Write			h5900	Write	
Data Type	Data type	h0000	bit	2	Data type	h0000	bit	2
		h0100	byte			h0100	byte	
		h0200	word			h0200	word	
		h0300	Double word			h0300	Double word	
		h0400	long word			h0400	Long word	
		h1400	Continuous			h1400	Continuous	
Data	Reserved area	-	2	Reserved area	-	2		
	Number of blocks	h0100~h1000	2	Error status	h0000~hFFFF	2		
	Variable length (N)	h0400~h1000	2	Data		2		
	Data address	-	N					
	Number of data	h0 (M)00	M					

[Table 1.5.5] Headers and data structures of XGT dedicated protocols

(1) Company ID (LS ELECTRIC'S own number)

The LS ELECTRIC's own number has two types; XGK and XGB PLC use Company ID 1 when they are operated as the client; the Company ID requested by the client is used when they are operated as server. For client, Company ID 1 or Company ID 2 should be used.

Type	Mode	Frame										Remarks
Company ID 1	ASCII	L	S	I	S	-	X	G	T	/n	/n	XGT
	HEX	h4C	h53	h49	h53	h2D	h58	h47	h54	h00	h00	
Company ID 2	ASCII	L	G	I	S	-	G	L	O	F	A	GM,MK
	HEX	h4C	h47	h49	h53	h2D	h47	h4C	h4F	h46	h41	

[Table 1.5.6] LS ELECTRIC's Own Number

Notice

XGB FEnet does not support 'LGIS-GLOFA'header.

It will be supported in the future and you can check version-up status through our website.

7) Example of transmission/reception frames

(1) Request frame for reading variables individually

Items	Type	Frame										Size
Company ID	ASCII	L	S	I	S	-	X	G	T	/n	/n	10
	HEX	0x4C	0x53	0x49	0x53	0x2D	0x58	0x47	0x54	0x00	0x00	
	ASCII	L	G	I	S	-	G	L	O	F	A	
	HEX	0x4C	0x47	0x49	0x53	0x2D	0x47	0x4C	0x4F	0x46	0x41	
PLC Info	HEX	0x00	0x00									2
CPU Info		0xA0										1
Source of Frame		0x33										1
Invoked ID		0x00	0x01									2
Length		0x10	0x00									2
Position		0x00										1
Check Sum		0x09										1
Command		0x54	0x00									2
Data Type		0x14	0x00									2
Reserved		0x00	0x00									2
Block No.		0x01	0x00									2
Variable Length		0x04	0x00									2
Data Address	ASCII	%	M	B	0							4
	HEX	0x25	0x4D	0x42	0x30							
Data Count	HEX	0x02	0x00									2

[Table 1.5.7] Request frame for reading variables individually

(2) Response frame for reading variables individually

Items	Type	Frame										Size
Company ID	ASCII	L	S	I	S	-	X	G	T	/n	/n	10
	HEX	0x4C	0x53	0x49	0x53	0x2D	0x58	0x47	0x54	0x00	0x00	
	ASCII	L	G	I	S	-	G	L	O	F	A	
	HEX	0x4C	0x47	0x49	0x53	0x2D	0x47	0x4C	0x4F	0x46	0x41	
PLC Info	HEX	0x02	0x08									2
CPU Info		0xA0										1
Source of Frame		0x11										1
Invoked ID		0x00	0x01									2
Length		0x0E	0x00									2
Position		0x01										1
Check Sum		0x25										1
Command		0x55	0x00									2
Data Type		0x14	0x00									2
Reserved		0x00	0x00									2
Error State		0x00	0x00									2
Block No.		0x10	0x00									2
Data Count		0x02	0x00									2
Data		0x00	0x00									2

[Table 1.5.8] Response frame for reading variables individually

(3) Request frame for reading variables sequentially

Items	Type	Frame										Size
Company ID	ASCII	L	S	I	S	-	X	G	T	/n	/n	10
	HEX	0x4C	0x53	0x49	0x53	0x2D	0x58	0x47	0x54	0x00	0x00	
	ASCII	L	G	I	S	-	G	L	O	F	A	
	HEX	0x4C	0x47	0x49	0x53	0x2D	0x47	0x4C	0x4F	0x46	0x41	
PLC Info	HEX	0x00	0x00									2
CPU Info		0xA0										1
Source of Frame		0x33										1
Invoked ID		0x00	0x01									2
Length		0x10	0x00									2
Position		0x00										1
Check Sum		0x09										1
Command		0x54	0x00									2
Data Type		0x14	0x00									2
Reserved		0x00	0x00									2
Block No.		0x01	0x00									2
Variable Length		0x04	0x00									2
Data Address	ASCII	%	M	B	0							4
	HEX	0x25	0x4D	0x42	0x30							
Data Count	HEX	0x02	0x00									2

[Table 1.5.9] Frame for reading variables sequentially

(4) Response frame for reading variables sequentially

Items	Type	Frame										Size
Company ID	ASCII	L	S	I	S	-	X	G	T	/n	/n	10
	HEX	0x4C	0x53	0x49	0x53	0x2D	0x58	0x47	0x54	0x00	0x00	
	ASCII	L	G	I	S	-	G	L	O	F	A	
	HEX	0x4C	0x47	0x49	0x53	0x2D	0x47	0x4C	0x4F	0x46	0x41	
PLC Info	HEX	0x02	0x08									2
CPU Info		0xA0										1
Source of Frame		0x11										1
Invoked ID		0x00	0x01									2
Length		0x0E	0x00									2
Position		0x01										1
Check Sum		0x25										1
Command		0x55	0x00									2
Data Type		0x14	0x00									2
Reserved		0x00	0x00									2
Error State		0x00	0x00									2
Block No.		0x10	0x00									2
Data Count		0x02	0x00									2
Data		0x00	0x00									2

[Table 1.5.10] Response frame for reading variables sequentially

1.5.2 Modbus TCP/IP protocol

The Modbus TCP/IP protocol is the function to Read/Write data by using the function codes. The Modbus TCP/IP frame is composed of MAC for Ethernet communication, IP header, TCP header, Modbus ADU.

- 1) ADU: Application Data Unit
- 2) MBAP: Modbus Application Protocol
- 3) PDU: Protocol Data Unit

1) Frame structure of Modbus TCP/IP

(1) Modbus TCP/IP's frame structure through Ethernet

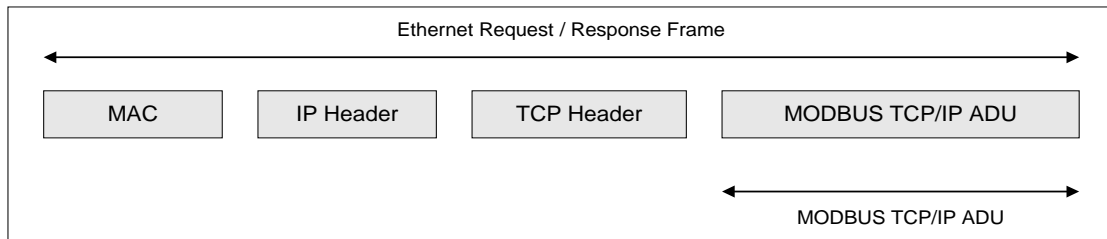

[Table 1.5.1] Modbus TCP/IP's frame structure through Ethernet

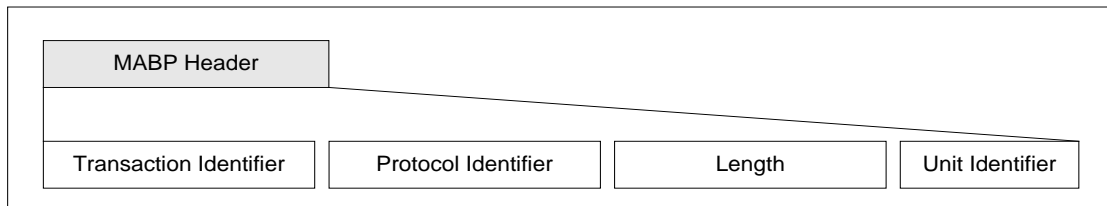

[Table 1.5.2] Modbus MABP structure

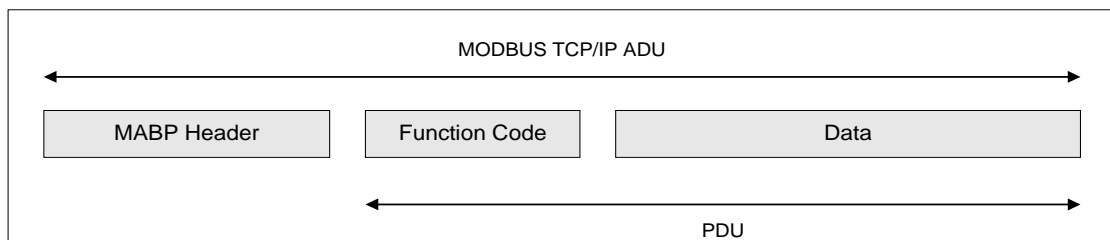

[Table 1.5.3] Modbus ADU structure

(2) MBAP Header structure

Type	Size	Description	Client	Server
Transaction Identifier	2byte	Separation of MODBUS request/response processing	Initialized by the client	When the server responds, it is copied and responded.
Protocol Identifier	2byte	0 = MODBUS protocol	Initialized by the client	When the server responds, it is copied from the request frame.
	2byte	Frame size except MBAP	Created by the client (On request)	Created by the server (In case of response)
Unit Identifier	1byte	Separation of units connected to the serial line	Initialized by the client	When the server responds, it is copied from the request frame

(3) Available function codes

Function codes	Function	Modbus transcription
Function Code 01 (h01)	Reading output bit	Read Coils
Function Code 02 (h02)	Reading input bit	Read Discrete Inputs
Function Code 03 (h03)	Reading output word	Read Holding Registers
Function Code 04 (h04)	Reading input word	Write Input Register
Function Code 05 (h05)	Writing output bit	Write single Coil
Function Code 06 (h06)	Writing output word	Write single Register
Function Code 15 (h0F)	Writing output bit sequentially	Write Multiple Coils
Function Code 16 (h10)	Writing output word sequentially	Write Multiple Registers

2) Frame structures by function codes

(1) Function code h01 : Reading output bit (Read Coils)

• Request

Items	Size	Range
Function code	1 byte	h01
Initial address	2 bytes	h0000 ~ hFFFF
Number of coils	2 bytes	h0001 ~ h07D0 (2000 bit)

• Response

Items	Size	Range
Function code	1 byte	h01
Number of bytes	2 bytes	N
Coil status	n byte	n = N or N + 1

• Error

Items	Size	Range
Function code	1 byte	h81 (function code+ h80)
Exceptional code	1 byte	h01,h02,h03,h04

• Example of Application

Request frame		Response frame	
Items	HEX	Items	HEX
Function code	h01	Function code	h01
Initial address (upper byte)	h00	Number of bytes	h03
Initial address (lower byte)	h13	Coil status (27-20)	hCD
Number of coils (upper byte)	h00	Coil status (36-28)	h6B
Number of coils (lower byte)	h13	Coil status (38-36)	h05

(2) Function code h02 : Reading input bit (Read Discrete Inputs)

• Request

Items	Size	Range
Function code	1 byte	h02
Initial address	2 bytes	h0000 ~ hFFFF
Number of inputs	2 bytes	h0001 ~ h07D0 (2000 bit)

• Response

Items	Size	Range
Function code	1 byte	h01
Number of bytes	2 bytes	N
Input status	N x 1 byte	-

• Error

Items	Size	Range
Function code	1 byte	h82 (Function code + h80)
Exceptional code	1 byte	h01,h02,h03,h04

• Example of application

Request frame		Response frame	
Items	HEX	Items	HEX
Function code	h02	Function code	h02
Initial address (upper byte)	h00	Initial address (upper byte)	h00
Initial address (lower byte)	hC4	Initial address (lower byte)	hC4
Input status (upper byte)	h00	Input status (upper byte)	h00
Number of coils (lower byte)	h16	Number of coils (lower byte)	h16

(3) Function code h03 : Reading output word (Read Holding Registers)

• Request

Items	Size	Range
Function code	1 byte	h03
Initial address	2 bytes	h0000 ~ hFFFF
Number of inputs	2 bytes	h0001 ~ h007D (125word)

• Response

Items	Size	Range
Function code	1 byte	h01
Number of bytes	2 bytes	2 x N
Input status	N x 2 bytes	-

• Error

Items	Size	Range
Function code	1 byte	h83 (Function code + h80)
Exceptional code	1 byte	h01,h02,h03,h04

• Example of application

Request frame		Response frame	
Items	HEX	Items	HEX
Function code	h03	Function code	h03
Initial address (upper byte)	h00	Number of bytes	h06
Initial address (lower byte)	h6B	Word status (108)	h02
Number of words (upper byte)	h00	Word status (108)	h2B
Number of words (lower byte)	h03	Word status (109)	h00
		Word status (109)	h00
		Word status (110)	h00
		Word status (110)	h64

(4) Function code h04 : Writing input word (Read Input Registers)

• Request

Items	Size	Range
Function code	1 byte	h04
Initial address	2 bytes	h0000 ~ hFFFF
Number of inputs	2 bytes	h0001 ~ h007D (125word)

• Response

Items	Size	Range
Function code	1 byte	h04
Number of bytes	2 bytes	2 x N
Input status	N x 2 bytes	-

• Error

Items	Size	Range
Function code	1 byte	h84 (Function code + h80)
Exceptional code	1 byte	h01,h02,h03,h04

• Example of application

Request frame		Response frame	
Items	HEX	Items	HEX
Function code	h04	Function code	h04
Initial address (upper byte)	h00	Number of bytes	h02
Initial address (lower byte)	h08	Word status (108)	h00
Number of words (upper byte)	h00	Word status (108)	h0A
Number of words (lower byte)	h01		

(5) Function code h05 : Writing output bit (Write Single Coil)

• Request

Items	Size	Range
Function code	1 byte	h05
Initial address	2 bytes	h0000 ~ hFFFF
Input value	2 bytes	h0000 or hFF0D

• Response

Items	Size	Range
Function code	1 byte	h05
Number of bytes	2 bytes	h0000 ~ hFFFF
Input status	2 bytes	h0000 or hFF00

• Error

Items	Size	Range
Function code	1 byte	h85 (function code+h80)
Exceptional code	1 byte	h01,h02,h03,h04

• Example of application

Request frame		Response frame	
Items	HEX	Items	HEX
Function code	h02	Function code	h01
Initial address (upper byte)	h00	Number of bytes	h03
Initial address (lower byte)	hC4	Coil status (27-20)	hCD
Input status (upper byte)	h00	Coil status (36-28)	h6B
Number of coils (lower byte)	h16	Coil status (38-36)	h05

(6) Function code h 0F : Writing output word sequentially (Write Multiple Registers)

• Request

Items	Size	Range
Function code	1 byte	h0F
Initial address	2 bytes	h0000 ~ hFFFF
Number of outputs	2 bytes	h0001 ~ h07BD
Number of bytes	1 byte	N
Output value	N x 1 byte	

• Response

Items	Size	Range
Function code	1 byte	h0F
Number of bytes	2 bytes	h0000 ~ hFFFF
Input status	2 bytes	h0001 ~ h07B0

• Error

Items	Size	Range
Function code	1 byte	h8F (function code+ h80)
Exceptional code	1 byte	h01,h02,h03,h04

• Example of application

Request frame		Response frame	
Items	HEX	Items	HEX
Function code	h0F	Function code	h0F
Initial address(upper byte)	h00	Initial address (upper byte)	h00
Initial address(lower byte)	h13	Initial address (lower byte)	h13
Number of outputs (upper byte)	h00	Number of outputs (upper byte)	h00
Number of outputs (lower byte)	h0A	Number of outputs (lower byte)	h0A
Number of bytes	h02		
Output value (upper byte)	hCD		
Output value (lower byte)	h01		

(7) function code h06 : output word (Write Single Register)

• Request

Items	Size	Range
Function code	1 byte	h06
Initial address	2 bytes	h0000 ~ hFFFF
Output value	2 bytes	h0000 or hFFFF

• Response

Items	Size	Range
Function code	1 byte	h06
Initial address	2 bytes	h0000 ~ hFFFF
Output value	2 bytes	h0000 or hFFFF

• Error

Items	Size	Range
Function code	1 byte	h86 (function code+ h80)
Exceptional code	1 byte	h01,h02,h03,h04

• Example of application

Request frame		Response frame	
Items	HEX	Items	HEX
Function code	h06	Function code	h06
Initial address (upper byte)	h00	Number of bytes	h00
Initial address (lower byte)	h01	Coil status (27-20)	h01
Input status (upper byte)	h00	Coil status (36-28)	h00
Number of coils (lower byte)	h03	Coil status (38-36)	h03

(8) Function code h10 : Writing output sequentially (Write Multiple Registers)

• Request

Items	Size	Range
Function code	1 byte	h10
Initial address	2 bytes	h0000 ~ hFFFF
Number of outputs	2 bytes	h0001 or h07D8
Number of bytes	1 byte	2 x N
Output value	N x 2 bytes	value

• Response

Items	Size	Range
Function code	1 byte	h10
Number of bytes	2 bytes	h0000 ~ hFFFF
Number of outputs	2 bytes	h0001 ~ h007B

• Error

Items	Size	Range
Function code	1 byte	h90 (function code+ h80)
Exceptional code	1 byte	h01,h02,h03,h04

• Example of application

Request frame		Response frame	
Items	HEX	Items	HEX
Function code	h10	Function code	h01
Initial address (upper byte)	h00	Initial address (upper byte)	h00
Initial address (lower byte)	h01	Initial address (lower byte)	h01
Number of outputs (upper byte)	h00	Number of outputs (upper byte)	h00
Number of outputs (lower byte)	h02	Number of outputs (lower byte)	h02
Number of bytes	h04		
Output value(upper byte)	h00		
Output value(lower byte)	h0A		
Output value(upper byte)	h01		
Output value(lower byte)	h02		

1.5.3 File Transfer Protocol (FTP)

The File Transfer Protocol is the TCP/IP-based dedicated protocol for file transfer. FTP is the function to read, write, delete, edit, move, search files saved to various file systems of the FTP server through FTP commands. The File Transfer Protocol is the TCP/IP-based one so it is composed of MAC header, IP header, TCP header, FTP message.

- Frame structure of FTP

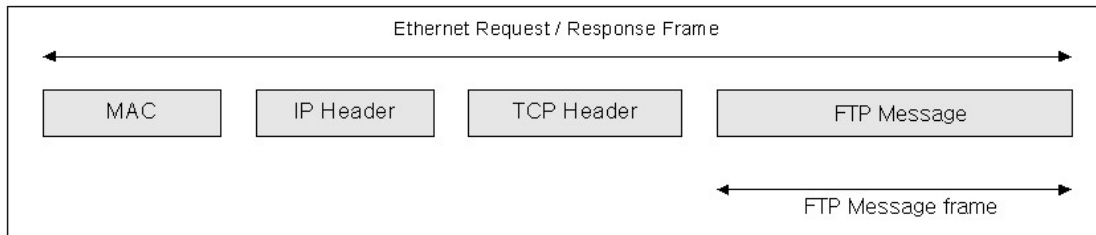

1.6 Dedicated services

1.6.1 Outline

1) Server model

The dedicated services mean the server functions in the below client/server model of [Fig. 1.6.1]. It Reads/Writes data based on the protocols assessed and set by the client.

(1) Client/server model

The server performs the functions; ② detection of reception ③ transmission of response.

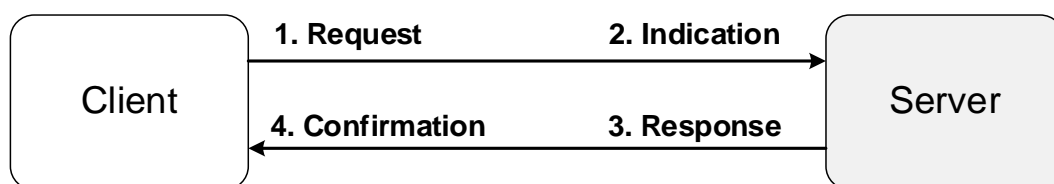

[Fig.1.6.1] Server/client model

(2) System configuration

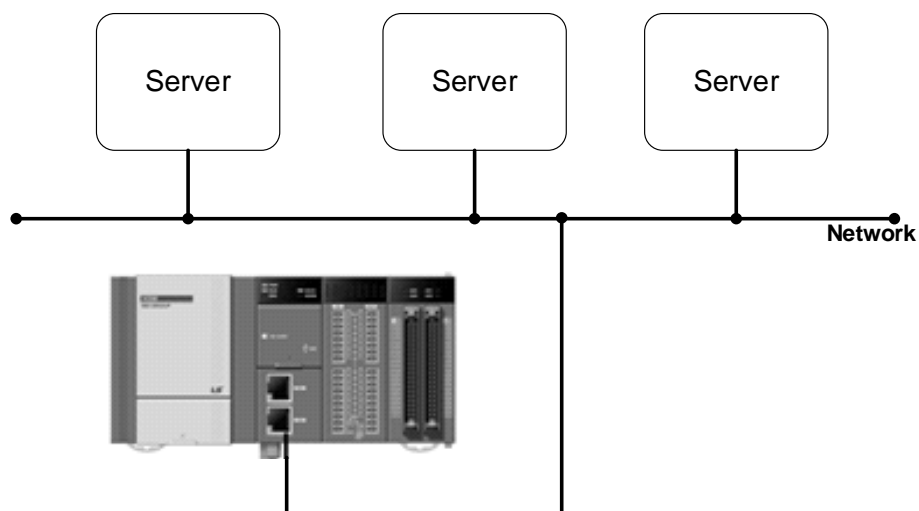

(3) Classification of dedicated services

Dedicated services		Port No.	Protocol	Max./Min. number of accesses
XGT server	TCP XGT server	2004	TCP	1/16
	UDP XGT server	2005	UDP	1/16
Modbus TCP/IP server		502	TCP	1/16

1.6.2 Setting the basic parameters

- 1) Confirming registration of built-in communication
- (1) Setting the basic parameters for XG5000 communication

If you create a project after executing XG5000, only the basic network will be displayed in the network configuration. After accessing to the PLC, if you execute I/O synchronization in [Online] → [Diagnosis] → [I/O information], the built-in communication modules will be updated. Then, if you choose the built-in FEnet, the window for setting communication modules will be executed. The built-in FEnet is automatically set so you cannot change the type, base, slot.

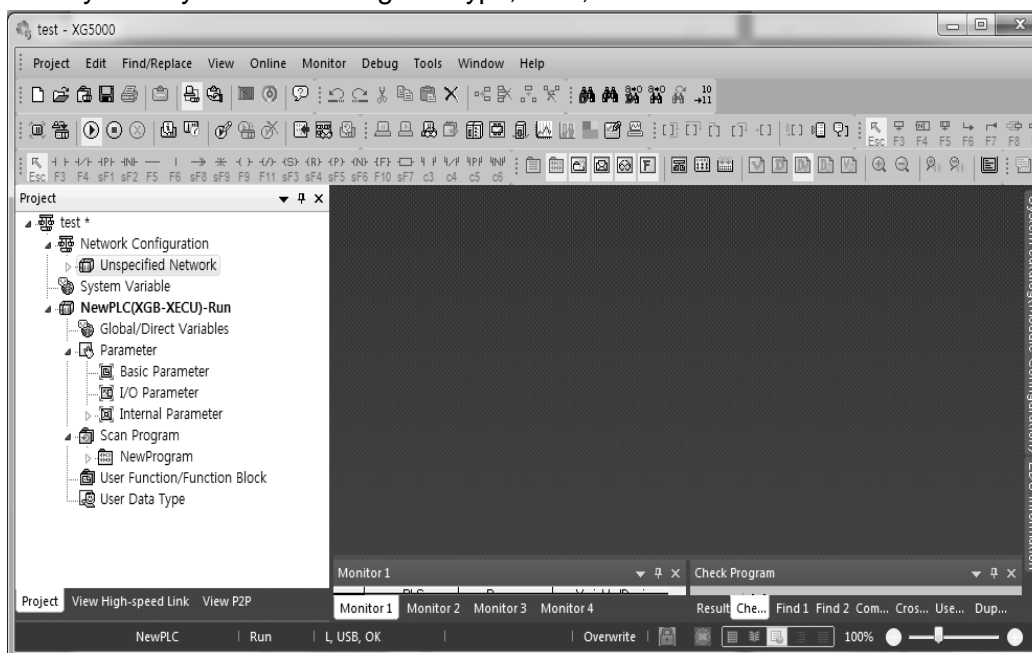

[Fig. 1.6.2] Creation of new project in XG5000

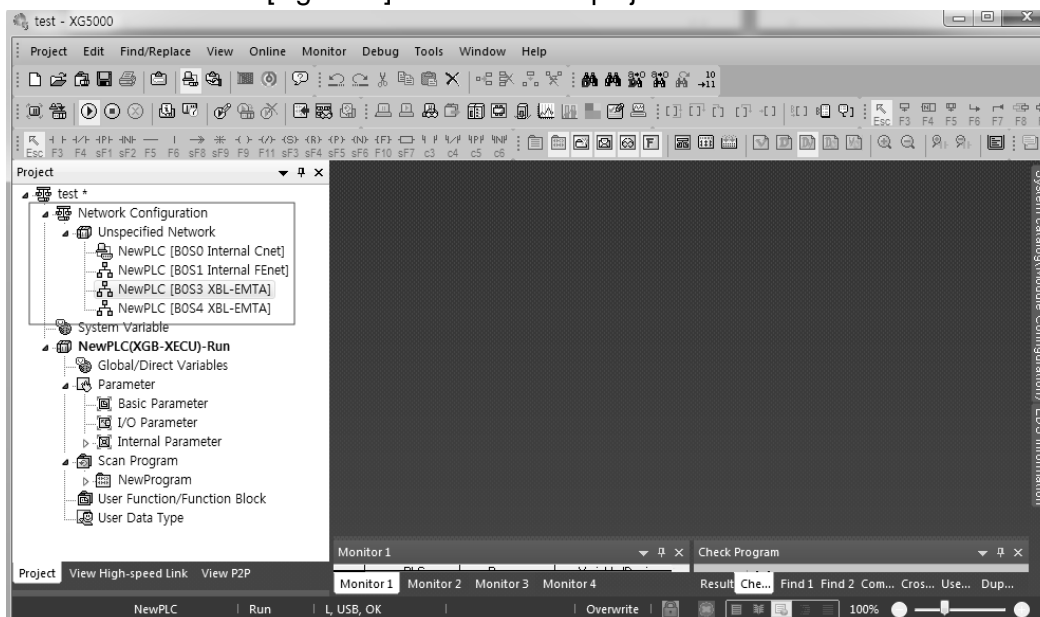

[Fig. 1.6.3] Changes of the network configuration after I/O synchronization

(2) Basic setting

If you double-click the FENet, the window for the basic setting will be created as below [Fig. 1.6.4].

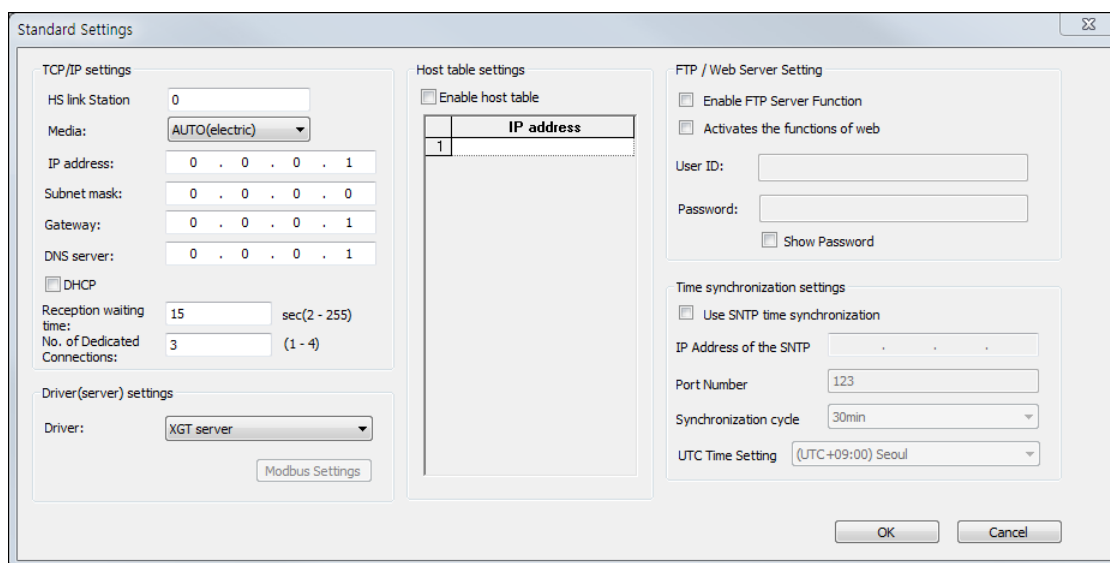

[Fig.1.6.4] Window for the basic settings of communication

The descriptions on each item are as below.

a) TCP/IP setting

Item	Description
High speed link exchange number	For high speed link communication between XGT PLC's FENet I/F modules, the FENet I/F module to set exchange number should not overlapped with the exchange numbers of other FENet I/F modules that are accessible in the network.
Media	Select the media to be used. ▷ AUTO (electricity): It sets the media of the currently equipped module automatically. ▷ 10M/HALF: Half Duplex electricity of 10Mbps ▷ 10M/FULL: Full Duplex electricity of 10Mbps ▷ 100M/HALF: Half Duplex electricity of 100Mbps ▷ 100M/FULL: Full Duplex electricity of 10Mbps
IP address	You can set the IP address of the FENet I/F module.
Subnet Mask	Value to determine whether the opposing station exists in the same network as its own.
Gateway	Gateway module address (router address) to transmit and receive data through the station using different network from its own or public network.
DNS server	You can designate domain name server.
DHCP	For using the flexible IP instead of the static IP.
Reception standby time (second)	During dedicated communication, if there is not any RUN request for the set time from the upper system on condition that it is assessed to the upper PC or MMI, the connection with the dedicated service will end regardless of normal termination on the assumption that there are some problems with the upper system. The standby time is used for dedicated services to reset the channels when there are some errors in the opposing station or cables are disconnected.
Number of dedicated	It means the maximum number of TCP dedicated services that are

accesses	assessable at the same time. Setting of 1~16 is available. (In the case of P2P channel, the number of 16-dedicated accesses)
----------	---

b) Driver (server) setting

Item	Description
XGT server	For operation with the dedicated communication server
Modbus TCP/IP server	For operation with the Modbus server driver
Smart server	Simultaneous support of XGT server and Modbus server (only available in V1.7 or later)

c) Host table setting

Item	Description
Enable host table	In case of Enable host table, it allows assess for the client who has the IP address registered to the host table.

d) FTP / web server setting

Item	Description
Activation of FTP server function	Setting the FTP server's operations
Activation of web server function	Setting the web server's operations
User ID	ID required to connect to the PLC from the web server/FTP client
Password	Setting the password of the user ID(used for web server/FTP commonly)
Show password	For a user to check the set password

e) Setting the time synchronization function

Item	Description
SNTP time synchronization function	Setting SNTP time synchronization operations
IP Address of the SNTP	SNTP server's IP address
Port Number	SNTP server's port No.
Synchronization cycle	Time synchronization cycle between the SNTP server and the PLC
UTC Time setting	Setting SNTP time according to UTC(Universal Time Coordinated)

1.6.3 XGT server

The TCP XGT server works in sequence as shown in the operating sequence of the below [Fig. 1.6.5].

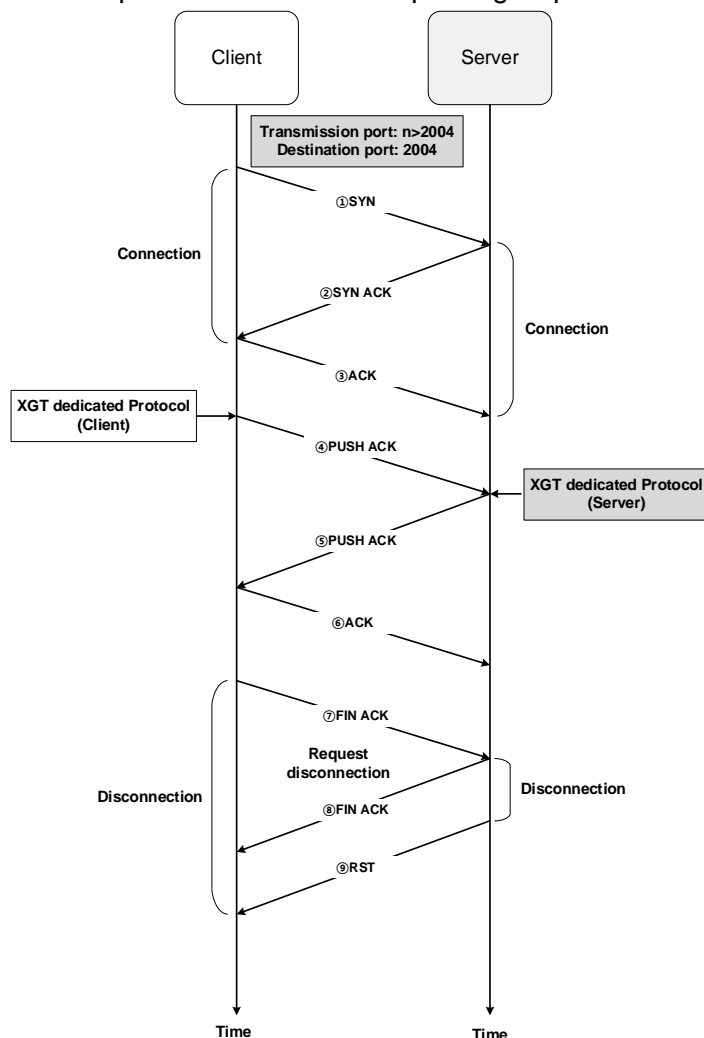

[Fig.1.6.5] Operating sequence of the TCP XGT server

1) Connection

The client sends the ① connection request to the server and then, the server transmits the ② response to connection request. The connection port number is Port No. 2004 of the XGT dedicated protocols.

Then, the client sends the ③ response to confirmation of connection. After the stages of ①~ ③ are completed, connection between client/server is made.

2) TCP XGT server

After connection, the client transmits the ④ request frame based on the XGT dedicated protocols.

Then, the server transmits the ⑤ response to the request frame and the client transmits the ⑥ confirmation of response.

3) Disconnection

The client transmits ⑦ disconnection request and the server transmits ⑧ confirmation of disconnection and ⑨ terminates the connection.

1.6.4 Modbus TCP/IP server

The Modbus TCP/IP server works in sequence as shown in the operating sequence of the below [Fig. 1.6.6].

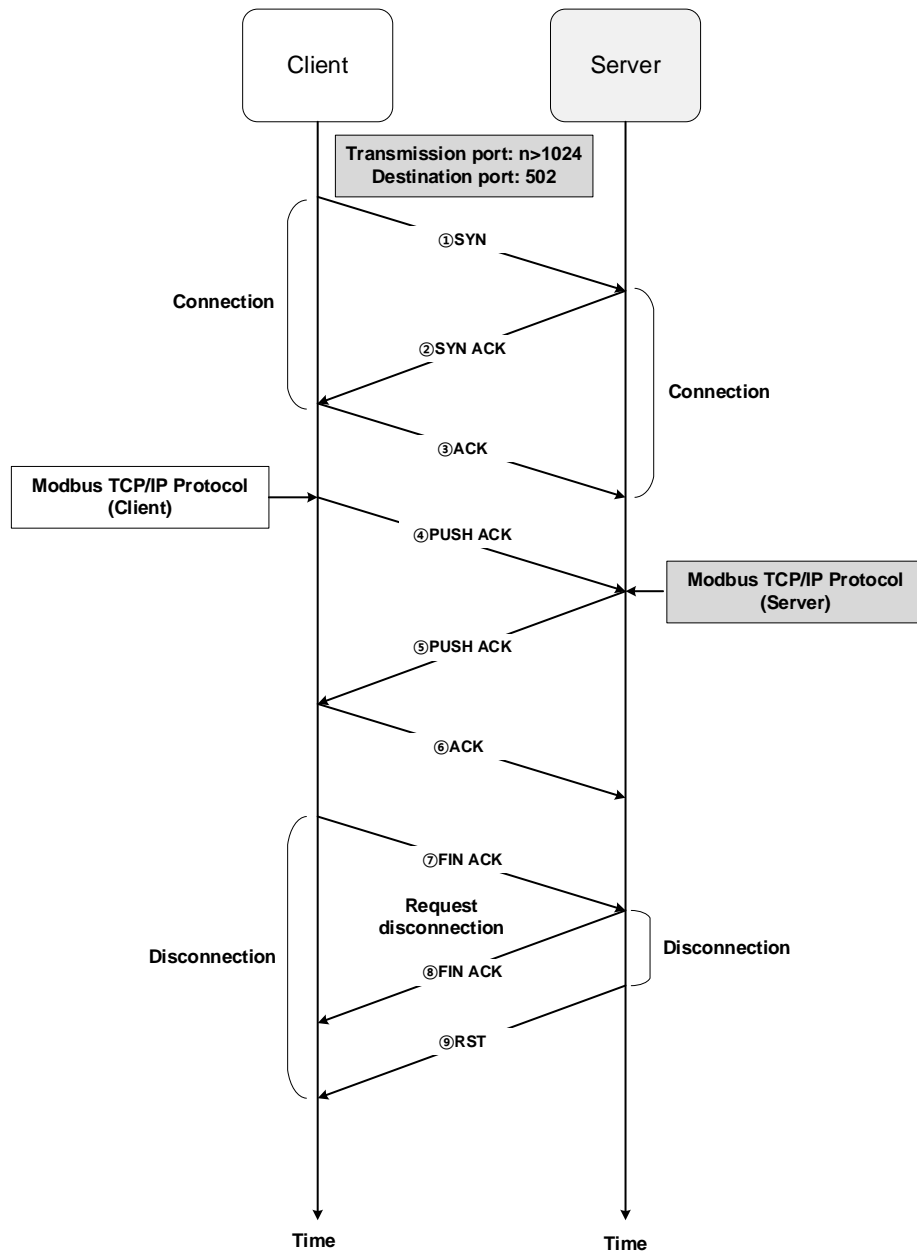

[Fig.1.6.6] Operating sequence of the Modbus TCP/IP server

1.7 P2P service

1.7.1 Outline

The P2P service means the client function in the below client/server model of [Fig. 1.7.1].

It is the function to request Read/Write Data to the server. If the startup conditions of each block are On, it creates the request frames and receives responses for processing with the protocols that are designated as the relevant channel.

XGB's built-in FEnet can realize the function through up to 7 channels and you can use other protocols for each channel.

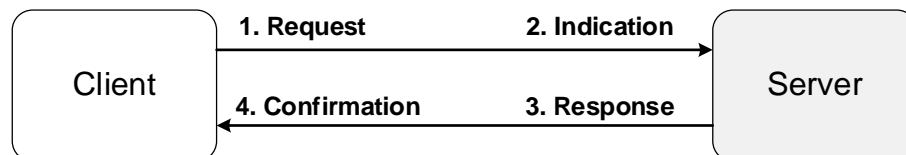

[Fig. 1.7.1] Server/client model

The Client performs the functions of ① transmission of request ④ confirmation.

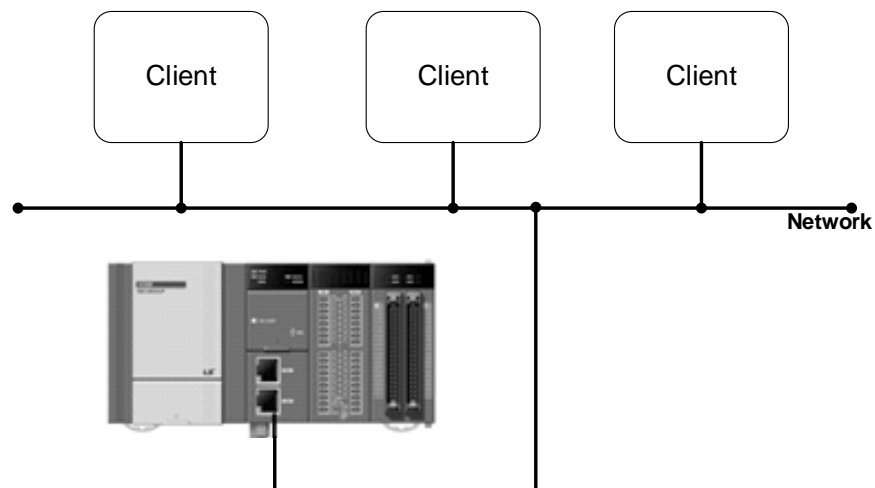

[Fig. 1.7.2] Server/client configuration

1.7.2 Setting P2P parameters

[Fig. 1.7.3] shows the example of setting P2P parameters of XG5000.

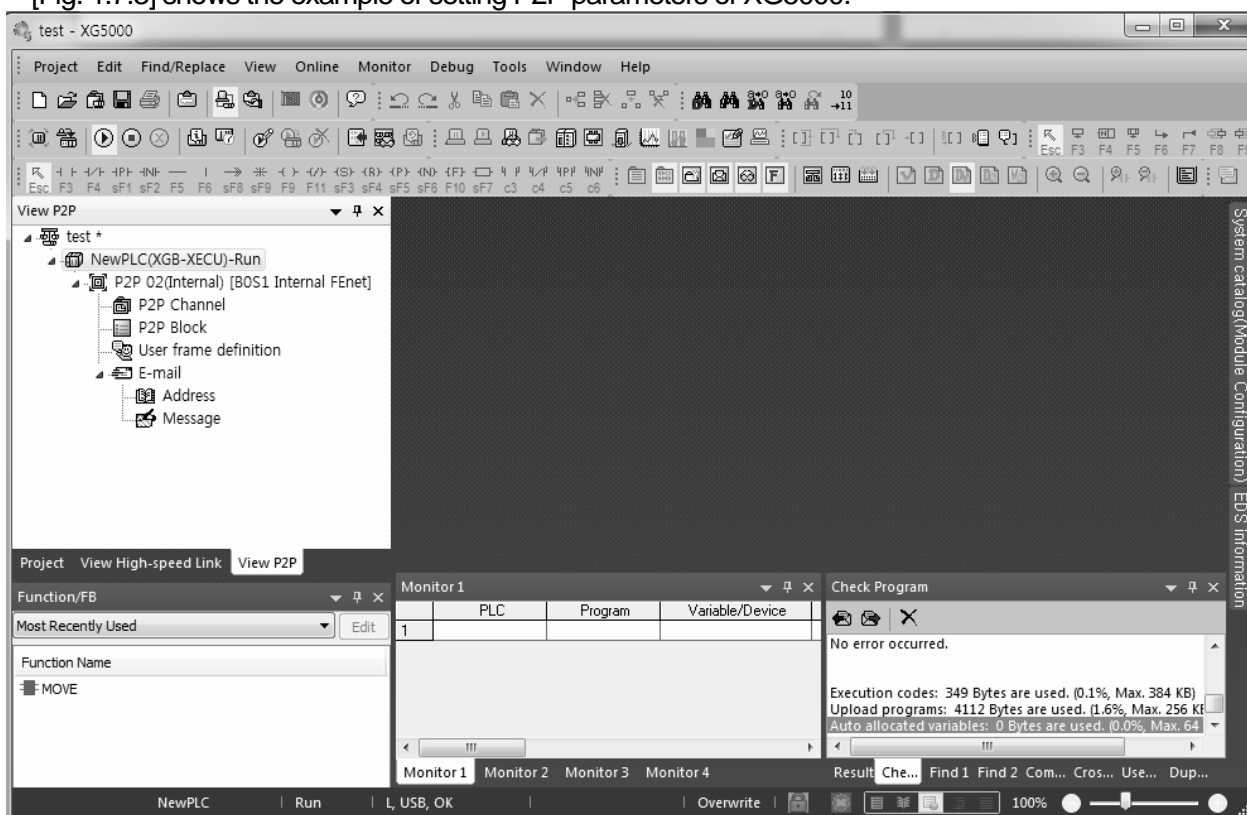

[Fig. 1.7.3] Window for P2P setting of XG5000

- Window for registering P2P parameters
 - You can set the P2P parameters up to 6.
 - Each P2P is composed of P2P channel, P2P block, user-defined frame, E-mail.
- Window for editing P2P
 - You can register and edit P2P block up to 32.
 - You can separately register frames by driver.

1) Setting FEnet communication

You need to set P2P parameters to use P2P services.

- (1) Click the PLC module with the right mouse button on the P2P tab and choose P2P communication.

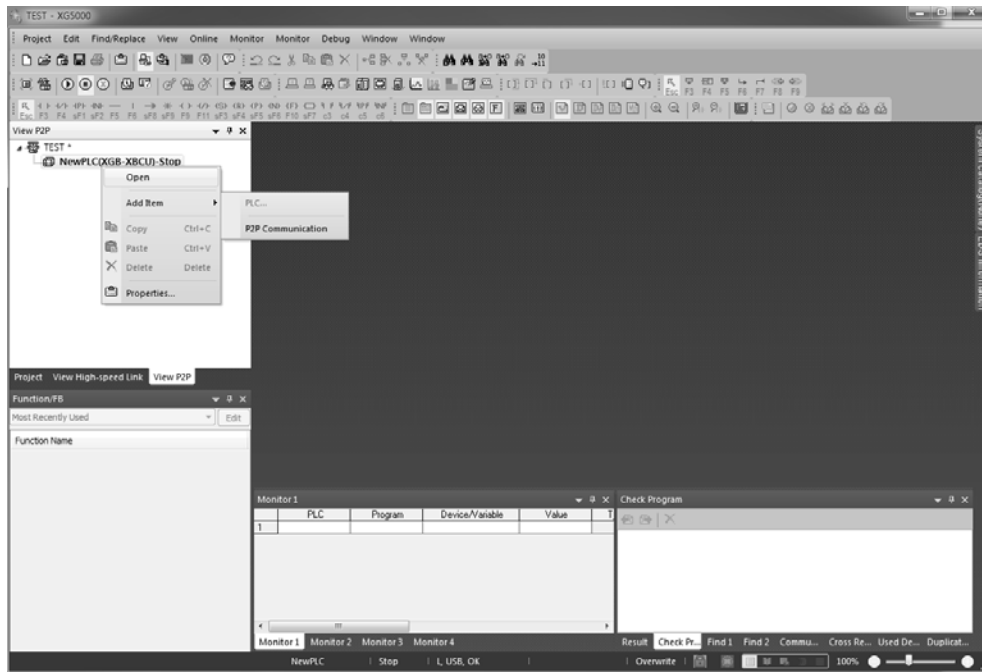

- (2) Choose the P2P number to create the P2P module to be used.

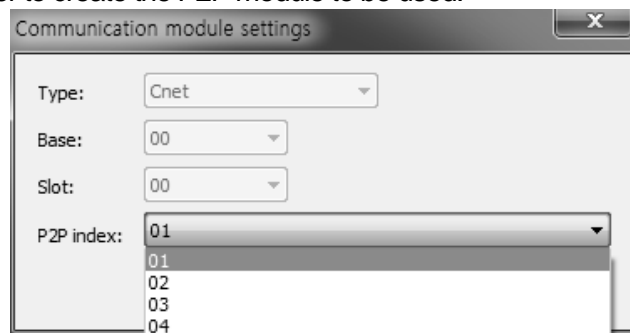

- (3) P2P 01 that XGB basic unit's built-in communication setting is fixed as Cnet.
- (4) P2P 02 that XGB basic unit's built-in communication setting is fixed as FEnet.

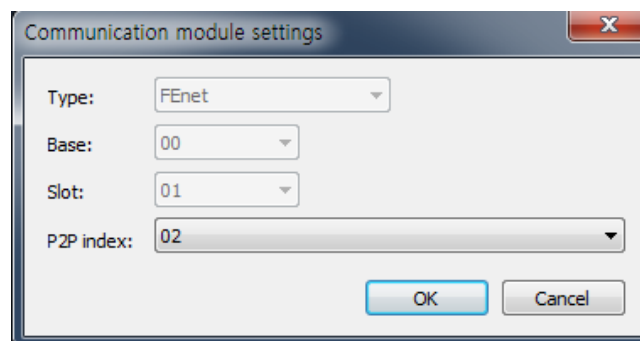

- (5) Double-click to confirm the communication settings.
- (6) The base is fixed as 0.
- (7) The slot is automatically designated as slot 2 that has the built-in FEnet.
- (8) If communication settings are completed, click the 'OK' button.
- (9) If you click the 'OK' button, the detailed items of P2P will be created in the project window as the figure of the next page.

2) Configuration of P2P parameters

If you set the communication modules in the P2p screen, the window for setting P2P parameters will be displayed as the below figure. P2P is composed of 4 data.

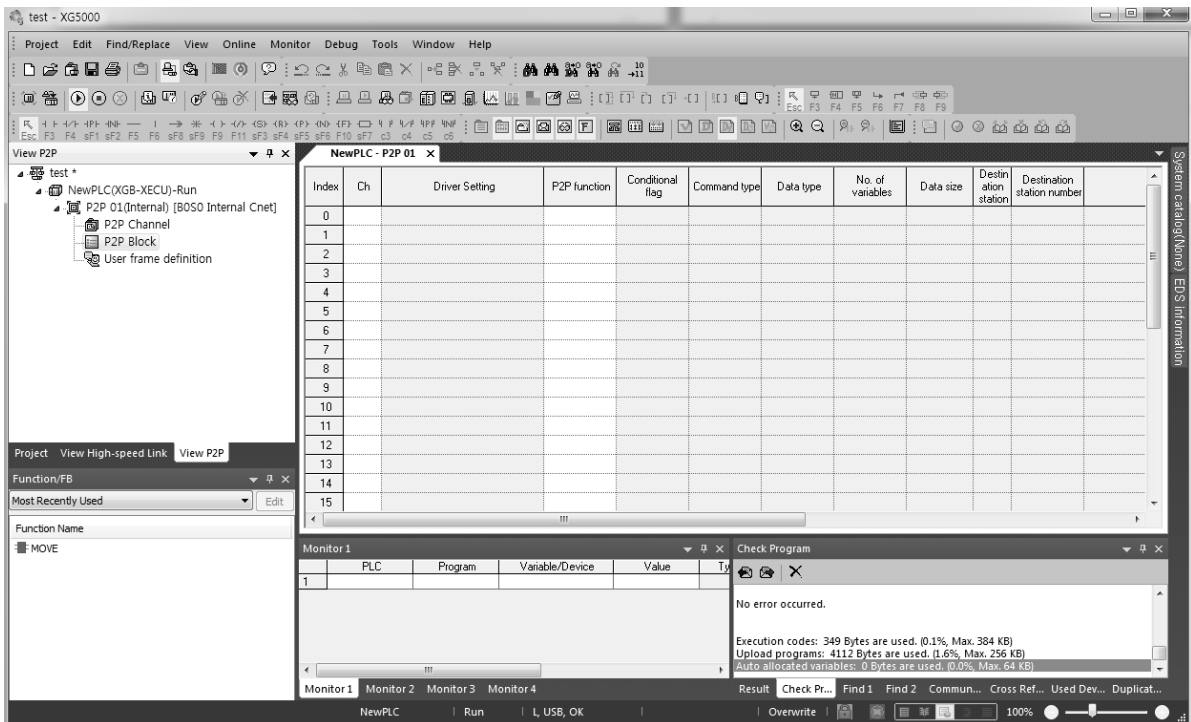
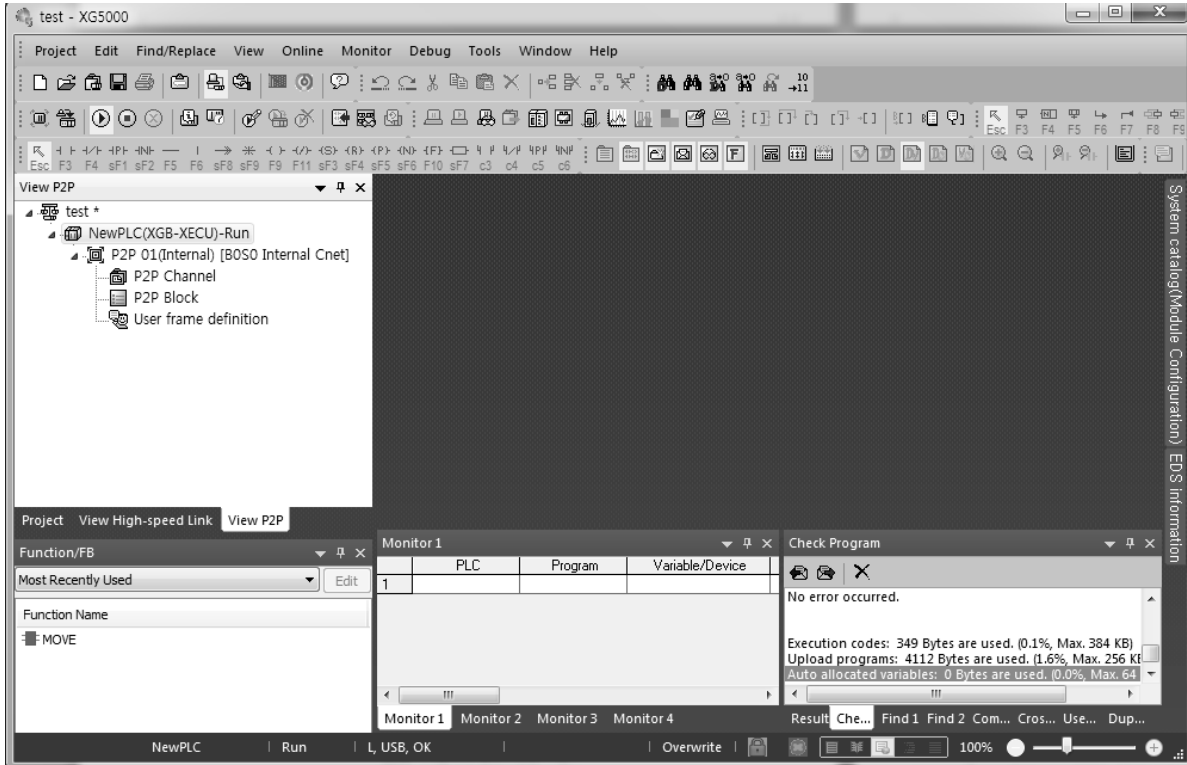

- (1) P2P channel
 - Setting logical channels (IP, PORT, dedicated driver) of P2P services.
 - Setting user-defined frame, XGT client, MODBUS TCP client
 - Setting communication equipments using the protocols other than XGT/MODBUS TCP.
- (2) P2P block
 - Setting 32 P2P blocks that are operated independently.
- (3) User-defined frames
 - Registration of user-defined frames
- (4) E-mail
 - Registration of frames to transmit and receive E-mail frames

1.7.3 Kinds of P2P services

1) Kinds of P2P commands

The P2P that a user applies for programming can be divided into 6 commands.

The commands should be different depending on the service types so refer to the below table for proper application.

Items	Commands	Purposes
XGT client	Read	Reads the designated area of the opposing station.
	Write	Transmits its own station's area data to the opposing station.
User-defined frame	Send	Sends its own station's area data to the opposing station.
	Receive	Receives the transferred data from the opposing station and saves it.
Modbus TCP	Read	Reads the designated area of the opposing station.
	Write	Transmits its own station's area data to the opposing station.
E-mail	ESend	Transmits the message in case of occurrence of events.

2) Kinds of P2P services

(1) XGT client

The XGT client service is used to define transmission and reception of data of XGB's built-in FEnet. For simple communication, a user only needs to designate the basic settings such as channels and data type (BIT,BYTE,WORD, etc.) and memory areas, etc. No. 2004 port is used for TCP and No. 2005 port is used for UDP.

(2) User-defined frame

It is the service that makes a user define other companies' protocols in XGB FEnet for communication between XGB's built-in FEnet and other XGT's FEnet I/F modules or communication with other models. The communication protocols may be different depending on the manufacturers. Through the function of user-defined frame, a user can apply and edit the frames according to the characteristics of the relevant communication modules. The basic structure of user-defined frame is composed of HEAD, BODY, TAIL.

(3) Modbus TCP

XGB FEnet supports the Modbus protocol that is the industrial standards. The Port No. is fixed as 502.

1.7.4 How to set up P2P services

1) Ethernet Driver

(1) Driver setting

The Ethernet Driver means the protocols that will work when the built-in FEnet is operated by the server. There are the XGT server and Modbus TCP/IP server for the built-in protocols. You can set the Ethernet Driver based on the protocols to be used when the opposing station reads the basic unit's data through the built-in FEnet or writes the data to the basic unit. In the majority of cases, the communication opposing station is usually MMI (or HMI). In this case, a user can communicate with the opposing devices by setting parameters without separate communication programming. The below figure shows the typical example of using the Ethernet Driver; communication with MMI PC. When the MMI PC requests the data, FEnet will respond.

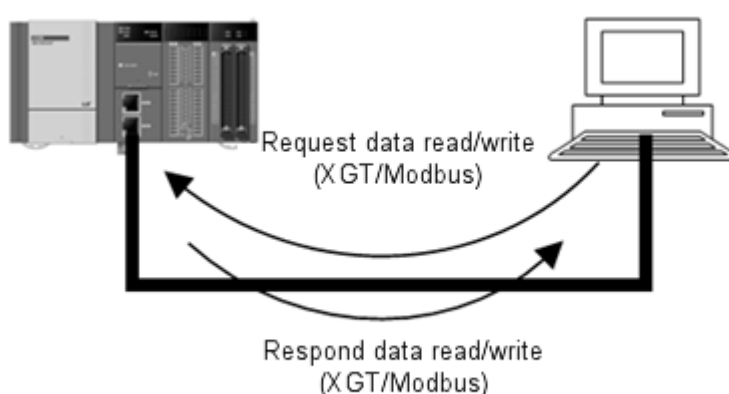

• Types of Ethernet (server) Drivers

The available driver types are as below.

Types	Descriptions
XGT server	LS ELECTRIC's XGT FEnet dedicated protocol
Modbus TCP/IP server	Modicon's open protocol

Notice

- (1) The number of drivers varies depending on the set Ethernet channels and if you set the Ethernet channels, the number of available drivers will be as small as the number of set channels. Accordingly, be careful of this.
- (2) The Ethernet (server) Driver can realize 1:N communication so several client devices can connect the one set port to obtain data.

2) P2P channel

The Ethernet P2P channel is used When the PLC is operated as Master by using XGT FEnet's built-in protocols or when the PLC should communicate through user-defined protocols

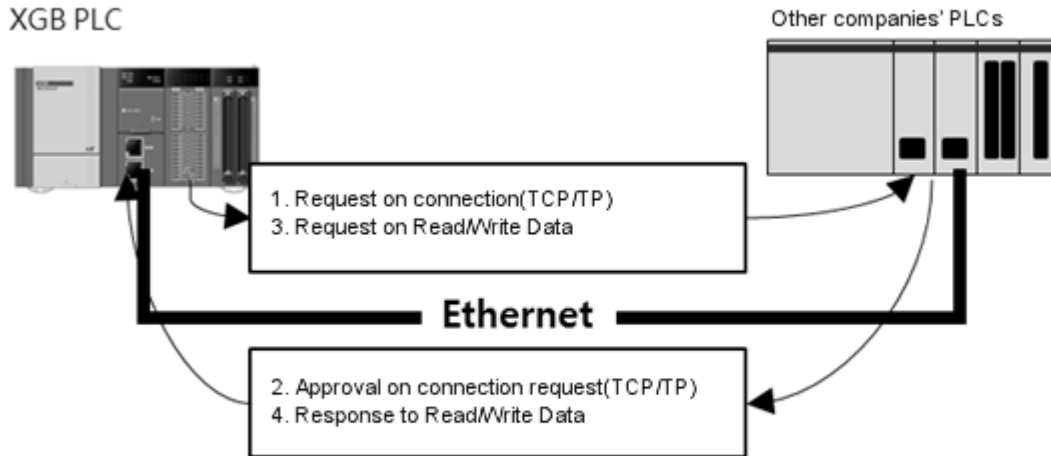

<Example of using P2P channel information>

(1) P2P channel setting

The built-in FEnet can transmit and receive the data by using the maximum of 4 channels and the channel is composed of the IP address and port number of the communication device.

The number of available channels in P2P is the number that subtracts the number of dedicated accesses in the basic parameter from the total number of channels (4). (Number of P2P channels=4–number of dedicated accesses)

For user convenience, P2P allows the communication with the devices using XGT, Modbus TCP protocols by setting simple parameters. For communication with other devices, it provides the function of user-defined frames. In addition, a user can register the message and mail address to transmit and receive the E-mail frame. (It supports ASCII)

However, you do not need to set the channels for E-mail communication. If you choose the P2P channel in the window for P2P setting, the below window will pop up.

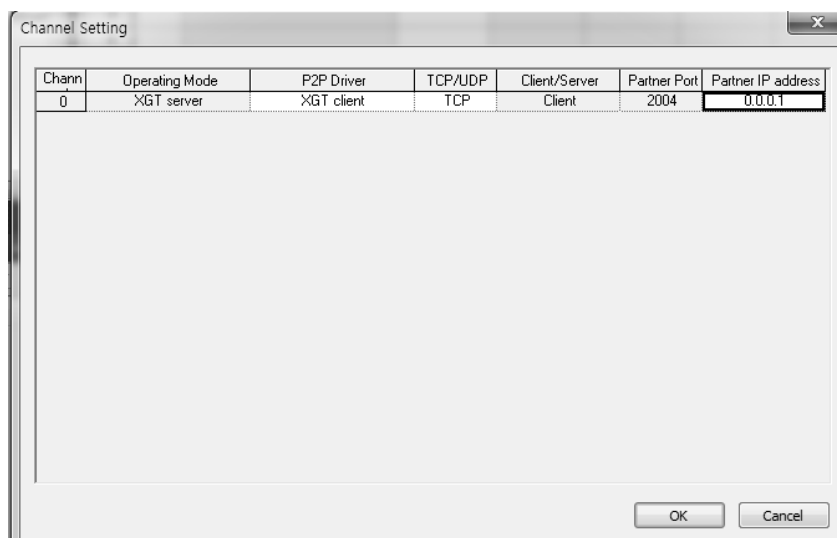

You can define the P2P driver type by selecting the 'P2P Driver' of the desired channel.

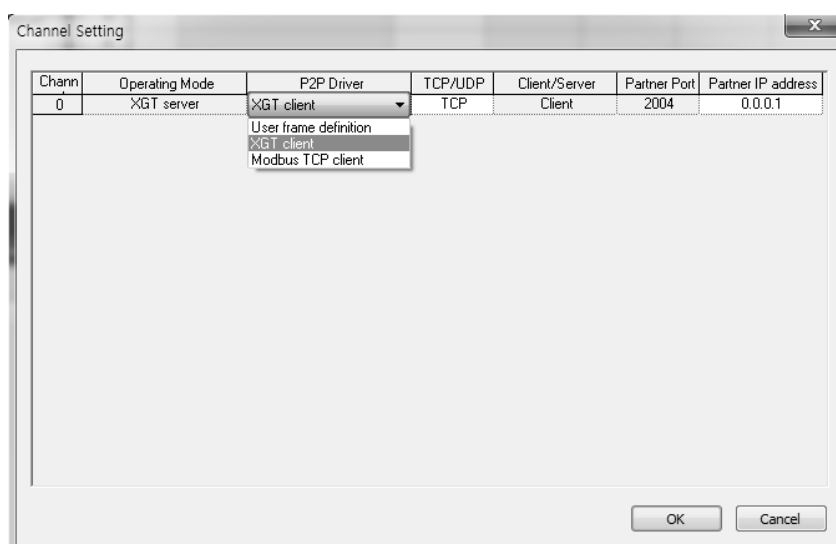

<Selection of P2P Driver client >

The below table shows the available driver types for the built-in FEnet interface and the descriptions

Items		Descriptions
P2P Driver	User defined frame	It is the protocol defined by a user for communication with the opposing device.
	XGT client	XGT dedicated protocol. (No user-defined frame)
	Modbus TCP client	Defines the operations with MODICON's Modbus TCP protocols.
TCP/UDP		You can select between the TCP/UDP. If you select the Modbus TCP, it will be fixed as TCP.
Client/Server		You can select between the Client/Server. If you select the XGT dedicated protocol OR Modbus TCP, it will be fixed as Client.
Partner Port		You can input the opposing device's port number. It is the user-defined frame so when defining the protocols, the random port is designated and you can set the ports at the range of 1~65535. However, the XGT dedicated protocol is fixed as 2004 and the TCP is fixed as 502.
Partner IP Address		You can input the opposing device's IP address.

If you choose the XGT client or Modbus TCP client for the P2P Driver, you cannot apply the user-defined frame

Notice

(1) Opposing station's IP address

In case XGT is client, make sure to set the server device's IP address. If the server is dynamically allocated the IP through DHCP, the IP address may be changed so you need to check the IP address before use.

3) How to use the Modbus Driver

The below table shows the commands and addresses of the Modbus devices.

Code	Names of function codes	Modicon PLC's data address	Remarks
01	Read output contact status (Read Coil Status)	0XXXX (bit-output)	Bit Read
02	Read input contact status(Read Input Status)	1XXXX (bit-input)	Bit Read
03	Read output register (Read Holding Registers)	4XXXX (word-output)	Word Read
04	Read input register (Read Input Registers)	3XXXX (word-input)	Word Read
05	Write output contact 1 bit (Force Single Coil)	0XXXX (bit-output)	Bit Write
06	Write output register 1 word (Preset Single Register)	4XXXX (word-output)	Word Write
15	Sequential Write output contact(Force Multiple Coils)	0XXXX (bit-output)	Bit Write
16	Sequential Write output register (Preset Multiple Register)	4XXXX (word-output)	Word Write

(3) P2P block

If you choose the P2P block of the relevant parameter, the window for setting P2P parameters will be displayed.

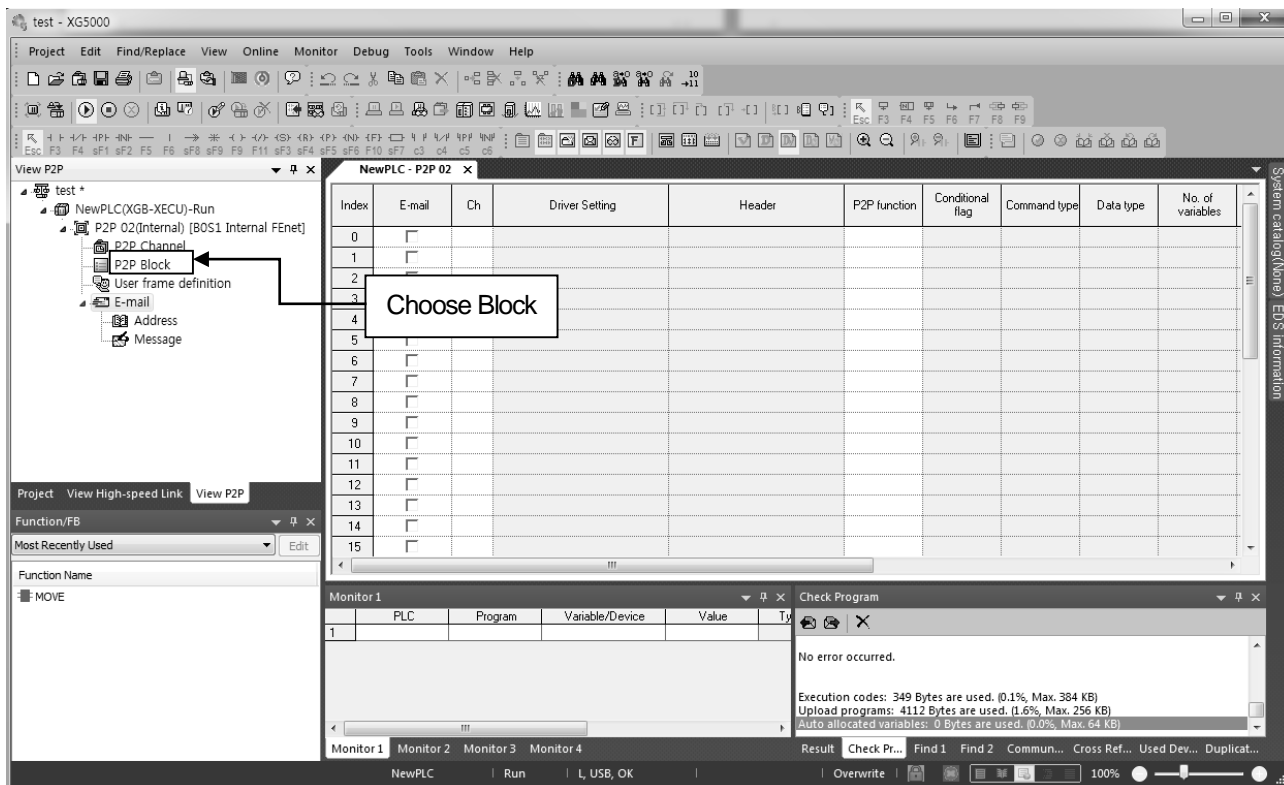

You can set up the independent blocks up to 32. If you choose the random block in XG5000, you can designate the operations of the relevant block by selecting functions as below.

Index	E-mail	Ch	Driver Setting	Header	P2P function	Conditional flag	Command type	Data type
0	<input type="checkbox"/>	0	XGT client	LS-XGT				
1	<input type="checkbox"/>							

The setting items by functions and the descriptions are as below.

(1) E-mail

It is used to set up the E-mail service.

(2) Channel

You can select the communication port to be used for the relevant block. The communication port of each block is determined at the time of setting parameter and it cannot be changed during RUN. The maximum number of configurable channels is the number that subtracts the number of set dedicated accesses from total 16 communication modules 'basic settings' of XG5000.

(3) Driver Setting

It means the communication driver designated by P2P setting. When designating channels, the driver for the relevant channel is automatically loaded. In case of arbitrary deletion of P2P channel setting, the set driver will be deleted. For more details, refer to 1.7.2 P2P channel.

(4) P2P functions

You can choose the P2P functions depending on the set channel drivers. Read/Write data can be performed from the opposing station with the set drivers.

- For the XGT client, choose READ/WRITE.
- For the Modbus TCP client, choose READ/WRITE.
- For the user-defined frame, choose SEND/RECEIVE

a) READ

It is the function to read and save the random area of the opposing station. It can be used for both the XGT client and the Modbus TCP client driver.

b) WRITE

It is the function to write data in the desired area of the opposing station. It can be used for both the XGT client and the Modbus TCP client driver. It supports Sequential Write and Individual Write and it is possible to write data for the maximum of 4 individual areas.

c) Send

It is the function to transmit the random frame to the external device to be accessed through unspecified communication not XGT client/Modbus TCP client protocol. It is applied to the user-defined frame.

You can select and use just one frame per one Frame Send. Through this function, you need to designate the fixed /variable sized variables of the relevant frames. Before using this function, you need to define the frame to be transmitted.

d) Receive

It is the function to receive some frames among the frames that are sent to the opposing station. You cannot choose the same frame for each P2P Frame Receive function block. You can choose just one reception function block for the reception frame.

(5) Conditional flag

It defines when the P2P block works and you can choose fixed cycle and memory set trigger conditions. Startup conditions are the internal contacts of XGB basic unit.

(6) Command Type

You can determine the detailed operations of Read; you can choose between Individual Read and Sequential Read. Individual Read covers the maximum of 4 memory areas (XGT protocol) and Sequential Read covers the defined size at the designated position.

(7) Data type

It defines the data type that will be processed by the blocks. In the case of XGT, it is possible to process data of bit, byte, 2 bytes (1 word), 4 bytes (double word), 8 bytes (long word).

(8) Number of variables

It can be defined only when you choose Individual Read. It determines the number of areas to be read individually and in the case of XGT, you can choose them up to 4. In the case of Modbus, it is fixed as 1.

(9) Data size

It defines the size of the data to be read when you choose Sequential Read and the data size is different depending on the data type.

(10) Frame

You can select the relevant frame (group) setting that will perform communication when defining the user frame.

(11) Setting

You can designate the memory area to be transmitted/received when setting XGT client or user definition. For transmission, as shown in the below figure, designate the area that will save the area (M0000) to be transmitted and the received data from the opposing station.

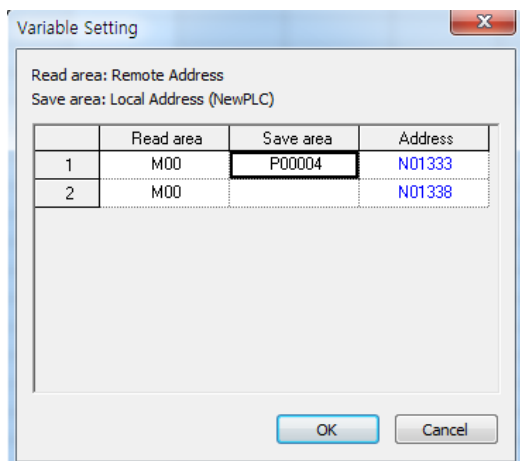

1.7.5 XGT client

XGT client is the function to Read/Write Data, which transmits the request frame to the server through XGT dedicated protocols. It transmits the frame when the startup conditions of each block set in parameters are On. In the case of XBL-EMTA, you can use the XGT client function in two ways; TCP and UDP.

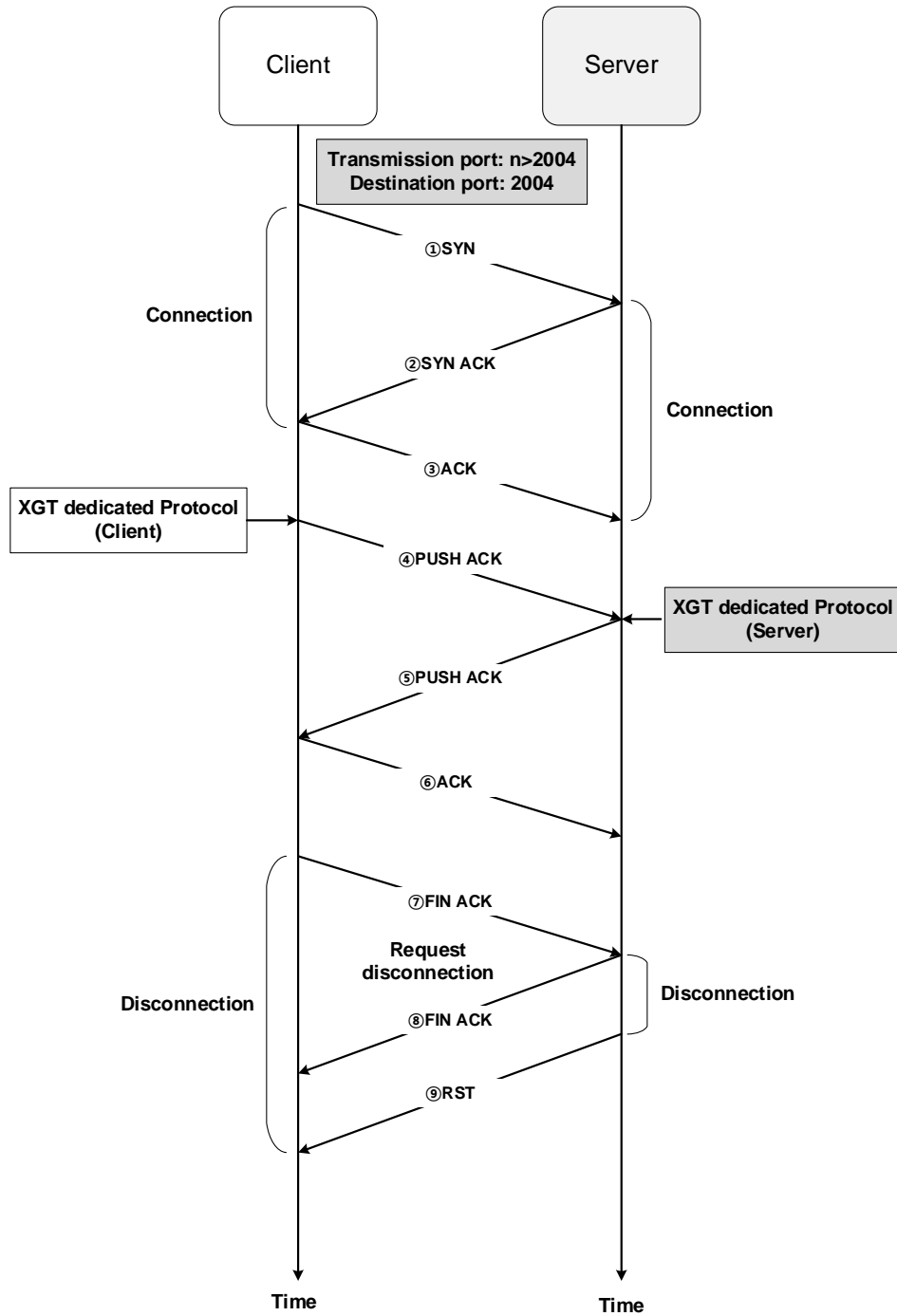

<Setting TCP XGT client channel>

1.7.6 Modbus TCP client

It is the function to Read/Write Data, which transmits the request frame to the server by using function code based on Modbus TCP/IP protocol. It transmits the frame when the startup conditions of each block set in parameters are On.

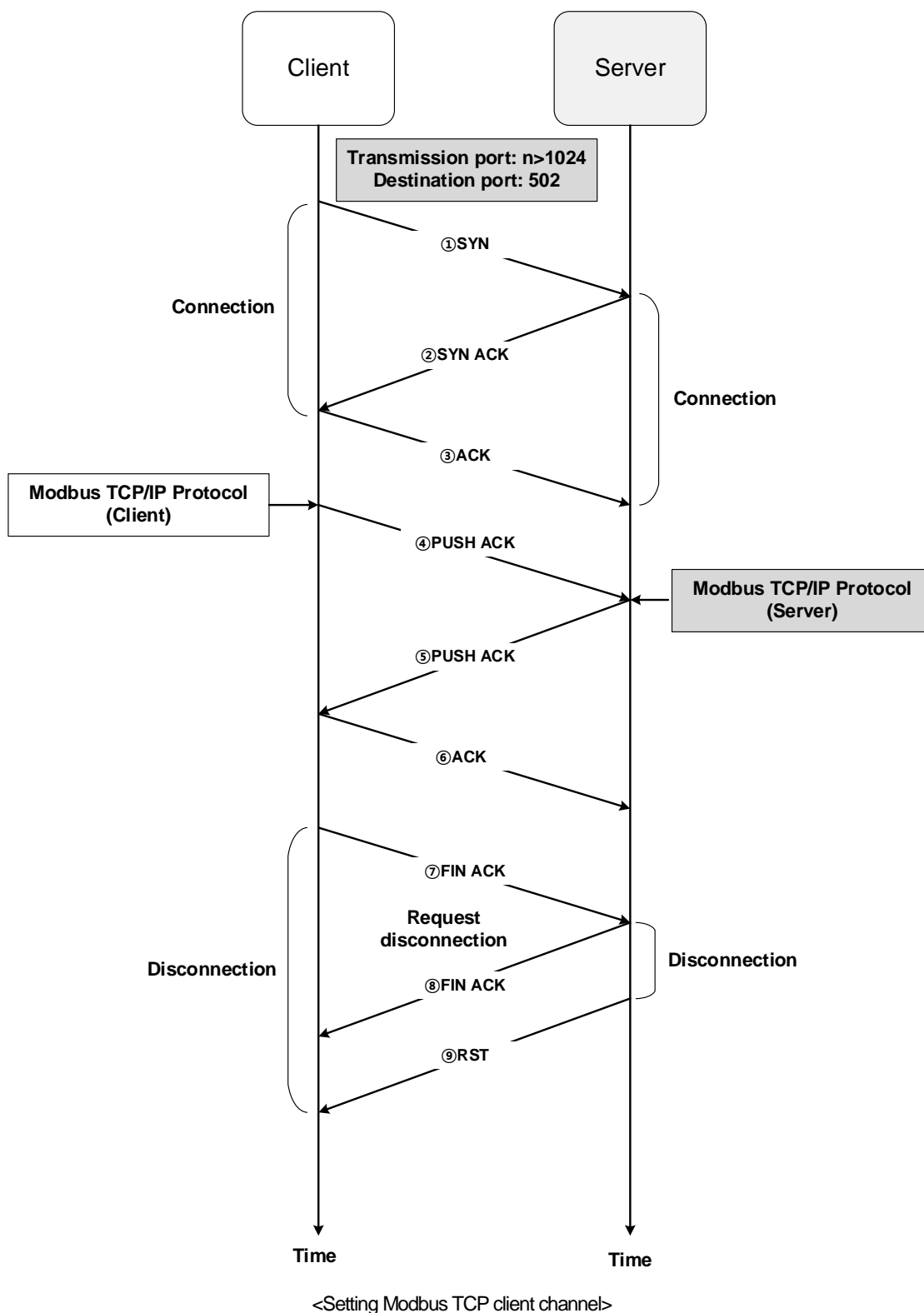

1.7.7 User-defined frame

If you want to transmit the user's desirable frame or receive one among the frames of the network, you need to define the relevant transmission/reception frame. The function is available in the P2P service only. All frames are composed of Header, Data, Tail and each element can be omitted.

The user-defined frame is expressed as the group name and frame name. Each meaning is as below.

1) Group

It is the set of frames having the same Headers and Tails. To register frames, you need to register groups.

(1) Adding groups of user-defined frame

After choosing the user-defined frame as below, click the right mouse button. Select "Add a Group" in the popup menu for adding items.

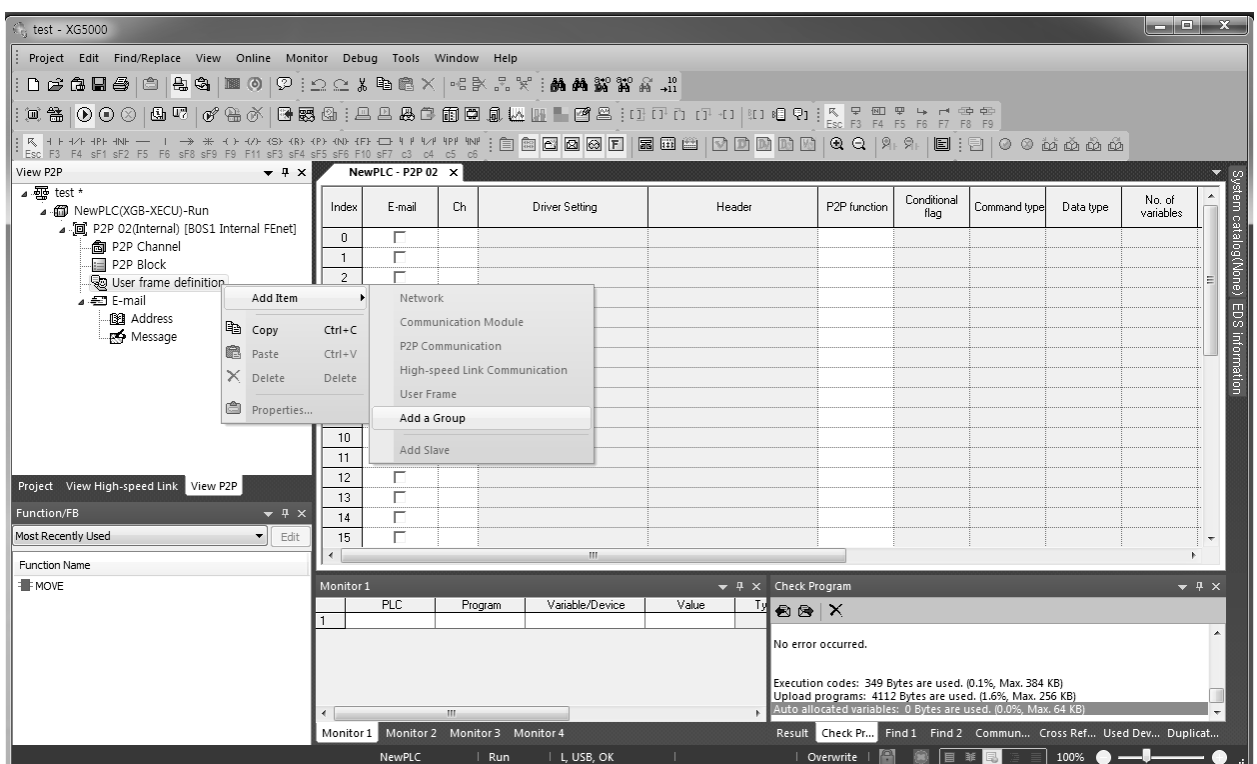

(2) Selecting group names and frame types of the user-defined frame

Enter the group name in the group edition menu and select the frame type. You can input the group name discretionally.



< Selecting group names and frame types of the user-defined frame >

The below figure shows the results of the project window when selecting “SEND” of the group name, transmission frame.

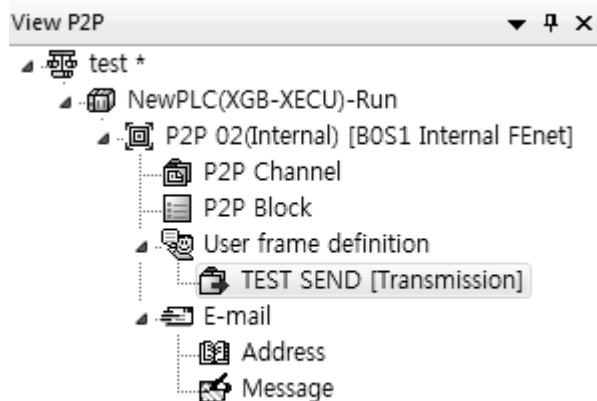

< Completion of adding groups of the user-defined frame >

2) Frame

- It is composed of the Head, Body, Tail.
- It defines the transmission · reception frames.
- You can add the fixed·variable sized variables to the Body.
- The frame is composed of multiple segments and you can register the maximum of 4 variable segments to one Body.

(1) Adding frames to the groups

If you click the right mouse button on the added group as below, the popup menu will come on. Choose 'Add Frames' and choose the frame types. The below figure represents the added frames to the group when you select HEAD, TAIL, BODY respectively.

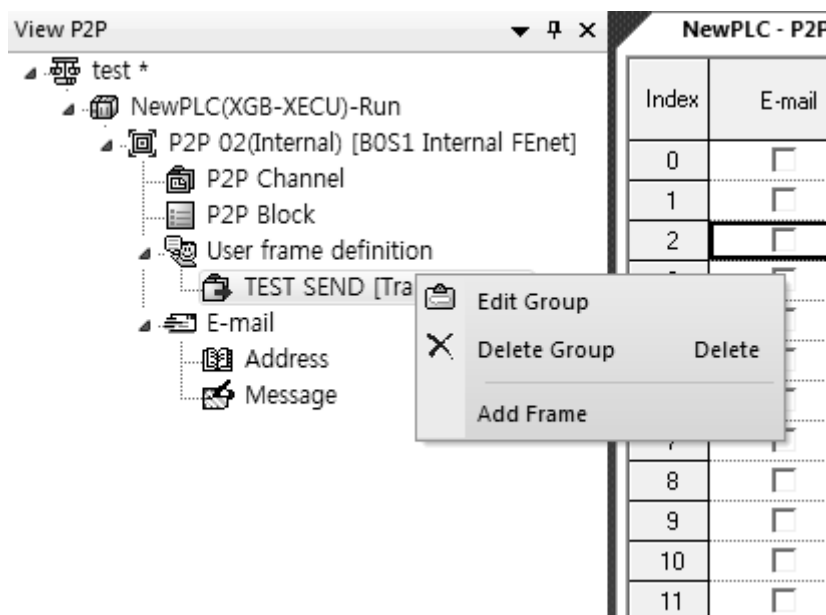

< Adding the transmission frame of the user-defined frame >

a) Adding the user-defined frame's HEAD

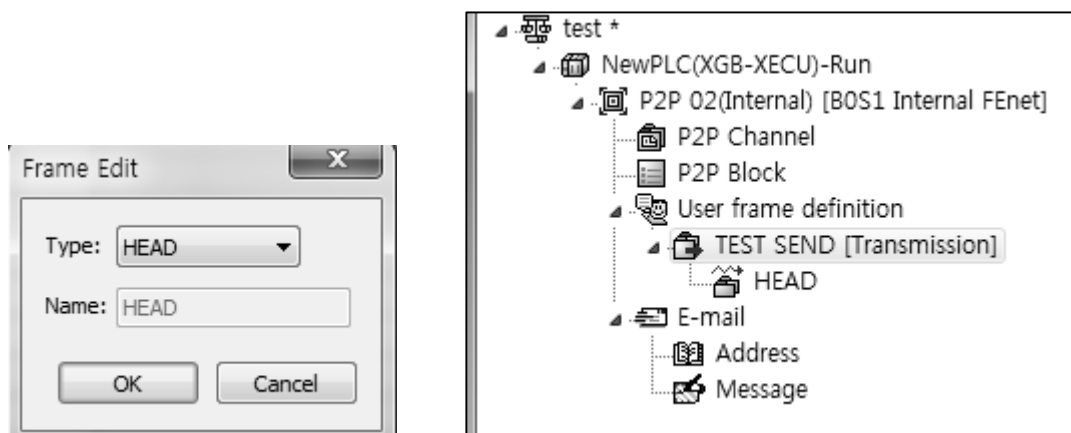

< Adding the use defined frame's HEAD >

(2) Adding the user-defined frame's TAIL

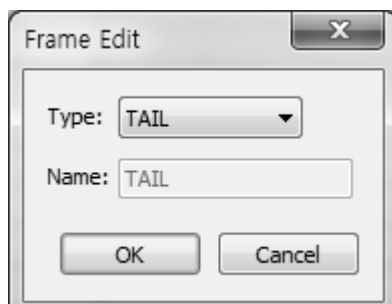

(3) Adding the user-defined frame's BODY

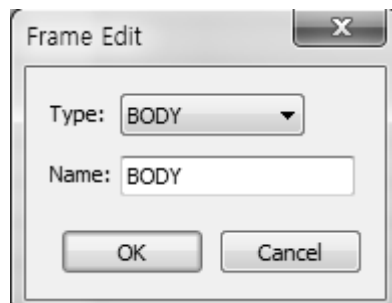

3) Segments

(1) Kind of segments

The frame's Headers, Bodies, Tails are composed of multiple segments. You can add segments by clicking the right mouse button.

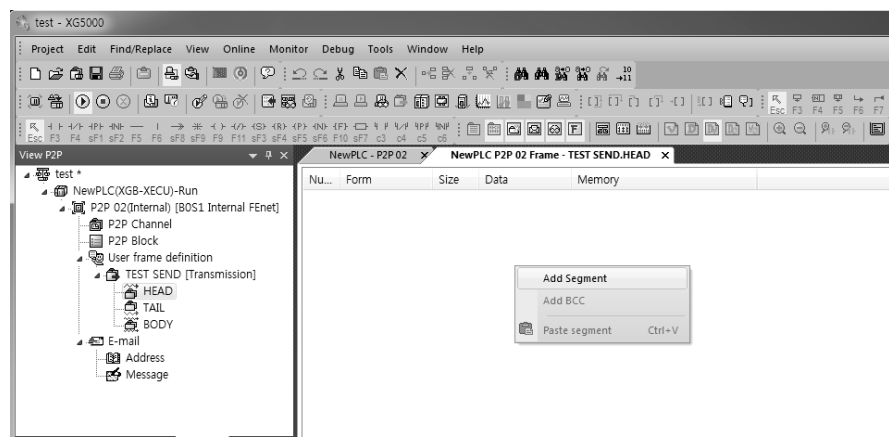

Number	Form	Size	Data	Memory
00	String Constant	4	1324	

< Example of the window where the segment is registered >

There are the numerical constant, string constant, fixed · variable sized variables for the segments forming the frames.

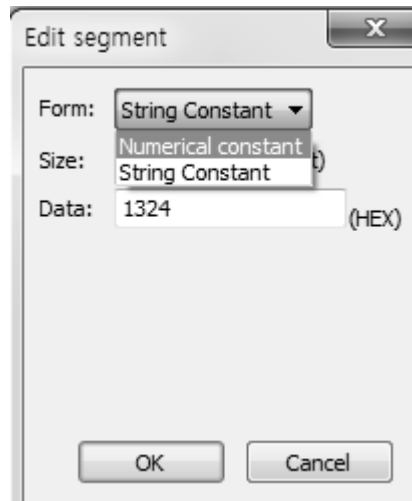

<Adding segment>

a) Numerical constant

It defines the part that is fixed as the constant among frames and the value of data term should be designated as Hex.

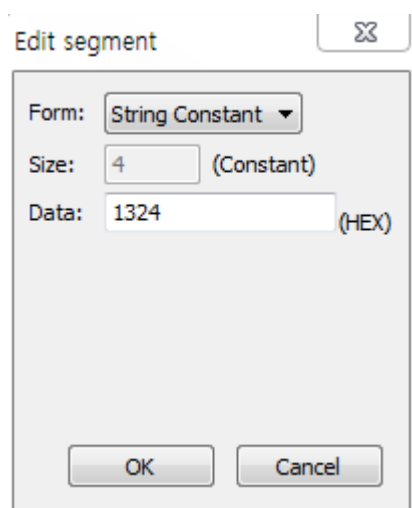

b) String constant

Register the string constant among frames and designate the value of data term as ASCII.

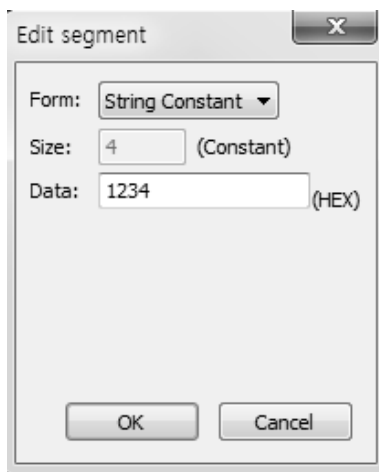

c) Fixed size variables

The fixed size variables can be used for the frame's Body area only. It is used when you process the data as much as the defined size among the received frames. If you check memory specification, it can be saved to the PLC memory. At this time, data values can be changed, swapped.

d) Variable size variables

- They can be used for the frame's Body area.
- Transmission frame: It is used to change the frame length. If you check memory specification, the transmission frame will be composed of the data read from the PLC memory.
- Reception frame

It is used to process variable sized data among received frames.

It can be registered to the last segment among the Body areas. If you check memory specification, the data for the corresponding segment will be saved among received frames (it also can be swapped and changed)

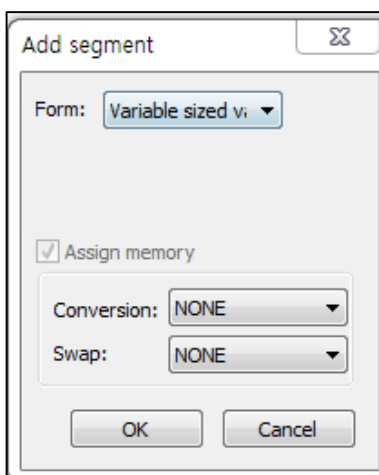

(2) Data conversion processing

In case you need to convert the data into ASCII from Hex during transmission-reception of frames or execute Byte Swap, it can be defined in the frame editing frame.

a) Conversion

(a) Hex To ASCII

- Transmission: Converts the data read from the PLC memory into ASCII and composes the transmission frame
- Reception: Converts the received data into ASCII and saves it.

(b) ASCII To Hex

- Transmission: Converts the data read from the PLC memory into Hex and composes the transmission frame.
- Reception: Converts the received data into Hex and saves it.

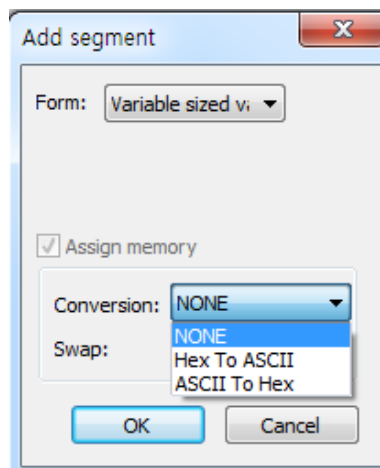

For configuring the transmission frame, in CASE you use the PLC memory MW100's 2word and convert it into Hex to ASCII or in case h34353637 is saved in MW100, the corresponding segment of the transmission frame will be made of "4567".

In addition, when you convert the part of the received frames into Hex and save it, if the value of the corresponding area is "4567", h34353637 will be saved to the PLC memory.

b) Swap

(a) 2byte

- Swapping the corresponding part of transmission · reception frames by 2 bytes

(b) 4byte

- Swapping the corresponding part of transmission · reception frames by 4 bytes

(c) 8byte

- Swapping the corresponding part of transmission · reception frames by 8 bytes

* h1234567811223344 can be converted by each method as below.

- 2byte Swap: h3412785622114433
- 4byte Swap: h7856341244332211
- 8byte Swap: h4433221178563412

4) TCP/UDP user-defined frame server

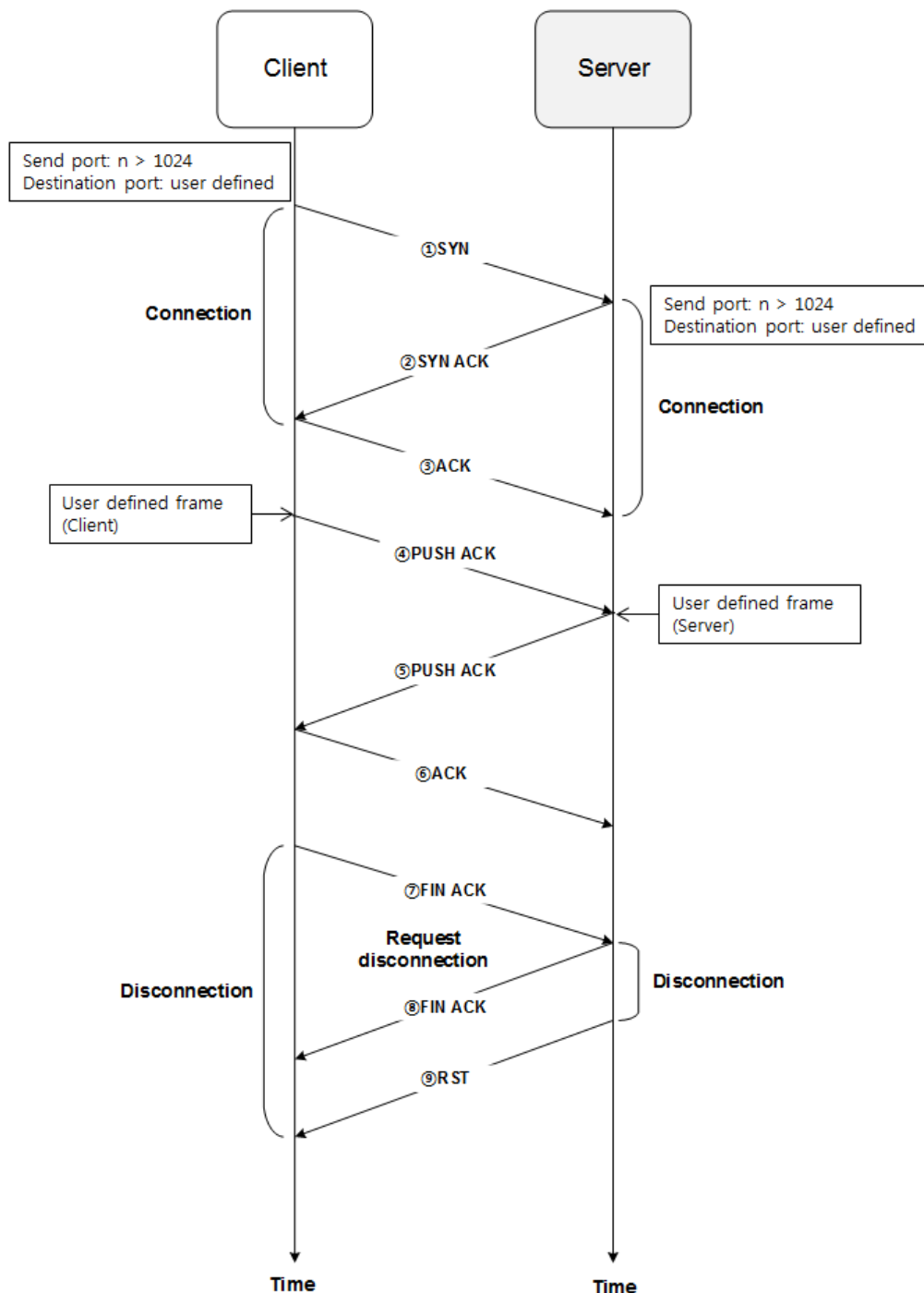

▪<TCP user-defined frame server>

- (1) It is the function to receive the frame registered in the transmission block to the port designated by a user.
- (2) After the access request is received from the client and connection is completed, when the frame registered in the reception block is received from the client, the corresponding block will be processed.
- (3) In case the ports or frame forms are different, reception process is not available.
- (4) In the case of UDP user frame server, when the frame registered in the reception block is received to the port, it will be processed.

5) TCP/UDP user-defined frame client

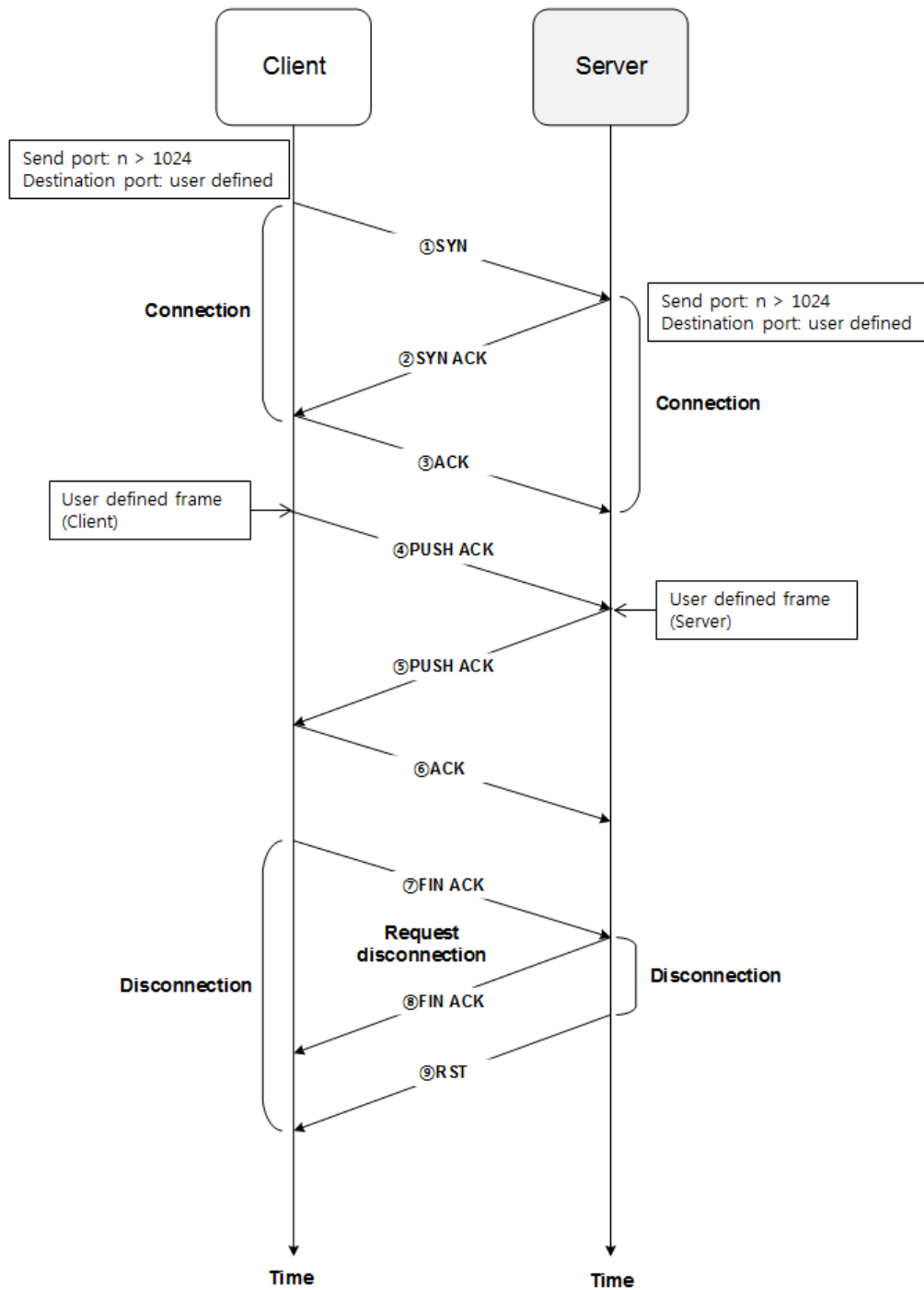

<TCP user-defined frame client>

- 1) It is the function to transmit the frame that is registered in the transmission block to the port designated by a user.
- 2) If the startup conditions of the block are On, the connection request will be sent to the server and the frame registered in the transmission block will be sent to the corresponding port.
- 3) In the case of UDP, when the startup conditions are On to the corresponding port without connection request, the frame will be transmitted.

1.7.8 Operation of P2P service

After setting P2P parameters, you need to download the parameters to the PLC's CPU and start up the P2P service. Assume that the P2P parameters to be downloaded are already made and accesses to the PLC's CPU.

1) P2P parameter download

If you choose [Online] -> [Write] in the XG5000 menu to download the completed P2P parameters, the window for parameters download will pop up. If you click the 'OK' button, the communication parameters will be downloaded to the CPU. if you check 'Set up with Link Enable', Link Enable can be applied with writing P2P/HS parameters at the same time.

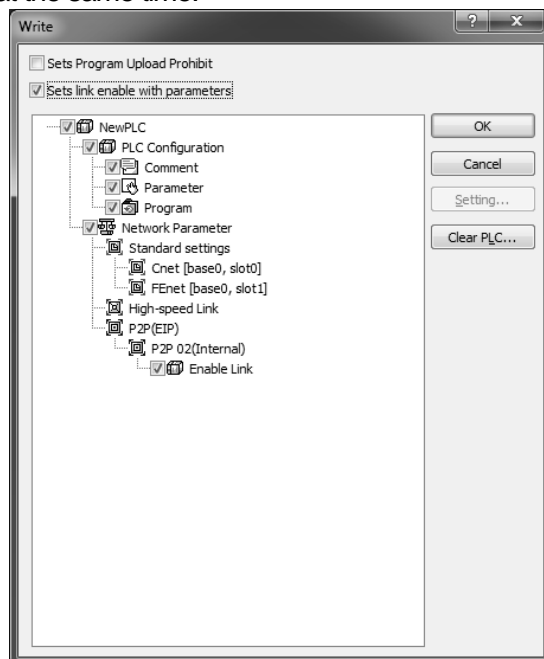

(1) Startup of P2Pservice

After downloading P2P parameters, you need to start up P2P for P2P service. To achieve this, choose [Online] → [Communication Module Setting] → [Link Enable (high speed link, P2P)] in the menu.

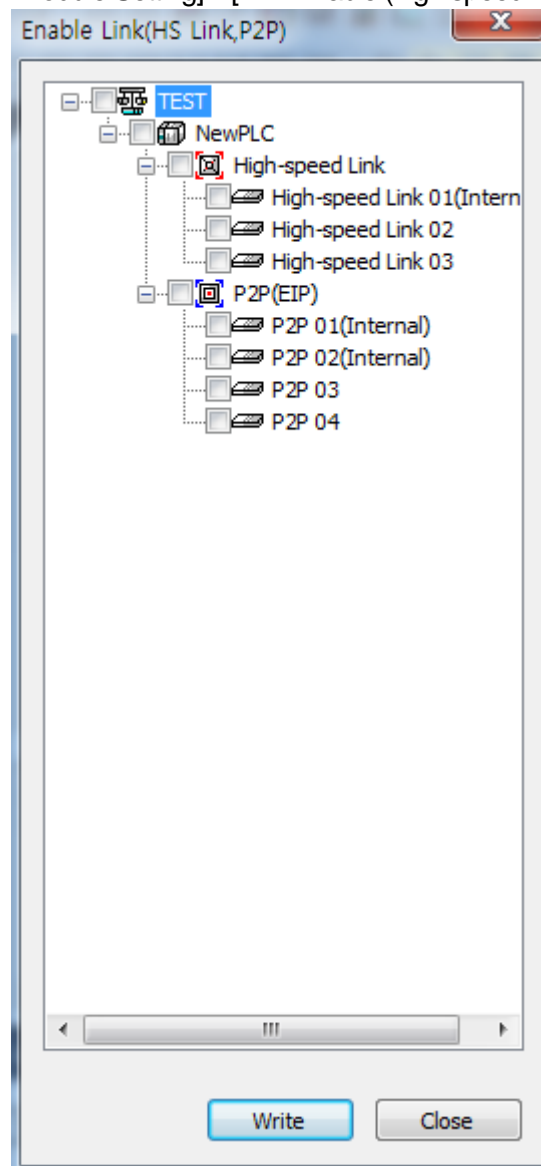

Choose the P2P parameters to be started in the [link Enable (high speed link, P2P)] window. If you cancel the already checked P2P parameter, the relevant P2P service will stop.

1.7.9 P2P diagnosis function

- 1) Click the System Diagnosis as shown in the left figure after access through XG5000.
- 2) Then, the current system is displayed as shown in the right figure.

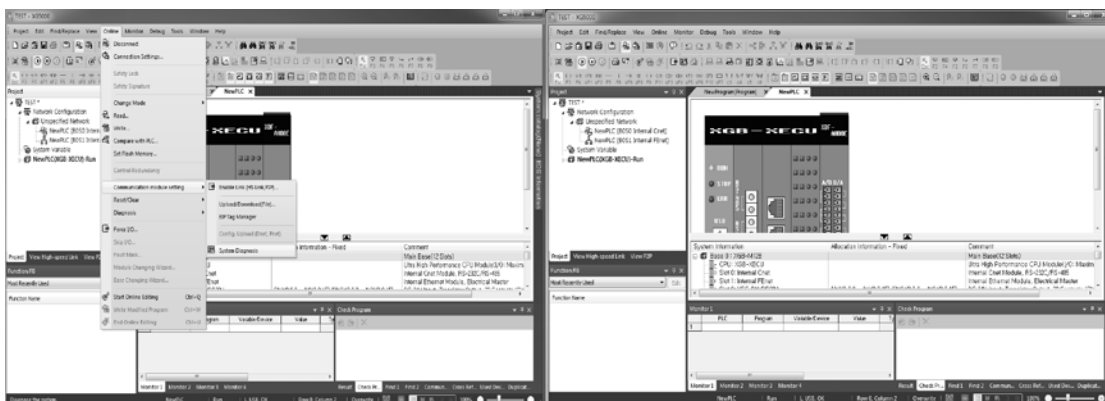

- 3) Put the mouse on the figure of the module and click the right mouse button as shown in the left side of the below figure.
- 4) Choose the status by services and click them.

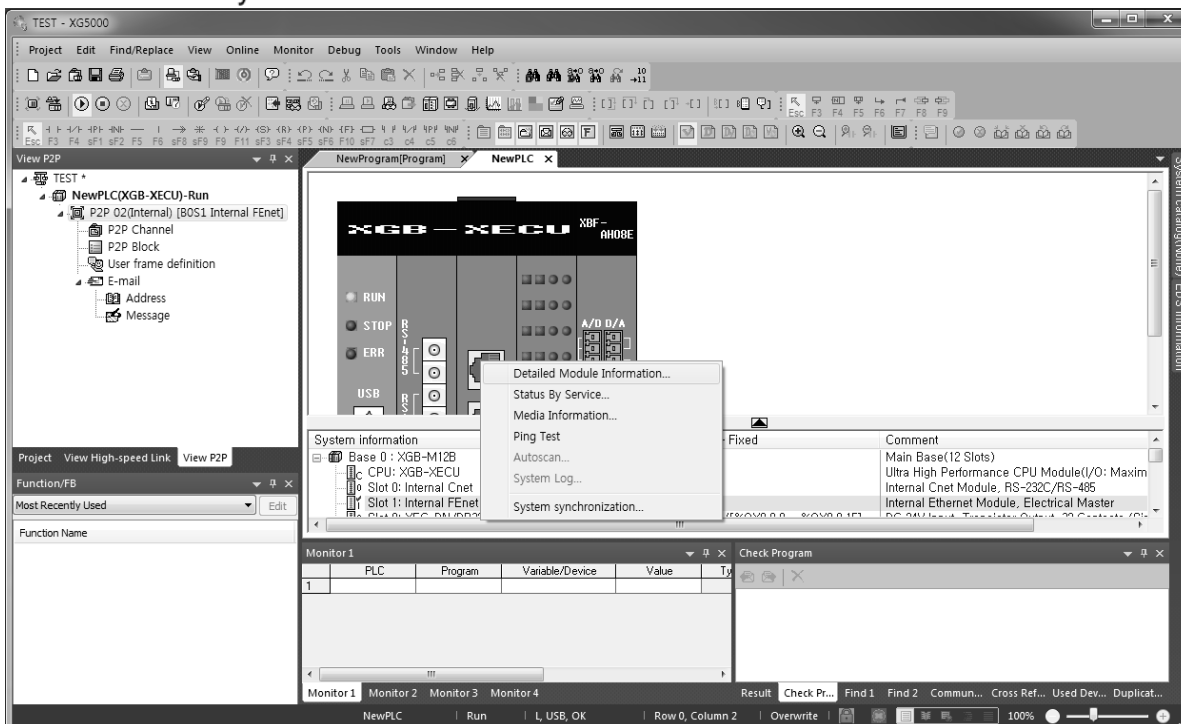

5) Then, the status window by service is displayed.

6) If you select the P2P service tab, you can check the status of P2P service as below.

The screenshot shows a software window titled "Status by service" with three tabs: "Dedicated Service", "P2P Service" (selected), and "HS Link Service".

Standard Information

Base No.:
Slot No.:

Service Information

Parameter existence: No. of blocks in service:
Parameter task status:

Communication Diagnostics

Block number	Channel number	Block status	Connection status	Service status	Service count	Error count
0	0	0	IDLE	0	0	0
1	0	0	IDLE	0	0	0
2	0	0	IDLE	0	0	0
3	0	0	IDLE	0	0	0

Buttons: Multiple Reading, Refresh, Close

1.8 High speed link

1.8.1 Outline

The high speed link that is the communicate method between XGB PLC and XGK PLC's communication module is the function to transmit and receive data regularly by setting high speed link parameters. The high speed link service transmits the frame to Subnet Broadcast by using UDP protocols.

The device that is in the same subnet receives the Broadcast frame and if the relevant frame is registered in the reception list, the data will be processed. The functions of the high speed link are as below.

1) Function for setting the high speed link block

If there are several transmission · reception areas, you can set the blocks up to 64. It is possible to set 200 words per one block.

2) Function for setting the transmission cycle

A user can set the transmission cycle by parameters. It is possible for a user to set the transmission · reception cycle from 20ms to 10 seconds.

3) Function for setting transmission · reception areas

You can set the transmission · reception areas by data blocks. It is possible to use the maximum of 64 blocks without distinction of transmission · reception.

4) Function for providing the high speed link information

You can check the operating status of the high speed link through flags.

You also can use the convenient diagnosis function through XG5000.

1.8.2 Parameters setting

1) Basic parameters

- (1) When creating the XG5000 project, any RUN communication modules are not registered in the basic network.

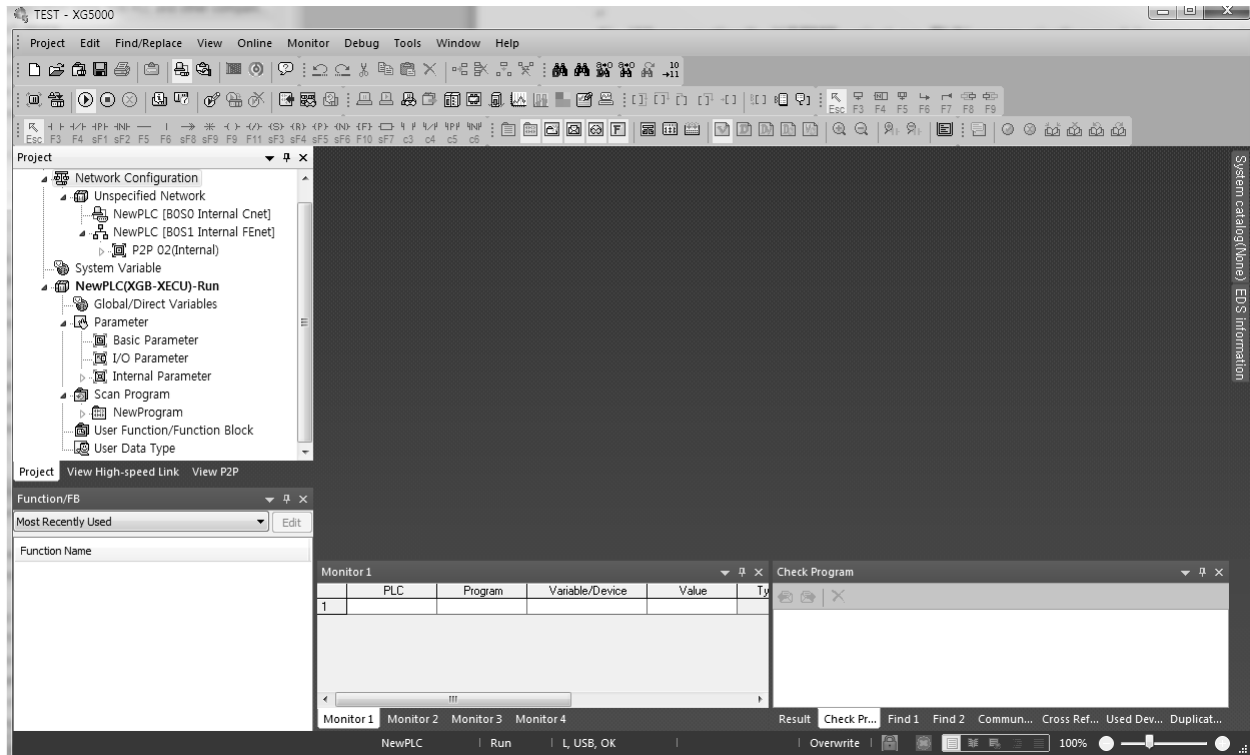

[Fig. 1.8.1] Creation of XG5000 project

(2) If you execute I/O synchronization in [online]→[diagnosis]→[I/O information] after accessing to the PLC, even the currently installed expansion communication module including built-in communication will be registered.

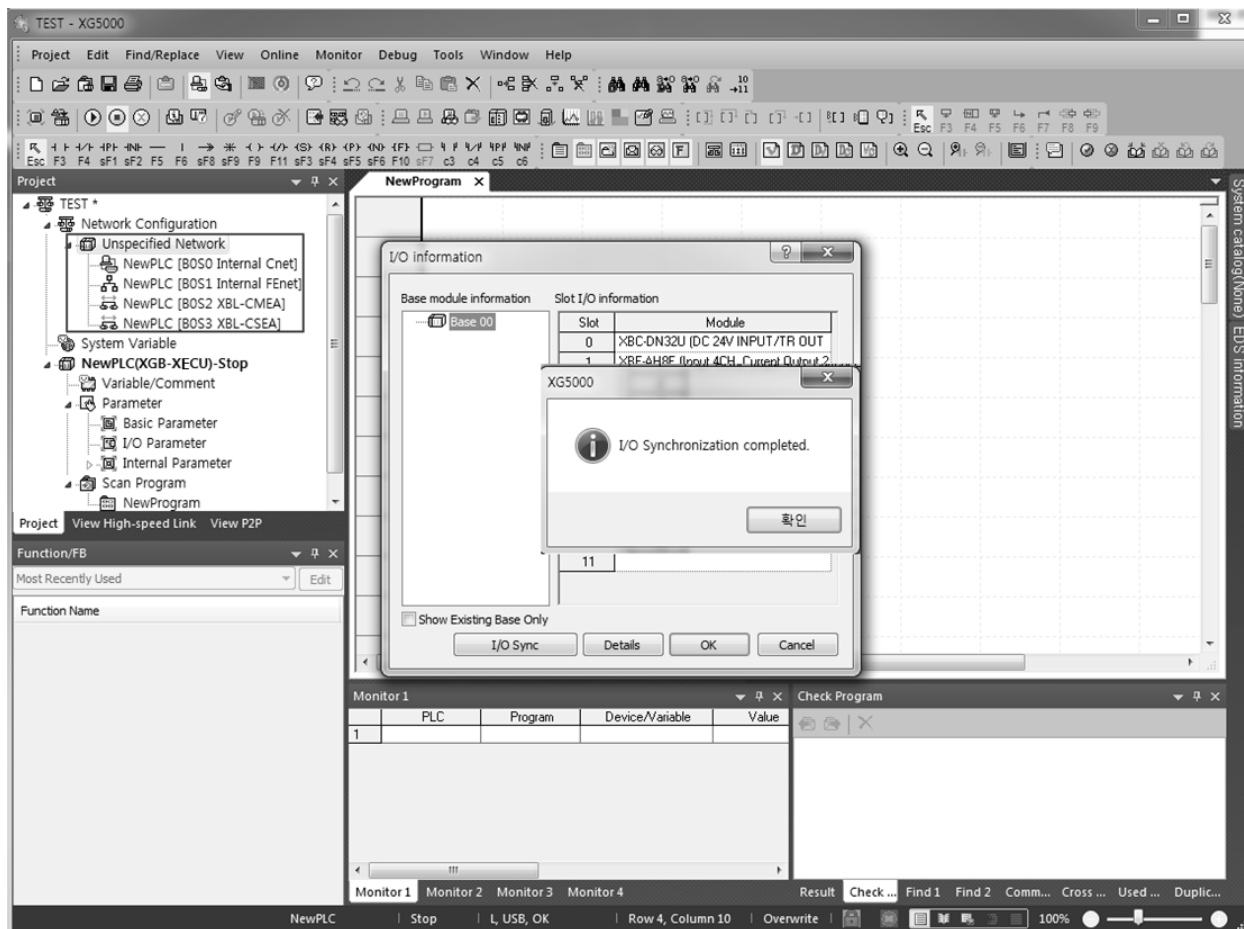

[Fig. 1.8.2] Registration of XG5000 project communication module

- (3) Double-click the built-in Fenet and input high speed link's exchange number and network parameter information.

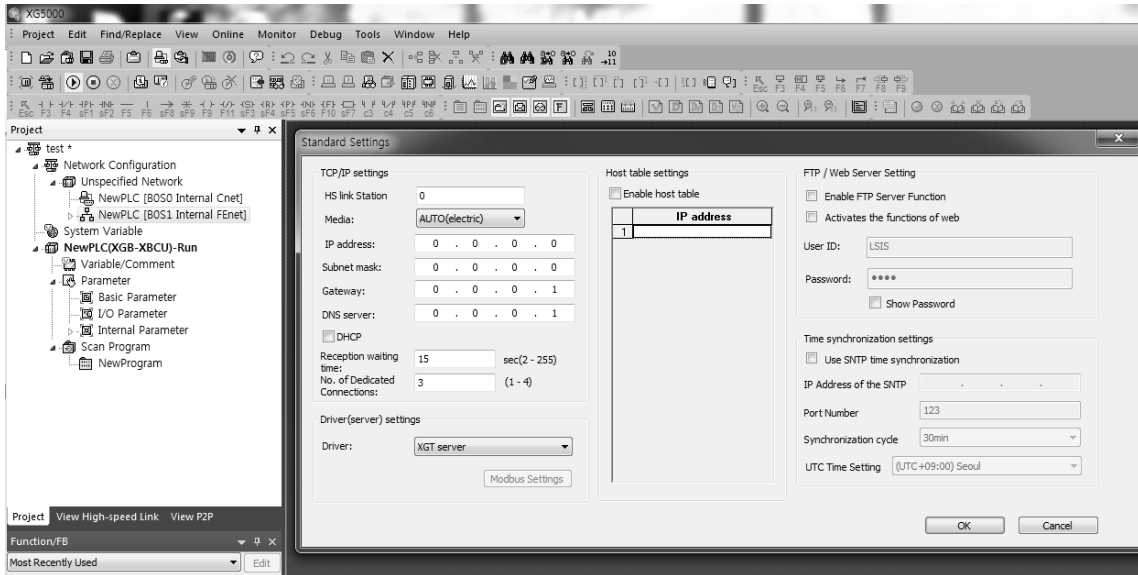

[Fig. 1.8.3] Setting the basic communication module

2) High speed link parameter

(1) Communication setting

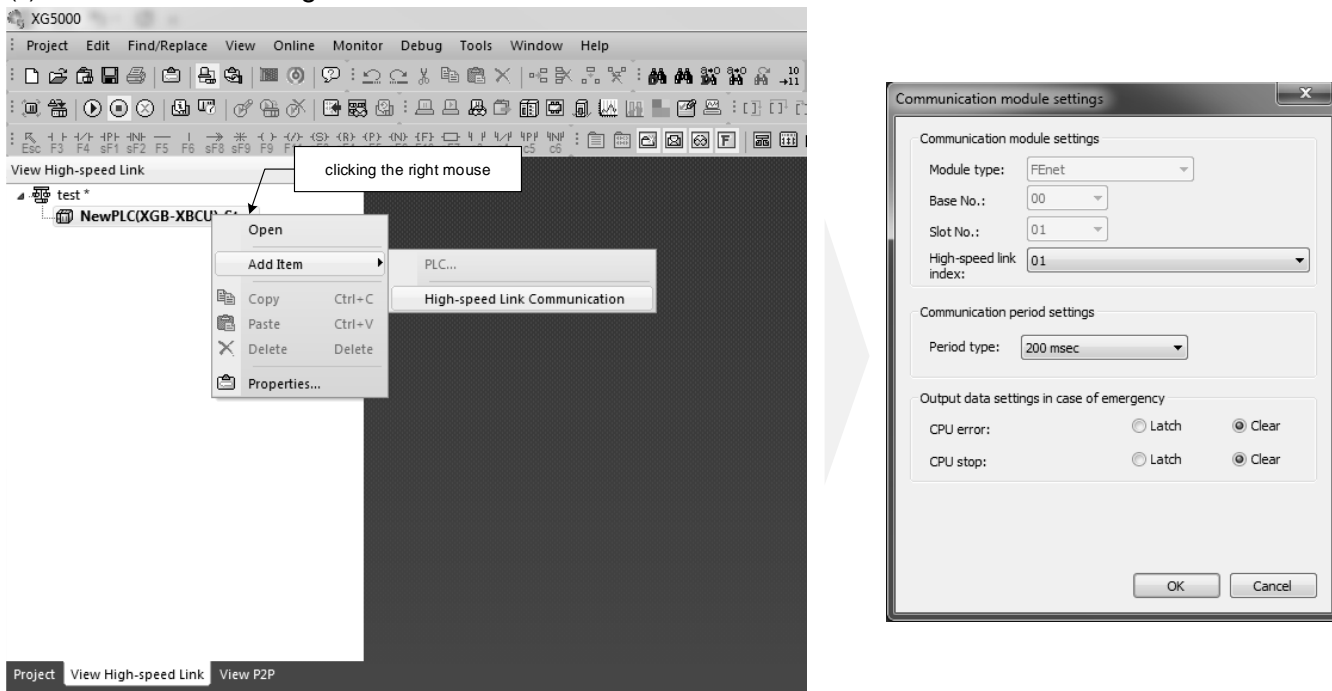

[Fig. 1.8..4] Basic setting of high speed link

- After clicking the right mouse on the high speed link tab, add high speed link communication items as shown in the left side of the figure[1.8.4].
- Then, the window for setting communication modules is activated as shown in the right side of the figure[1.8.4] and you can set the basic high speed link. No.01 high speed link is the built-in FEnet and No. 02 and 03
- high speed links can be used for expansion communication modules as before.

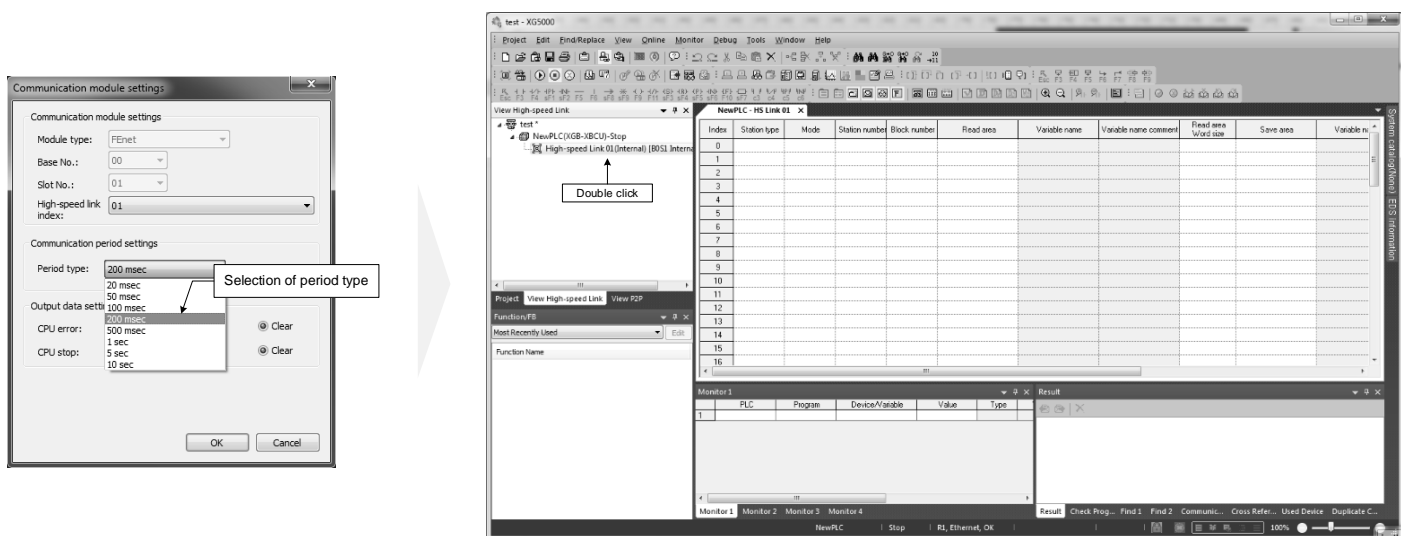

[Fig. 1.8.5] Completion of setting high speed link communication module

- d) Select the cycle to be communicated in communication cycle setting as shown in the left side of [Fig. 1.8.5].
- e) Choose the cycle and click 'OK' button. Then, if you double-click the No.1 module of high speed link, the window for setting block will be displayed as shown in the right side of [Fig. 1.8.5].

(2) Setting the high speed link transmission block

Index	Station type	Mode	Station number	Block number	Read area	Variable name	Variable name comment	Read area Word size	Save area	Variable name	Variable name comment	Save area Word size
0	MASTER	Send	1	0	M0000			10				
1												
2												
3												
4												
5												
6												
7												
8												
9												
10												
11												

[Fig. 1.8.6]Setting high speed link transmission block

- a) Set the station type as MASTER
- b) Choose the transmission mode
- c) If you choose transmission, it will be automatically set as the exchange number set in the basic parameters.
- d) Input the block number(range: 0~31).
- e) Input the area to be read.The area to be read is the each area of XGB's CPU modules.
- f) If you input the word size of the area to be read, setting transmission blocks is completed.

(3) Setting high speed link reception block

Index	Station type	Mode	Station number	Block number	Read area	Variable name	Variable name comment	Read area Word size	Save area	Variable name	Variable name comment	Save area Word size
0	MASTER	Receive	10	1					M0020			10
1												
2												
3												
4												
5												
6												
7												
8												
9												
10												

[Fig. 1.8.7] Setting high speed link reception block

- a) Set the station type as MASTER as show in [Fig. 1.8.7].
- b) Choose the mode as reception.
- c) Input the exchange number. This one is the exchange number of the opposing device transmitting the relevant block.
- d) Input the block number. When the received frame is the same as the relevant block number, reception is processed.
- e) Input the storage area. The storage area is the area saving data when the frames of the relevant block
- f) Numbers are received to each area of XGB CPU modules.
- g) If you input the word size of the data to be read, setting reception block is completed.

(4) HS parameter download

If you choose [Online] -> [Write] in the XG5000 menu to download the completed HS parameters, the window for parameters download will pop up. If you click the 'OK' button, the communication parameters will be downloaded to the CPU. If you check 'Set up with Link Enable', Link Enable can be applied with writing P2P/HS parameters at the same time.

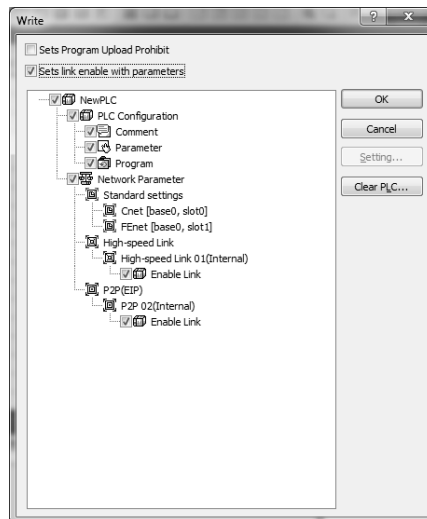

(5) High speed link Enable

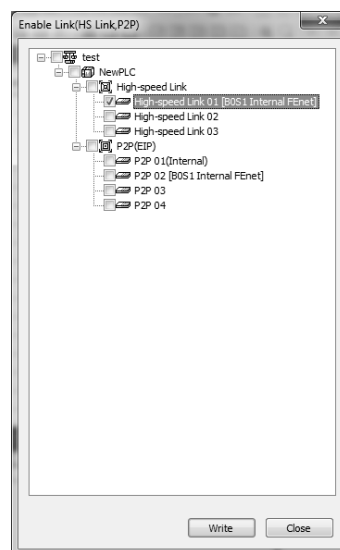

a) Choose [Online]→[Communication module setting]→[Link Enable] after accessing to the PLC through XG5000.

b) Choose high speed link 01 that built-in FEnet is designated as the base.

c) After clicking the checkbox, click 'Write' button.

d) If you click the 'OK' button after the message is output, high speed link communication will start.

3) High speed link flag

The high speed link service is the function for data exchange between communication modules of more than two stations. For a user's information, it provides the way how to check the status of the high speed link service aiming to verify the reliability of the data read from the opposing station through the high speed link.

For the high speed link information, the communication module inform a user whether the high speed link is operated based on the parameters set by the user by synthesizing received data every a certain time.

The high speed link information can be divided into RUN-link (`_HSxRLINK`) showing the information of the whole communication network; Link-Trouble (`_HSxLTRBL`)'s whole information; `_HSxSTATUS`, `_HSxTRX`, `_HSxMOD`, `_HSxERR`'s individual information showing the communication status by 64 registered items of the parameters.

A user can use the above information during programming in the format of keywords and monitor the status of the high speed link by using the monitoring function. When operating several PLCs with the high speed link, you need to verify the reliability of the transmitted/received data by using the high speed link information such as RUN-link, link-Trouble, etc.

[Table 1.8.1] shows the functions and definitions of the high speed link information.

Items	RUN-Link	Link-Trouble	Transmission · reception status	Operation mode	Error	Status of high speed link
Information type	General information	General information	Individual information	Individual information	Individual information	Individual information
Keyword name (x=high speed link No.)	<code>_HSxRLINK</code>	<code>_HSxLTRBL</code>	<code>_HSxTRX[n]</code> (n=0..64)	<code>_HSxMOD[n]</code> (n=0..64)	<code>_HSxERR[n]</code> (n=0..64)	<code>_HSxSTATUS[n]</code> (n=0..64)
Data type	Bit	Bit	Bit-Array	Bit-Array	Bit-Array	Bit-Array
Monitoring	Available	Available	Available	Available	Available	Available
Use of programs	Available	Available	Available	Available	Available	Available

[Table 1.8.1] High speed link flag

(1) RUN link flag

It is the whole information showing whether the high speed link works normally based on the parameters set by the user. It is the contact that maintains the status of 'On' until Link Enable is 'Off' once it is 'On'. It is 'On' under the following conditions.

- In case Link Enable is 'On'.
- In case all parameter registering lists are set normally
- In case all relevant data is transmitted and received to the parameter registering list based on the set cycle.
- In case the status of all opposing stations set in the parameters is RUN with no error.

(2) Trouble link flag

It is the information showing whether the high speed link works normally based on the parameters set by the user. Under the situation of RUN-link On, when the conditions of RUN-link On are violated, it will be 'On'; when the conditions are recovered, it will be 'off'.

(3) Flag displaying the general status of the blocks

It is the individual information showing the operating status of the resisted lists of the high speed link parameters. It displays the status of high speed link by registered lists up to 64 like the maximum number of registrations. It displays the general information for the registered lists by synthesizing individual information of each item. When the transmission · reception status of the relevant list is normal and the operation mode is RUN with no error, it will be 'On'; when the above items are violated, it will be 'Off'.

(4) RUN operating mode flag of the block station

It is the individual information showing the operating status of the resisted lists of the high speed link parameters. It displays the operating mode information by registered lists up to 64 like the maximum number of registrations. When the station of the registered items is under Run mode, the relevant bit will be 'On'; when the station is under Stop/Pause/Debug mode, it will be 'Off'.

(5) Flag displaying the block station and normal communication

It is the individual information showing the operating status of the resisted lists of the high speed link parameters. It displays the transmission · reception information of the registered list up to 64. When the transmission · reception operation works based on the cycle, the relevant bit will be 'On'; when the operation does not work normally, it will be 'Off'.

(6) Operation error mode flag of the block station

It is the individual information showing the operating status of the resisted lists of the high speed link parameters. It displays the error information of the registered list up to 64 the maximum number of registrations. The error synthetically indicates the situation that the PLC cannot execute the user programs normally. When it is Off, it means the opposing station's PLC works normally; when it is On, it means the opposing station is abnormal.

4) Limitation of the high speed link's transfer rate

The below table indicates the limitation guaranteeing the high speed link's transmission speed. When you set the high speed link, refer to the below table to determine the communication load. In case of going out of the limitation, the data may be transferred, exceeding the transmission cycle.

(Communication speed: 100Mbps)

Based on 200 words per block			Based on 100 words per block			Based on 50 words per block		
Cycle	Scan time	Blocks No.	Cycle	Scan time	Blocks No.	Cycle	Scan time	Blocks No.
20 ms	Less than 1 ms	12 blocks	20 ms	Less than 1 ms	24 blocks	20 ms	Less than 1 ms	32 blocks
	Less than 2 ms	8 blocks		Less than 2 ms	16 blocks		Less than 2 ms	32 blocks
	Less than 5 ms	4 blocks		Less than 5 ms	8 blocks		Less than 5 ms	16 blocks
	Less than 10 ms	1 block		Less than 10 ms	4 blocks		Less than 10 ms	8 blocks
50 ms	Less than 1 ms	32 blocks	50 ms	Less than 1 ms	32 blocks	50 ms	Less than 1 ms	32 blocks
	Less than 2 ms	24 blocks		Less than 2 ms	32 blocks		Less than 2 ms	32 blocks
	Less than 5 ms	12 blocks		Less than 5 ms	24 blocks		Less than 5 ms	32 blocks
	Less than 10 ms	8 blocks		Less than 10 ms	12 blocks		Less than 10 ms	24 blocks
100 ms	Less than 1 ms	32 blocks	100 ms	Less than 1 ms	32 blocks	100 ms	Less than 1 ms	32 blocks
	Less than 2 ms	32 blocks		Less than 2 ms	32 blocks		Less than 2 ms	32 blocks
	Less than 5 ms	24 blocks		Less than 5 ms	32 blocks		Less than 5 ms	32 blocks
	Less than 10 ms	12 blocks		Less than 10 ms	32 blocks		Less than 10 ms	32 blocks

Based on 200 words per block			Based on 100 words per block			Based on 50 words per block		
Cycle	Scan time	Blocks No.	Cycle	Scan time	Blocks No.	Cycle	Scan time	Blocks No.
200 ms	Less than 1 ms	32 blocks	200 ms	Less than 1 ms	32 blocks	200 ms	Less than 1 ms	32 blocks
	Less than 2 ms	32 blocks		Less than 2 ms	32 blocks		Less than 2 ms	32 blocks
	Less than 5 ms	32 blocks		Less than 5 ms	32 blocks		Less than 5 ms	32 blocks
	Less than 10 ms	32 blocks		Less than 10 ms	32 blocks		Less than 10 ms	32 blocks
500 ms	Less than 1 ms	32 blocks	500 ms	Less than 1 ms	32 blocks	500 ms	Less than 1 ms	32 blocks
	Less than 2 ms	32 blocks		Less than 2 ms	32 blocks		Less than 2 ms	32 blocks
	Less than 5 ms	32 blocks		Less than 5 ms	32 blocks		Less than 5 ms	32 blocks
	Less than 10 ms	32 blocks		Less than 10 ms	32 blocks		Less than 10 ms	32 blocks
1s	Less than 1 ms	32 blocks	1s	Less than 1 ms	32 blocks	1s	Less than 1 ms	32 blocks
	Less than 2 ms	32 blocks		Less than 2 ms	32 blocks		Less than 2 ms	32 blocks
	Less than 5 ms	32 blocks		Less than 5 ms	32 blocks		Less than 5 ms	32 blocks
	Less than 10 ms	32 blocks		Less than 10 ms	32 blocks		Less than 10 ms	32 blocks
5s	Less than 1 ms	32 blocks	5s	Less than 1 ms	32 blocks	5s	Less than 1 ms	32 blocks
	Less than 2 ms	32 blocks		Less than 2 ms	32 blocks		Less than 2 ms	32 blocks
	Less than 5 ms	32 blocks		Less than 5 ms	32 blocks		Less than 5 ms	32 blocks
	Less than 10 ms	32 blocks		Less than 10 ms	32 blocks		Less than 10 ms	32 blocks
10s	Less than 1 ms	32 blocks	10s	Less than 1 ms	32 blocks	10s	Less than 1 ms	32 blocks
	Less than 2 ms	32 blocks		Less than 2 ms	32 blocks		Less than 2 ms	32 blocks
	Less than 5 ms	32 blocks		Less than 5 ms	32 blocks		Less than 5 ms	32 blocks
	Less than 10 ms	32 blocks		Less than 10 ms	32 blocks		Less than 10 ms	32 blocks

※ The above values are based on using high speed link only

1.9 Remote communication

1.9.1 Outline

It is the function to realize remotely programming, user program download, program debugging, monitor, etc. in the network system where the PLCs are connected with each other through Ethernet without moving physical connection of XG5000.

For the devices that are far from the network, it is the convenient function to access to each device in one place without translocation. You can execute XG5000's remote communication service by creating the logical path as below.

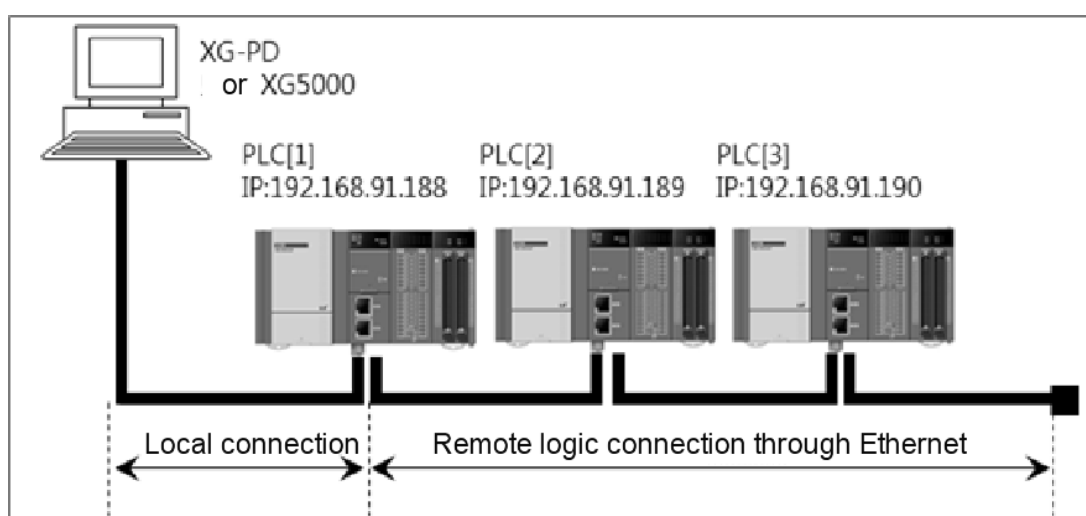

If the Ethernet module is installed in the PC where XG5000 is running and it is connected to the same network with the PLC in the above figure, you can perform the remote 1-stage access through Ethernet. Assume that the Ethernet cables are connected to the PLC #1 station in XG5000 and PLC #1, PLC #2, PLC #N are connected with each other through Ethernet.

To access the details of the PLC #N station in the above figure, set the access method as Ethernet in access setting of XG5000's online menu and input the relevant PLC #N station's IP and remote stage. In this status, you can realize all functions in the PLC #1 such as programming, download, debugging and monitor, etc.

If you use XG5000's remote communication service, you can access easily without moving to the distant PLC. In addition, although the PLC is located in the inaccessible position, it is possible to access from the other PLC so easy access can be realized after installation.

1.9.2 Setup and Access of XG5000

You can access all PLCs that access to the XGT network through XG5000 communication service. The XG5000 remote access is composed of 1-stage access and 2-stage access.

The below figure describes the remote 1-stage and 2-stage access methods.

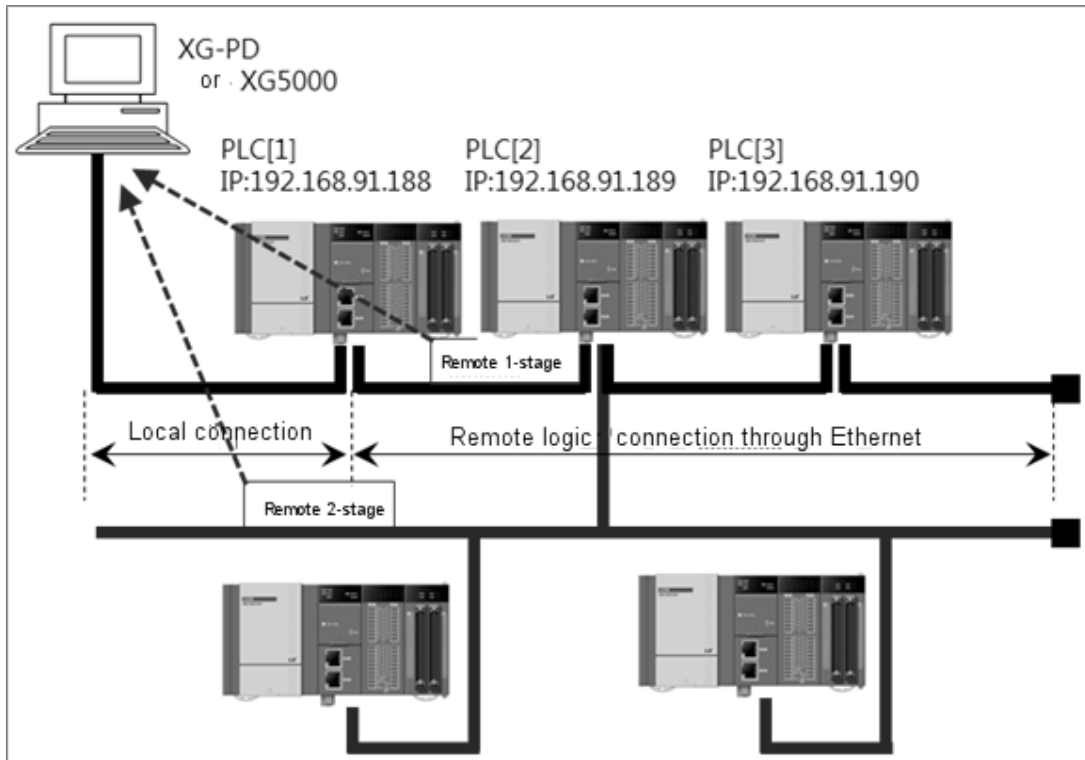

The above figure shows the example of 1-stage (PLC B) and 2-stage (PLC E) access in the system composed of two networks.

1) Direct and remote 1-stage access in the PC connected to Ethernet

If the PC where XG5000 is running is connected to the PLC through network, you can perform the remote 1-stage access through Ethernet without connecting RS-232C to the PLC's CPU.

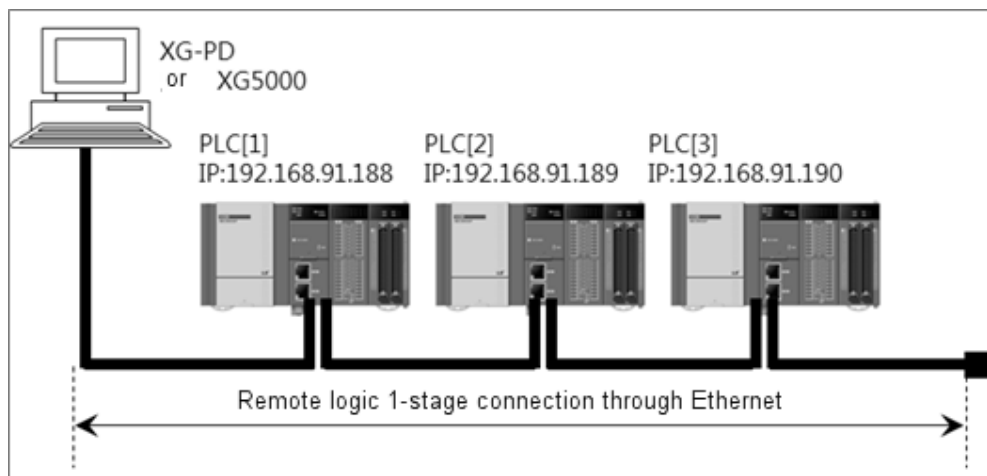

[Fig. 1.9.1] Remote 1-stage access system through the PC

[Fig. 1.9.1] shows the case that the PC and the PLC are connected through Ethernet. In this case, you

can access to all PLCs in the network. The local access is omitted and the remote 1-stage access is performed for all PLCs. You need to choose the connection options and change settings as shown in the below dialog box in order to the direct and remote 1-stage access through Ethernet.

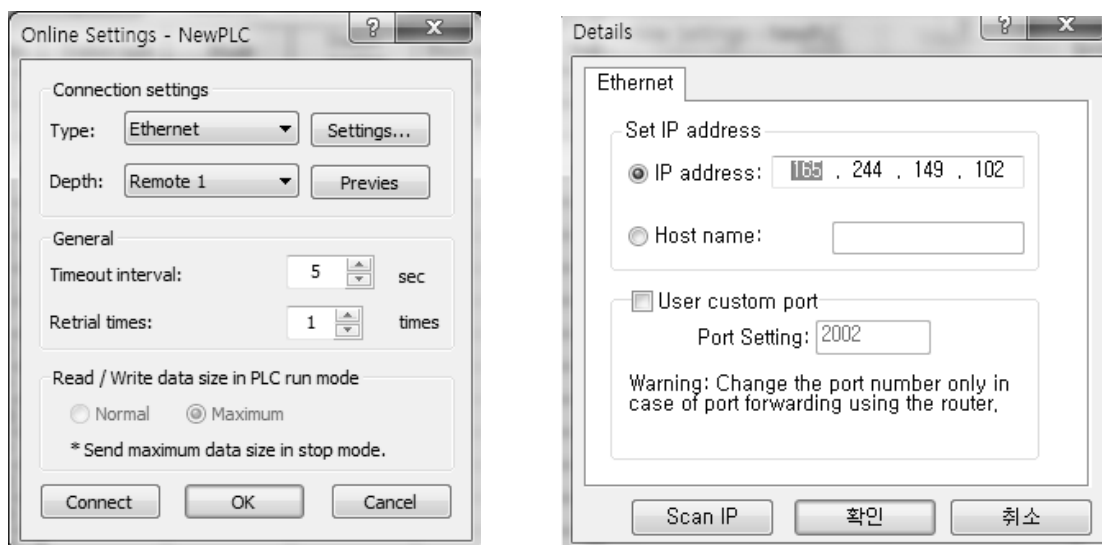

[Fig. 1.9.2] Direct and remote 1-stage access in the PC

(1) Access Method

You can select the access methods. In [Fig. 9.2.6], Ethernet is used for access instead of RS-232C so choose Ethernet.

(2) Access stage

You can determine to connect with the PLC through remote 1-stage or 2-stage. In this case, you need to choose 1-stage.

(3) IP address

Record the IP address of the FEnet I/F module to be accessed.

(4) All further processes are the same as the case using RS-232C.

Click the OK button and choose 'Access' in the online menu.

2) Direct and remote 2-stage access in the PC connected Ethernet

It is possible to realize the remote 2-stage access through Ethernet. The method is the same as the remote 1-stage and the example of setting access options is as below.

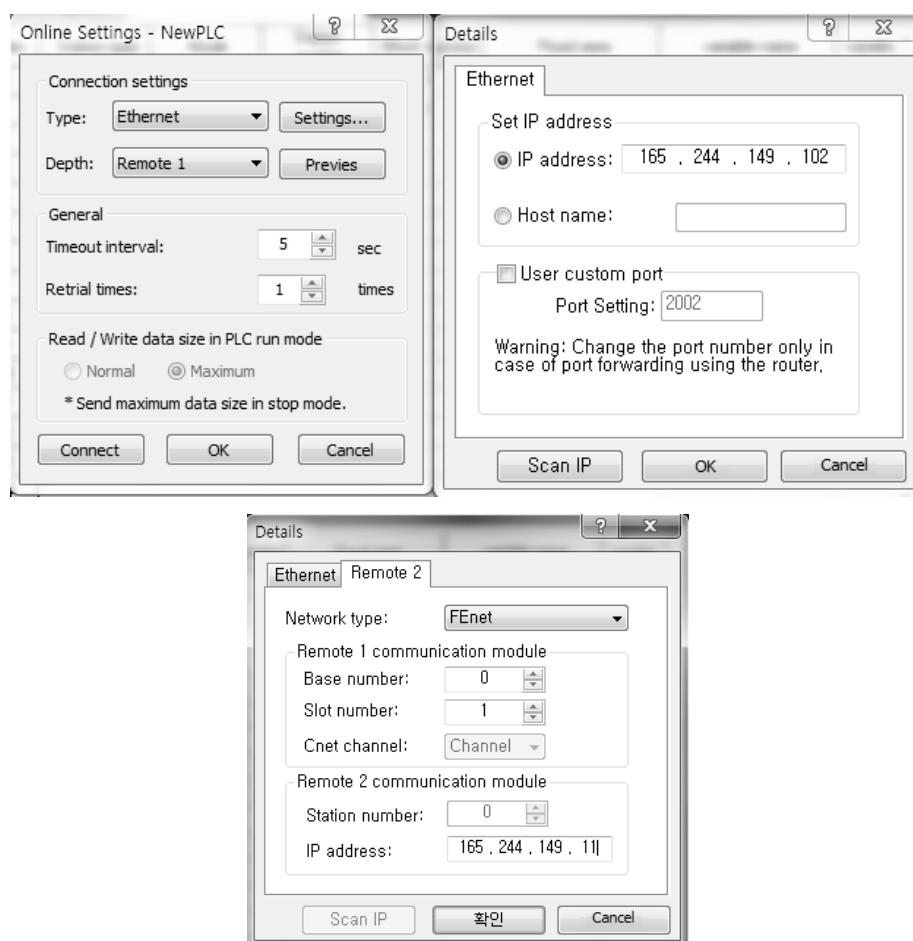

[Fig. 1.9.3] Direct and remote 2-stage access in the PC

Notice

Instructions for remote 1-stage/2-stage access

- (1) In case the currently open project in XG5000 is not matched with the accessed 1-stage and 2-stage CPU types, the following menu items are not available.
 - a) Write program and each parameter
 - b) Read program and each parameter
 - c) Monitor
 - d) Link Enable setting
 - e) I/O information
 - f) Forced I/O information
- (2) Open the project to be accessed and execute remote access when programming XG5000 through remote 1-stage and 2-stage access.
- (3) The remote access is supported up to 2-stage only and further remote access is not allowable.
- (4) In case of writing parameters after modifying communication parameters through remote access, the modified parameters will be applied only after disconnecting remote access.

1.10 File Transfer Protocol (FTP)

1.10.1 Outline

XGB-DN32U supports the Transfer Protocol (File Transfer Protocol) to download the data log file from a remote site through built-in Ethernet port. The File Transfer Protocol is TCP/IP based protocol to be designed for file transfer and you can manage files in a remote site by using the File Transfer Protocol. The File Transfer Protocol that is divided into the server and the client transmits or receives files as shown in [Fig. 1.10.1].

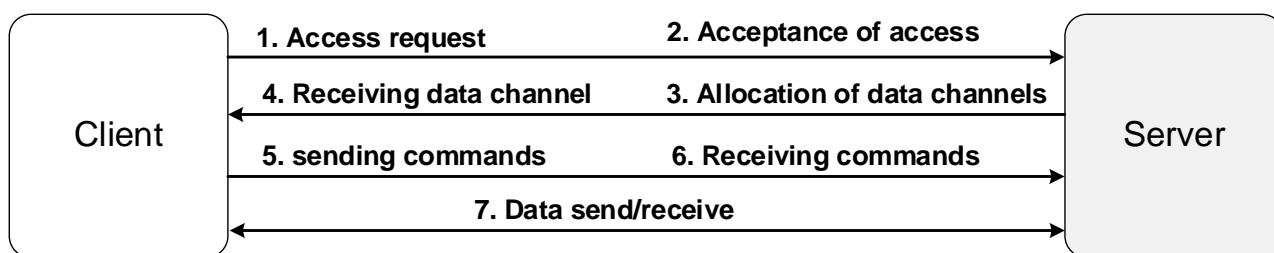

[Fig.1.10.1] FTP server/client structure

1.10.2 Supported Functions

You can access to XGB high-performance PLC series built-in FTP server through FTP client. After access, you can copy the data log file saved in the SD card to the user's PC where FTP client is installed or other devices. However, in terms of the FTP function, only the download function is provided to prevent arbitrary modification or changes of data log files through FTP.

1) Read File (file download)

It is the function to import and save files to the devices with FTP client or PC (Personal Computer) from XGBU's FTP server. The files are saved to the designated directory path of the devices with FTP client or PC.



1.10.3 Setting FTP server parameters

You need to set parameters through XG5000 to use the FTP server function.

- 1) Input the "TCP/IP setting" parameters in the window for setting FNet basic.
 - Input the IP address, subnet mask, gateway, DNS server address.
 - This address is commonly used for P2P service, high speed link service, remote service, FTP service.



[Fig. 1.10.2] Setting the basic FTP address

- 2) Check [Activate FTP server function] as shown in [Fig. 1.10.3].

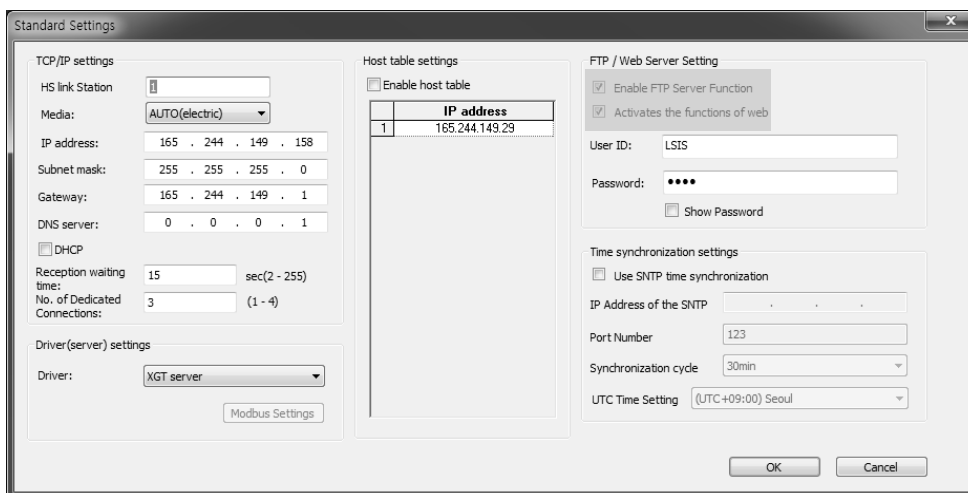

[Fig. 1.10.3] Activation of the FTP function

- 3) Enter the user ID and password to be used to access the FTP server.
 - You can change the user ID and password through XG5000 only.

Notice

Unless you set the user ID and password, basic ID and password will be set initially.

- **Basic setting ID:** LSUSER
- **Basic password:** 0000

4) Check 'Display Password' and verify whether the entered password is correct.



[Fig. 1.10.4] Viewing the password

5) If you press the OK button, setting the parameters to use FTP is completed.

6) When you execute [Online] → [Write Parameter], the parameters are written in the PLC.

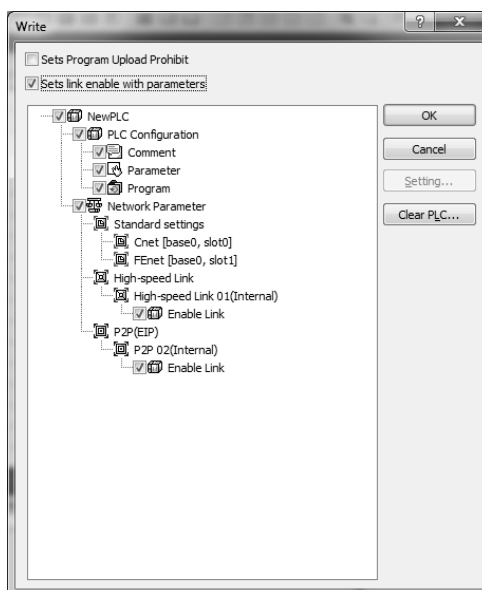

[Fig. 1.10.5] Writing parameters

Notice

- Rules for applying the user ID and password

You can enter the user ID and password that are composed of alphabetical characters and numbers but special characters are not available. They must be case-sensitive and must not exceed the maximum of 8 digits.

1.10.4 How to access to the FTP server

Just one user can access to the FTP server at a time so using Windows FTP client is recommended.

Notice

The compatibility with other commercial client programs other than Windows FTP client is not guaranteed.

1) How to use WINDOWS command prompt

(1) First of all, execute the command prompt in Windows

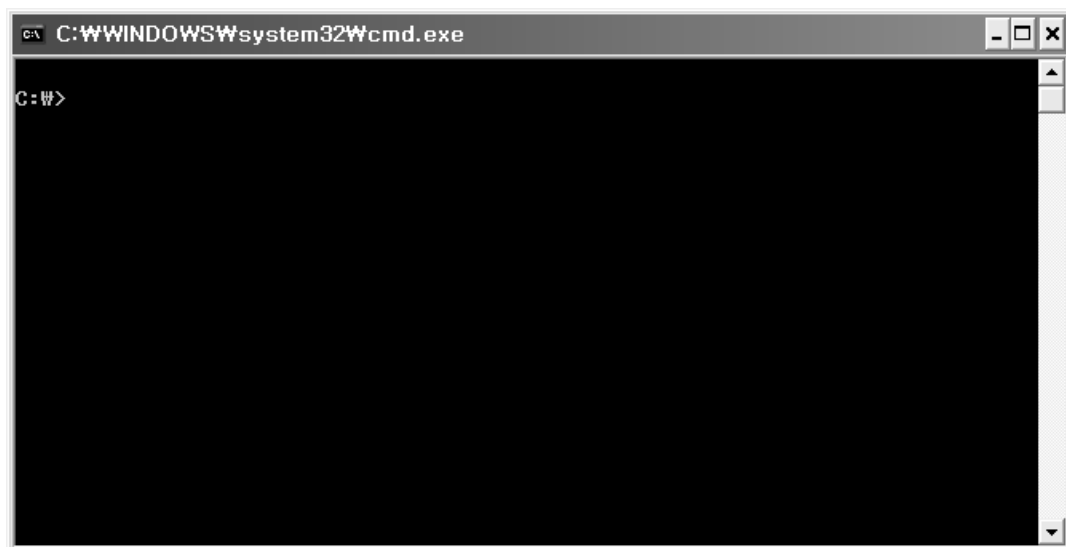
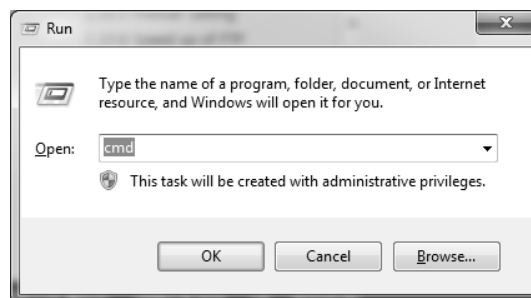

[Fig. 1.10.6] Execution of command prompt

Notice

To execute the command prompt window, enter 'cmd' to the window or press [Start]→[All Programs]→[Auxiliary Programs]→[Command Prompt]. For more details on execution of command prompt, refer to the Windows manual.

(2) Enter the FTP command in command prompt to start the FTP session.

No.	Used function
1	ftp

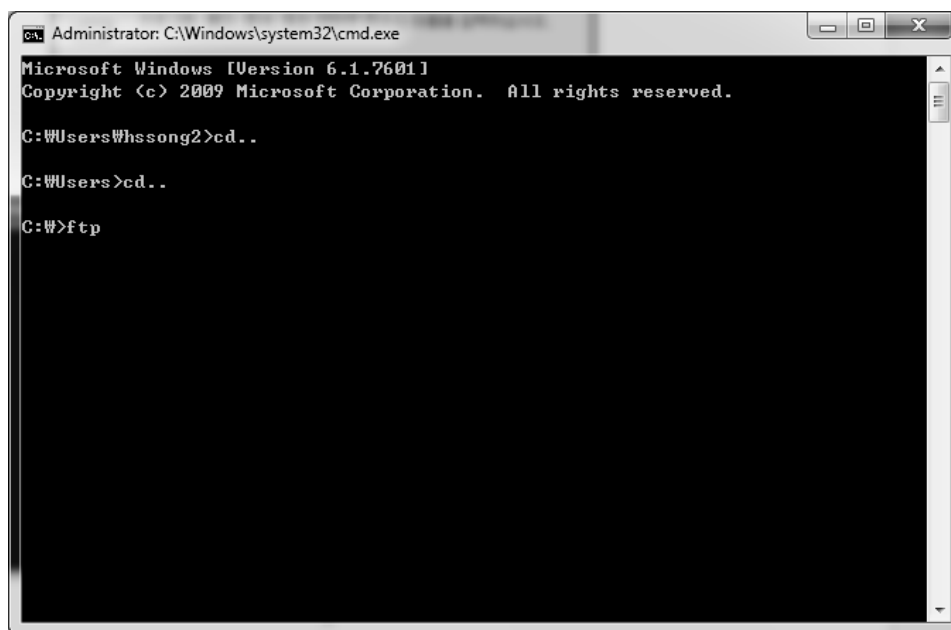

[Fig. 1.10.7] Startup of FTP

(3) Enter the 'open [IP address]' to access to the FTP server

- You can enter the FTP [IP address] in the command prompt instead of using the open command.

No.	Used function
1	Open 165.144.149.158

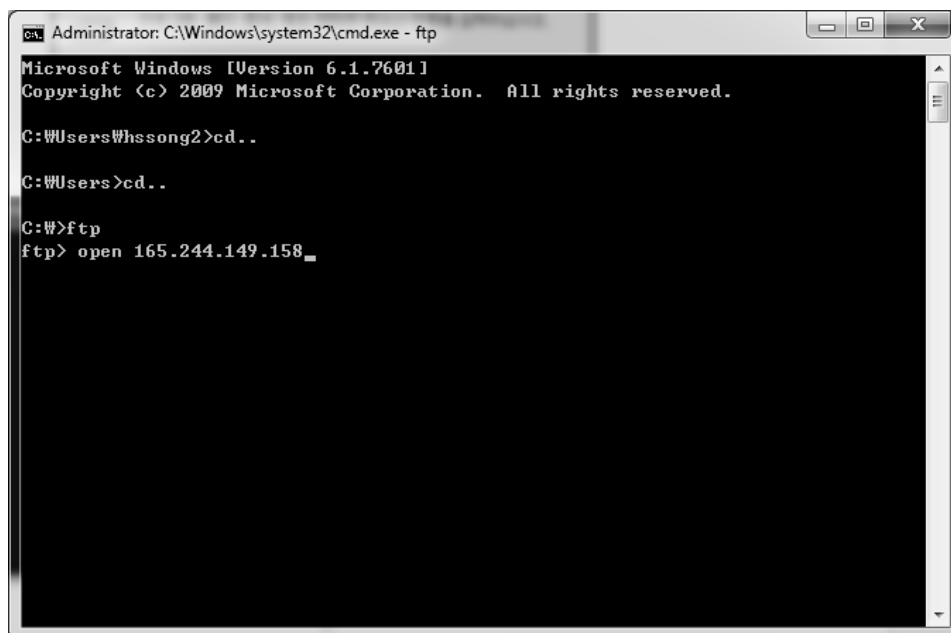

[Fig. 1.10.8] FTP server access using the open command

- (4) Enter the user ID and password to access to the FTP server.
- It is normal that the password is not displayed on the screen.

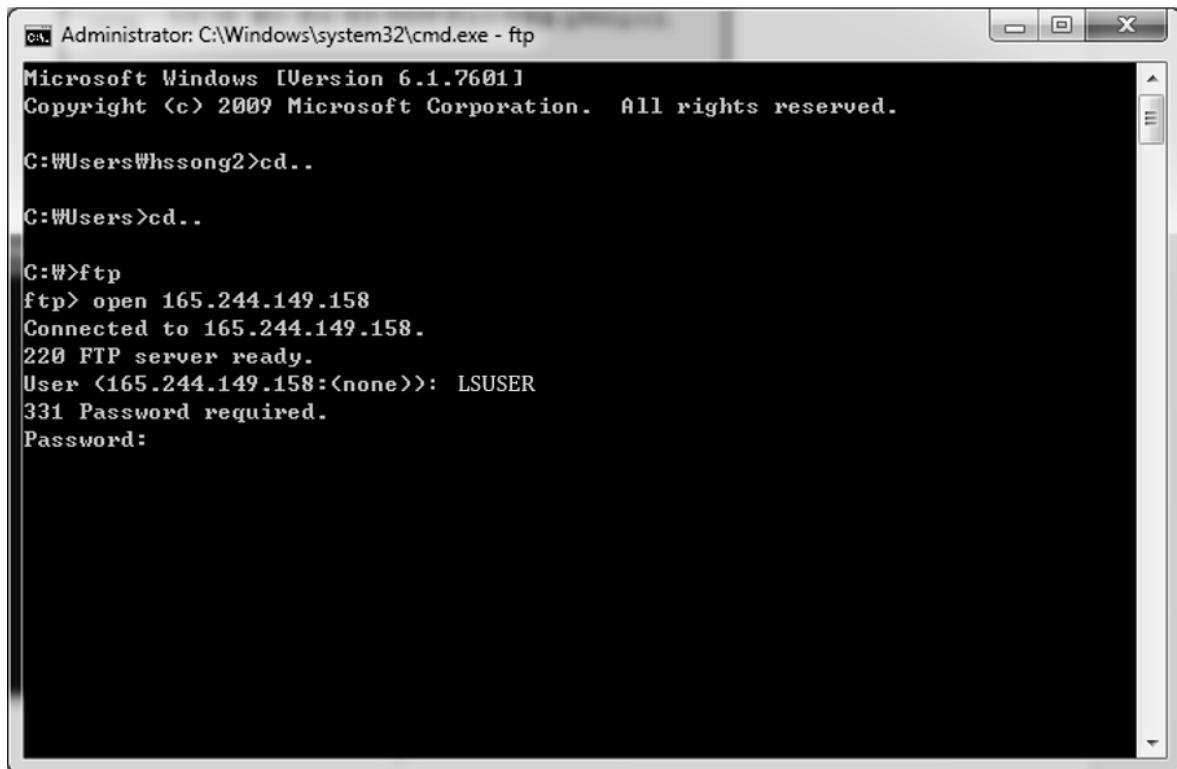

```
Administrator: C:\Windows\system32\cmd.exe - ftp
Microsoft Windows [Version 6.1.7601]
Copyright (c) 2009 Microsoft Corporation. All rights reserved.

C:\Users\whssong2>cd..

C:\Users>cd..

C:\>ftp
ftp> open 165.244.149.158
Connected to 165.244.149.158.
220 FTP server ready.
User (165.244.149.158:(none)): LSUSER
331 Password required.
Password:
```

[Fig. 1.10.9] ID authentication after accessing to the FTP server

(5) When login is completed successfully, the message will be displayed; “User name accepted.”

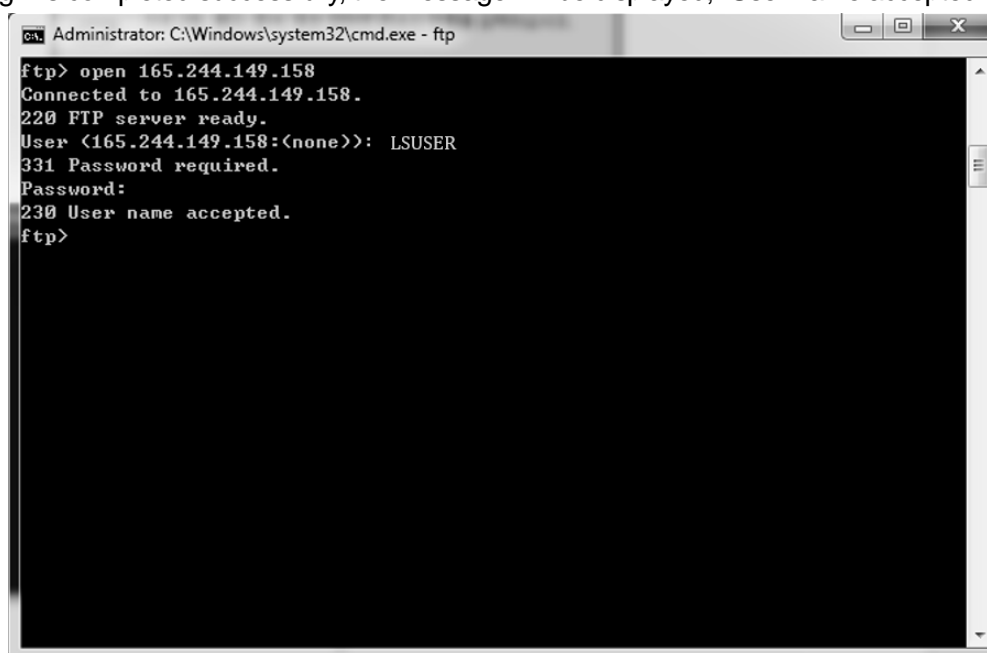

```
Administrator: C:\Windows\system32\cmd.exe - ftp
ftp> open 165.244.149.158
Connected to 165.244.149.158.
220 FTP server ready.
User <165.244.149.158:<none>>: LSUSER
331 Password required.
Password:
230 User name accepted.
ftp>
```

[Fig. 1.10.10] Completion of FTP server access and login

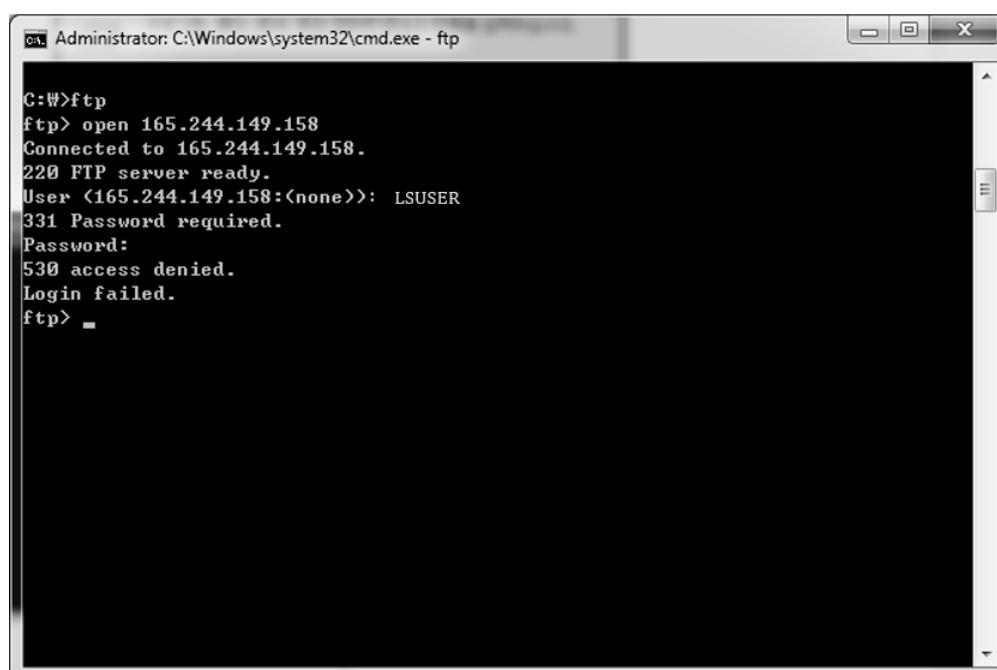

```
Administrator: C:\Windows\system32\cmd.exe - ftp
C:\W>ftp
ftp> open 165.244.149.158
Connected to 165.244.149.158.
220 FTP server ready.
User <165.244.149.158:<none>>: LSUSER
331 Password required.
Password:
530 access denied.
Login failed.
ftp> _
```

[Fig. 1.10.11] Failure of FTP server login

(6) In case you access to the FTP server through windows command prompts, you cannot see the progress status of file download. Accordingly, you can check the current progress of file download by activating the HASH function.

No.	Used function
1	hash

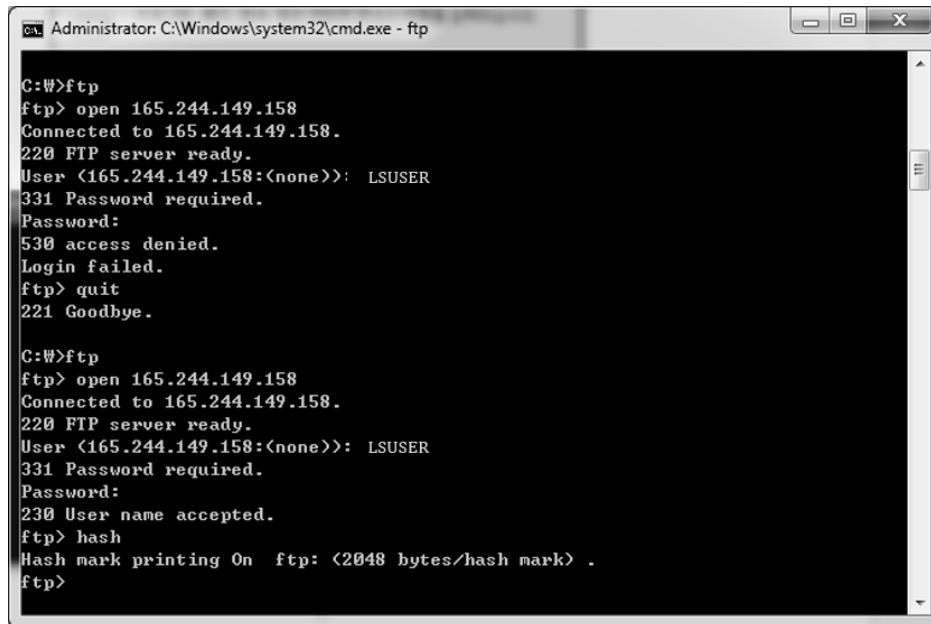

[Fig. 1.10.12] Activation of the HASH function

(7) You can view the directories and file lists that exist in the drive currently through the 'DIR' command.

No.	Used function
1	dir

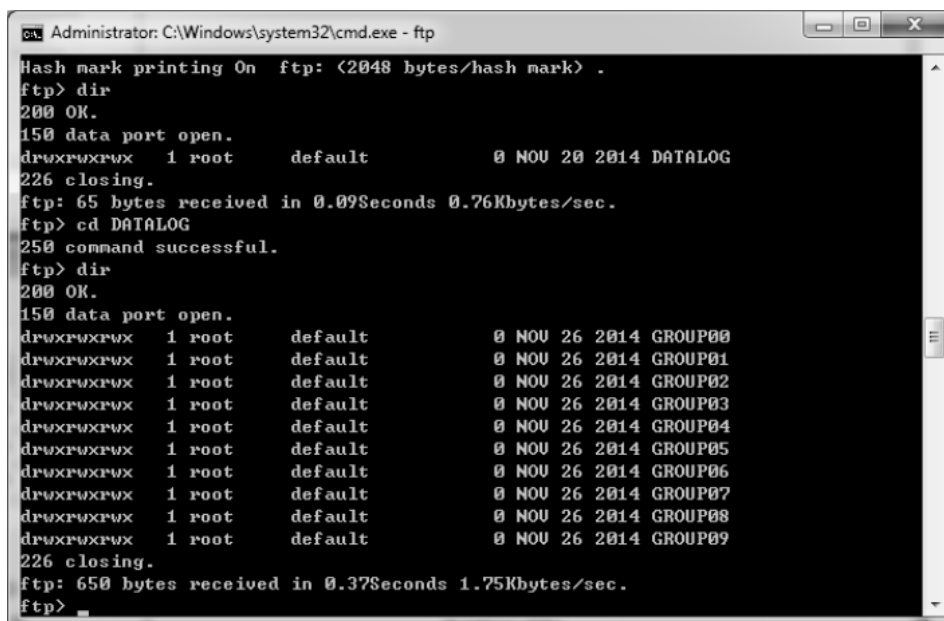

[Fig. 1.10.13] Viewing the file list of the current route through the 'dir' command

- (8) You can go into the lower folder through the 'cd [Folder name]'command. If you execute the 'DIR' command again after going into the lower folder, only the files ahasnd folder lists that exist in the lower folder will be displayed.

No.	Used function
1	cd DATALOG
2	dir
3	cd GROUP00
4	dir

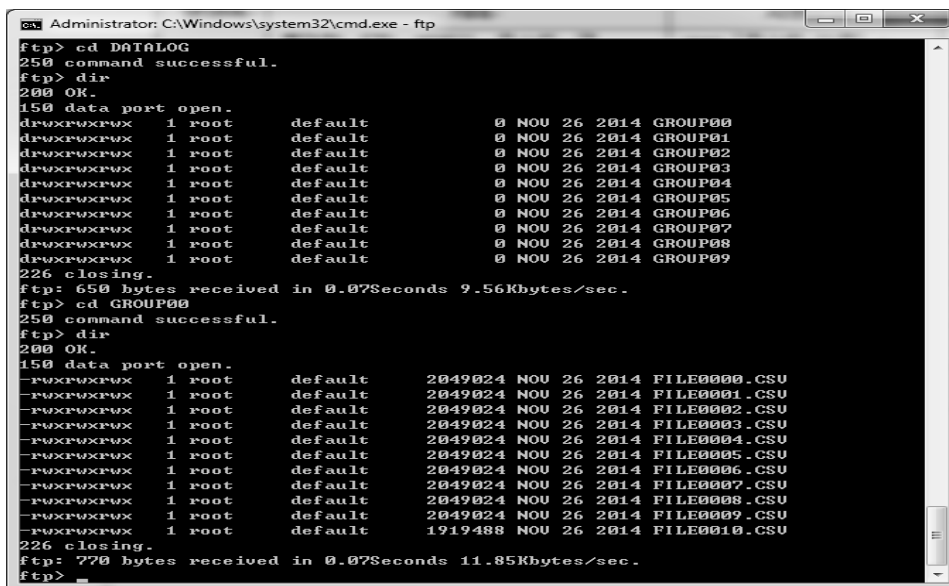

[Fig. 1.10.14] Entry into the lower folder through the 'cd' command

- (9) Designate the directory path of the FTP client side that will download the file through the 'lcd' command.

No.	Used function	Remark
1	lcd c:\test	'C:\test' folder is made before using lcd command

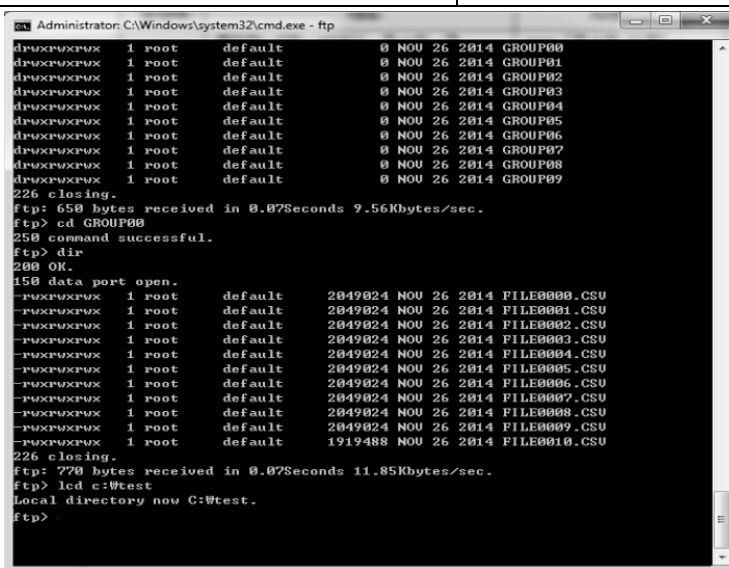

[Fig. 1.10.15] Activation of HASH function

2) FTP server command list

The windows FTP provides the below commands basically. You can check the further commands through '?' commands. There are also unserviceable functions to protect data log files so refer to the below list.

Commands	Operations	Commands	Operations
?	Displaying the available commands	trace	Setup/cancellation of packet trace
bye	Termination and end of the ftp session	type	Setting the file transfer type
cd	Changing remote working directory	user	Transmission of the new user information
close	Termination of the ftp session	verbose	Setup/cancellation of verbose mode
open	Connection to the remote ftp	quote	Sending random ftp commands
prompt	Executing interactive questions to multiple commands	recv	Receiving files
put	Sending one file (Not available)	dir	Enumerate the contents of remote directories
pwd	Printing the remote computer's working directory	disconnect	Termination of the ftp session
quit	Termination and end of the ftp session	get	Receiving files
lcd	Changing the local working directory	glob	Setup/cancellation of meta character extension of local file names
literal	Sending random ftp commands	hash	Setup/cancellation of '#' printing for the transmitted buffer
ls	Enumerate the contents of remote directories	help	Printing the local HELP information
status	Viewing the current status	cd ..	Moving to the upper directory

3) Command Usage

Commands	Description	Operations	Example
open	Attempting to access to the server by entering the specific FTP server's host name or IP.	open [host name]	open LSUSERHOST
		open [IP address]	open 166.0.1.254
dir	Showing the whole files saved to the basic unit's SD card with the file information	dir [drive volume:]	dir B:\
get	Reading the specific file from the basic unit's SD card	get [File path and file name to be read from the server]	get LSUSER.CSV
ls	Showing only the names of files saved the SD card of the basic unit	ls [drive volume:]	ls B:\
quit	Braking and disconnecting the FTP server and FTP session	quit	quit
bye	Braking and disconnecting the FTP server and FTP session	Bye	bye
cd ..	Moving to the upper directory from the current one.	cd ..	cd ..

Notice

- (1) You need to distinguish ASCII from Binary command depending on the file extension.
If you transmit the file with a wrong mode, the file will not work properly.
- (a) File extension names using ASCII: html, htm, txt, cgi, pl, php, phtml, php3, sql, c, ph, py, etc.
(b) File extension names using Binary: gif, jpg, swf, png, exe, asf, wmv, zip, rar, gzip, tar, gz, etc.
- (2) If you download the network setting parameters when accessing to the FTP server, the current download will stop and serious errors may occur in the relevant file so you cannot open it in the PC. Accordingly, if possible, you are recommended to disconnect the FTP server when downloading the network setting parameters.

4) FTP response code list

Response codes	Details
150	Opens the data transfer port successfully.
200	OK command
220	Ready to use the FTP server.
226	Closes the data transfer port after successful transmission.
230	Successful access to the FTP server through the entered ID and password.
250	The connection of requested files and folders is successfully completed.
257	Indicates the current remote directory's path
331	Server's request on the password
510	Unserviceable command

1.10.5 Firewall Setting

When you access to the FTP server through Windows command prompts, FTP access may not be smooth since the FTP access is applied. When you have bad access, cancel a firewall or apply exception handling. If the FTP access is not smooth, refer to the below.

1) Cancellation of a firewall

Clear the window's own firewall.

- 1) Execute the control panel.
- 2) Execute the Windows Firewall.
- 3) Execute setup or clear of the Windows Firewall.
- 4) Clear all firewalls as below.

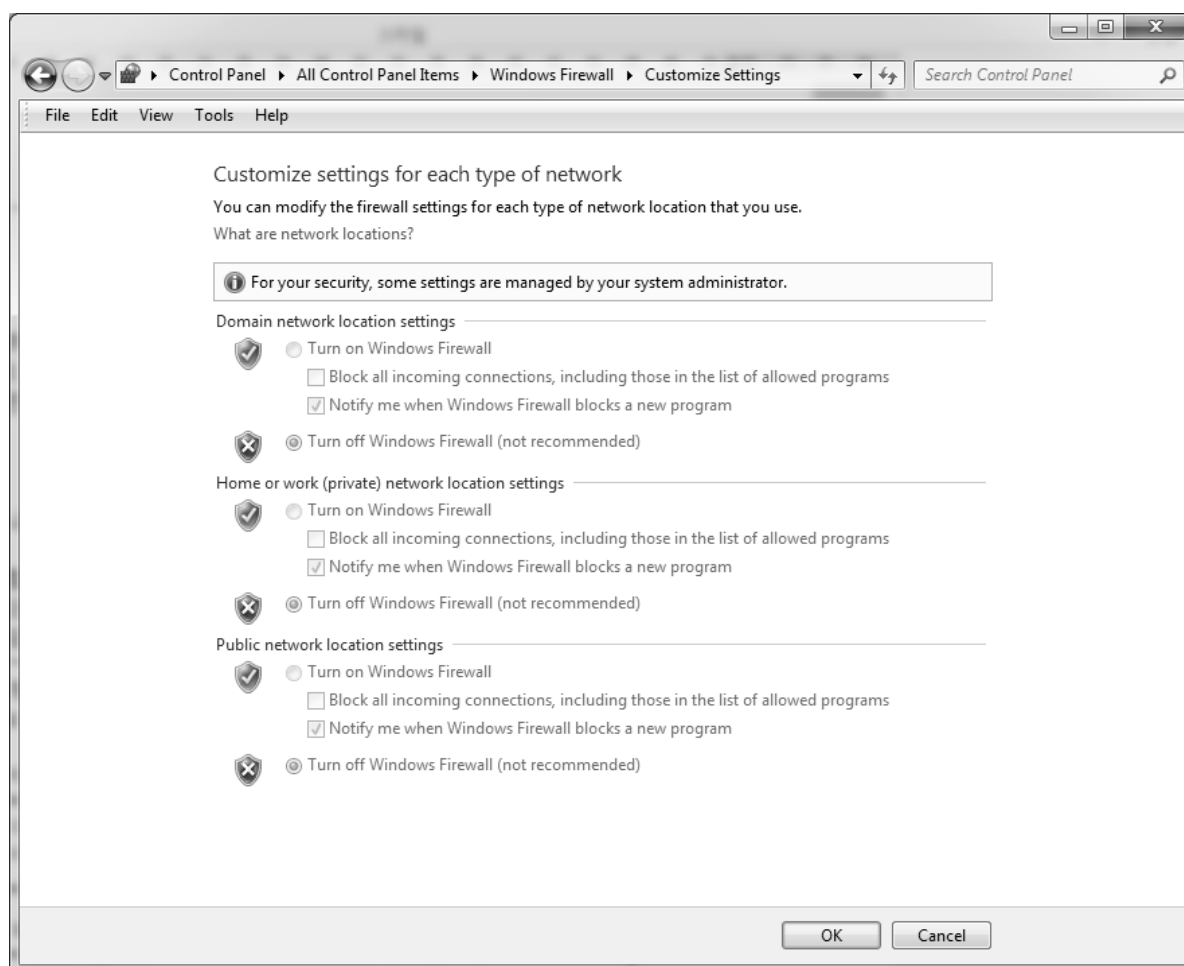

Notice

If you clear the Windows Firewall, you may be exposed to various external intrusions so you are recommended to register the exceptional rules to a firewall.

2) Registration of exceptional rules

You can refer to the following procedures to register exceptional rules to a firewall.

- 1) Execute the control panel.
- 2) Execute the Windows Firewall.
- 3) If you execute the advanced settings, the below screen will pop up.

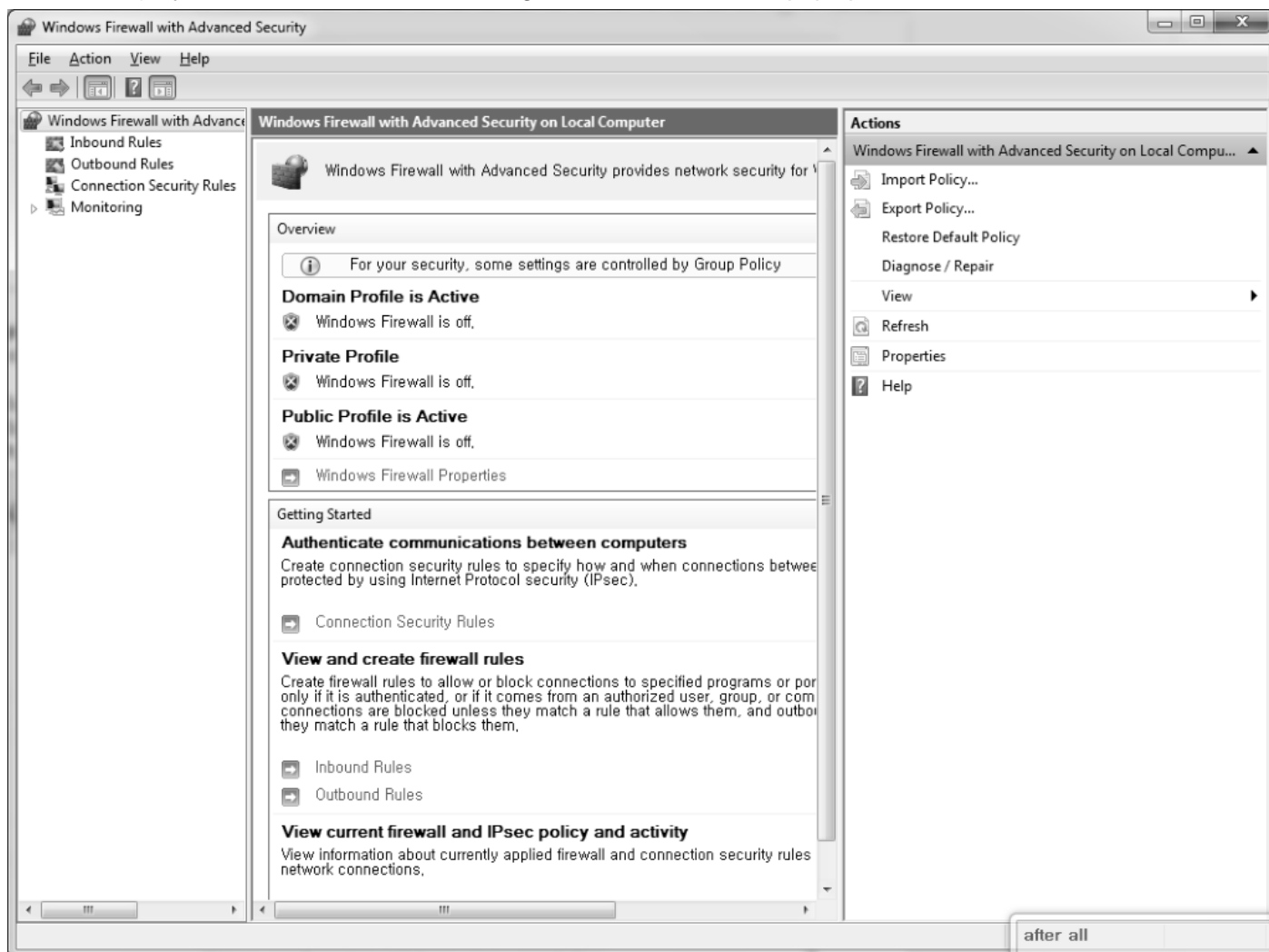

3) Choose the inbound rules.

4) Choose 'New Rules' at the top of the right side.

5) Create the rules with the method preferred by a user

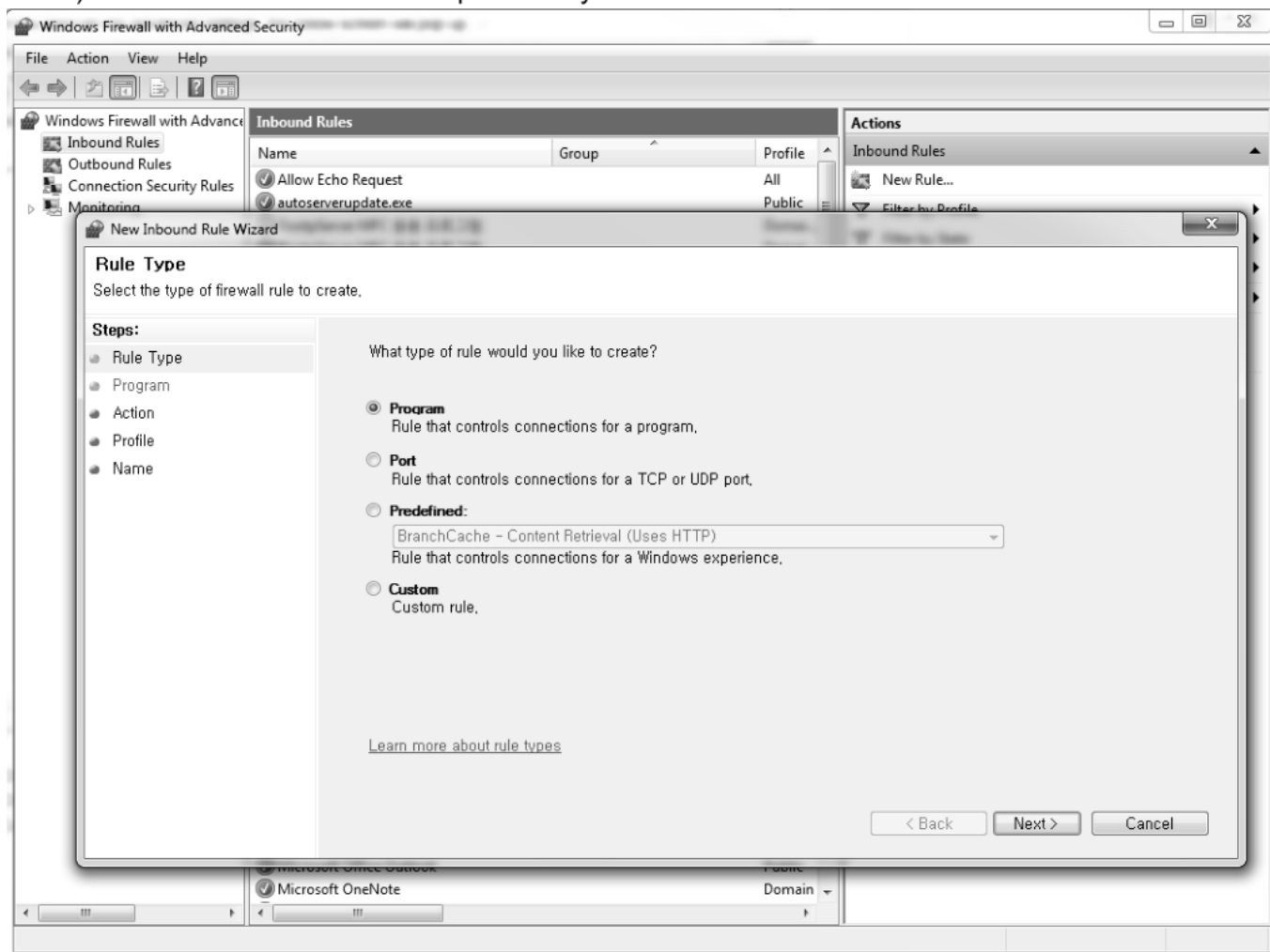

Notice
For registering exceptional rules, refer to the window manual.

1.10.6 Speed up of FTP

XGB-DN32U's built-in FTP server is supposed to send one data packet per one scan to minimize the influence on the scan time. In this structure, if the response to the transmitted data packet is not received immediately, the next packet will not be sent until the response is obtained. However, windows is usually supposed to send the response after waiting until 2 packets are received or after 20ms, instead of responding all when receiving the data packet. Accordingly, you are recommended to set that ACK is sent whenever the TCP/IP of windows receives one packet through a register as below.

- 1) Select the [Start] button of Windows for execution.(Shortcut key /Windows key + R)
- 2) Input 'regedit' to the execution window and run the process.

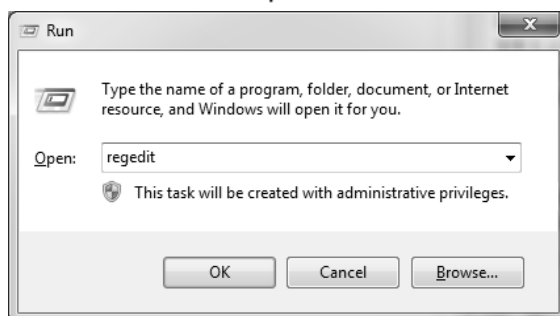

- 3) Check the below path.
 HKEY_LOCAL_MACHINE\SYSTEM\CurrentControlSet\services\Tcpip\Parameters\Interfaces
- 4) Depending on the devices installed in the PC, You can see the folders are created
- 5) If there are several register folders, select one by one and find the folder where the current PC's IP address is set in the right register value.

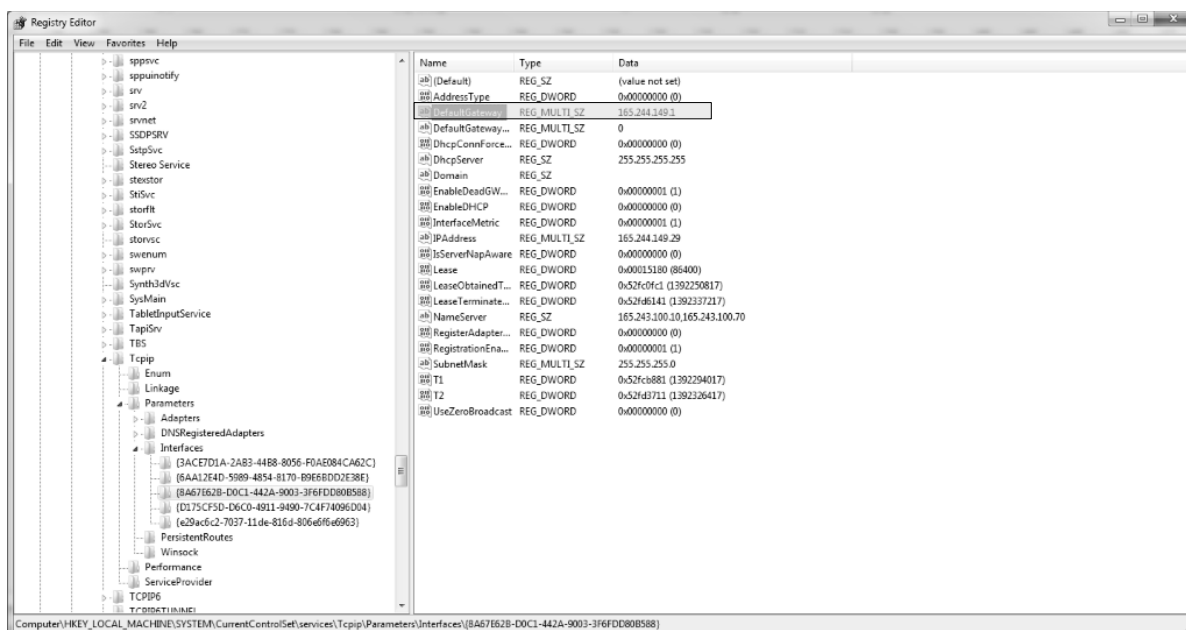

- 6) Click with the right mouse button on the right screen of the relevant folder and select New] →[DWORD(32bit) value].

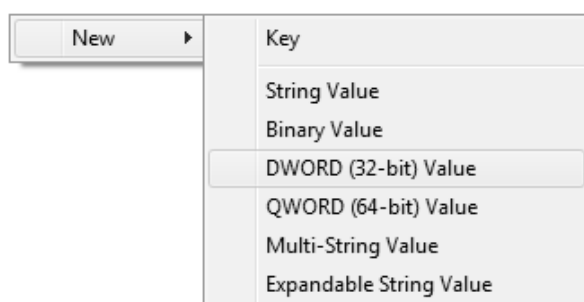

- 7) Enter the value name as shown below.
- Value name: TcpAckFrequency (It should be case-sensitive.)
- 8) Double-click the created register and enter 1 to the value data.

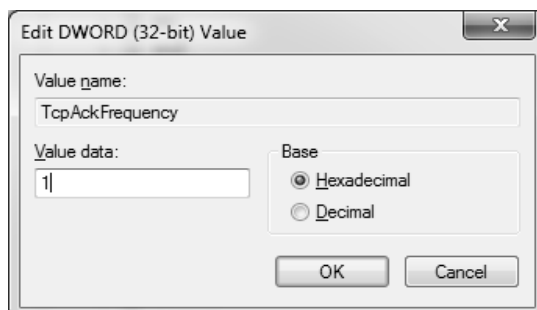

- 9) Reboot the computer.

1.11 E-mail Transfer(SMTP)

1.11.1 Outline of the Simple Mail Transfer Protocol(SMTP)

XGB high-performance module PLC supports the Simple Mail Transfer Protocol (SMTP). The SMTP is the protocol to send the E-mail on the Internet. The using TCP Port is No.25. In the SMTP that is the text-based protocol, not only request/response messages but also all characters should be 7 bit ACSII.

1) E-mail service

If the system has some problems, E-mail service is required to inform the administrator of the state remotely through the mail. When the CPU's state changes during operation or events occur, you can inform the administrator of the state through the mail server. The E-mail service is also available in common mails and you need to configure the separate relay server to send a common mail.

2) Configuration of the E-mail system

To use the common E-mail service, the configuration for using E-mail is needed. To transfer a common mail, you need to encrypt the mail for security but it is not easy for the PLC to treat this process so that is why you have to use the SMTP relay server. The SMTP relay server accesses to the common E-mail server by using the mail information transferred by the PLC and send the mail in place of the PLC. Therefore, as shown in [Fig. 11.1.1.1] E-mail transfer process, you can send the mail through the SMTP relay server.

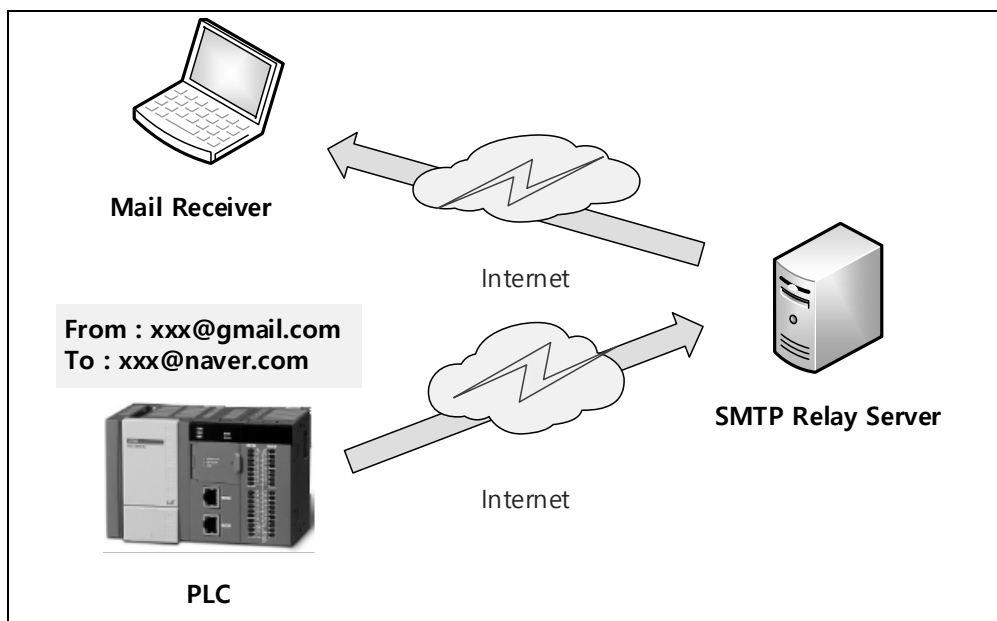

[Fig. 11.1.1.1] E-mail transfer process

3) Specifications of SMTP Realy server

Items	Specifications	Remarks
Maximum concurrent connection number	8	For some email account, because it limits the mail sent through the multi-connection, some mail(occurred simultaneously by the PLC using the same account server) may not be transmitted.

4) Flow Chart of E-mail transfer

The following is the flow chart of E-mail transfer. As shown in [Fig. 11.1.1.2] Flow chart of E-mail **transfer**, in order to transfer a mail, you need to install the SMTP relay server and set up E-mail parameters through XG5000 and meet the start-up conditions to send the mail. If the start-up conditions are met, the mail information is sent to the SMTP relay server and then, the SMTP relay server substitungly goes through authentication process and sends the final mail to a recipient. The mail recipient can see the ID and title, details of the E-mail set in XG5000.

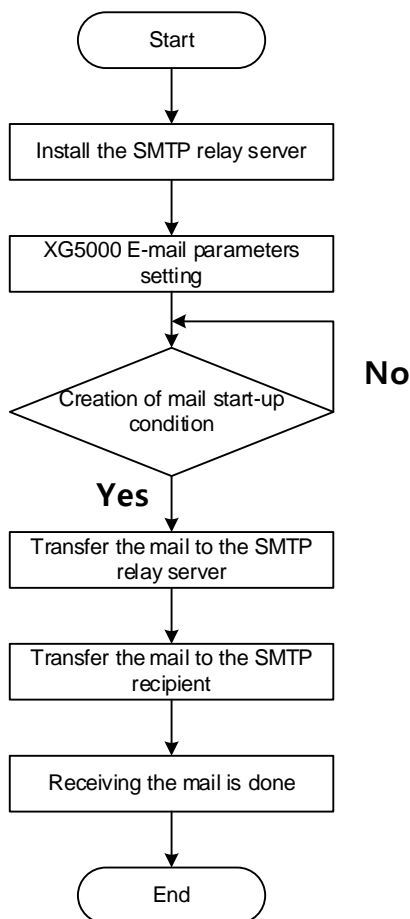

[Fig. 11.1.1.2] Flow Chart of E-mail transfer

Notice

- (1)The SMTP relay server and PLC should be connected to the Ethernet network. The SMTP relay server sends the mail to a recipient in place of the PLC.
- (2) For more details on setting, refer to 1.11.2 E-mail Setting.

1.11.2 E-mail Setting

In order to use the common E-mail function, you need to set up the E-mail parameters and relay server.

1) Relay server setting



You need to set up the SMTP relay server to use the common E-mail as shown below.

2) Relay server program download

In order to set up the relay server, first of all, you need to download the relay server program. You can download the relay server program from LS ELECTRIC's website – Customer Support – Download Materials (SMTP relay server).

- Korean website: <https://www.ls-electric.com/ko/download/>
- English website: <https://www.ls-electric.com/support/download-center>

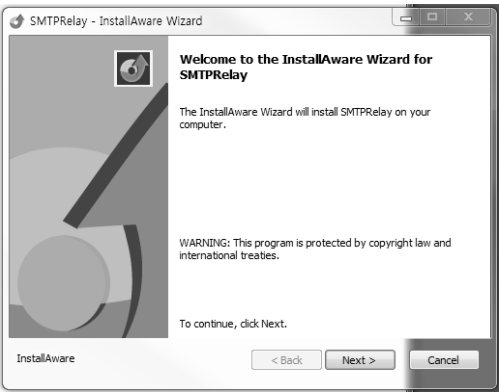
(1) Installaiton of the relay server

Procedures	Description	
1	Program execution	 <ol style="list-style-type: none"> 1) After downloading the program to set up the SMTP relay to the PC where you want to configure the relay server, double-click SMTPRelay.msi. 2) After clicking the Next button in the SMTP Relay window, if you select the remaining processes properly and click the Finish button, installation will be done.
2	SMTP relay server operations	 <ol style="list-style-type: none"> 1) If you double-click the 'SMTPRelayServer' icon on the desktop, the program will run as shown in the SMTP Relay server window.

(2) Setting to use the relay server

After installing the relay server, you need to register the relay server program in Windows as show below.

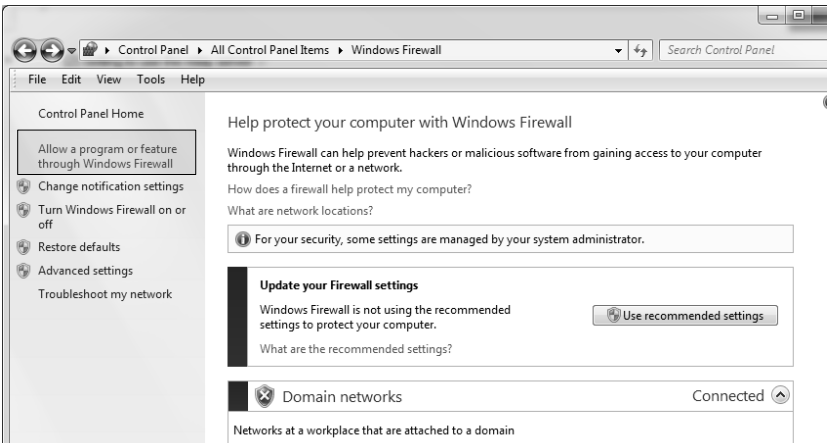
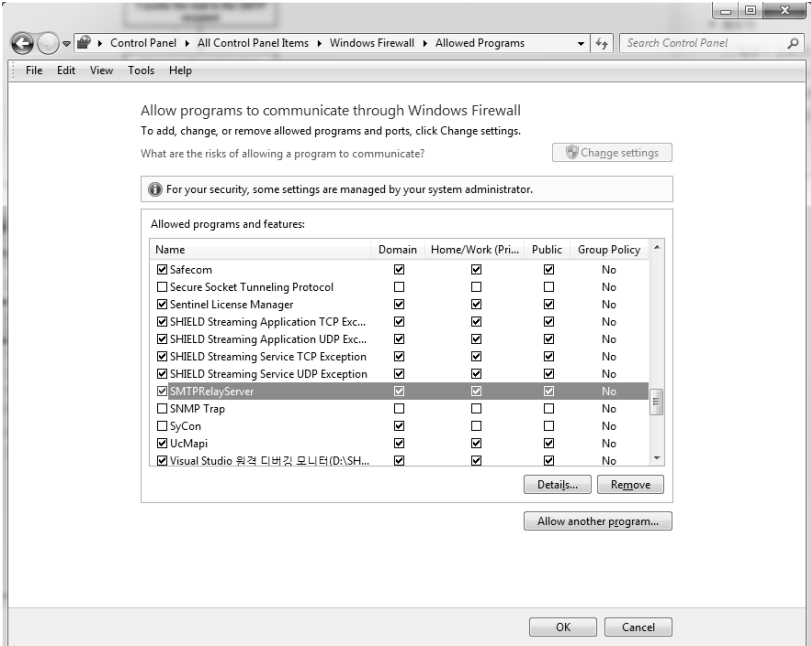
Procedures	Description	
1	Firewall setting	
<p>1) Click Windows – Control Panel – Windows firewall. 2) Through 'Windows Firewall' in the upper-left of the Windows firewall setting screen, click the Program or Firewall Enable.</p>		
2	Firewall Enable	
<p>Find the program called 'SMTPRelayServer' and check all items of domain, home/company(individual), common areas and then, click the 'OK' button.</p>		

Notice

(1) After the SMTP relay server setting is completed, in the E-mail setting window of 1.11.2 E-mail Setting, you need to input the IP address of the current PC for the IP address of the SMTP relay server information.

3) E-mail setting of the P2P service

You can use the E-mail function of the P2P service as shown below.

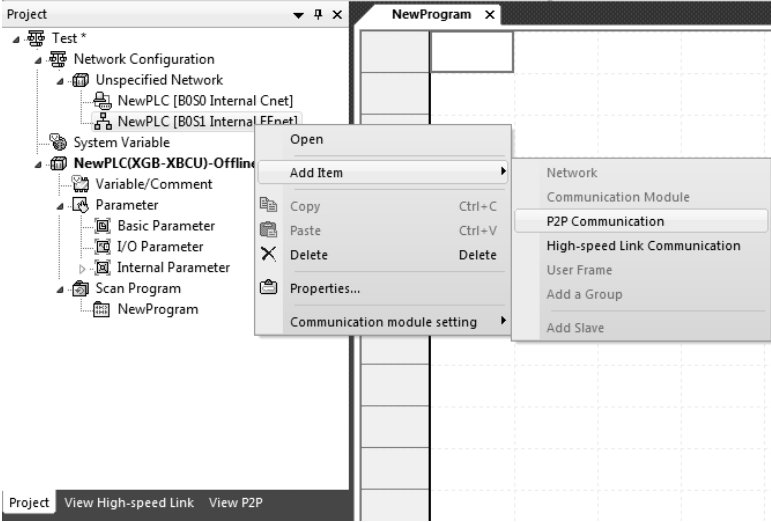
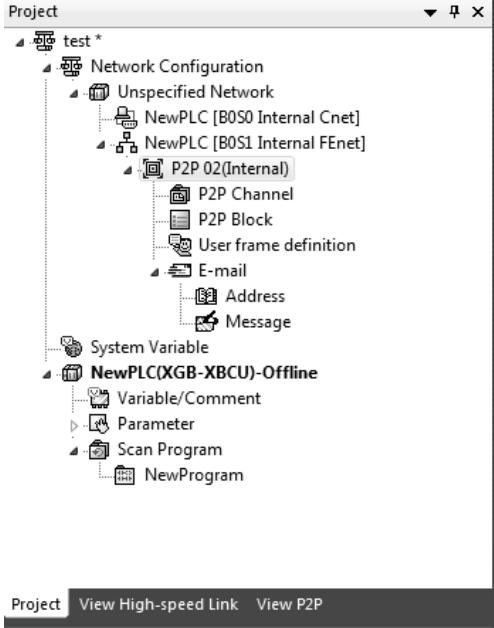
Procedures	Description	
<p>1</p> <p>Add P2P</p>		
<p>After selecting [Embedded FEnet] in XG5000's project window, click on the right mouse button and then, select [Add Items] → [P2P communication].</p>		
<p>2</p> <p>Creation of P2P</p>		
<p>When the P2P selection window is created, after selecting No.2 slot, click the 'OK' button.</p>		

Notice

(1) In the P2P view tab, E-mail can be set up in the same way.

Procedures	Description	
3	E-mail setting	
		<ol style="list-style-type: none"> 1) Double-click 'E-mail' in the P2P setting project window. 2) Set up the values referring to each E-mail's set value. 3) After setting parameters in the E-mail setting window, click the 'OK' button.

E-mail setting values

Item	Description
Using E-mail	It determines whether using the E-mail service or now. To start the E-mail service, you need to check this item.
Using SMTP relay server	To send the mail to the common mail server, you need to check the SMTP relay server item.
User information	User name It sets up the user name displayed when the other part received the mail. If you set up the user name with the PLC, the sender name will be displayed as the PLC.
	Mail address It is the recipient's mail address when pressing 'Reply'. It indicates the transmitting mail server composed of the user name and mail server. You can also set up that the PLC sends data and a normal PC receives the reply.
SMTP relay server information	IP address When checking the SMTP relay server item, you can fill in this. Enter the IP address to relay.
	Port Number You can input the port No. of the relay server. The port is No.25.
SMTP server information	SMTP server address It means the SMTP server's address. For example, Gmail's SMTP server address is 'smtp.gmail.com'.
	Port number It means the SMTP server's port No. Gmail uses No.465.
	Account name You can input the registered account name to the SMTP server.
	Password You can input the password of the registered account to the SMTP server.

The below table provides the address and port No of the common SMTP server. Input the address and port No. of the desired server to the SMTP server information.

SMTP server	SMTP server address	Port No.
Google	smtp.gmail.com	465
yahoo	smtp.mail.yahoo.com	25

The event information monitors the CPU's state periodically and keeps track of the state information. In case the PLC stops or errors occur, communication parameter does not work so in preparation for such a situation, the optional service is provided.

Item		Description
Event information	Message monitoring cycle	It should be set as 10 seconds or more. It is the time to check whether the PLC's mode has been changed.
	RUN => STOP	It is the option that the embedded Ethernet sends the E-mail by itself when the PLC's mode changes from RUN into STOP.
	STOP => RUN	It is the option that the embedded Ethernet sends the E-mail by itself when the PLC's mode changes from STOP into RUN.
	ERROR	It is the option that the embedded Ethernet sends the E-mail by itself when some errors occur in the PLC.

Notice

(1) When sending the mail through the SMTP relay server, there may be the common E-mail server that can send the mail only when the SMTP server information's 'SMTP server address' and 'account name' are matched with the user information's 'mail address'. Accordingly, check the mail server's policy and input the user information's 'mail address' based on the policy.

(2) The account name and password of the SMTP server information should be registered in the SMTP server. If you do not have any account, please register the account in the mail server for use.

(3) For more details on the address and message No. of the event information, refer to (1) Writing an address book and (3) Writing message.

(1) Writing an address book

You can write the recipient's mail address used for the E-mail service as shown below.

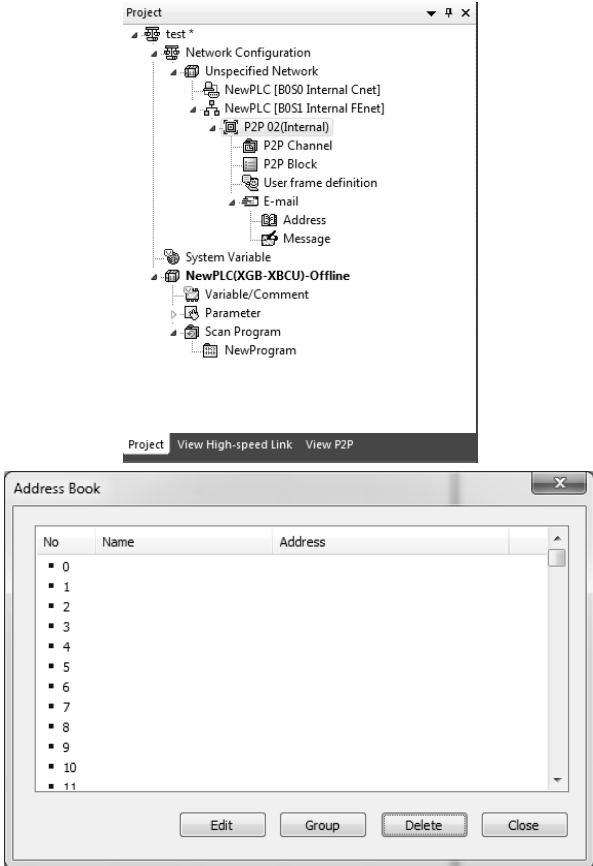
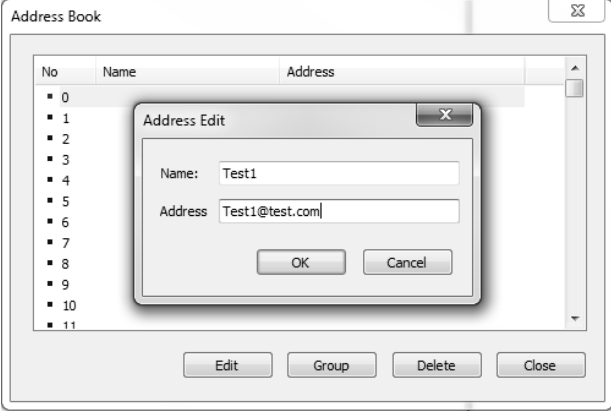
Procedures	Description	
1	Create the address book	 <p>The screenshot shows a project window with a tree view. The 'Address' item under 'E-mail' is selected. Below it, the 'Address Book' dialog box is open, displaying a table with columns 'No', 'Name', and 'Address'. The table has 12 rows, numbered 0 to 11. Buttons for 'Edit', 'Group', 'Delete', and 'Close' are at the bottom.</p>
<p>After selecting [Embedded FEnet] in XG5000's project window, double-click the address of [P2P 02(embedded)] or double-click the address of P2P No.2 in [P2P View].</p>		
2	Register the address	 <p>The screenshot shows the 'Address Edit' dialog box overlaid on the 'Address Book' dialog. The 'Address Edit' dialog has two input fields: 'Name' with the value 'Test1' and 'Address' with the value 'Test1@test.com'. There are 'OK' and 'Cancel' buttons at the bottom.</p>
<p>In the window for setting E-mail address book, register the address to which you want to send the mail. If you select 'Edit'. The address edition window will pop up. If you enter the name and mail address in this screen and select the OK button, registration of the address will be done.</p>		

(2) Registration of group address

If you want to send the mail not to individual but to the group, you can set up the group address as shown below.

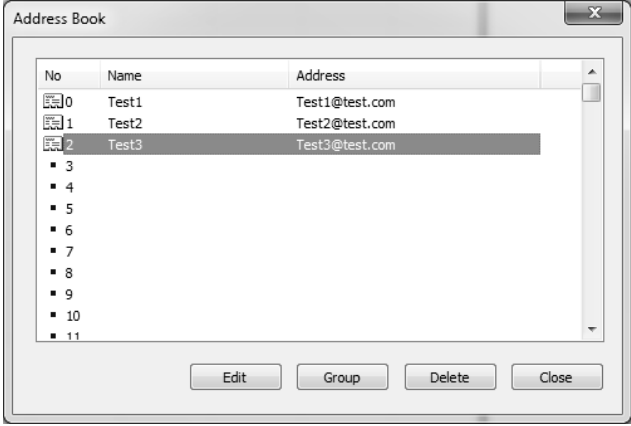
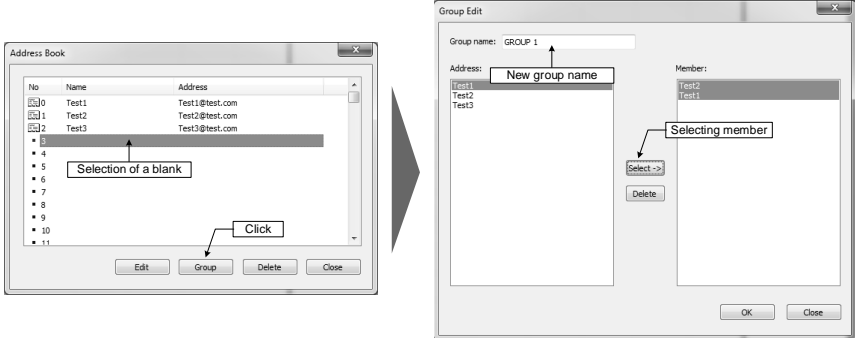
Procedures	Description	
1	Create group	 <p style="text-align: center;"><Address book></p>
1) Double-click the address of P2P No.2.		
2	Register group	
<p>After selecting to a blank of [Address book], select [Address book]- [group], the edition window for E-mail address book's group will be created. The details of the group edition window are as shown below.</p> <ol style="list-style-type: none"> 1) Group name: Name of the group to create newly 2) Contact information: Currently registered addresses 3) Members: Addresses to be included to the group 4) Select: It adds the addresses selected from the Contact Information to the Members. 5) Delete: It deletes the addresses selected in the Members from the Group. <p>After selecting the addresses to add to the group in the Contact Information, if you click [Select], you can see the addresses are added to the Members.</p>		

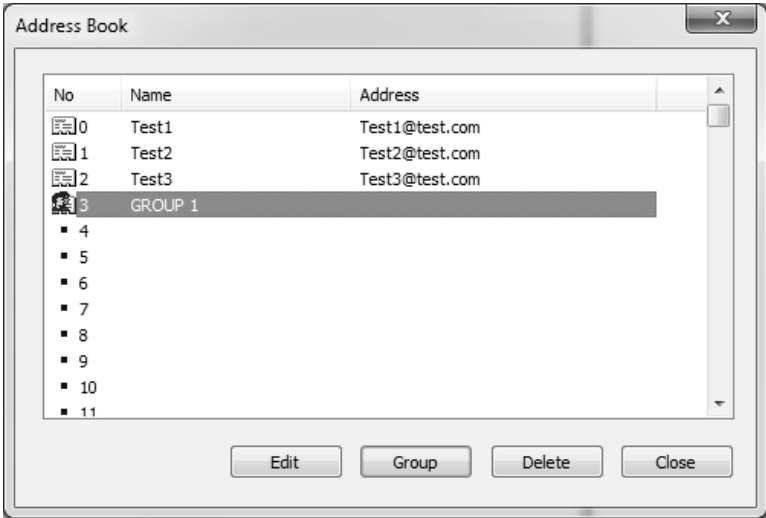
Procedures	Description	
3	Confirm creation of the group	
<p>If you click the OK button in [Group Edition], the group list added newly to the address book will be displayed with the individual addresses.</p>		

(3) Writing the message

You can write the mail message used for the E-mail service as shown below.

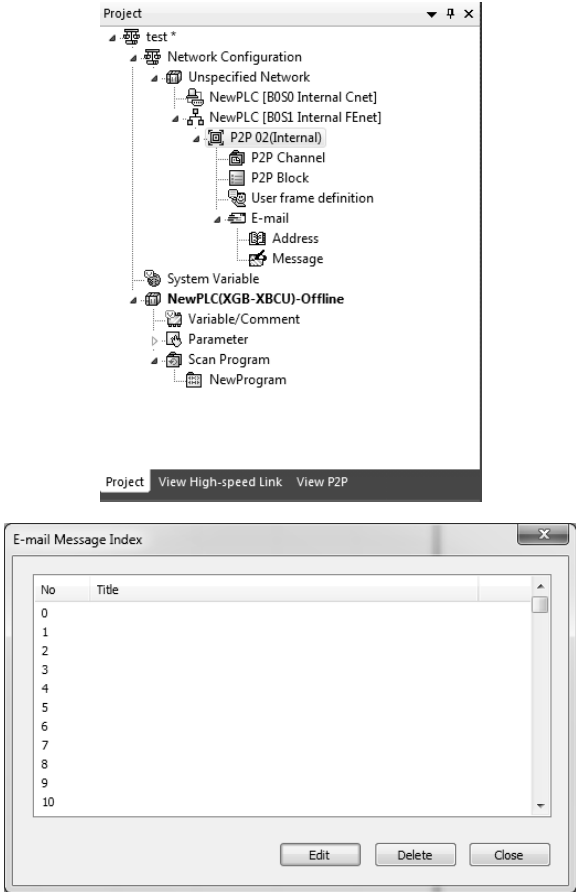
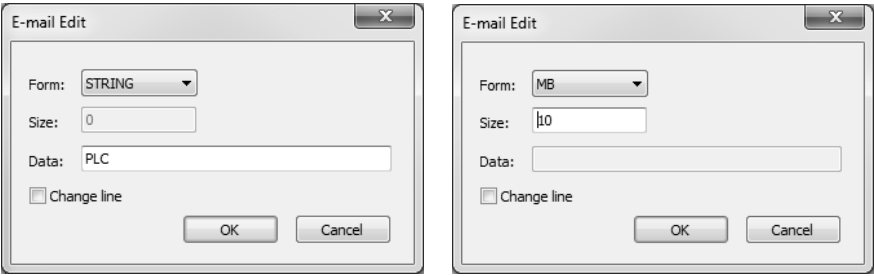
Procedures	Description	
1	Create the message list	 <p>1) After selecting [Embedded FEnet] in XG5000's project window, double-click the message of [P2P 02(embedded)] or double-click the message of P2P No.2 in [P2P View].</p>
2	Write messages	 <p>Click the 'Add' button in the E-mail message editing window and input the details to send. The configuration and details of E-mail edition are as shown below.</p> <ol style="list-style-type: none"> 1) Format: Selection of the message type <ul style="list-style-type: none"> - STRING: Selected when the transferred message is a string type - MB: Selected when the transferred message is a device type 2) Size: It is activated only when the format is [MB]. It means the size of Byte. 3) Data: It is activated only when the format is [STRING]. You can input the test to send. 4) Line break: Means the break of a message line.

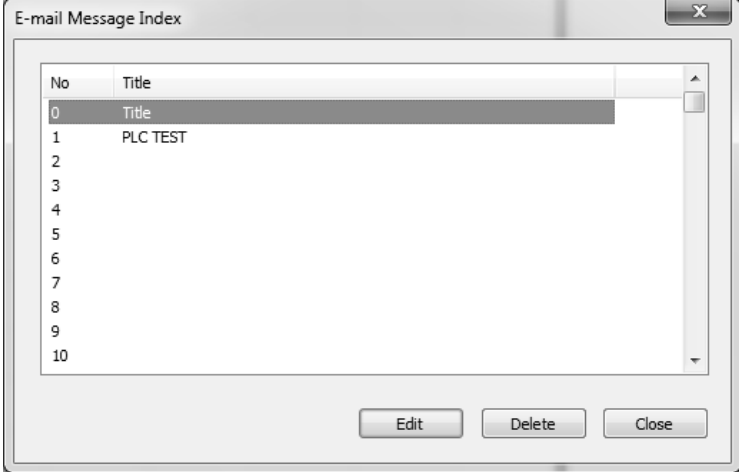
Procedures	Description																									
3	Confirm creation of messages	 <p>The screenshot shows a window titled "E-mail Message Index" with a close button (X) in the top right corner. Inside the window is a table with two columns: "No" and "Title". The table contains the following data:</p> <table border="1"> <thead> <tr> <th>No</th> <th>Title</th> </tr> </thead> <tbody> <tr> <td>0</td> <td>Title</td> </tr> <tr> <td>1</td> <td>PLC TEST</td> </tr> <tr> <td>2</td> <td></td> </tr> <tr> <td>3</td> <td></td> </tr> <tr> <td>4</td> <td></td> </tr> <tr> <td>5</td> <td></td> </tr> <tr> <td>6</td> <td></td> </tr> <tr> <td>7</td> <td></td> </tr> <tr> <td>8</td> <td></td> </tr> <tr> <td>9</td> <td></td> </tr> <tr> <td>10</td> <td></td> </tr> </tbody> </table> <p>At the bottom of the window, there are three buttons: "Edit", "Delete", and "Close".</p>	No	Title	0	Title	1	PLC TEST	2		3		4		5		6		7		8		9		10	
No	Title																									
0	Title																									
1	PLC TEST																									
2																										
3																										
4																										
5																										
6																										
7																										
8																										
9																										
10																										
<p>When the creation of the message is complete, the title will be added to the list of e-mail messages index.</p>																										

Notice

(1) The format of an E-mail message can be divided into String and Byte data received from the CPU. The MB type is used to send the P2P ESend parameter's message data as many as the number of bytes set in the Size.

(2) The line break includes the command to write on the next line when outputting the message in the received screen.

(4) P2P block setting

For the actual E-mail service, you can create the mail address book and message written above in the P2P block as shown below.

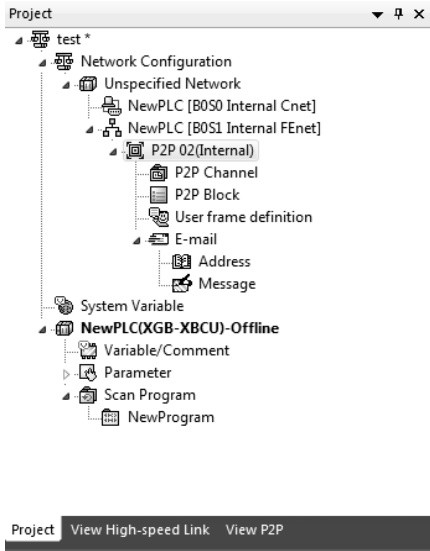
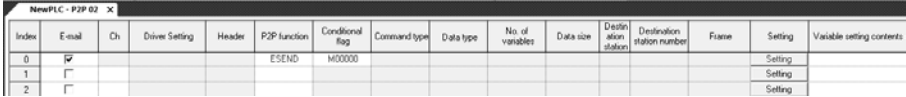
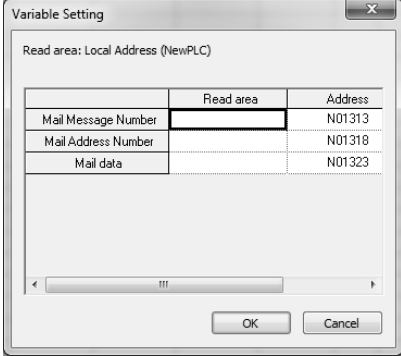
Procedures	Description	
1	P2P block	
<p>After selecting [Embedded FEnet] in XG5000's project window, double-click [P2P block] of [P2P 02(embedded)] or double-click [P2P block] of P2P No.2 in [P2P View].</p>		
2	Make P2P block	
<p>1) In the P2P parameter setting window, tick the [E-mail] checkbox. 2) Select [ESEND] in P2P functions. 3) Set up the start-up conditions to transfer E-mail.</p>		
3	Setting	
<p>Click the setting button to set up each variable. For more details, refer to 'E-mail variables'</p>		
4	<p>If you click the [OK] button, the parameter settings to transfer E-mail will be done.</p>	

The details of E-mail variables are as shown below.

Item		Description	
E-mail		It enables you to use the E-mail service.	
P2P function	ESEND	It sends the E-mail.	
	ERECEIVE	It receives the E-mail.	
Setting	Transmission	Mail message No.	Enter the index No. of the message list among E-mail settings of P2P and determine the mail tile and data.
		Mail address No.	Establish the registration No. set in the address book and decide to whom. * If you want to send the mail to several people, you can set up grouping. In this case, the recipient's mail address should be input in advance before grouping. The maximum number of groupings is limited to 10EA or less.
		Mail data	It means the start address of the data to send. In terms of the size of the transmitted data, starting with the first part, the mail is transmitted as many as the number of arrays corresponding to MB[10] among E-mail message settings.
	Reception	Mail information	It is the area where the mail information is saved.
		Mail message	It saves the received mail message to the PLC memory.

Notice

(1) The receiving pare is not supported in settings.

(5) Writing parameters

After parameter setting for the E-mail service is completed, you can apply the parameters to the PLC as show below.

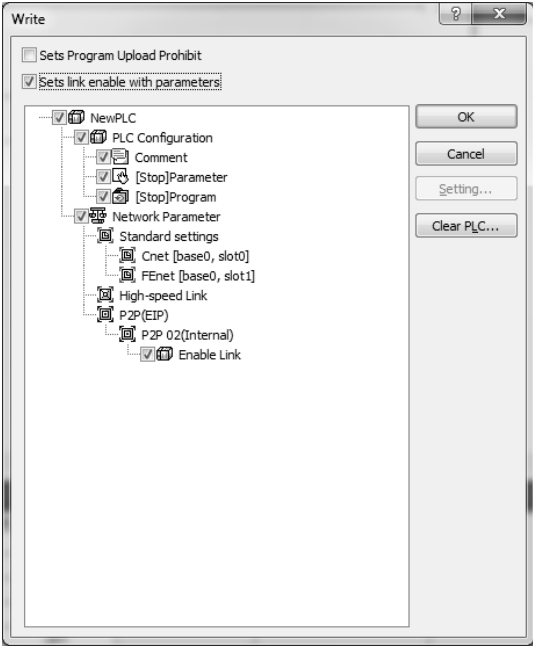
Procedures	Description	
1	Write parameters and Link Enable	
<p>Select [Online] → [Write] in XG5000's project window. After checking [Set together with Link Enable] in the [Write] window, check 'Link Enable' in P2P 02(embedded).</p>		
2	<p>If you click the [OK] button, 'Write Parameters' and 'Link Enable' will be done.</p>	

Notice

- (1) If you set up the parameters for the SMTP relay server to use common E-mails (Gmail, yahoo, etc.), you need to set up for SMTP relay server.
 - Refer to (2) Setting to use the relay server of 1.11.2 E-mail Setting



1.12 Time synchronization(SNTP)

1.12.1 Outline of the time synchronization protocol

The XGB high-performance PLC supports the NTP(Network Time Protocol) that obtains the time information by accessing to the SNTP(Simple Network Time Protocol)server and synchronizes time. The NTP is the protocol to synchronize the time of the PLC connected to the network.

1.12.2 SNTP server parameter setting

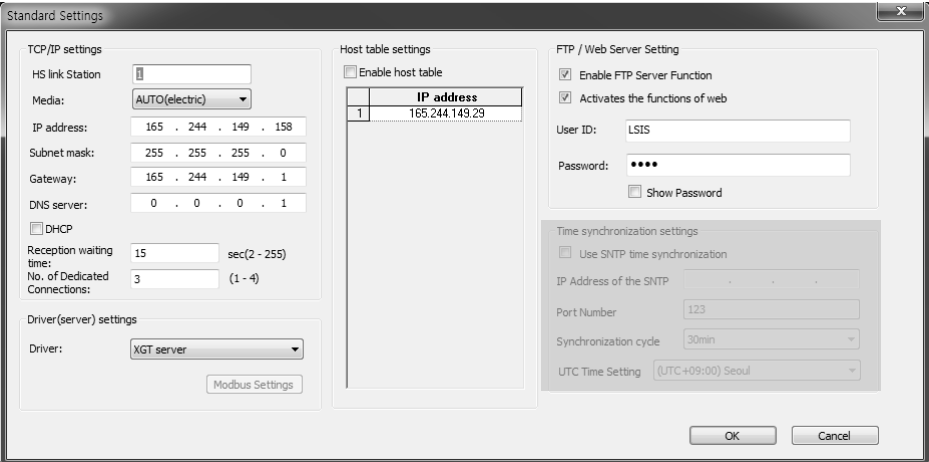
You can set up the parameters to use the SNTP server function as shown below.

Procedures	Description	
1	<p>Setting for SNTP</p>	
2	<p>Write parameters and Link Enable</p>	
	<p>1) Select [Online] → [Write] in XG5000's project window. 2) If P2P Enable is needed, after checking [Set together with Link Enable] in the [Write] window, check 'Link Enable' in P2P 02(embedded).</p>	
3	<p>If you click the [OK] button, 'Write Parameters' will be done.</p>	

Notice

- (1) When parameter setting is done, the PLC reads periodically the time value from the SNTP server.
- (2) In the SNTP server's IP address, the initial '203.248.240.140' port is set as '123'.
This is the open SNTP server called 'Time.bora.net'.
- (3) If you want to use other SMTP servers, change the IP address and port No. of the SNTP server before input. Below is an example of public NTP server and port..

Server address	IP	Port	Support
time.apple.com	17.253.6.243	123	Apple
time.asia.apple.com	17.83.253.7	123	Apple
time.euro.apple.com	17.72.148.52	123	Apple
ntp.komet.net	168.126.3.6	123	KT(Korea)
time.kriss.re.kr	210.98.16.100	123	KRISS(Korea)
time.nuri.net	211.115.194.21	123	inethosting(Korea)
time.nist.gov	132.163.4.102	123	NIST(Korea)
time.windows.com	191.233.81.105	123	MS
1.kr.pool.ntp.org	211.233.40.78	123	Navyism(Korea)
1.asia.pool.ntp.org	125.62.193.121	123	Navyism(Korea)
2.asia.pool.ntp.org	82.200.209.236	123	Navyism(Korea)
3.asia.pool.ntp.org	218.189.210.4	123	Navyism(Korea)

- (4) If you cannot use a public NTP server, Please setup a local NTP server refer to '**1.12.3 How to setup a local NTP server**'.

1.12.3 How to setup a local NTP server

If you cannot use a public NTP server, Please setup a local NTP server as follows:

- 1) Select the [Start] button of Windows for execution.(Shortcut key /Windows key + R)
- 2) Input 'regedit' to the execution window and run the process.

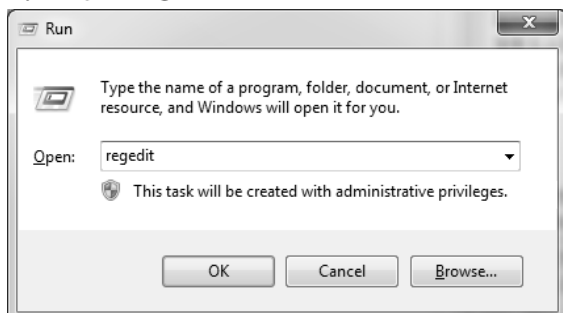

- 3) Check the below path.
HKEY_LOCAL_MACHINE\SYSTEM\CurrentControlSet\Services\W32Time\TimeProviders\NtpServer
- 4) Change the value of 'Enabled' to '1' in the folder.

Enabled	REG_DWORD	0x00000001 (1)
---------	-----------	----------------

- 5) Check the below path.
HKEY_LOCAL_MACHINE\SYSTEM\CurrentControlSet\Services\W32Time\Config
- 6) Change the value of 'AnnounceFlags' to '5' in the folder.

AnnounceFlags	REG_DWORD	0x00000005 (5)
---------------	-----------	----------------

- 7) Reboot the computer.
- 8) Setup inbound firewall rules.
 - (1) Run the Control Panel.
 - (2) Run the Window Firewall
 - (3) When you run the Advanced Settings screen will pop up as shown below.

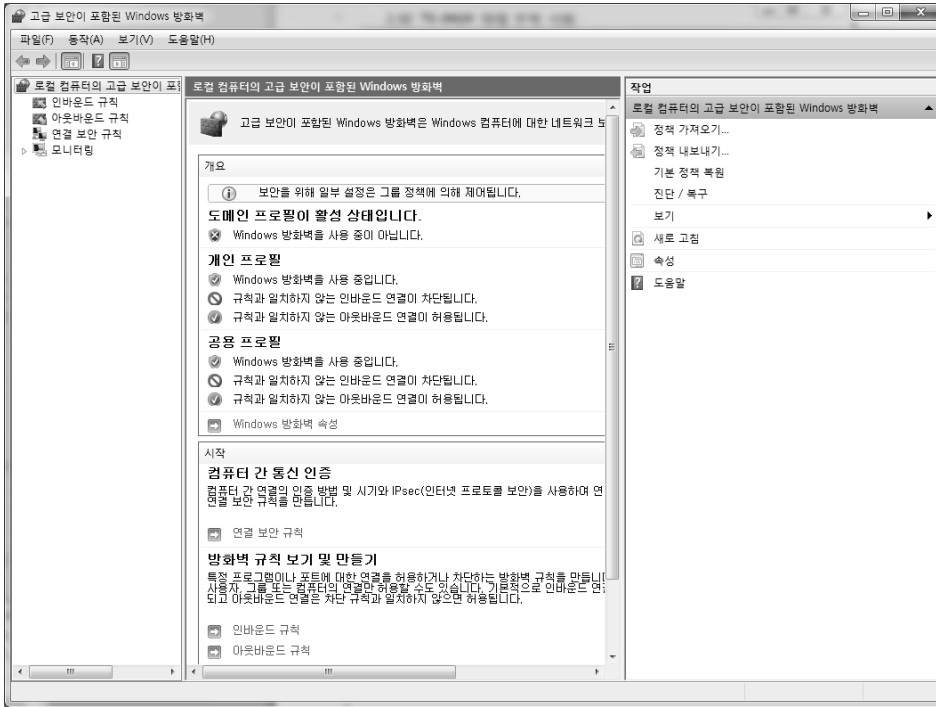

- (4) Select inbound rules.

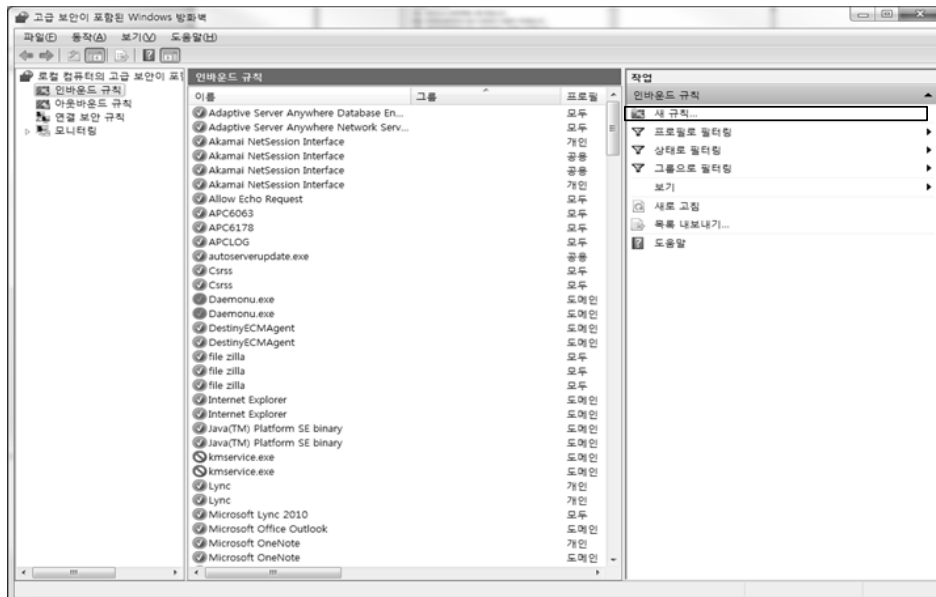

(5) Select the new rule in the top right.



(6) Select the port and click Next button.

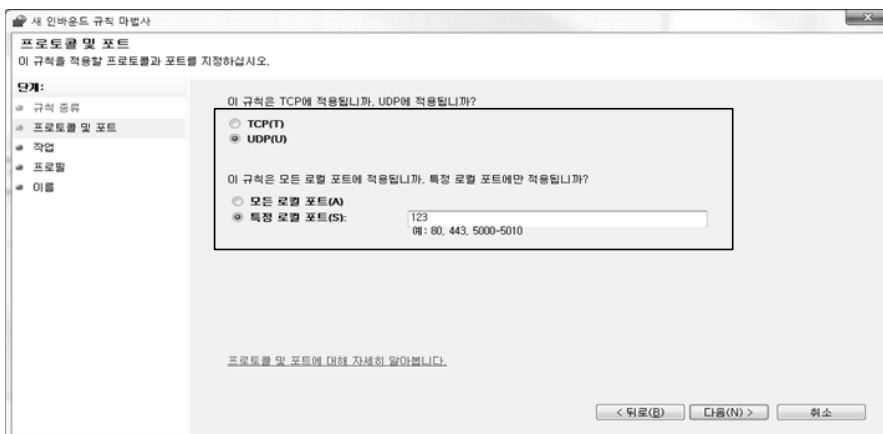

(7) Select **UDP(U)** and **Special local port(S)**. Input '123' and click Next button.

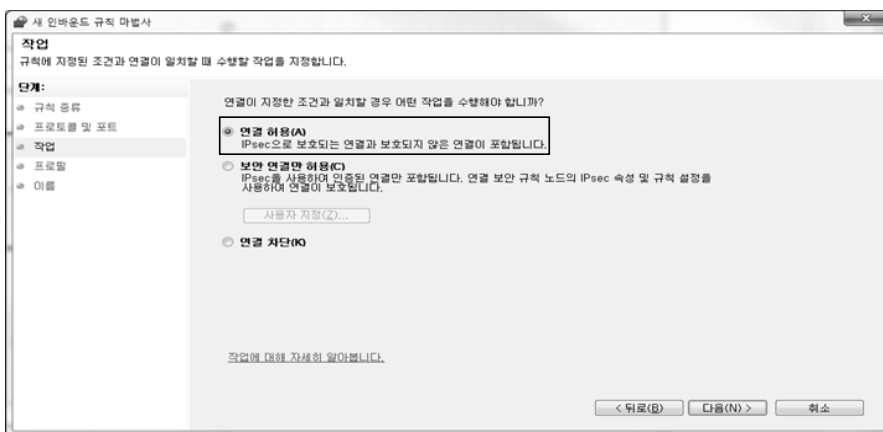

(8) Select **Allow connections(A)** and click Next button.

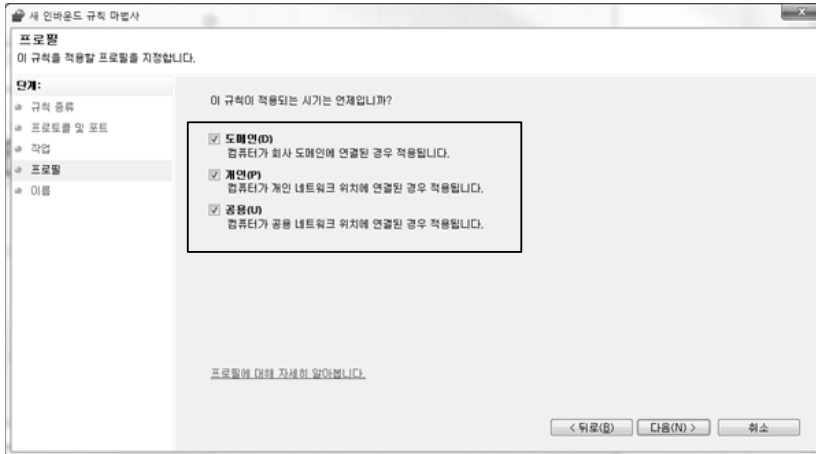

(9) Please select the checkbox to meet your security policy, and click Next button.



(10) Input the server name(anything) and description and click Finish button.

- 9) Select the [Start] button of Windows for execution(Shortcut Key /Windowskey + R)
- 10) Enter '**CMD**' and click Confirm.(Administrator)
- 11) In the command window, Input '**net stop w32time**'and press Enter key. And then, also input '**net start w32time**'and press Enter key.
- 12) Input '**ipconfig**' and press Enter key in the command window to find out the IP address of NTP server.
- 13) Setting the parameters using IP address of NTP server.(refer to '**1.12.2 SNTP server parameter setting**')

1.13 Trouble Shooting

It describes errors that may occur during system operation and provides the causes of errors, corrective measures. You can check whether there are some problems with the XGB embedded FEnet and the details through the below procedures. Please note that we do not provide after-sales service for discretionary repair or disassembly based on the Quality Policy.

Problem	Corrective Measures
In case LINK/ACT LED flickers or is not turned on after connecting to network.	1. Check whether the cables clicked inserted. 2. Check whether the XG-PD parameters are already downloaded. ☞ In case XG-PD's communication basic parameters are not downloaded, you cannot set up Full Duplex /Half Duplex communication.
In case the LINK/ACT, SPEED LED are still turned Off, although you download parameters after supplying power and connecting network	Module defect is suspected so follow-up service may be required.
In case Read/Write Data do not work during dedicated services	1. Check the communication speed(Auto/10/100M-TX) . It should have the same communication speed with the opposing device to be communicated. ☞ In case the device with Auto Negotiation and the device with manual speed are mixed in the network, the former recognizes the latter as Half Duplex(standard specification of IEC 802.3u) 2. Check the IP address settings. The IP should be valid in the network. ☞ In case the set IP addresses are overlapped in the network or invalid IP exists, communication is impossible. 3. Check the driver(dedicated, Modbus TCP/IP) settings. ☞ You should apply the same protocols with the opposing device. 4. Check whether the opposing device's IP is registered in the host table. ☞ When the opposing device's IP address is not registered under host table Enable, communication does not work. 5. Check the MAC Address ☞ In case the MAC Address is abnormal, communication does not work.

Problem	Corrective Measures
In case transmission-reception is impossible during high speed link service	1. Check the communication speed(Auto/10/100M-TX). It should have the same communication speed with the opposing device to be communicated. ☞ The communication speed in the network should be same or set as Auto for communication.
	2. Check the IP address settings. The IP should be valid in the network. ☞ In case the set IP addresses are overlapped in the network or invalid IP exists, communication is impossible.
	3. Check whether the high speed link's parameters are set. ☞ In case the parameters are not set; or the set exchange numbers are overlapped in the network; or you have wrong block setting or block number, communication is impossible.
	4. Check the Link Enable ☞ The frame can be transmitted only when the Link Enable is set.

Chapter 2 Built-in Cnet Communication

2.1 General

Ultimate performance XGB Main Unit has built-in RS-232C 1 channel and RS-485 1 channel.

2.1.1 Characteristic

Main characteristic of built-in Cnet is as shown below.

- (1) By using XG5000 operated in window environment, since the user can write communication speed, communication mode (protocol), connection with external device is easy.
- (2) RS-232C 1 port, RS-485 1 port as main unit built-in Cnet is supported.
- (3) It operates independently according to channel. Since protocol data written by user is managed by main unit, in case communication module is changed, additional setting/download is not necessary.
- (4) Device read/write by using XGT dedicated/modbus/user defined protocol is available.
- (5) It provides communication function in which multidrop, up to 32 connection is available in case of using RS-485.
- (6) Setting of diverse communication speed is available. (1200,2400,4800,9600,19200,38400,57600,115200bps)
- (7) 1:1 and 1:N communication are available.
- (8) With abundant self-diagnosis, trouble diagnosis is simple.
- (9) It supports dedicated server/client, modbus server/client, user defined communication function.

2.2 Specification

2.2.1 Performance Specification

Item		Specification	
		Channel 1	Channel 2
Serial communication method		RS-232C	RS-485
Modem connection function		-	-
Operation mode (Operation define by channel)	P2P	Act as communication client - XGT dedicated protocol client - Modbus ASCII/RTU client - User defined communication - LS Bus Client ^{Notes 1)}	
	Server	- XGT dedicated protocol server - Modbus ASCII/RTU server	
Data type	Data bit	7 or 8	
	Stop bit	1 or 2	
	Parity	Even/Odd/None	
Synchronization type		Asynchronous type	
Transmission speed (bps)		1200/2400/4800/9600/19200/38400/57600/115200 bps available	
Station No. setting		Setting range: 0~255 Max. station No. available: 32 stations	
Transmission distance		Max. 15m	Max. 500m
Diagnosis function		Check available by XG-PD diagnosis service	

Notes

When consisting Client and server, max. 32 stations is possible. Station No. can be set up 0 to 255.

1) Available PLC Area
(1) XBC Series(MK type)

AREA	Device Type	Size(Word)	Remark
P	P0 – P2047	2048	Read, Write Enable
M	M0 – M2047	2048	Read, Write Enable
K	K0 – K8191	8192	Read, Write Enable
F	F0 – F219	200	Read Enable
	F200 – F2047	1848	Read, Write Enable
T	T0 – T2047	2048	Read, Write Enable
C	C0 – C2047	2048	Read, Write Enable
L	L0 – L4095	4096	Read, Write Enable
N	N0 – N10239	10240	Read Enable
D	D0 – D19999	20000	Read, Write Enable
U	U00.00 – U0B.31	384	Read, Write Enable
Z	Z0 – Z127	128	Read, Write Enable
R	R0 – R16383	16384	Read, Write Enable

(2) XEC Series(IEC type)

AREA	Device Type	Size(Word)	Remark
I	%IW0.0.0 ~ %IW15.15.3	1024	Read, Write Enable
Q	%QW0.0.0 ~ %QW15.15.3	1024	Read, Write Enable
M	%MW0 ~ %MW16383	16384	Read, Write Enable
W	%WW0 ~ %WW32767	32768	Read, Write Enable
R	%RW0 ~ %RW16383	16384	Read, Write Enable

2.2.2 Name and Function of Built-in Cnet Part

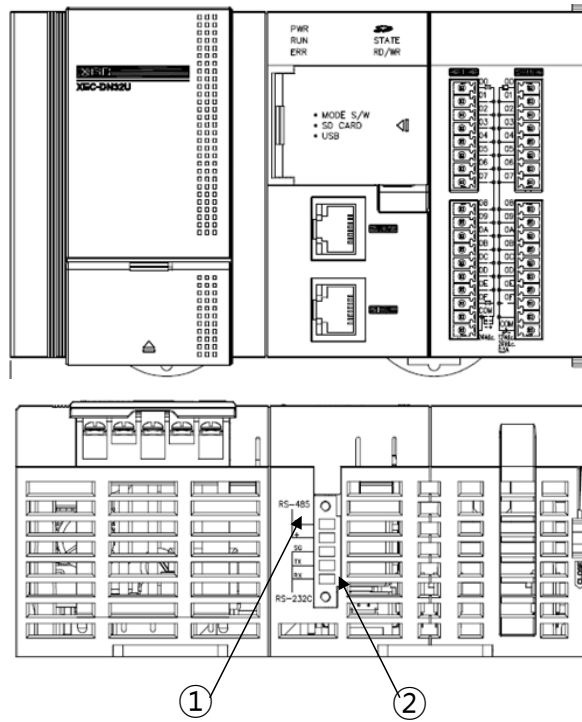

No.	Item	Description
①	RS-485 connection terminal	Built-in RS-485 connection connector
②	RS-232C connection terminal	Built-in RS-232C connection connector

Pin No.	Name	Description	Signal direction (XGBU ↔ External Device)	Function Description
1	485-	485 - Signal	←→	Built-in RS-485- Signal
2	485+	485 + Signal	←→	Built-in RS-485+ Signal
3	SG	Signal Ground	—	Signal ground
4	TX	Transmitted Data	→	Built-in RS-232C transmitted data signal
5	RX	Received Data	←	Built-in RS-232C received data signal

1) Wiring method when using built-in RS-232C

When connecting in null modem mode, connect 3-wire system as follow.

Cnet(9-PIN)		Connection number and signal direction	Computer/ communication device
Pin No.	Name		Name
3	SG		SG
4	TX		TXD
5	RX		RXD

2) Wiring method when using built-in RS-485

Pin No.	Name	Signal direction	External communication device
1	485-	←→	485-
2	485+	←→	485+

2.2.3 Cable Specifications

When using communication channel, RS-485, twisted pair cable for RS-422 shall be used in consideration of communication distance and speed. RS-485.

[Table 2.2.1] describes recommended specifications of cable. Also when using other cable than recommended, the cable conforming to characteristics in [Table 2.2.1] shall be used.

- Product : Low Capacitance LAN Interface Cable
- Type : LIREV-AMESB
- Size : 2P X 22AWG(D/0.254 TA)
- Manufacturer: LS Cable

1) Cable specification

(1) Electrical characteristic

Item	Standard	Test conditions
Withstanding voltage	No destruction	500V/1min
Insulation resistance	1,000 MΩ.km or above	20 °C
Static electricity capacity	45 pF/M or less	1 kHz
Characteristics impedance	120 ± 5 Ω	10 MHz

(2) External characteristic

Item	Unit	Standard
Conductor	Cores	Pair
	Size	AWG
	Composition	No./mm
	Outer dia.	mm
Insulator	Thickness	mm
	Outer dia.	mm

[Table 2.2.1] Cnet twisted pair cable specification

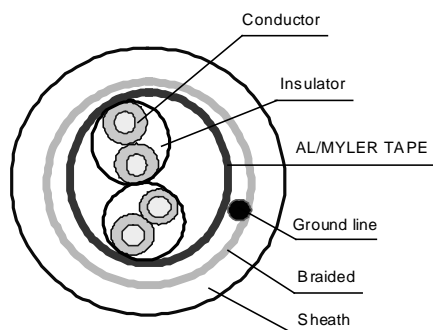

[Figure 2.2.1] Structure

2.2.4 Channel Operation of Built-in Communication

In case of built-in Cnet of XBCU, each communication port operates independently to allow simultaneous Tx/Rx in separate transmission specifications. Transmission specifications can be set per RS-232C and RS-485 channel, and the operation is started and stopped according to channels. Data flow of each channel is as below.

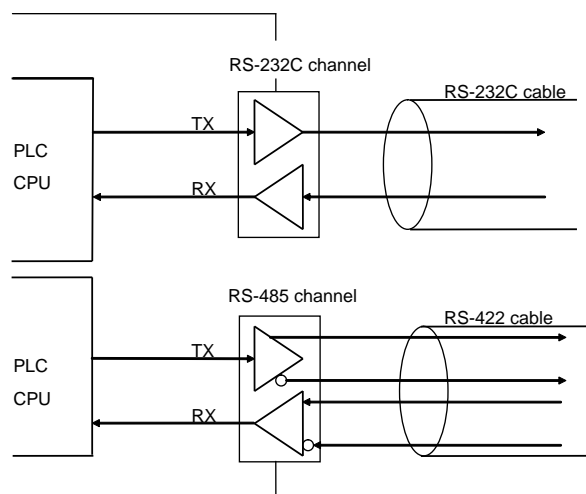

Note

- (1) For mode change during RUN, download parameter by using XG5000.
- (2) Though you don't reset the PLC, if download is complete, changed mode is applied.

2.2.5 Termination Resistor

For communication via XBCU PLC built-in RS-485 channel, termination resistor from external must be connected.

Termination resistor has the function to prevent distortion of signal by reflected wave of cable for long-distance communication, and the same resistance ($1/2W$) as characteristic impedance of cable must be connected to terminal of network.

When using the recommended cable in 2.2.3 connect termination resistor of 120Ω to both ends of cable. Also when using other cable than recommended, the same resistance ($1/2W$) as characteristic impedance of cable must be connected to both ends of cable

- Recommended termination resistor: $1/2W$, 120Ω , 5% tolerance

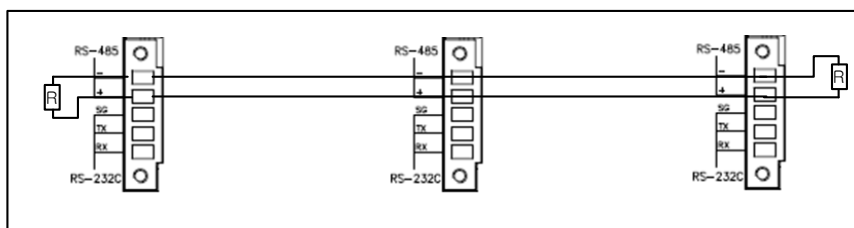

[Termination resistor connection diagram for RS-485]

2.3 Cnet Communication System Configuration

Communication system by using XGB built-in communication function is diverse. In this chapter, it describes system configuration example.

2.3.1 1:1 Connection to PC (HMI) (No Modem)

PC (HMI) and XBCU main unit are connected by RS-232C or RS-485 channel, PC (HMI) and PLC is connected by 1:1 without modem. In most case, PC (HMI) acts as client and Cnet I/F module acts as server which respond request of PC (HMI). Since there is no modem, in case of using RS-232C channel, communication distance is max 15m, in case of using RS-422 channel, communication distance is max 500m. Operation mode of Cnet I/F is set according to PC (HMI)'s communication method.

1) In case of using 1:1 connection with normal PC

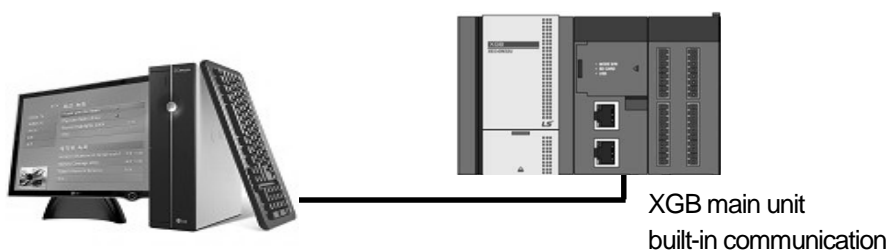

• Wiring method

External form of PC	PC	Connection number and signal direction	XGB main unit		XGB external form
	Pin no.		Pin no.	Signal name	
<p>Female Type</p>	1		1	485-	
	2 (RXD)		2	485+	
	3(TXD)		3	SG	
	4		4	TX	
	5(GND)		5	RX	
	6				
	7				
	8				
	9				

In case of using channel 2, connect 485+ and 485- of RS485 terminal.

2) In case of using 1:1 connection with monitoring device such as XGT Panel

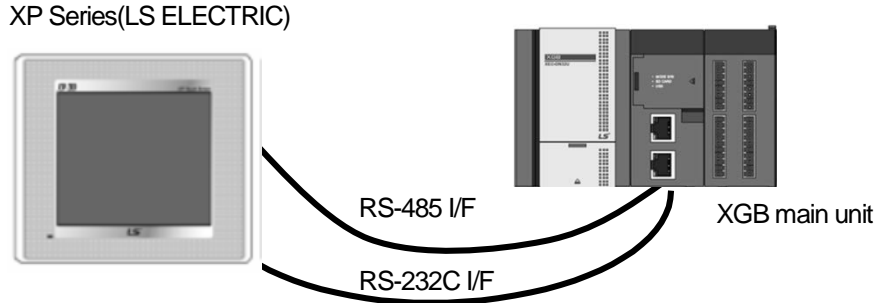

• Wiring method (RS-232C)

XP external form	XP	Connection number and signal direction	XGB main unit		XGB external form
	Pin No.		Pin No.	Signal Name	
<p>Female Type</p>	1		1	485-	
	2(RXD)		2	485+	
	3(TXD)		3	SG	
	4		4	TX	
	5(GND)		5	RX	
	6				
	7				
	8				
	9				

Note) In case of PMU, short no.4 and no.6, short no.7 and no.8.

• Wiring method (RS-485)

PMU	Connection no. and signal direction	XGB main unit
485+	←→	485+
485-	←→	485-

3) In case of using 1:1 connection with XGB main unit

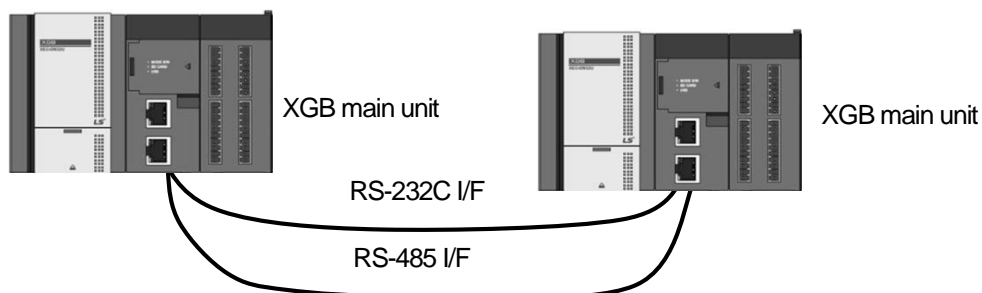

• Wiring method

XGB external form	XGB main unit	Connection no. and signal direction	XGB main unit	
	Pin No.		Pin No.	Signal name
<p>The diagram shows a vertical connector with five pins. From top to bottom, the pins are labeled: RS-485 (with a '-' sign), RS-485 (with a '+' sign), SG, TX, and RX. The RS-485 and RS-232C labels are positioned to the left of the connector.</p>	1	↔	1	485-
	2	↔	2	485+
	3	—	3	SG
	4	↔	4	TX
	5	↔	5	RX

2.3.2 Dedicated Modem Connection with PC(HMI)

It is 1:1 communication system connected through dedicated modem through RS-232C channel with PC (HMI). Normally, PC (HMI) acts as client station, Cnet I/F module acts as server station which respond request of PC (HMI). Since it uses modem, RS-232C channel should be set as dedicated modem and long distance communication is available. Operation mode of this module should be set according to communication method of PC (HMI).

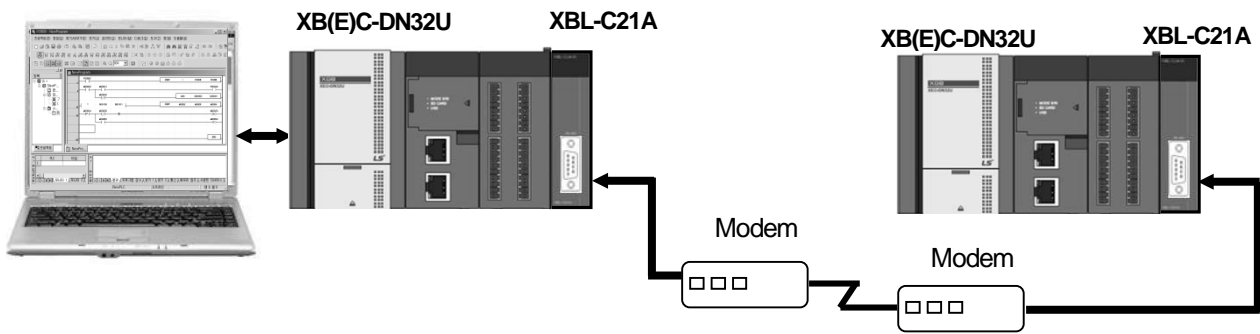

2.3.3 Modem Connection with PC and Communication between Cnet I/F Modules

- PC and Cnet #1 station is connected by modem through RS-232C channel
- Cnet #1 station ~ N station is communication between Cnet I/F module through RS-422 channel
- Cnet #1 station ~ N station is Communication between Cnet I/F modules through RS-422 channel
- PC acts as client station of Cnet #1 station
- Up to max 32 station connection is available in case of Cnet I/F module (RS-422/485 communication)
- It sets station 1 among Cnet I/F module as server station
- Dedicate modem or dial-up modem available

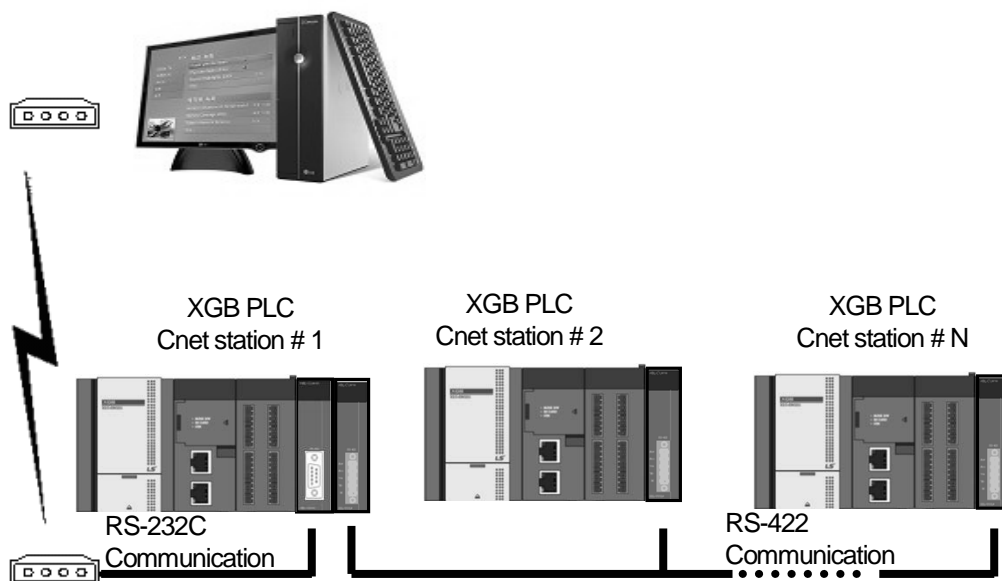

Type	Module setting	
	XBL-C41A	Station no.
PLC Cnet #1	P2P	1
	XGT client	
Cnet #2 ~ #N	XGT server	2~N

2.3.4 Dedicated Communication with PC(HMI) and Different type RS-422 Communication

- Null-modem communication by using PC (HMI) and RS-232C channel
- PC (HMI) acts as client station, Cnet I/F module acts as server, at this time, module setting acts as RS-232C XGT server
- Cnet I/F module RS-422 channel acts as P2P mode.
- It transmits indication data to display module of mosaic panel through RS-422 channel
- Reading display transmission data from PC

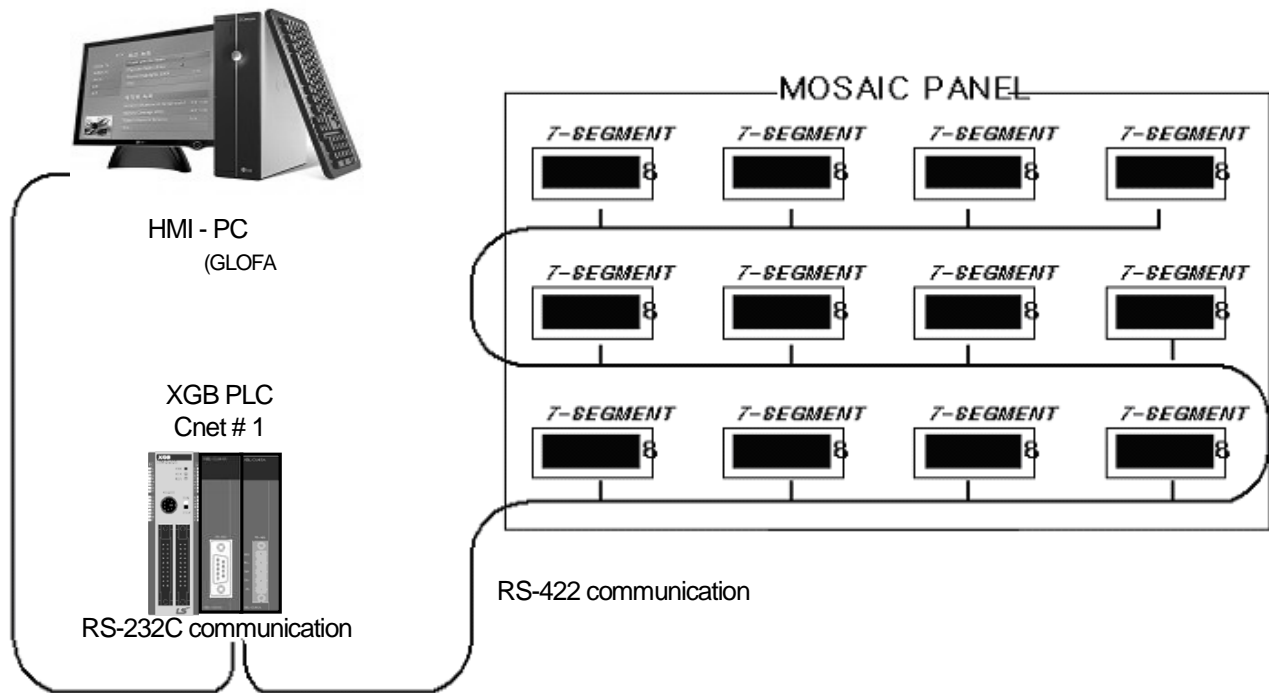

Type	Module setting		
	XBL-C21A	XBL-C41A	Station no.
PLC Cnet #1	XGT server	P2P	1

2.3.5 Optical Modem Communication for Moving Material Communication

- Optical modem communication system for Cnet communication on material above moving linearly
- P2P communication or dedicated mode communication with monitoring device
- RS-232C/RS-422 communication with optical modem
- Communication between Cnet I/F module is dedicated server/client communication
- Optical modem connected with Cnet I/F module on mobile body can communicate with the other optical modem only when positioned in communication available
- Main application: Parking tower

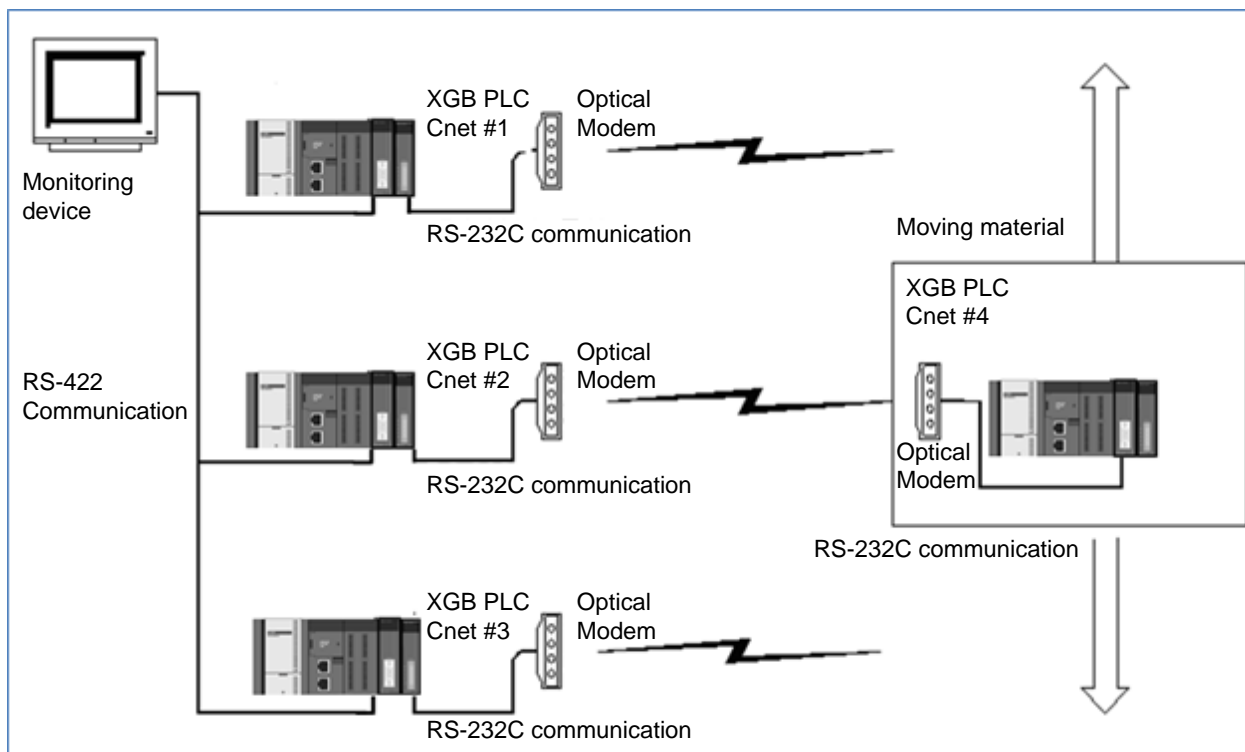

2.3.6 Wireless Modem Communication for Communication between Revolution Bodies

- Wireless modem communication system for Cnet communication on the revolution bodies
- RS-232C communication with wireless modem
- Communication between Cnet I/F module is dedicated/client communication
- RS-232C channel of Cnet I/F module is dedicated modem mode

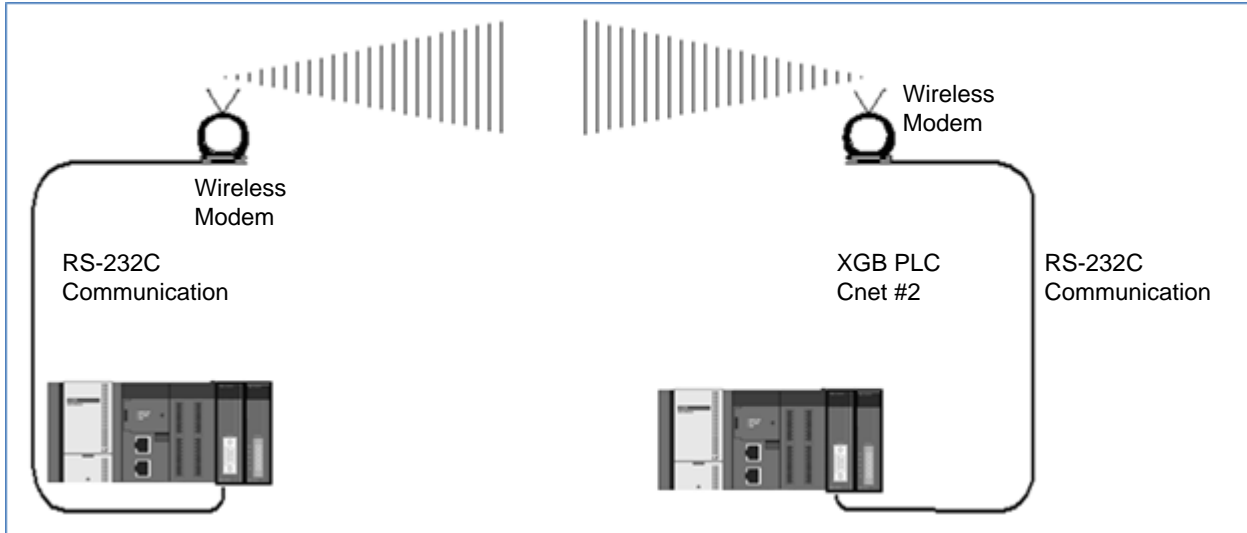

Type	Module setting		
	RS-232C	RS-422	Station
XBL-C21A	Dedicated mode	Not used	2 station
	User mode		

Note

Attach RS-232/485 terminal block when Power is Off and tighten the screw bolt.
 Don't detach the terminal block when Power is On. Detach the terminal block when power is Off

2.4 Basic Setting for Communication

2.4.1 PLC Type Setting and Communication Module Registration

To use Cnet I/F function, communication parameter should be written by XG5000 and the module should be registered in XG5000. Method on register Cnet I/F module is as follows according to On/Off line status.

1) Making new project

First, after click Project-New Project and input project name, select XGB as CPU series.

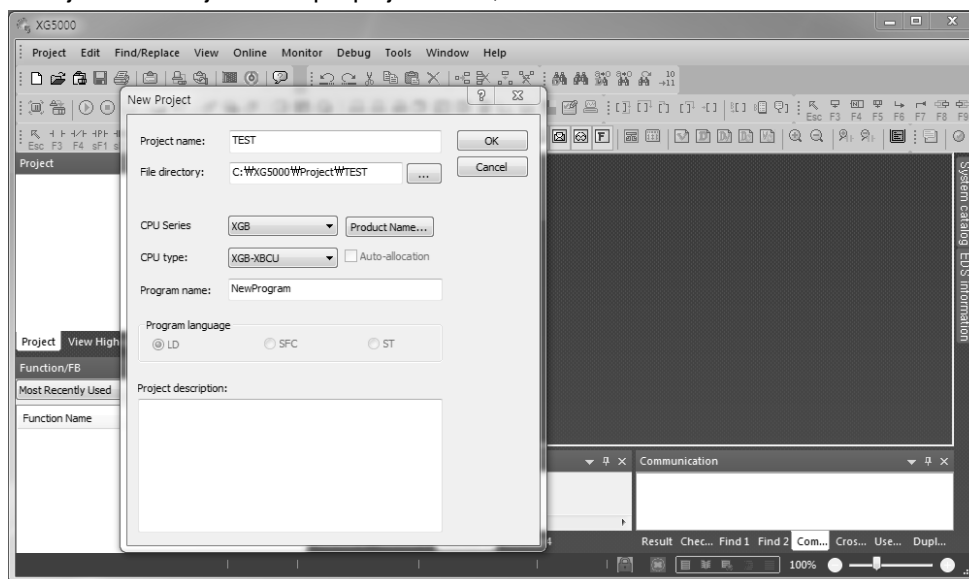

2) In case of off-line, method on Cnet I/F module registration

In the status PLC is not connected, in case the user set about communication module and write parameter related with communication. In the “project” window, select “Basic Network” and then click mouse right button. Select “Add item – Communication module”. In the window, click “Add Module...” to register Cnet I/F module.

At this time, slot 0 is set as built-in Cnet. In case of using Cnet module other than built-in Cnet, registration is necessary.

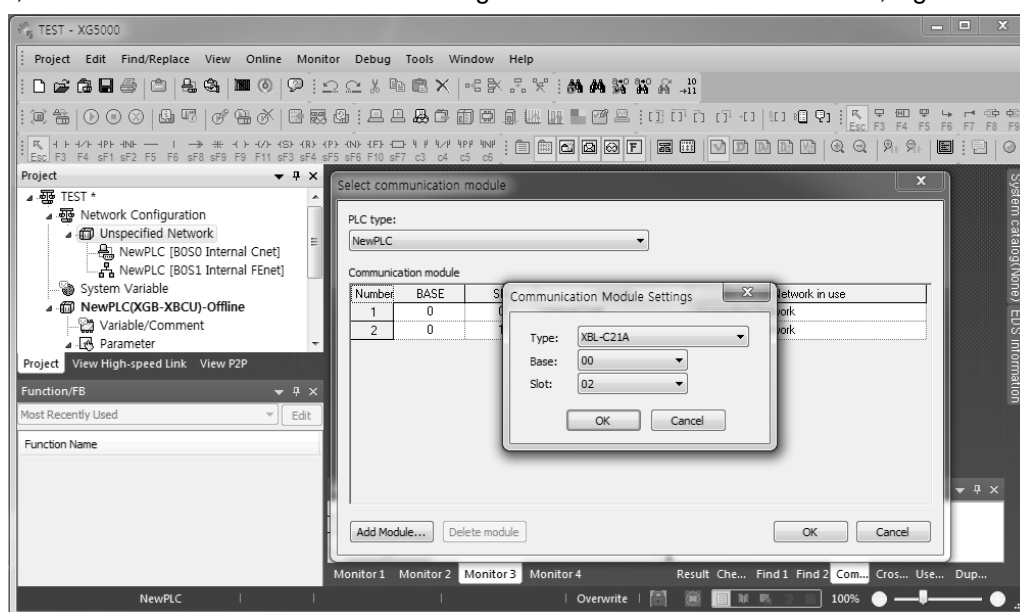

[Cnet module registration]

3) In case of on-line, method on Cnet I/F module registration

If you register communication module at online status by using XG5000, you should connect basic unit. After [Online]-> [Connect] after doing communication setting by using "Online -> Connection settings" and doing local connection. When selecting [Project] -> [Open from PLC], equipped communication module is searched automatically.

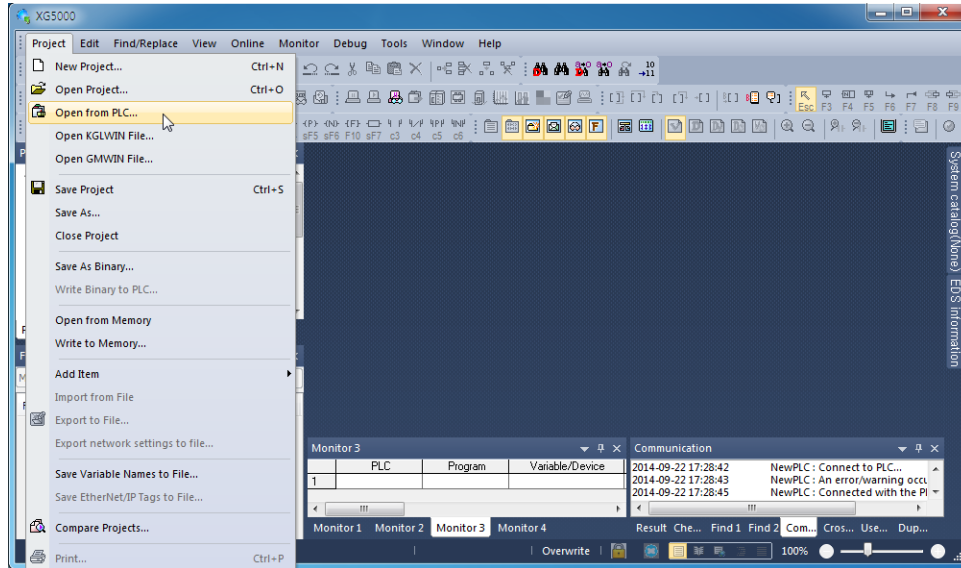

[Screen of "Open from PLC"]

At this time, in case registered module is different with currently connected module or type of communication module in the previous project, it shows whether it changes or not with the following message.

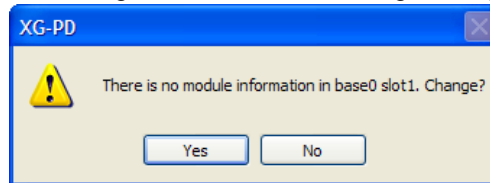

[I/O information change message]

If you execute Read IO Information, equipped communication module like the following is indicated IO module information window.

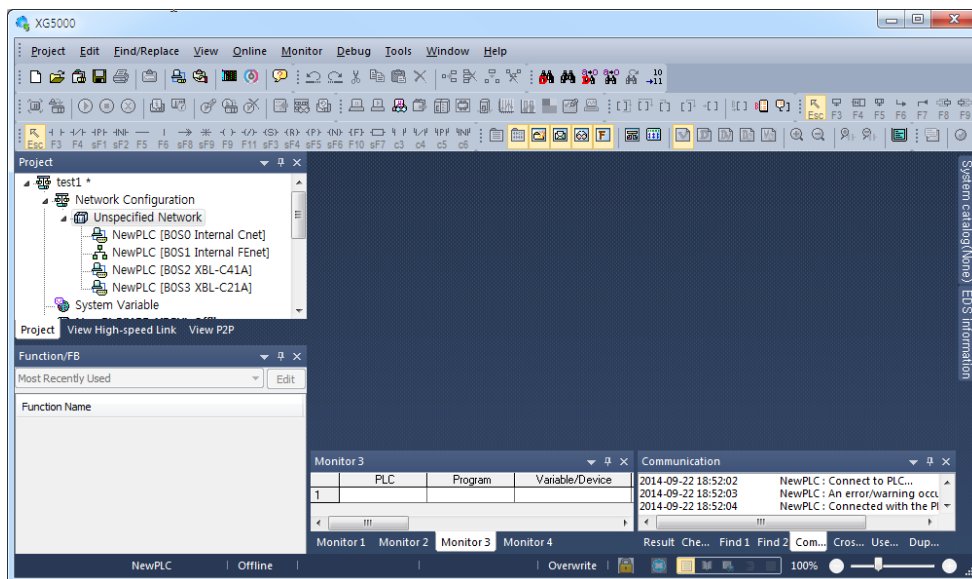

[Communication module registration complete screen]

4) How to read the parameter saved in PLC

The method to read basic setting value and P2P setting value of communication module saved in PLC is as follow. While connecting to main unit, select [Project] -> [Open from PLC]. After setting "Online Settings", click "OK" and then the saved parameter and project in PLC is opened as follow.

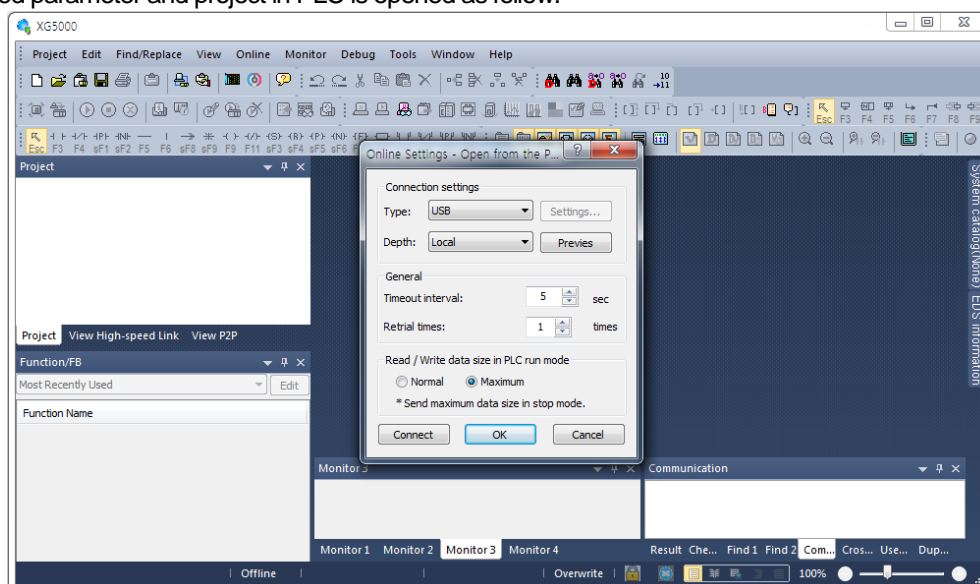

[Open from PLC]

2.4.2 Basic Parameter Setting

Communication function used in Cnet I/F module is classified as followings.

5) Server mode service

Without other program at PLC, you can read or write information in PLC and data.

- It can act as XGT server providing XGT dedicated protocol and Modbus server providing RTU/ASCII protocol.

6) Client (P2P) service

Cnet I/F module acts as client in network.

- In case designated event occurs, you can read or write memory of other station.
- It can act as XGT client and Modbus client.
- In case of sending/receiving user wanted frame and communicating with other device.
- You can define P2P block with max. 32 per one channel acting independently.

7) Loader service

By using remote 1/2, you can monitor/download program about remote PLC.

To use Cnet I/F module, you should set transmission specification such as data type like transmission speed and data/stop bit.

You should select transmission specification of system to be same with specification of system.

Written standard setting value is saved main unit of PLC and this value keeps though power goes off and this value is not changed before writing. Also though Cnet I/F module is changed and new module is installed, the standard setting value saved at main unit previously written is applied to new module automatically. Standard communication setting parameter and P2P, all parameter is applied if download is complete.

8) Setting Item

When setting Cnet communication parameter, the user should define as follows.

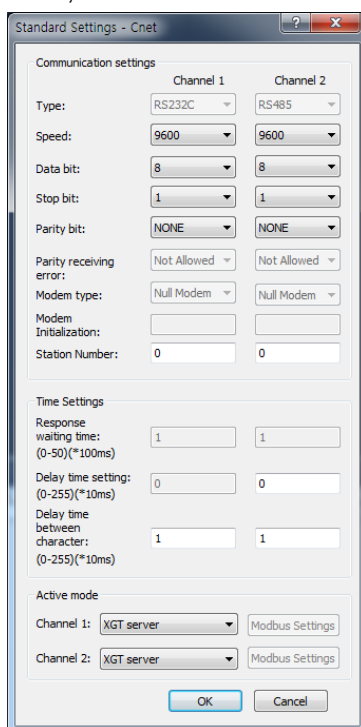

[Built-in communication standard setting screen]

Item	Setting content
Station no.	• set from station 0 to station 255.
Speed	• 1200, 2400, 4800, 9600, 19200, 38400, 57600, 76800, 115200 bps available
Data bit	• 7 or 8 bit available
Parity bit	• None, Even, Odd available
Stop bit	• 1 or 2 bit available
Modem initialization	• When using dialup modem, the function is available. In case of modem communication, input the initialization instruction of applied modem.
Type	• It is fixed as follows according to Cnet type 1) Built-in communication → channel 1 : RS-232C , channel 2 : RS-485 2) XBL-C41A → channel 1 : not used, channel 2: RS-422/RS-485 3) XBL-C21A → channel 1 : not used, channel 2: RS-232C
Response waiting time	• It means the time from sending frame to receiving. 1) operation setting : it is available when active mode is set to "Use P2P". 2) waiting time : 100ms+(setting value × 100ms)
Delay time Setting	• It means that frame is sent at user-defined frame send timing with delay as setting delay time. 1) operation setting : it is available when communication type is RS-422/485.
Delay time between characters	• It means interval between characters in one frame. 1) operation setting : it is always available regardless of active mode. 2) In case of that waiting time is set to 0, it is applied 3.5 character time ¹⁾ as communication speed..

[communication parameter setting item]

The meaning of each items is as follows.

-Parity bit

Cnet I/F module can define three parity bits. Meaning of each parity bit is as follows.

Parity bit type	Meaning	Reference
None	Not using parity bit	
Even	If the number of 1 in one byte is even, parity bit becomes "0".	
Odd	If the number of 1 in one byte is odd, parity bit becomes "0".	

[Parity content table]

-Operation mode setting

▪ Sets operation mode

Driver type	Meaning	Reference
P2P	Each port acts as client and executes the communication by setting P2P parameter.	P2P setting reference
XGT server	It acts as XGT server supporting XGT dedicated communication.	Dedicated service
Modbus ASCII server	It acts as Modbus ASCII server	Modbus communication
Modbus RTU server	It acts as Modbus RTU server	Modbus communication

[Operation mode setting item]

Note

Character Time: It means the required time to send 1 character and it is variable depends on communication speed.

1) In case of that communication speed is 9600bps, how to calculate 3.5 Character Time

$$\begin{aligned} \text{Character time} &= (\text{number of bits of 1 character}(11)/\text{communication time}) * 3.5 \\ &= (11/9600)*3.5 \\ &= 4.01\text{ms} \end{aligned}$$

9) Parameter download

You should do like following to operate Cnet I/F module according to communication specification defined by user. In case of setting like the followings about XBL-C41A (RS-422/485 1 port) installed slot 3, setting method is as follows.

(1) Communication specification

- Channel 2: RS-485, 115200Bps, 8/1/Odd, Null modem, P2P, station 0, Response waiting time 100ms, Delay time 10ms,

Waiting time between characters 0ms, XGT server

(2) Executing XG5000, you register communication module Cnet for setting at each slot position.

(3) After Cnet module is registered, if you double-click Cnet module, the following standard setting window shows.

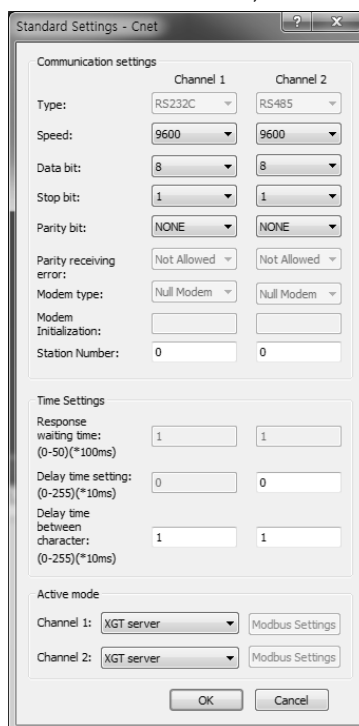

[Communication module setting screen]

(4) If standard communication parameter setting ends, download Cnet module.

If you select [Online -> connection -> Write], download is executed. After downloading, parameter is applied shortly.

If you check 'Set up with Link Enable', Link Enable can be applied with writing P2P/HS parameters at the same time.

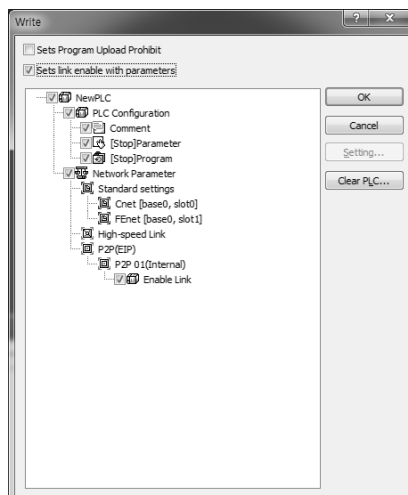

2.5 Server Function and P2P service

2.5.1 Server Function

Dedicated service is built-in service in Cnet I/F module. Without specific program at PLC, you can read or write information and data from PC and other device. It acts as server at communication network and if read, write request conforming XGT dedicated protocol or Modbus protocol come, it responds.

10) XGT dedicated server

It is used in case of communication between our products by our dedicated service, all characters are configured as ASCII code. In case of using multi drop, up to 32 stations can be connected. In case of setting station number, duplicated station number should not be set. In case of using multi drop, communication speed/stop bit/parity bit/data bit of all Cnet I/F module in network should be same. For more detail protocol, refer to "chapter 2.7 XGT dedicated protocol".

11) Modbus server

It is used in case partner device acts as Modbus client.

ASCII mode and RTU mode of Modbus are all supported. You can define in standard settings active mode. For more detail protocol, refer to "chapter 2.8 Modbus protocol".

The image shows a software dialog box titled "Standard Settings - Cnet". It is divided into several sections:

- Communication settings:** This section is split into two columns for "Channel 1" and "Channel 2".
 - Type: Channel 1 is set to "RS232C", Channel 2 is set to "RS485".
 - Speed: Both are set to "9600".
 - Data bit: Both are set to "8".
 - Stop bit: Both are set to "1".
 - Parity bit: Both are set to "NONE".
 - Parity receiving error: Both are set to "Not Allowed".
 - Modem type: Both are set to "Null Modem".
 - Modem Initialization: Both are empty text boxes.
 - Station Number: Both are set to "0".
- Time Settings:**
 - Response waiting time: (0-50)(*100ms) - Channel 1: "1", Channel 2: "1".
 - Delay time setting: (0-255)(*10ms) - Channel 1: "0", Channel 2: "0".
 - Delay time between character: (0-255)(*10ms) - Channel 1: "1", Channel 2: "1".
- Active mode:**
 - Channel 1: "XGT server" (dropdown), with a "Modbus Settings" button next to it.
 - Channel 2: "Modbus RTU server" (dropdown), with a "Modbus Settings" button next to it.

At the bottom of the dialog are "OK" and "Cancel" buttons.

Modbus instruction and response data max. number which is supported by Modbus RTU/ASCII driver are as follows. Other client device should request in the range of the following table.

Code	Purpose	Address	Max. no. of response data
01	Read Coil Status	0XXXX	2000 Coils
02	Read Input Status	1XXXX	2000 Coils
03	Read Holding Registers	4XXXX	125 Registers
04	Read Input Registers	3XXXX	125 Registers
05	Force Single Coil	0XXXX	1 Coil
06	Preset Single Register	4XXXX	1 Register
15	Force Multiple Coils	0XXXX	1968 Coils
16	Preset Multiple Registers	4XXXX	(120) gisters

2.5.2 P2P Service

P2P service means acting client operation of communication module. P2P instructions available at Cnet I/F module are 4 (Read/Write/Send/Receive).

Registration and edit of P2P service is executed in XG5000, each P2P parameter consists of max. 32 P2P block.

The following figure is example of P2P parameter setting window of XG5000.

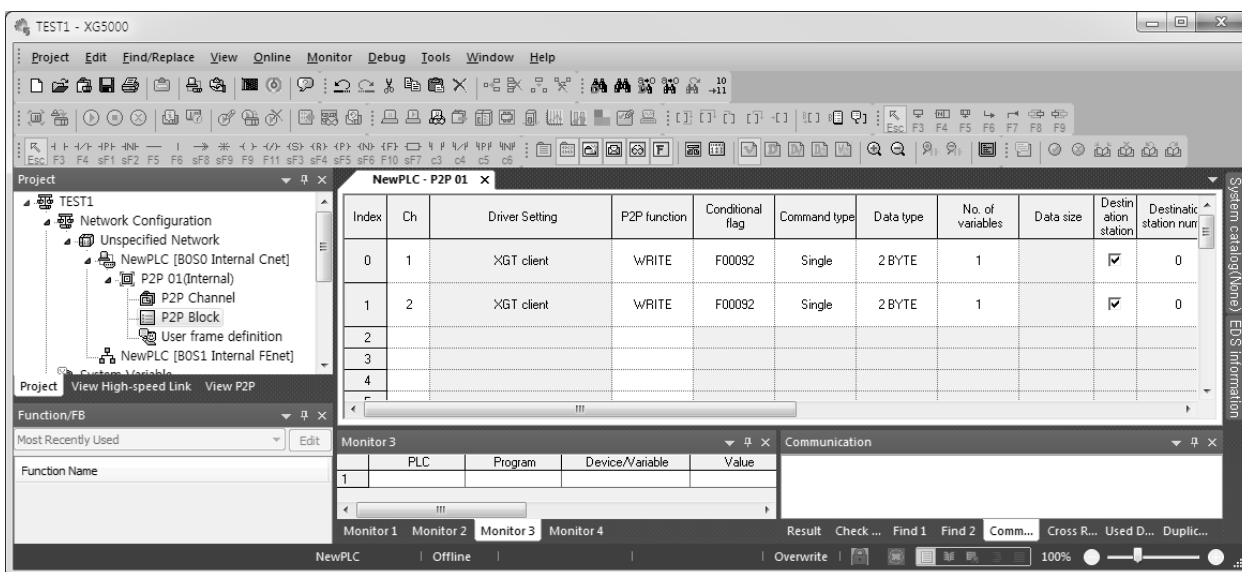

Note

P2P 01 is fixed allocated at built-in Cnet, and P2P 02 is fixed allocated at built-in FEnet. Therefore, it will operate normally with appropriate slot number.

12) P2P parameter configuration

To use P2P service, the user executes the setting for the wanted operation at the P2P parameter window. Like the following figure, P2P parameter consists of three informations.

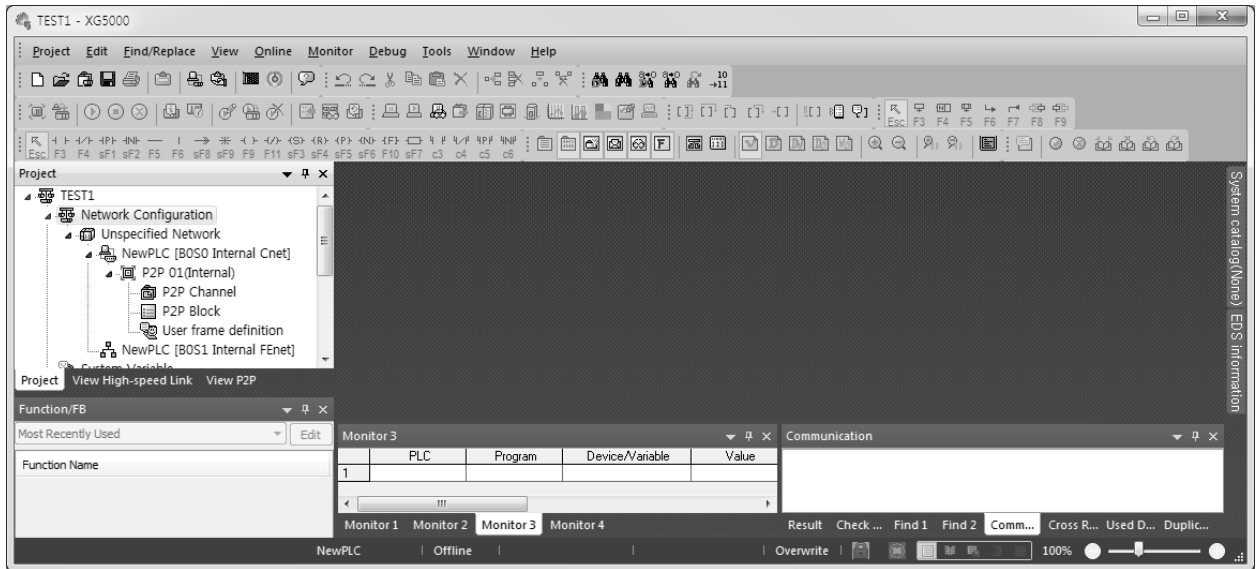

Types	Descriptions	Remark
P2P channel	<ul style="list-style-type: none"> - P2P channel setting defining communication protocol of P2P service to execute - XGT/Modbus available - Each channel is independent. It is applied when active mode is "Use P2P settings" 	
P2P Block	Setting P2P block of 32 acting independently	
User frame definition	User frame definition registration	

13) Channel Setting

Built-in Cnet I/F function provides two fixed communication channel as fixed P2P 1.

Cnet I/F module are allocated P2P 2 and P2P 3 according to equipment sequence and communication channel supports only one channel.

At Built-in Cnet I/F, you can define driver type for P2P service about each.

If you select P2P channel at P2P setting window, like the following, P2P channel setting window shows. If you select P2P driver to use, setting is complete.

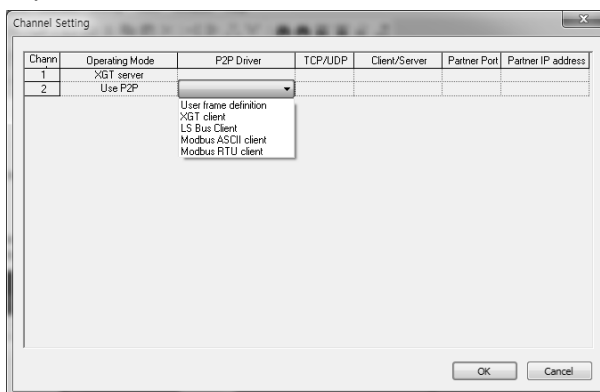

Driver	Meaning
None	Not using P2P service
User frame definition	In case of transmitting/receiving user frame definition
XGT client	Select in case of executing read, write of XGT memory.
Modbus ASCII client	Select in case of acting as Modbus client, using ASCII mode
Modbus RTU client	Select in case of acting as Modbus client, using RTU mode.

About communication channel, in case of selecting P2P driver as XGT or Modbus, user frame definition cannot be used.

14) Block information

If you select P2P block of each parameter at P2P parameter setting window, P2P block setting window shows. Setting value of P2P block will be displayed differently as user sets the P2P Driver of channel.

P2P Channel			P2P Block Setting												
Channel	Operating Mode	P2P Driver	NewPLC - P2P 01 X												
1	Use P2P	XGT client	Index	Ch	Driver Setting	P2P function	Conditional flag	Command type	Data type	No. of variables	Data size	Destination station	Destination station number	Frame	Setting
			0	1	XGT client							<input checked="" type="checkbox"/>	0		Setting
Channel	Operating Mode	P2P Driver	NewPLC - P2P 01 X												
1	Use P2P	Modbus ASCII client	Index	Ch	Driver Setting	P2P function	Conditional flag	Command type	Data type	No. of variables	Data size	Destination station	Destination station number	Frame	Setting
			0	1	Modbus ASCII client					1		<input checked="" type="checkbox"/>	0		Setting
Channel	Operating Mode	P2P Driver	NewPLC - P2P 01 X												
2	Use P2P	Modbus RTU client	Index	Ch	Driver Setting	P2P function	Conditional flag	Command type	Data type	No. of variables	Data size	Destination station	Destination station number	Frame	Setting
			0	2	Modbus RTU client					1		<input checked="" type="checkbox"/>	0		Setting
Channel	Operating Mode	P2P Driver	NewPLC - P2P 01 X												
2	Use P2P	User frame definition	Index	Ch	Driver Setting	P2P function	Conditional flag	Command type	Data type	No. of variables	Data size	Destination station	Destination station number	Frame	Setting
			0	2	User frame definition										Setting

[P2P block setting screen]

You can set up to 32 independent blocks. If you select temporary block, you can designate each block operation by selecting instruction.

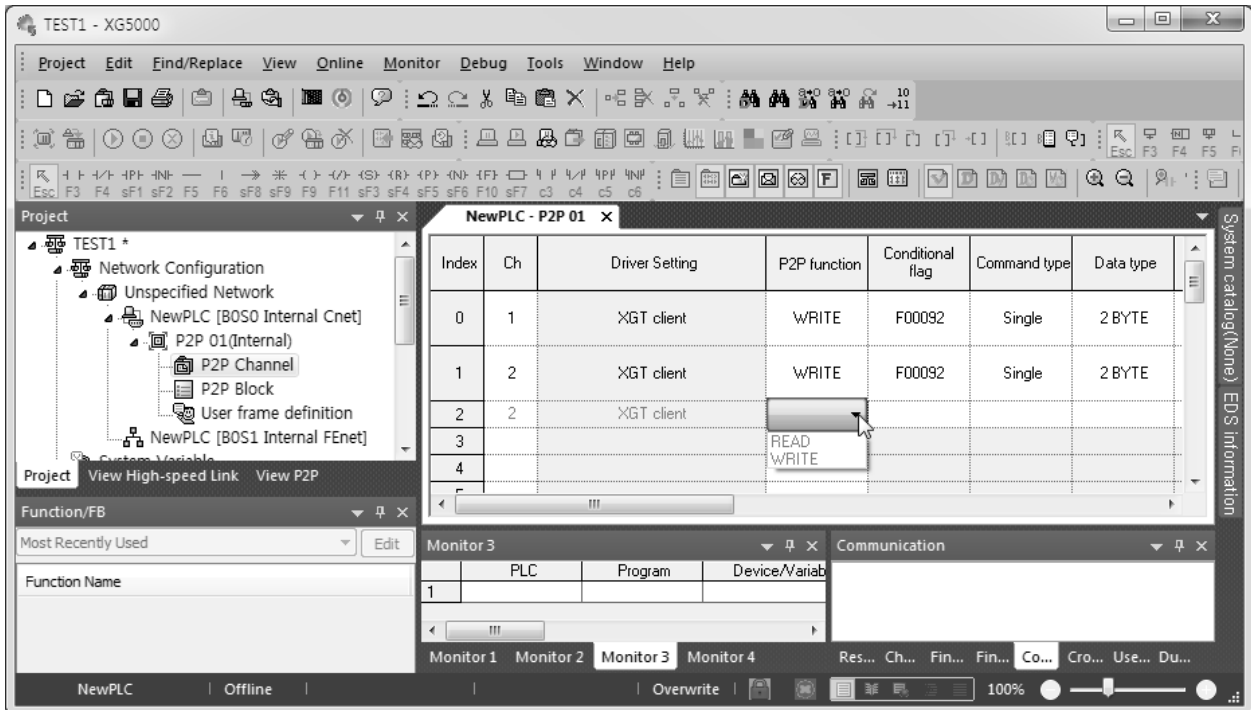

[P2P instruction screen]

2.5.3 XGT Client Service

When using the XGT protocol, XGT client requests writing/reading the data. XGT server analyzes the received data. In case of normal frame, XGT server deals with the received data with ACK response and in case of abnormal frame, XGT transmits the NAK response including error code to XGT client.

1) Channel setting

Cnet I/F module is available to define driver type for P2P service about each channel. However, active mode in the standard settings should be set as "Use P2P settings". P2P setting according to active mode is as follows.

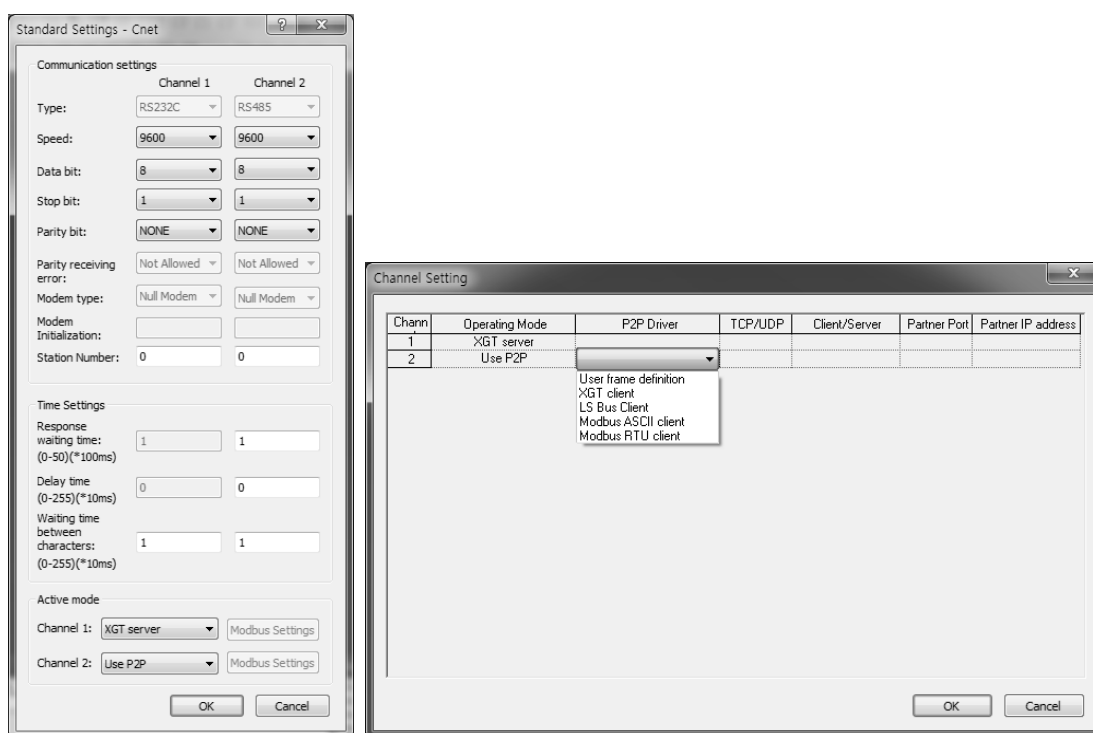





2) P2P block setting

If selecting P2P block in the P2P parameter setting window, P2P block setting window shows.

Block setting window is same according to protocol and activated area is different P2P. Each of items means as follow.

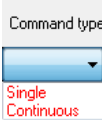
Index	Ch	Driver Setting	P2P function	Conditional flag	Command type	Data type	No. of variables	Data size	Destination station	Destination station number	Frame	Setting
0	2	XGT client							<input checked="" type="checkbox"/>	0		Setting
	①		②	③	④	⑤	⑥	⑦	⑧	⑨		⑩

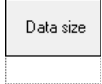
No.	Type	Block form	Contents
1	Channel		Driver name changes according to driver set in the P2P Driver.
2	P2P function		1. Read : when reading the destination station's memory 2. Write: when writing self-station's memory to destination station's memory.
3	Conditional flag		1. Determines when Cnet sends request frame 2. In case of XBC type Ex. : F90(20ms flag), M01 3. In case of XEC type Ex. : _T20MS(20ms flag), %MX01

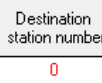
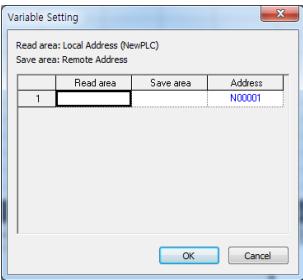
No.	Type	Block form	Contents
4	Command type		<ol style="list-style-type: none"> Single: When reading/writing max. 4 memory areas. (Ex. : M01, M10, M20, M30) Continuous: When reading/writing continuous memory areas. (Ex. : M01~M10)
5	Data type		<ol style="list-style-type: none"> In case that command type is single: bit, 1 byte, 2byte, 4 byte, 8 byte available In case that command type is continuous: 1 byte, 2byte, 4 byte, 8 byte
6	No. of variable		<ol style="list-style-type: none"> This is activated when command type is single and available max. no. is 4. When command type is continuous, it is fixed as 1.
7	Data size		<ol style="list-style-type: none"> This is activated when command type is continuous. When data type is 1 byte, available max. no. is 120 byte
8	Destination station		<ol style="list-style-type: none"> Check: Specify the destination station Uncheck: In case of using P2PSN command, communicate with previously designated (P2PSN)destination station
9	Destination station number		<ol style="list-style-type: none"> Destination station number, setting range is 0~63.
10	Setting		<ol style="list-style-type: none"> When P2P function is Read <ol style="list-style-type: none"> Read area : device area of server Save area : client's device to save the data from server When P2P function is Write <ol style="list-style-type: none"> Read area : device area of client Save area : Server's device area to save client's data

3) Writing parameter

After P2P block setting is completed, download setting parameter to CPU.

Select [Online] – [Connect] – [Write], and click OK in parameter download window, and then it will be downloaded.

After download, the parameter is applied immediately. If you check 'Set up with Link Enable', Link Enable can be applied with writing P2P/HS parameters at the same time.

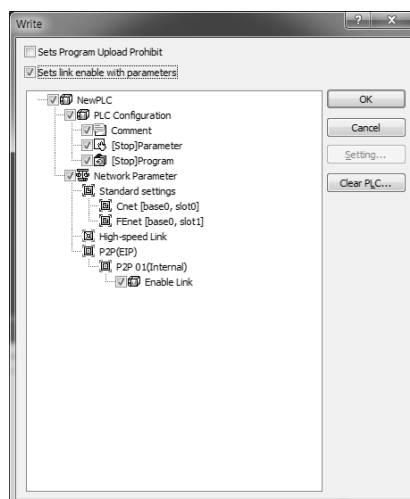

4) Enabling link

After setting P2P parameter and downloading the parameter to PLC CPU, enable P2P service. If parameter is downloaded but P2P(EIP) is not enabled, the P2P block is not operated. In order to enable P2P(EIP), Select [Online] – [Communication module setting] – [Enable Link], and click P2P(EIP) number which you want to operate and then click Write button. The P2P(EIP) is enabled.

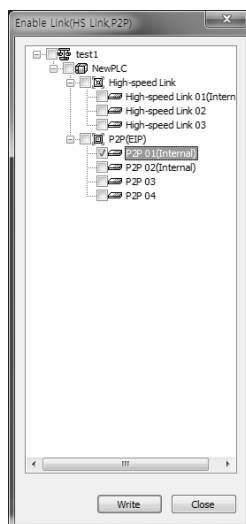

5) Diagnosis service

In order to check the setting parameter operates normally, diagnosis service is available.

Select [Online] – [Communication module setting] – [System Diagnosis]. Click the module and then click mouse right-button. If you select Frame Monitor or Status by Service, it can be checked whether the communication is normal or not. For more detail, refer to chapter 2.9 Diagnosis Function.

2.5.4 Modbus Client Service

Modbus protocol is specified open protocol used between client-server, which executes reading/writing data according to function code. Communication between devices that use Modbus protocol uses Client-server function in which only one client processes the data.

2.5.4.1 Channel setting

Cnet I/F module is available to define driver type for P2P service about each channel. However, active mode in the standard settings should be set as "Use P2P settings".

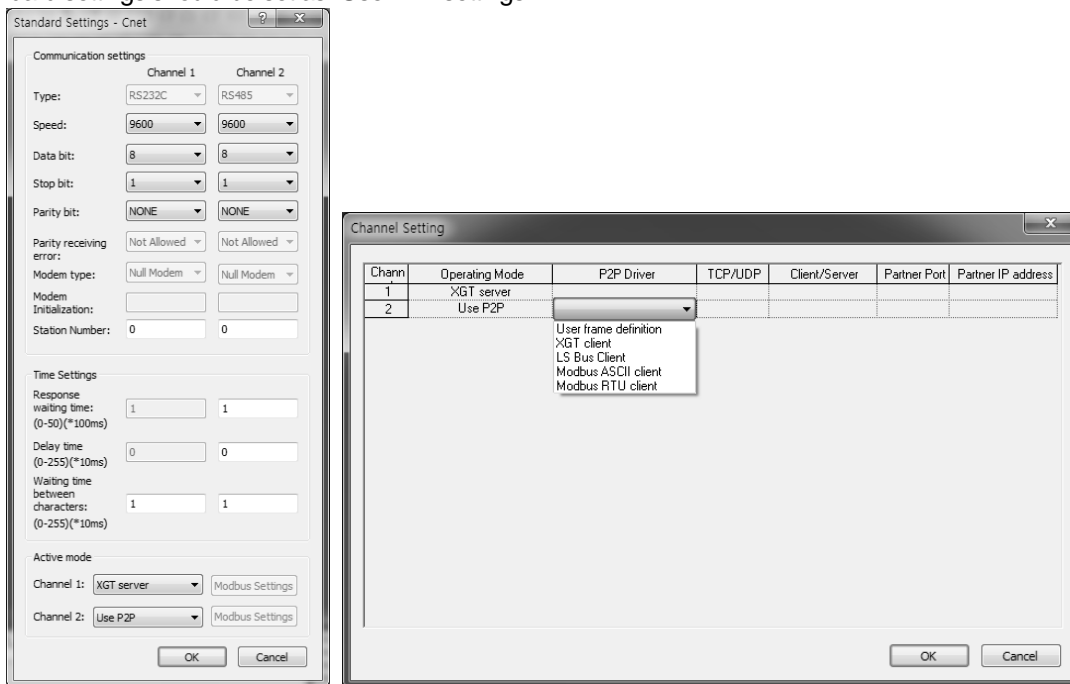





2.5.4.2 P2P block setting

There are two commands; Write (writes memory of self station to destination station's memory area) and Read (reads memory of destination memory and saves it in the memory area of self station)

Setting methods of both RTU and ASCII clients are same.

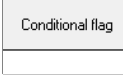
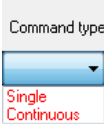
Index	Ch	Driver Setting	P2P function	Conditional flag	Command type	Data type	No. of variables	Data size	Destination station	Destination station number	Frame	Setting
0	2	Modbus RTU client					1		<input checked="" type="checkbox"/>	0		Setting
	①		②	③	④	⑤	⑥	⑦	⑧			⑨

No.	Type	Block type	Meaning
1	Channel		Driver name changes according to driver set in the P2P Driver.
2	P2P function		1. Read : when reading the destination station's memory 2. Write: when writing self-station's memory to destination station's memory.

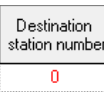
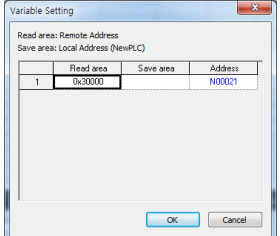
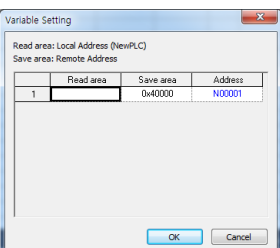
No.	Type	Block type	Meaning
3	Conditional flag		<ol style="list-style-type: none"> Determines when Cent sends frame In case of XBC type Ex. : F90(20ms flag), M01 In case of XEC type Ex. : _T20MS(20ms flag), %MX01
4	Command type		<ol style="list-style-type: none"> single: When reading/writing max. 4 memory areas. (Ex. : M01, M10, M20, M30) continuous: When reading/writing continuous memory areas. (Ex. : M01~M10)
5	Data type		Data type can be bit or word.
6	Data size		<p>▷ Determines size of data to communicate and it is activated when command type is continuous.</p> <ol style="list-style-type: none"> when P2P function is Read <ol style="list-style-type: none"> Modbus RTU client <ol style="list-style-type: none"> Bit type : 1~2000 Word type : 1~125 Modbus ASCII client <ol style="list-style-type: none"> Bit type : 1~976 Word type : 1~61 when P2P function is Write <ol style="list-style-type: none"> Modbus RTU client <ol style="list-style-type: none"> Bit type : 1~1968 Word type : 1~123 Modbus ASCII client <ol style="list-style-type: none"> Bit type : 1~944 Word type : 1~125
7	Destination station		<ol style="list-style-type: none"> It is checked automatically. In case that the user doesn't want to use relevant block, remove the check indication. Then that block doesn't work.
8	Destination station number		<ol style="list-style-type: none"> Destination station number, setting range is 0~31.
9	Setting		<p>▶ When P2P function is Read</p> <ol style="list-style-type: none"> Read area: device area of server <ol style="list-style-type: none"> Bit: bit input (0x10000), bit output (0x00000) Word: word input (0x30000), word output (0x40000) Save area: client's device to save the data
			<p>▶ When P2P function is Write</p> <ol style="list-style-type: none"> Read area: device area of self station Save area: server's device area to save the data <ol style="list-style-type: none"> Bit: bit input (0x10000), bit output (0x00000) Word: word input (0x30000), word output (0x40000)

2.5.4.3 Writing parameter

After P2P block setting is completed, download setting parameter to CPU.

Select [Online] – [Connect] – [Write], and click OK in parameter download window, and then it will be downloaded.

After download, the parameter is applied immediately. If you check 'Set up with Link Enable', Link Enable can be applied with writing P2P/HS parameters at the same time.

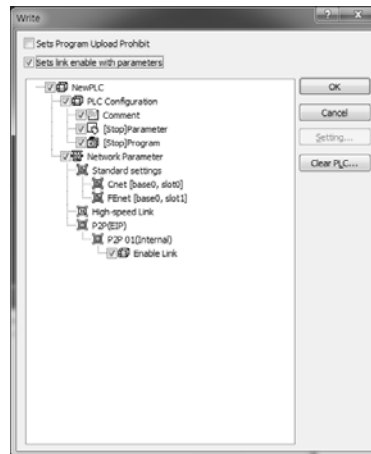

2.5.4.4 Enabling link

After setting P2P parameter and downloading the parameter to PLC CPU, enable P2P service. If parameter is downloaded but P2P(EIP) is not enabled, the P2P block is not operated. In order to enable P2P(EIP), Select [Online] – [Communication module setting] – [Enable Link], and click P2P(EIP) number which you want to operate and then click Write button. The P2P(EIP) is enabled.

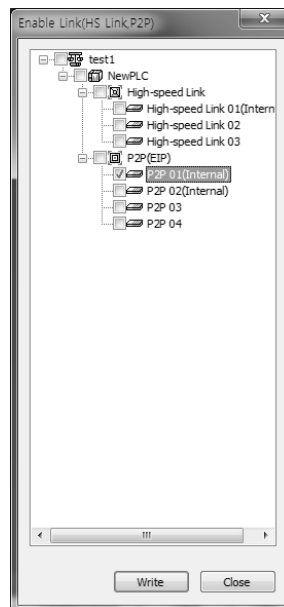

2.5.4.5 Diagnosis service

In order to check the setting parameter operates normally, diagnosis service is available.

Select [Online] – [Communication module setting] – [System Diagnosis]. Click the module and then click mouse right-button. If you select Frame Monitor or Status by Service, it can be checked whether the communication is normal or not. For more detail, refer to chapter 2.9 Diagnosis Function.

2.5.5 User-defined Communication Service

There are many protocols according to producer of communication device and it is impossible to supports diverse protocols. So if the user defines protocols and writes program, Cnet I/F module allows the communication between different devices according to defined protocol. In order to communicate with device which doesn't use specific protocols (XGT protocol, Modbus protocol), the user can directly define protocol used in the device the user want to communicate and communicate. At this time, the user should define TX and RX frame so that it meets partner device's protocol.

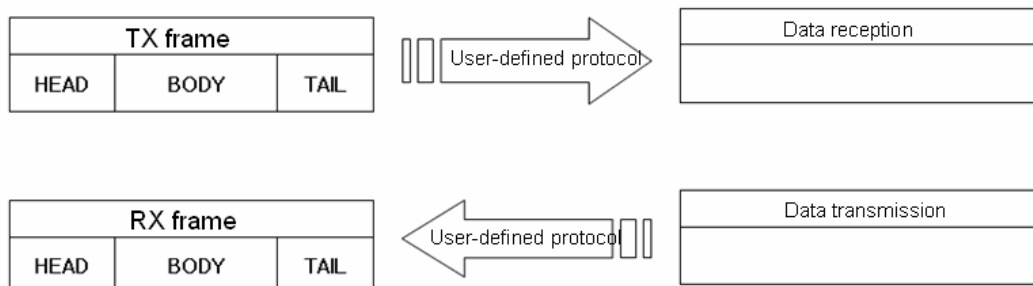

2.5.5.1 Structure of user-defined frame

When writing frame by user definition frame, frame is divided into HEAD, TAIL and BODY generally and each HEAD, TAIL and BODY is divided into segment. Total size of one frame should be less than 1024 byte.

Frame		
HEAD	BODY	TAIL
Segment 1	Segment 1	Segment 1
Segment 2	Segment 2	Segment 2
Segment 3	Segment 3	Segment 3
Segment N	Segment N	Segment N

2.5.5.1.1 Structure of HEAD

Input type of segment for HEAD is divided into numerical constant and string constant.

In case of numerical constant, it means HEX value and in case of string constant, it means ASCII value.

2.5.5.1.2 Structure of TAIL

Input type of segment for HEAD is divided into numerical constant, string constant and BCC which check frame error. Meaning of numerical constant and string constant is same with HEAD's. BCC is segment used for checking TRX frame error, only one can be set in the TAIL.

2.5.5.1.2.1 BCC error check

When BCC is applied, calculation about TRX frame is executed and if calculation is different, relevant frame is ignored to improve the reliability of communication. Calculation methods about each BCC are as follows.

Classification	BCC method	Contents description
General method checking error	Byte SUM	Adds designated data as 1 byte unit and uses lower byte value
	Word SUM	Adds designated data as 1 word unit and uses lower word value
	Byte XOR	Executes Exclusive OR calculation about designated data as 1 byte unit and uses lower byte
	7bit SUM	Uses result value of byte sum except the most significant bit
	7bit XOR	Uses result value of byte XOR except the most significant bit
	7bit SUM#1	If result of 7 bit SUM is less than 20 _H , it adds 20 _H .
	Byte SUM 2'S COMP	Takes 2's complement about byte sum result
	Byte SUM 1'S COMP	Takes 1's complement about byte sum result
	CRC 16	16 bit error detection method
	CRC 16 IBM	16 bit IBM CRC error detection method
	CRC 16 CCITT	16 bit CCITT CRC error detection method
MODBUS LRC	MODBUS LRC error detection method	
Method checking error for dedicated communication	LS CRC	Error detection method used for LS ELECTRIC PLC
	DLE AB	Error detection method used for DF1 Protocol of Allen Bradley
	DLE SIEMENS	Error detection method used for Siemens 3964R communication

When setting BCC, in case of general method, the user need not set BCC setting range and indication method and in case of dedicated method, the user should set BCC setting range and indication method.

Item		Contents
Start position	Start area	Determines where BCC calculation starts from among HEAD/BODY/TAIL
	Segment	Determines segment location to start BCC calculation in HEAD/BODY/TAIL. 0 means first segment will be included in the BCC calculation
End position	Before BCC	Included from start position to before BCC
	End of area	Included from start position to end of designated area
	Settings	Included from start position to designated area segment
ASCII conversion		Converts result value, its size will be double
Initial value 0		Designates BCC initial value as 0. If there is no designation, initial value is FF _H .

2.5.5.1.3 Structure of BODY

Input type of segment which composes BODY is different according to reception and transmission.

In case of transmission, they are divided into string constant, numerical constant and fix sized variable. Meaning of string constant and numerical constant is same with HEAD's.

2.5.5.1.3.1 Variable sized variable (in RX frame)

Part where size and contents changes are defined as variable sized variable. Variable sized variable can be set in the BODY and after variable sized variable, the user can't add segment. When using variable sized variable, there should be one among HEAD, TAIL. If the user registers variable sized variable without HEAD, TAIL, when receiving frame, there may be error according to communication status. For reliability of communication, register one among HEAD, TAIL. (In case of Variable sized variable of TX frame, the size is designated in P2P Block setting, so the function and characteristic is same with Fix sized variable of RX frame.)

2.5.5.1.3.2 Fix sized variable (in RX frame)

Frame part where size is fixed but contents changes are defined as Fix sized variable. It can be set in the BODY. In case of Fix sized variable, the user can register up to 4.

TRX frame standard for user - defined communication of XGB Cnet I/F module is as follows.

Group	Frame	Segment	Reference
TX frame	HEAD	Numerical constant	Max. 10 byte
		String constant	Max. 10 byte
	TAIL	Numerical constant	Max. 10 byte
		String constant	Max. 10 byte
		BCC	Only one BCC applicable
	BODY	Numerical constant	Max. 10 byte
		String constant	Max. 10 byte
Variable sized variable		Available up to 4	
RX frame	HEAD	Numerical constant	Max. 10 byte
		String constant	Max. 10 byte
	TAIL	Numerical constant	Max. 10 byte
		String constant	Max. 10 byte
		BCC	Only one BCC applicable
	BODY	Numerical constant	Max. 10 byte
		String constant	Max. 10 byte
		Fix sized variable	Available up to 4 Fix sized variable 3, variable sized variable 1 are available
		Variable sized variable	Only one variable sized variable available After variable sized variable, adding segment is impossible

2.5.5.2 Channel setting

Cnet I/F module is available to define driver type for P2P service about each channel. However, active mode in the standard settings should be set as "Use P2P settings".

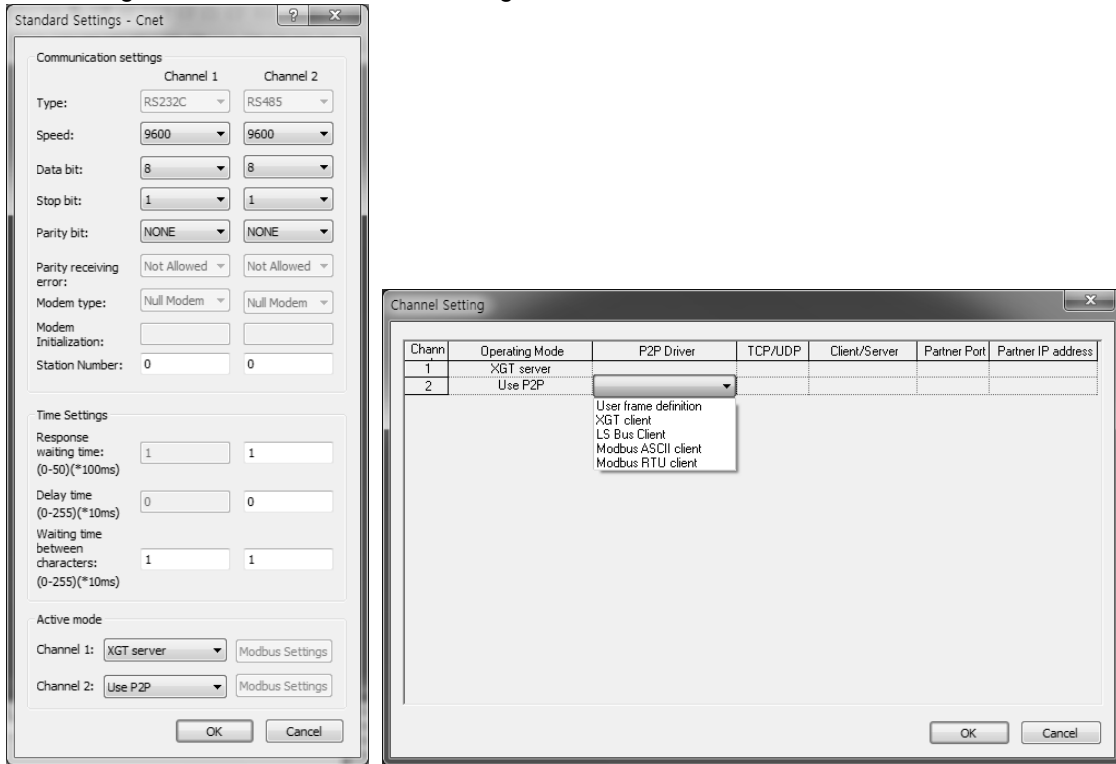

2.5.5.3 Set-up transmission frame

Frame is composed of HEAD indicating start, TAIL indicating end and BODY which is data area. How to write transmission frame is as follows.

Sequence	Setting contents	Setting method
1	Writing user frame definition	
		<ol style="list-style-type: none"> 1. Select User frame definition. 2. Click right button of mouse and click Add Group
2	Creating frame	
		<ol style="list-style-type: none"> 1. Group name is name of frame for user to write. 2. Select Transmission as frame type.

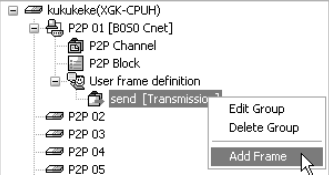
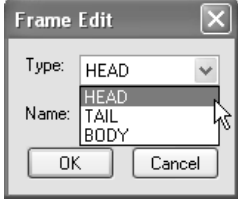
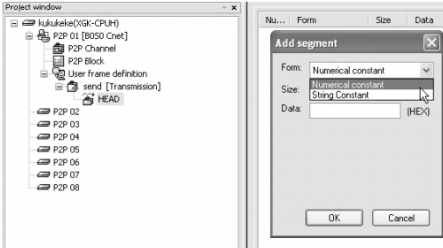
Sequence	Setting contents	Setting method
3	Creating frame	
4	Creating HEAD, TAIL, BODY	
5	HEAD registration	

1. Check creation of frame.
2. Select frame name and click right button of mouse.
3. Click Add Frame to create HEAD, TAIL and BODY.
4. Group Edit: when changing frame name.
5. Delete Group: when deleting frame.



1. After clicking Add Frame, select type of frame.
2. type: HEAD, TAIL, BODY
3. Select HEAD.
4. To create TAIL, BODY, repeat step 3.
5. Name of frame edit window is activated when frame type is BODY.
6. Available to creating many BODYs with different name.

1. Double-click HEAD. Then edit window is created.
 2. Double-click edit window or click right button and select Add segment.
 3. Select Form.
 - 1) Numerical constant
 - (1) Defines numerical constant among frame
 - (2) Data value is always Hex (Hexadecimal)
 - 2) String constant
 - (1) Registers string constant among frame
 - (2) Data value is always ASCII
 4. Input value into Data.

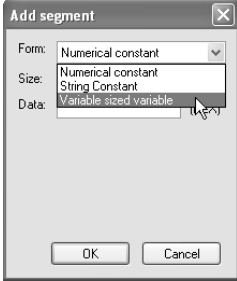
Ex.) Form: Numerical constant
Data: 5(ENQ)
- * When clicking the right button on the created segment, edit, deletion, insertion, copy, etc. are available.

Sequence	Setting contents	Setting method
6	TAIL registration	1. If double-click TAIL, edit window shows. 2. Setting method is same with step 5. 3. Add BCC is activated after inserting segment.
	BODY registration	
7		1. Double-click BODY and select data form. 1) Numerical constant and string constant are same as described above. 2) Variable sized variable (1) used when frame length change (2) available to insert up to 4 for one body (3) 'Assign memory' is checked automatically (4) Control by byte unit 3) Conversion ▶ Hex To ASCII: converts the data red from PLC into ASCII and configures transmission frame ▶ ASCII To Hex: converts the data red from PLC into Hex and configures transmission frame 4) Swap ▶ 2 Byte swap: 2 byte swap of data (ex.: 0x1234->0x3412) ▶ 4 Byte swap: 4 byte swap of data (ex.: 0x12345678->0x78564321) ▶ 8 Byte swap: 8 byte swap of data

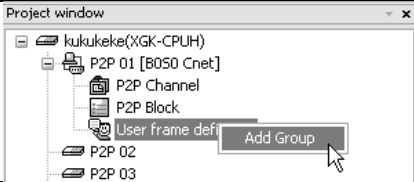
2.5.5.4 Set-up reception frame

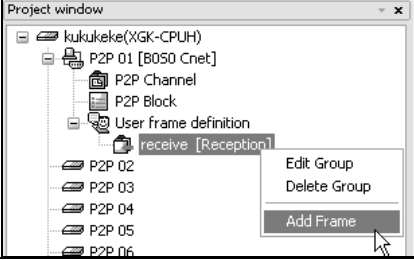
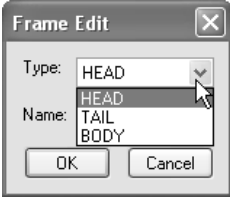
Sequence	Setting method	Setting method
1	Writing user-defined frame	
		<ol style="list-style-type: none"> 1. Select User frame definition. 2. Click the right button of mouse and select Add Group.
2	Creating frame	
		<ol style="list-style-type: none"> 1. Group name is name of frame for user to write. 2. Select Reception as frame type.
3	Creating frame	
		<ol style="list-style-type: none"> 1. Check creation of frame. 2. Select frame name and click right button of mouse. 3. Click Add Frame to create HEAD, TAIL and BODY. 4. Group Edit: when changing frame name. 5. Delete Group: when deleting frame.
4	Creating HEAD, TAIL, BODY	
		<ol style="list-style-type: none"> 1. After clicking Add Frame, select type of frame. 2. type: HEAD, TAIL, BODY 3. Select HEAD. 4. To create TAIL, BODY, repeat step 3. 5. Name of frame edit window is activated when frame type is BODY. 6. Available to creating many BODYs with different name.

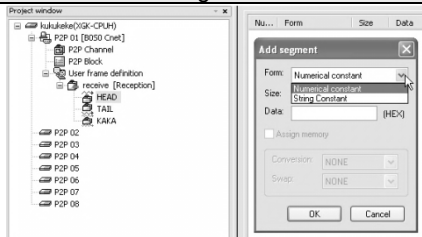
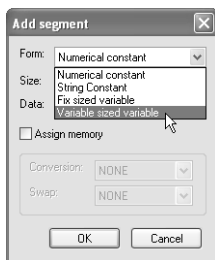
Sequence	Setting method	Setting method
5	HEAD registration	
		<ol style="list-style-type: none"> 1. Double-click HEAD. Then edit window is created. 2. Double-click edit window or click right button and select Add segment. 3. Select Form. <ol style="list-style-type: none"> 1) Meaning of each form is same as described in the transmission. 4. Input value into Data.
6	TAIL registration	<ol style="list-style-type: none"> 1. If double-click TAIL, edit window shows. 2. Setting method is same with step 5. 3. Add BCC is activated after inserting segment.
7	BODY registration	
		<ol style="list-style-type: none"> 1. Double-click BODY and select data form. <ol style="list-style-type: none"> 1) Numerical constant and string constant are same as described above. 2) Variable sized variable <ol style="list-style-type: none"> (1) used when frame length changes (2) Available to insert only one variable sized variable and it is impossible to add segment after variable sized variable (3) When checking [Assign memory], it is available to save in the PLC memory (4) Control by byte unit 3) Fix sized variable <ol style="list-style-type: none"> (1) Used when frame size is fixed. (2) available to insert up to 4 for one body (3) When checking [Assign memory], it is available to save in the PLC memory 4) Assign memory: when setting the device area of PLC to save data. 5) Conversion <ul style="list-style-type: none"> ▶ Hex To ASCII: converts the data received into ASCII and configures reception frame ▶ ASCII To Hex: converts the data received into Hex and configures reception frame 6) Swap <ul style="list-style-type: none"> ▶ 2 Byte swap: 2 byte swap of data (ex.: 0x1234->0x3412) ▶ 4 Byte swap: 4 byte swap of data (ex.: 0x12345678->0x78564321) ▶ 8 Byte swap: 8 byte swap of data

2.5.5.5 Setting parameter

To send and receive the user definition frame of XG5000, the user should set the parameter by P2P block. How to set the P2P block is as follows.

Index	Ch	Driver Setting	P2P function	Conditional flag	Command type	Data type	No. of variables	Data size	Destination station	Destination station number	Frame	Setting
0	2	User frame definition										Setting
	①		②	③							④	⑤

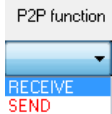
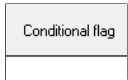
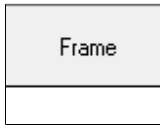
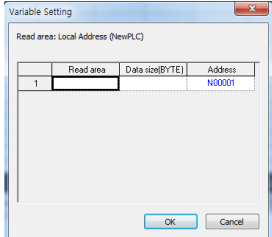
No.	Type	Block type	Meaning
1	Channel		Driver name changes according to driver set in the P2P Driver.
2	P2P Function		<ol style="list-style-type: none"> 1. Receive: used when receiving the frame written according to partner's protocol 2. Send: used when sending the frame written according to partner's protocol
3	Conditional flag		<ol style="list-style-type: none"> 1. Determines when Cent sends frame 2. It is activated when P2P function is [Send]. 3. In case of XBC type Ex.: F90(20ms flag), M01 4. In case of XEC type Ex.: _T20MS(20ms flag), %MX01
4	Frame		1. In case of selecting [SEND] in the P2P function, select body of transmission frame written in the user definition frame.
			1. In case of selecting [RECEIVE] in the P2P function, select body of reception frame written in the user definition frame.
5	Setting		<ol style="list-style-type: none"> 1. Setting is available when [Assign memory] of Fix sized variable and variable sized variable is checked. 2. Save area: start address to save the data received from destination station.

2.5.5.6 Writing parameter

After P2P block setting is completed, download setting parameter to CPU.

Select [Online] – [Connect] – [Write], and click OK in parameter download window, and then it will be downloaded.

After download, the parameter is applied immediately. If you check 'Set up with Link Enable', Link Enable can be applied with writing P2P/HS parameters at the same time.

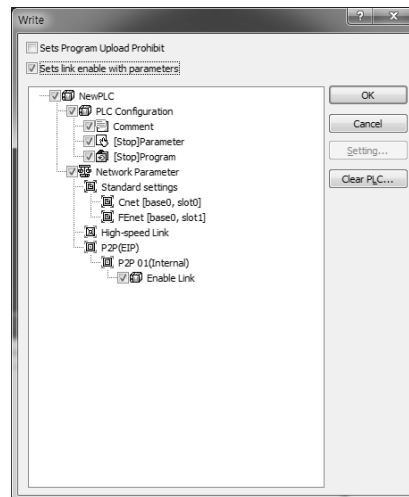

2.5.5.7 Enabling link

After setting P2P parameter and downloading the parameter to PLC CPU, enable P2P service. If parameter is downloaded but P2P(EIP) is not enabled, the P2P block is not operated.

In order to enable P2P(EIP), Select [Online] – [Communication module setting] – [Enable Link], and click P2P(EIP) number which you want to operate and then click Write button. The P2P(EIP) is enabled.

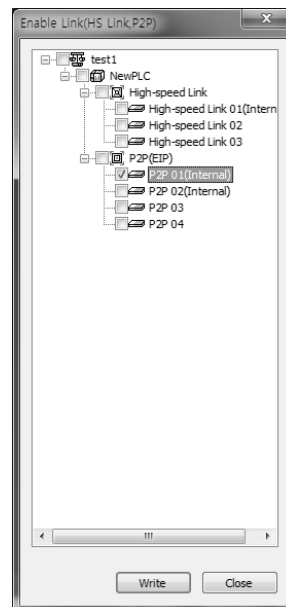

2.5.5.8 Diagnosis service

In order to check the setting parameter operates normally, diagnosis service is available.

Select [Online] – [Communication module setting] – [System Diagnosis]. Click the module and then click mouse right-button. If you select Frame Monitor or Status by Service, it can be checked whether the communication is normal or not. For more detail, refer to chapter 2.9 Diagnosis Function.

2.5.6 LS Bus Client

LS Bus Protocol communication is function executing communication between XGB Cnet and LS Inverter. User can configure LS Bus communication system between our products without special setting by using reading/writing data of internal device area and monitoring function

2.5.6.1 Channel setting

Cnet I/F module is available to define driver type for P2P service about each channel. However, active mode in the standard settings should be set as "Use P2P settings". P2P setting according to active mode is as follows.

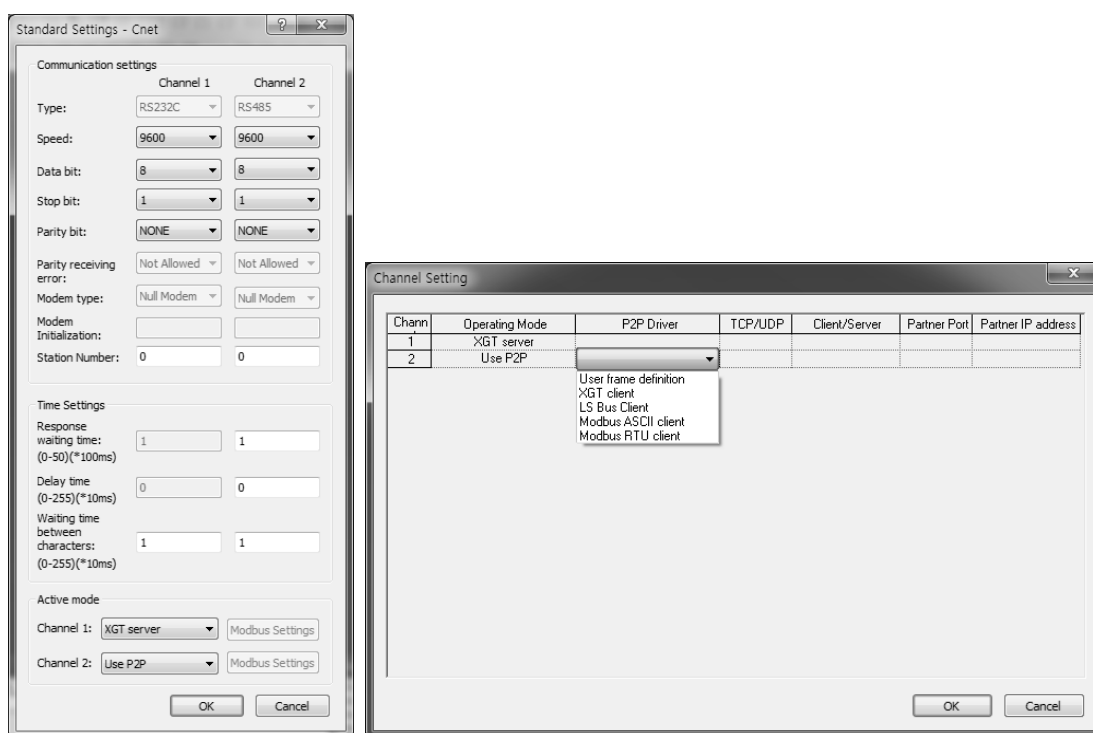



2.5.6.2 P2P block setting

If selecting P2P block in the P2P parameter setting window, P2P block setting window shows.

Block setting window is same according to protocol and activated area is different P2P. Each of items means as follow.

Index	Ch	Driver Setting	P2P function	Conditional flag	Command type	Data type	No. of variables	Data size	Destination station	Destination station number	Frame	Setting
0	2	LS Bus Client			Continuous	WORD	1		<input checked="" type="checkbox"/>	0		Setting
	①		②	③				④	⑤	⑥		⑦

No.	Type	Block form	Contents
1	Channel		Driver name changes according to driver set in the P2P Driver.
2	P2P function		1. Read : when reading the destination station's memory 2. Write: when writing self-station's memory to destination station's memory.
3	Conditional flag		1. Determines when Cnet sends request frame 2. In case of XBC type Ex. : F90(20ms flag), M01 3. In case of XEC type Ex. : _T20MS(20ms flag), %MX01

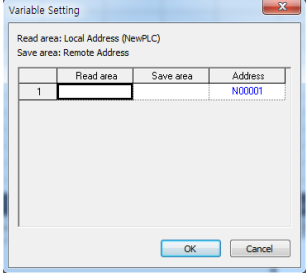
No.	Type	Block form	Contents
4	Data size		<ol style="list-style-type: none"> 1. This is activated when command type is continuous. 2. When data type is 1 word, available max. no. is 8 word
5	Destination station		<ol style="list-style-type: none"> 1. Check: Specify the destination station
6	Destination station number		<ol style="list-style-type: none"> 1. Destination station number, setting range is 0~63.
7	Setting		<ol style="list-style-type: none"> 1. When P2P function is Read <ol style="list-style-type: none"> 1)Read area : device area of server 2)Save area : client's device to save the data from server 2. When P2P function is Write <ol style="list-style-type: none"> 1)Read area : device area of client 2)Save area : Server's device area to save client's data

2.5.6.3 Writing parameter

After P2P block setting is completed, download setting parameter to CPU.

Select [Online] – [Connect] – [Write], and click OK in parameter download window, and then it will be downloaded.

After download, the parameter is applied immediately. If you check 'Set up with Link Enable', Link Enable can be applied with writing P2P/HS parameters at the same time.

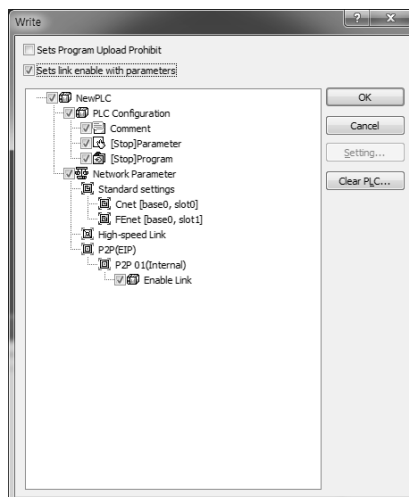

2.5.6.4 Enabling link

After setting P2P parameter and downloading the parameter to PLC CPU, enable P2P service. If parameter is downloaded but P2P(EIP) is not enabled, the P2P block is not operated. In order to enable P2P(EIP), Select [Online] – [Communication module setting] – [Enable Link], and click P2P(EIP) number which you want to operate and then click Write button. The P2P(EIP) is enabled.

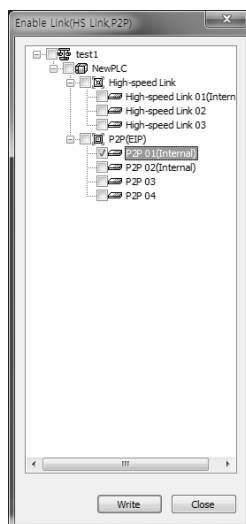

2.5.6.5 Diagnosis service

In order to check the setting parameter operates normally, diagnosis service is available.

Select [Online] – [Communication module setting] – [System Diagnosis]. Click the module and then click mouse right-button. If you select Frame Monitor or Status by Service, it can be checked whether the communication is normal or not. For more detail, refer to chapter 2.9 Diagnosis Function.

2.6 XGT Dedicated Protocol

XGT series dedicated protocol communication is function executing communication by our dedicated protocol. User can configure the intended communication system between our products without special setting by using reading/writing data of internal device area and monitoring function.

Dedicated protocol function supported by XGB is as follows.

- Device individual/continuous read
- Device individual/continuous write
- Monitor variable registration
- Monitor execution
- 1:1 connection (Our link) system configuration

Note

- XGB's built-in communication function supports Cnet communication without any separate Cnet I/F module. It must be used under the following instructions.
- Channel 1 of XGB's main unit supports 1:1 communication only. For 1:N system having master-slave Format, use RS-485 communication in channel 2 or XGB's main unit with XGL-C41A module connected. XGL-C41A module supports RS-422/485 protocol.
- RS-232C communication cable for XGB's main unit is different from RS-232C cable for XG5000 (XG-PD) in pin arrangement and from the cable for Cnet I/F module, too. The cable can't be used without any treatment. For the detailed wiring method, refer to configuration of respective communication.
- It's possible to set baud rate type and station No. in XG5000 (XG-PD).

2.6.1 XGT Dedicated Protocol

2.6.1.1 Frame structure

2.6.1.1.1 Basic format

2.6.1.1.1.1 Request frame (external communication device → XGB)

Header (ENQ)	Station number	Command	Command type	Structurized data area	Tail (EOT)	Frame check (BCC)
-----------------	-------------------	---------	-----------------	------------------------	---------------	----------------------

2.6.1.1.1.2 ACK response frame (XGB → external communication device, when receiving data normally)

Header (ACK)	Station number	Command	Command type	Structurized data area or Null code	Tail (ETX)	Frame check (BCC)
-----------------	-------------------	---------	-----------------	--	---------------	----------------------

2.6.1.1.1.3 NAK response frame (XGB → Cnet I/F module → external communication device when receiving data abnormally)

Header	Station	Command	Command	Error code (ASCII 4 Byte)	Tail	Frame check
--------	---------	---------	---------	-----------------------------	------	-------------

(NAK)	number		type		(ETX)	(BCC)
-------	--------	--	------	--	-------	-------

Note

- 1) The numerical data of all frames are ASCII codes equal to hexadecimal value, if there's no clear statement. The terms in hexadecimal are as follows.
 - Station No.
 - When the main command is R(r) or W (w) and the command type is numerical (means a data type)
 - All of the terms indicating size of all data in the Formatted data area.
 - Monitoring registration and command registration number of execution commands.
 - All contents of data
- 2) If it is hexadecimal, H is attached in front of the number of frames like H01, H12345, H34, H12, and H89AB.
- 3) Available frame length is maximum 256 bytes.
- 4) Used control codes are as follows.

Codes	Hex value	Name	Contents
ENQ	H05	Enquire	Request frame initial code
ACK	H06	Acknowledge	ACK response frame initial code
NAK	H15	Not Acknowledge	NAK response frame initial code
EOT	H04	End of Text	Request frame ending ASCII code
ETX	H03	End Text	Response frame ending ASCII code

- 5) If the command is small letter (r), BCC value is added in check frame. The other side capital letter (R), BCC value is not added in check frame.

2.6.1.1.2 Command frame sequence

2.6.1.1.2.1 Sequence of command request frame

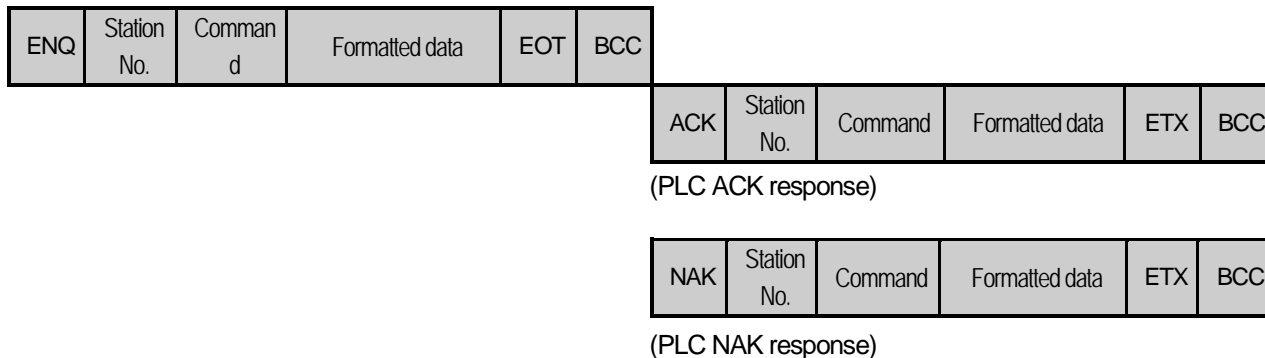

2.6.1.1.2.2 List of commands

List of commands used in dedication communication is as shown below.

Classification Items		Command				Treatment
		Main command		Command type		
		Code	ASCII code	Code	ASCII code	
Reading device	Individual	r(R)	H72 (H52)	SS	5353	Reads direct variable of Bit, Byte, Word, Dword, Lword type.
	Continuous	r(R)	H72 (H52)	SB	5342	Read direct variable of Byte, Word, Dword, Lword with block unit (Bit continuous read is not allowed)
Writing device	Individual	w(W)	H77 (H57)	SS	5353	Write data of Bit, Byte, Word, Dword, Lword at direct variable
	Continuous	w(W)	H77 (H57)	SB	5342	Write data of Byte, Word, Dword, Lword at direct variable with block unit (Bit continuous read is not allowed)

Classification Item		Command			Treatment
		Main command		Register No	
		Code	ASCII code		
Monitoring variable register	x(X)	H78 (H58)	H00~H0F		Register device to monitor.
Execution of monitoring	y(Y)	H79 (H59)	H00~H0F		Execute registered device to monitor.

Note

- It identifies capitals or small letters for main commands, but not for the others.

2.6.1.1.3 Data type

It's possible to read and write device in built-in communication. When device is used, be aware of data type.

2.6.1.1.3.1 Available types of device (XBC type)

Device	Range	Size (Word)	Remark
P	P0 – P2047	2048	Read/Write/Monitor available
M	M0 – M2047	2048	Read/Write/Monitor available
K	K0 – K8191	8192	Read/Write/Monitor available
F	F0 – F2047	2048	Read/Monitor available
T	T0 – T2047	2048	Read/Write/Monitor available
C	C0 – C2047	2048	Read/Write/Monitor available
L	L0 – L4095	4096	Read/Write/Monitor available
N	N0 – N10239	10240	Read/Monitor available
D	D0 – D19999	20000	Read/Write/Monitor available
U	U00.00 – U0B.31	384	Read/Write/Monitor available
Z	Z0 – Z127	128	Read/Write/Monitor available
R	R0 – R16383	16384	Read/Write/Monitor available

2.6.1.1.3.2 Available types of device (XEC type)

Device	Range	Size (Word)	Remark
I	%IW0.0.0 ~ %IW15.15.3	1024	Read/Write/Monitor available
Q	%QW0.0.0 ~ %QW15.15.3	1024	Read/Write/Monitor available
M	%MW0 ~ %MW16383	16384	Read/Write/Monitor available
W	%WW0 ~ %WW32767	32768	Read/Monitor available
R	%RW0 ~ %RW16383	16384	Read/Write/Monitor available

When device is designated, attach '%' (25H) in front of the marking characters.

('%' is stands for starting of device.)

Data type	Marking characters	Examples
Bit	X(58h)	%PX000,%MX000,%LX000,%KX000,%CX000,%TX000,%FX000, %IX0.0.0,%QX0.0.0,%UX00.00.0, etc
Byte	B(42h)	%PB000,%MB000,%LB000,%KB000,%CB000,%TB000,%FB000, %IB0.0.0,%QB0.0.0, etc
Word	W(57h)	%PW000,%MW000,%LW000,%KW000,%CW000,%TW000,%FW000, %DW000,%IW0.0.0,%QW0.0.0,%MW0,%RW0,%WW0,%UW00.00, etc
Dword	D(44h)	%PD000,%MD000,%LD000,%KD000,%CD000,%TD000, %FD000,%DD000,%ID0.0.0,%QD0.0.0,%MD0,%RD0,%WD0, etc
Lword	L(4Ch)	%PL000,%ML000,%LL000,%KL000,%CL000,%TL000, %FL000,%DL000,%IL0.0.0,%QL0.0.0,%ML0,%RL0,%WL0, etc

Note

- In case of U device, it will be available only for operation as server.
- Timer/Counter used in bit command means contact point values. (word command means current values.)
- Data register (D) can use only word or byte commands.
- In byte type commands, address is doubled. For example, D1234 is addressed to '%DW1234' in word type, and is addressed to '%DB2468' in byte type.

2.6.1.1.4 Error codes

Error code is displayed as hex 2 byte (4 byte as ASCII code). The user can see error by frame monitor and in case of viewing by ASCII, the user can see the following error code.

Error code	Error type	Error details and causes	Example
0003	Number of blocks exceeded	Number of blocks exceeds 16 at Individual Read/Write Request	01rSS1105%MW10...
0004	Variable length error	Variable Length exceeds the max. size of 16	01rSS010D%MW100000000000 ..
0007	Data type error	Other data type than X,B,W,D,L received	01rSS0105%MK10
0011	Data error	Data length area information incorrect	01rSB05%MW10%4
		In case % is unavailable to start with	01rSS0105\$MW10
		Variable's area value wrong	01rSS0105%MW^&
		Other value is written for Bit Write than 00 or 01	01wSS0105%MX1011
0090	Monitor execution error	Unregistered monitor execution requested	
0190	Monitor execution error	Reg. No. range exceeded	
0290	Monitor reg. Error	Reg. No. range exceeded	
1132	Device memory error	Other letter than applicable device is input	
1232	Data size error	Request exceeds the max range of 60 Words to read or write at a time.	01wSB05%MW1040AA5512,..
1234	Extra frame error	Unnecessary details exist as added.	01rSS0105%MW10000
1332	Data type discordant	All the blocks shall be requested of the identical data type in the case of Individual Read/Write	01rSS0205%MW1005%MB10
1432	Data value error	Data value unavailable to convert to Hex	01wSS0105%MW10AA%5
7132	Variable request area exceeded	Request exceeds the area each device supports.	01rSS0108%MWFFFFFF

2.6.2 Detail of instruction

1) Individual reading of device (R(r)SS)

This is a function that reads PLC device specified in accord with memory data type. Separate device memory can be read up to 16 at a time.

● PC request format

Format name	Header	Station No.	Command	Command type	Number of blocks	Device length	Device name	Tail	Frame check
Ex. of frame	ENQ	H20	R(r)	SS	H01	H06	%MW100		EOT	BCC
ASCII value	H05	H3230	H52(72)	H5353	H3031	H3036	H254D57313030		H04	

1 block (setting can be repeated up to max. 16 blocks)

Item	Description
BCC	When command is lowercase(r), only one lower byte of the value resulted by adding 1 Byte each to ASCII values from ENQ to EOT is converted into ASCII and added to BCC. For example, the BCC of the above frame is gotten as below: $H05+H32+H30+H72+H53+H53+H30+H31+H30+H36+H25+H4D+H57+H31+H30+H30+H04 = H03A4$ Therefore BCC value is A4 (ASCII value : H4134).
Number of Blocks	This specifies how much of the blocks composed of "[device length][device name]" are in this request format. This can be set up to 16. Therefore, the value of [Number of blocks] must be set between H01(ASCII value:3031)-H10(ASCII value:3030).
Device length (Length of device name)	This indicates the number of name's characters that means device, which is allowable up to 16 characters. This value is one of ASCII converted from hex type, and the range is from H01(ASCII value:3031) to H10(ASCII value:3130). For example, if the device name is %MW0, it has 4 characters to be H04 as its length. If %MW000 characters to be H06.
Device name	Address to be actually read is entered. This must be ASCII value within 16 characters, and in this name, digits, upper/lower case, '%' is only allowable to be entered.

Note

- BCC value is low 1byte in the sum of each byte from ENQ to EOT.
- In case of making actual frame, 'H' is not attached. Because the number data of frame indicates hexadecimal.

● XGB response format (ACK response)

Format name	Header	Station No.	Command	Command type	Number of blocks	Number of data	data	Tail	Frame check
Ex. of frame	ACK	H20	R(r)	SS	H01	H02	HA9F3		ETX	BCC
ASCII value	H06	H3230	H52(72)	H5353	H3031	H3032	H41394633		H04	

1 block (max. 16 blocks possible)

Item	Description												
BCC	When command is lowercase(r), only one lower byte of the value resulted by adding 1 Byte each to ASCII values from ACK to ETX is converted into ASCII and added to BCC, and sent.												
Number of data	<p>Number of data means byte number of hex type, and is converted into ASCII. This number is determined according to data type (X,B,W) included in device name of computer request Format.</p> <ul style="list-style-type: none"> Number of data in accordance with its data type is as follows: <table border="1" style="margin-left: 40px;"> <thead> <tr> <th>Data type</th> <th>Available variable</th> <th>Number of data</th> </tr> </thead> <tbody> <tr> <td>Bit(X)</td> <td>%(P,M,L,K,F,T,C,D,R,I,Q,W)X</td> <td>1</td> </tr> <tr> <td>Byte(B)</td> <td>%(P,M,L,K,F,T,C,D,R,I,Q,W)B</td> <td>1</td> </tr> <tr> <td>Word(W)</td> <td>%(P,M,L,K,F,T,C,D,R,I,Q,W)W</td> <td>2</td> </tr> </tbody> </table> <p>※R area is supported at XBC-DXXXU</p>	Data type	Available variable	Number of data	Bit(X)	%(P,M,L,K,F,T,C,D,R,I,Q,W)X	1	Byte(B)	%(P,M,L,K,F,T,C,D,R,I,Q,W)B	1	Word(W)	%(P,M,L,K,F,T,C,D,R,I,Q,W)W	2
Data type	Available variable	Number of data											
Bit(X)	%(P,M,L,K,F,T,C,D,R,I,Q,W)X	1											
Byte(B)	%(P,M,L,K,F,T,C,D,R,I,Q,W)B	1											
Word(W)	%(P,M,L,K,F,T,C,D,R,I,Q,W)W	2											
Data	<ul style="list-style-type: none"> In data area, there are the values of hex data converted to ASCII code saved. 												

▪Example 1

The fact that number of data is H04 (ASCII code value:H3034) means that there is hex data of 4 bytes in data. Hex data of 4 bytes is converted into ASCII code in data.

▪Example 2

If number of data is H04 and the data is H12345678, ASCII code converted value of this is "31 32 33 34 35 36 37 38," and this contents is entered in data area. Name directly, highest value is entered first, lowest value last.

Note

- If data type is Bit, data read is indicated by bytes of hex. Namely, if Bit value is 0, it indicated by H00, and if 1, by H01.

- XGB response format (NCK response)

Format name	Header	Station No.	Command	Command type	Error code (Hex 2 Byte)	Tail	Frame check
Ex. of frame	NAK	H20	R(r)	SS	H1132	ETX	BCC
ASCII value	H15	H3230	H52(72)	H5353	H31313332	H03	

Item	Explanation
BCC	When command is lowercase(r), only one lower byte of the value resulted by adding 1 Byte each to ASCII values from NAK to ETX is converted into ASCII and added to BCC.
Error code	Hex and 2 bytes (ASCII code, 4 bytes) indicate error type. Refer to 10.1.4 XGT dedicated communication error codes and countermeasures.

Example

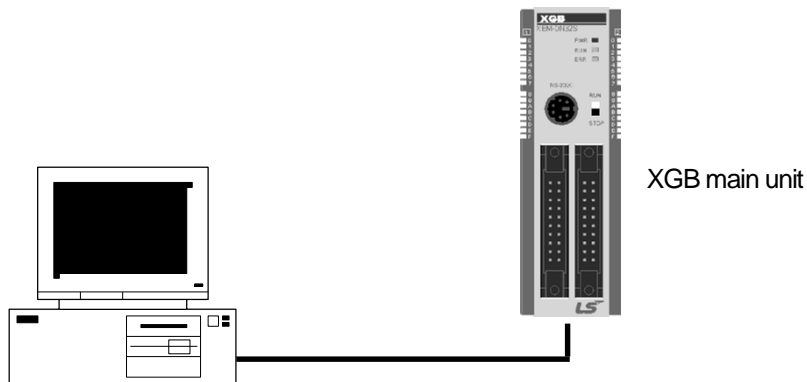

This example supposes when 1 WORD from M20 and 1 WORD from P001 address of station No.1 are read (At this time, it is supposed that H1234 is entered in M20, and data of H5678 is entered in P001.)

- PC request format (PC → XGB)

Format name	Header	Station No.	Command	Command type	Number of blocks	Variable length	Variable name	Device length	Variable name	Tail	Frame check
Ex. of frame	ENQ	H01	R(r)	SS	H02	H06	%MW020	H06	%PW001	EOT	BCC
ASCII value	H05	H3031	H52(72)	H5353	H3032	H3036	H254D57303230	H3036	H25505730303031	H04	

- For ACK response after execution of command (PC ← XGB)

Format name	Header	Station No.	Command	Command type	Number of blocks	Number of data	Data	Number of data	Data	Tail	Frame check
Ex. of frame	ACK	H01	R(r)	SS	H02	H02	H1234	H02	H5678	ETX	BCC
ASCII value	H06	H3031	H52(72)	H5353	H3032	H3032	H31323334	H3032	H35363738	H03	

- For NAK response after execution of command (PC ← XGB)

Format name	Header	Station No.	Command	Command type	Error code	Tail	Frame check
Ex. of frame	NAK	H01	R(r)	SS	Error code (2 Byte)	ETX	BCC
ASCII value	H15	H3031	H52(72)	H5353	Error code (4 Byte)	H03	

2.6.2.1 Direct variable continuous reading (R(r)SB)

This is a function that reads the PLC device memory directly specified in accord with memory data type. With this, data is read from specified address as much as specified continuously.

● PC request format

Format name	Header	Station No.	Command	Command type	Device length	Device	Number of data	Tail	Frame check
Ex. of frame	ENQ	H10	R(r)	SB	H06	%MW100	H05	EOT	BCC
ASCII value	H05	H3130	H52(72)	H5342	H3036	H254D5731 3030	H3035	H04	

Note
<ul style="list-style-type: none"> • Number of data specifies the number to read according to the type of data. Namely, if the data type of device is word and number is 5, it means that 5 words should be read. • In the number of data, you can use up to 60 words (120Byte). • Protocol of continuous reading of direct variable doesn't have number of blocks. • Bit device continuous reading is not supported.

Item	Description
BCC	When command is lowercase(r), only one lower byte of the value resulted by adding 1 Byte each to ASCII values from ENQ to EOT is converted into ASCII and added to BCC.
Device length (Length of device name)	This indicates the number of name's characters that means device, which is allowable up to 16 characters. This value is one of ASCII converted from hex type, and the range is from H01 (ASCII value:3031) to H10 (ASCII value:3130).
Device name	Address to be actually read is entered. This must be ASCII value within 16 characters, and in this name, digits, upper/lowercase, and '%' only are allowable to be entered.

● XGB response format (ACK response)

Format name	Header	Station No.	Command	Command type	Number of blocks	Number of data	data	Tail	Frame check
Ex. of frame	ACK	H10	R(r)	SB	H01	H02	H1122	ETX	BCC
ASCII value	H06	H3130	H52(72)	H5342	H3031	H3134	H31313232	H03	

Item	Description															
Number of data	It means byte number of hex type, and is converted into ASCII															
	<table border="1"> <thead> <tr> <th>Data type</th> <th>Available device</th> <th>Data size (Byte)</th> </tr> </thead> <tbody> <tr> <td>BYTE(B)</td> <td>%(P,M,L,K,F,T,C,D,R,I,Q,W)B</td> <td>1</td> </tr> <tr> <td>WORD(W)</td> <td>%(P,M,L,K,F,T,C,D,R,I,Q,W)W</td> <td>2</td> </tr> <tr> <td>DWord(D)</td> <td>%(P,M,L,K,F,T,C,D,R,I,Q,W)D</td> <td>4</td> </tr> <tr> <td>LWord(L)</td> <td>%(P,M,L,K,F,T,C,D,I,Q,W)L</td> <td>8</td> </tr> </tbody> </table>	Data type	Available device	Data size (Byte)	BYTE(B)	%(P,M,L,K,F,T,C,D,R,I,Q,W)B	1	WORD(W)	%(P,M,L,K,F,T,C,D,R,I,Q,W)W	2	DWord(D)	%(P,M,L,K,F,T,C,D,R,I,Q,W)D	4	LWord(L)	%(P,M,L,K,F,T,C,D,I,Q,W)L	8
	Data type	Available device	Data size (Byte)													
	BYTE(B)	%(P,M,L,K,F,T,C,D,R,I,Q,W)B	1													
	WORD(W)	%(P,M,L,K,F,T,C,D,R,I,Q,W)W	2													
DWord(D)	%(P,M,L,K,F,T,C,D,R,I,Q,W)D	4														
LWord(L)	%(P,M,L,K,F,T,C,D,I,Q,W)L	8														
※R area is supported at XBC-DXXXU																

▪Example 1

When memory type included in variable name of computer request Format is W (Word), and data number of computer request Format is 03, data number of PLC ACK response after execution of command is indicated by H06 (2*03 = 06 bytes)Byte and ASCII code value 3036 is entered in data area.

▪Example 2

In just above example, when data contents of 3 words are 1234, 5678, and 9ABC in order, actual ASCII code converted values are 31323334 35363738 39414243, and the contents are entered in data area.

● XGB response format (NAK response)

Format name	Header	Station No.	Command	Command type	Error code (Hex 2 Byte)	Tail	Frame check
Ex. of frame	NAK	H10	R(r)	SB	H1132	ETX	BCC
ASCII value	H15	H3130	H52(72)	H5342	H31313332	H03	

Item	Description
BCC	When command is lowercase(r), only one lower byte of the value resulted by adding 1 Byte each to ASCII values from NAK to ETX is converted into ASCII and added to BCC, and sent.
Error code	Hex and 2 bytes (ASCII code, 4 bytes) indicate error type. For the details, Refer to XGT dedicated communication error codes and countermeasures.

- Example

This example supposes that 2 WORDs from M000 of station No. 10 is read
(It supposes that M000 = H1234, M001 = H5678.)

- PC request format (PC → XGB)

Format name	Header	Station No.	Command	Command type	Device length	Device name	Number of data	Tail	Frame check
Frame (Example)	ENQ	H0A	R(r)	SB	H06	%MW000	H02	EOT	BCC
ASCII value	H05	H3041	H52(72)	H5342	H3036	H254D3030 30	H3032	H04	

- For ACK response after execution of command (PC ← XGB)

Format name	Header	Station No.	Command	Command type	Number of block	Number of data	Data	Tail	Frame check
Frame (Example)	ACK	H0A	R(r)	SB	H01	H04	12345678	ETX	BCC
ASCII value	H06	H3041	H52(72)	H5342	H3031	H3034	H3132333435363738	03	

- For NAK response after execution of command (PC ← XGB)

Format name	Header	Station No.	Command	Command type	Error code	Tail	BCC
Frame (Example)	NAK	H0A	R(r)	SB	Error code (2 Byte)	ETX	BCC
ASCII value	H15	H3041	H52(72)	H5342	Error code (4 Byte)	H03	

2.6.2.2 Individual writing of device (W(w)SS)

This is a function that writes the PLC device memory directly specified in accord with memory data type.

● PC request format

Format name	Header	Station No.	Command	Command type	Number of blocks	Device Length	Device Name	Data	Tail	Frame check
Frame(Example)	ENQ	H20	W(w)	SS	H01	H06	%MW100	H00E2		EOT	BCC
ASCII value	H05	H3230	H57(77)	H5353	H3031	H3036	H254D573130 30	H30304532		H04	

1 block (setting can be repeated up to max. 16 blocks)

Item	Description
BCC	When command is lowercase(r), only one lower byte of the value resulted by adding 1 Byte each to ASCII values from ENQ to EOT is converted into ASCII and added to BCC.
Number of blocks	This specifies how much of the blocks composed of "[device length][device name]" are in this request Format. This can be set up to 16. Therefore, the value of [Number of blocks] must be set between H01(ASCII value:3031)-H10 (ASCII value:3030).
Device Length (Name length of device)	This indicates the number of name's characters that means device, which is allowable up to 16 characters. This value is one of ASCII converted from hex type, and the range is from H01 (ASCII value: 3031) to H10 (ASCII value:3130).
device	Address to be actually read is entered. This must be ASCII value within 16 characters, and in this name, digits, upper/lower case, and '%' only is allowable to be entered.
Data	If the value to be written in %MW100 area is H A, the data Format must be H000A. If the value to be written in %MW100 area is H A, the data Format must be H000A. In data area, the ASCII value converted from hex data is entered.

▪Example 1

If type of data to be currently written is WORD, the data is H1234, ASCII code converted value of this is "31323334" and this content must be entered in data area. Namely, most significant value must be sent first, least significant value last.

Note

- Device data types of each block must be the same
- If data type is Bit, the data to be written is indicated by bytes of hex. Namely, if Bit value is 0, it must be indicated by H00 (3030), and if 1, by H01 (3031).

● XGB Response format (ACK response)

Format name	Header	Station No.	Command	Command type	Tail	Frame check
Frame (Example)	ACK	H20	W(w)	SS	ETX	BCC
ASCII value	H06	H3230	H57(77)	H5353	H03	

Item	Description
BCC	When command is lowercase (r), only one lower byte of the value resulted by adding 1 Byte each to ASCII values from ACK to ETX is converted into ASCII and added to BCC, and sent.

● XGB Response format (NAK response)

Format name	Header	Station No.	Command	Command type	Error code (Hex 2 Byte)	Tail	Frame check
Frame (Example)	NAK	H20	W(w)	SS	H4252	ETX	BCC
ASCII value	H15	H3230	H57(77)	H5353	H34323532	H03	

Item	Description
BCC	When command is lowercase(r), only one lower byte of the value resulted by adding 1 Byte each to ASCII values from NAK to ETX is converted into ASCII and added to BCC, and sent.
Error code	Hex and 2 bytes (ASCII code, 4 bytes) indicate error type. For the details, Refer to 10.1.4 XGT dedicated communication error codes and countermeasures.

● Example

This example supposes that "HFF" is written in M230 of station No. 1.

1) PC request format (PC → XGB)

Format name	Header	Station No.	Command	Command type	Number of blocks	Device Length	Device Name	Data	Tail	Frame check
Frame (Example)	ENQ	H01	W(w)	SS	H01	H06	%MW230	H00FF	EOT	BCC
ASCII value	H05	H3031	H57(77)	H5353	H3031	H3036	H254D573233 30	H30304646	H04	

2) For ACK response after execution of command (PC ← XGB)

Format name	Header	Station No.	Command	Command type	Tail	Frame check
Frame (Example)	ACK	H01	W(w)	SS	ETX	BCC
ASCII value	H06	H3031	H57(77)	H5353	H03	

3) For NAK response after execution of command (PC ← XGB)

Format name	Header	Station No.	Command	Command type	Error code	Tail	Frame check
Frame (Example)	NAK	H01	W(w)	SS	Error code (2 Byte)	ETX	BCC
ASCII value	H15	H3031	H57(77)	H5353	Error code (4 Byte)	H03	

2.6.2.3 Continuous writing of device (W(w)SB)

This is a function that directly specifies PLC device memory and continuously writes data from specified address as much as specified length.

● Request format

Format name	Header	Station No.	Command	Command type	Device Length	Device name	Number of data	Data	Tail	Frame check
Frame (Example)	ENQ	H10	W(w)	SB	H06	%MW100	H02	H11112222	EOT	BCC
ASCII value	H05	H3130	H57(77)	H5342	H3036	H254D57313030	H3032	H3131313132323232	H04	

Note
<ul style="list-style-type: none"> • Number of data specifies the number according to the type of device. Namely, if the data type of device is WORD, and number of data is 5, it means that 5 WORDs should be written. • Number of data can be used up to 120Bytes (60 Words).

Item	Description
BCC	When command is lowercase(r), only one lower byte of the value resulted by adding 1 Byte each to ASCII values from ENQ to EOT is converted into ASCII and added to BCC.
Device Length (Name length of variable)	This indicates the number of name's characters that means device, which is allowable up to 16 characters. This value is one of ASCII converted from hex type, and the range is from H01 (ASCII value: 3031) to H10 (ASCII value: 3130).
Device	Address to be actually read. This must be ASCII value within 16 characters, and in this name, digits, upper/lower case, and '%' only are allowable to be entered.

● XGB Response format (ACK response)

Format name	Header	Station No.	Command	Command type	Tail	Frame check
Frame (Example)	ACK	H10	W(w)	SB	ETX	BCC
ASCII value	H06	H3130	H57(77)	H5342	H03	

Item	Description
BCC	When command is lowercase(r), only one lower byte of the value resulted by adding 1 Byte each to ASCII values from ACK to ETX is converted into ASCII and added to BCC, and sent.

- XGB Response format (NAK response)

Format name	Header	Station No.	Command	Command type	Error code (Hex 2 Byte)	Tail	Frame check
Frame (Example)	ENQ	H10	W(w)	SB	H1132	EOT	BCC
ASCII value	H05	H3130	H57(77)	H5342	H31313332	H03	

Item	Description
BCC	When command is lowercase(r), only one lower byte of the value resulted by adding 1 Byte each to ASCII values from NAK to ETX is converted into ASCII and added to BCC, and sent.
Error code	Hex and 2 bytes (ASCII code, 4 bytes) indicate error type. For the details, Refer to XGT dedicated communication error codes and countermeasures.

- Example

This example supposes that 2 byte H'AA15 is written in D000 of station No. 1.

- 1) PC request format (PC → XGB)

Format name	Header	Station No.	Command	Command type	Device Length	Device	Number of data	Data	Tail	Frame check
Frame (Example)	ENQ	H01	W(w)	SB	H06	%DW000	H01	HAA15	EOT	BCC
ASCII value	H05	H3031	H57(77)	H5342	H3036	H254457303030	H3031	H41413135	H04	

- 2) For ACK response after execution of command (PC ← XGB)

Format name	Header	Station No.	Command	Command type	Tail	Frame check
Frame (Example)	ACK	H01	W(w)	SB	ETX	BCC
ASCII value	H06	H3031	H57(77)	H5342	H03	

- 3) For NAK response after execution of command (PC ← XGB)

Format name	Header	Station No.	Command	Command type	Error code	Tail	Frame check
Frame (Example)	NAK	01	W(w)	SB	Error code (2)	ETX	BCC
ASCII value	H15	H3031	H57(77)	H5342	Error code (4)	H03	

2.6.2.4 Monitor variable register (X##)

Monitor register can separately register up to 16 (from 0 to 15) in combination with actual variable reading command, and carries out the registered one through monitor command after registration.

- PC request format

Format name	Header	Station No.	Command	Registration No.	Registration format	Tail	Frame check
Frame (Example)	ENQ	H10	X(x)	H09	Refer to registration format	EOT	BCC
ASCII value	H05	H3130	H58(78)	H3039	Refer to *1	H04	

Item	Description
BCC	When command is lowercase(x), only one lower byte of the value resulted by adding 1 byte each to ASCII values from ENQ to EOT is converted into ASCII, added to BCC.
Register No.	This can be registered up to 16 (0 to 15, H00-H0F), and if an already registered No. is registered again, the one currently being executed is registered.
Register Format	This is used to before EOT in command of Formats of separate reading of variable, continuous reading, and named variable reading.

*1 : Register Format of request Formats must select and use only one of the followings.

- 1) Individual reading of device

RSS	Number of blocks (2 Byte)	Device length (2 Byte)	Device name (16 Byte)	...
		1 block (max. 16 blocks)		

- 2) Continuous reading of device

RSB	Device length (2 Byte)	Device name (16 Byte)	Number of data
-----	------------------------	-----------------------	----------------

- XGB Response format (ACK response)

Format name	Header	Station No.	Command	Registration no.	Tail	Frame check
Frame (Example)	ACK	H10	X(x)	H09	ETX	BCC
ASCII value	H06	H3130	H58(78)	H3039	H03	

Item	Description
BCC	When command is lowercase(x), only one lower byte of the value resulted by adding 1 Byte each to ASCII values from ACK to ETX is converted into ASCII and added to BCC, and sent.

● XGB Response format (NAK response)

Format name	Header	Station No.	Command	Registration No.	Error code (Hex 2Byte)	Tail	Frame check
Frame(Example)	NAK	H10	X(x)	H09	H1132	ETX	BCC
ASCII value	H15	H3130	H58(78)	H3039	H31313332	H03	

Item	Description
BCC	When command is one of lower case(x), only one lower byte of the value resulted by adding 1 Byte each to ASCII values from NAK to ETX is converted into ASCII and added to BCC, and sent.
Error code	Hex and 2 bytes (ASCII code, 4 bytes) indicate error type. For the details, Refer to XGT dedicated communication error codes and countermeasures.

● Example

This example supposes that device M000 of station NO. 1 is monitor registered.

1) PC request format (PC → XGB)

Format name	Header	Station No.	Command	Registration No.	Registration Format				Tail	Frame check
					R##	Number of blocks	Device length	Device name		
Frame(Example)	ENQ	H01	X(x)	H01	RSS	H01	H06	%MW000	EOT	BCC
ASCII value	H05	H3031	H58(78)	H3031	H5253 53	H3031	H3036	H2554573030 30	H04	

2) For ACK response after execution of command (PC ← XGB)

Format name	Header	Station No.	Command	Registration No.	Tail	Frame check
Frame(Example)	ACK	H01	X(x)	H01	ETX	BCC
ASCII value	H06	H3031	H58(78)	H3031	H03	

3) For NAK response after execution of command (PC ← XGB)

Format name	Header	Station No.	Command	Registration No.	Error code	Tail	Frame check
Frame(Example)	NAK	H01	X(x)	H01	Error code (2)	ETX	BCC
ASCII value	H15	H3031	H58(78)	H3031	Error code (4)	H03	

2.6.2.5 Monitor execution (Y##)

This is a function that carries out the reading of the variable registered by monitor register. This also specifies a registered number and carries out reading of the variable registered by the number.

- PC request format

Format name	Header	Station No.	Command	Registration No.	Tail	Frame check
Frame (Example)	ENQ	H10	Y(y)	H09	EOT	BCC
ASCII value	H05	H3130	H59(79)	H3039	H03	

Item	Description
Register No.	Register No. uses the same number registered during monitor register for monitor execution. It is possible to set from 00-09 (H00-H09).
BCC	When command is lower case(y), only one lower byte of the value resulted by adding 1 byte each to ASCII values from ENQ to EOT is converted into ASCII, added to BCC.

- XGB Response format (ACK response)

1) In case that the register Format of register No. is the Individual reading of device

Format name	Header	Station No.	Command	Registration No.	Number of Blocks	Number of data	Data	Tail	Frame check
Frame (Example)	ACK	H10	Y(y)	H09	H01	H02	H9183	ETX	BCC
ASCII value	H06	H3130	H59(79)	H3039	H3031	H3032	H39313833	H03	

2) In case that the register Format of register No. is the continuous reading of device

Format name	Header	Station No.	Command	Registration No.	Number of data	Data	Tail	Frame check
Frame (Example)	ACK	H10	Y(y)	H09	H04	H9183AABB	ETX	BCC
ASCII value	H06	H3130	H59(79)	H3039	H3034	H3931383341414242 2	H03	

- XGB Response Format (NAK response)

Format name	Header	Station No.	Command	Registration No.	Error code (Hex 2Byte)	Tail	Frame check
Frame (Example)	NAK	H10	Y(y)	H09	H1132	ETX	BCC
ASCII value	H15	H3130	H59(79)	H3039	H31313332	H03	

Item	Description
BCC	When command is lowercase(y), only one lower byte of the value resulted by adding 1 Byte each to ASCII values from NAK to ETX is converted into ASCII and added to BCC, and sent.
Error code	Hex and 2 bytes (ASCII code, 4 bytes) indicate error type. For the details, Refer to XGT dedicated communication error codes and countermeasures.

- Example

This example supposes that registered device No. 1 of station No. 1 is read, and BCC value is checked. And it is supposed that device M000 is registered and the number of blocks is 1.

1) PC request format (PC → XGB)

Format name	Header	Station No.	Command	Registration No.	Tail	Frame check
Frame (Example)	ENQ	H01	Y(y)	H01	EOT	BCC
ASCII value	H05	H3031	H59(79)	H3031	H04	

2) For ACK response after execution of command (PC → XGB)

Format name	Header	Station No.	Command	Registration No.	Number of Blocks	Number of data	Data	Tail	Frame check
Frame (Example)	ACK	H01	Y(y)	H01	H01	H02	H2342	ETX	BCC
ASCII value	H06	H3031	H59(79)	H3031	H3031	H3032	H32333432	H03	

3) For NAK response after execution of command (PC → XGB)

Format name	Header	Station No.	Command	Registration No.	Error code	Tail	Frame check
Frame (Example)	NAK	H01	Y(y)	H01	Error code(2)	ETX	BCC
ASCII value	H15	H3031	H59(79)	H3031	Error code(4)	H03	

2.7 LS Bus Protocol

LS Bus Protocol communication is function executing communication between XGB Cnet and LS Inverter. User can configure LS Bus communication system between our products without special setting by using reading/writing data of internal device area and monitoring function

2.7.1 LS Bus Protocol

LS Bus Protocol communication is function executing communication between XGB Cnet and LS Inverter. User can configure LS Bus communication system between our products without special setting by using reading/writing data of internal device area and monitoring function.

The function of LS Bus Protocol supported by XGB is as follows.

- ◆ Device continuous reading
- ◆ Device continuous writing

2.7.1.1 Frame structure

2.7.1.1.1 Base format

(a) Request frame (External communication → XGB)

Header (ENQ)	Station number	Command	Structurized data area	Frame check (BCC)	Tail (EOT)
--------------	----------------	---------	------------------------	-------------------	------------

(b) ACK response frame (XGB → External communication, when receiving data normally)

Header (ACK)	Station number	Command	Structurized data area	Frame check (BCC)	Tail (EOT)
--------------	----------------	---------	------------------------	-------------------	------------

(c) NAK response frame (XGB → External communication, when receiving data abnormally)

Header (NAK)	Station number	Command	Error code (ASCII 4 Byte)	Frame check (BCC)	Tail (EOT)
--------------	----------------	---------	-----------------------------	-------------------	------------

Note

- 1) The numerical data of all frames are ASCII codes equal to hexadecimal value, if there's no clear statement. The terms in hexadecimal are as follows.
 - Station No.
 - Command type is supported R (read) and W (write).
 - All contents of data
- 2) If it is hexadecimal, H is attached in front of the number of frames like H01, H12345, H34, H12, and H89AB.
- 3) Available frame length is maximum 256 bytes.
- 4) Used control codes are as follows.

Code	Hex value	Name	Contents
ENQ	H05	Enquire	Request frame initial code
ACK	H06	Acknowledge	ACK response frame initial code
NAK	H15	Not Acknowledge	NAK response frame initial code
EOT	H04	End of Text	Request frame ending ASCII code

2.7.1.2 Command frame sequence

2.7.1.2.1 Sequence of command request frame

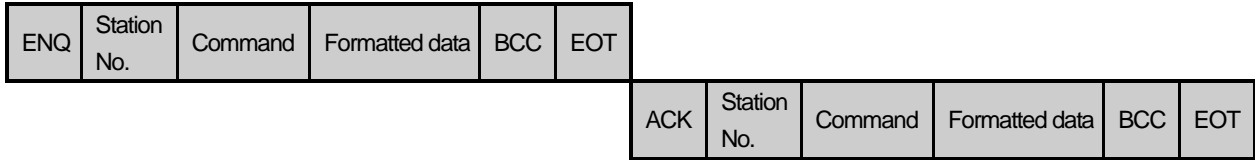

(Inverter ACK response)

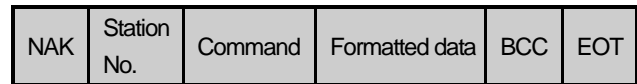

(Inverter NAK response)

2.7.1.2.2 List of commands

List of commands used in LS Bus communication is as shown below.

Classification Items	Command		Treatment
	Command type		
	Code	ASCII code	
Continuous read	R	H52	Read inverter variable of Word.
Continuous write	W	H57	Write inverter variable of Word.

2.7.2 Detail of instruction

2.7.2.1 Continuous writing to inverter (W)

This command is to write PLC data in specified address of inverter.

- LS Bus Client Request format

Format name	Header	Station No.	Command	Device Length	Address of inverter	Data	Frame check	Tail
Frame (Example)	ENQ	H20	W	H6	0100	H00E2	-	BCC	EOT
ASCII value	H05	H3230	H57	H36	H30313030	H30304532	-	-	H04

Item	Description
BCC	When ASCII value of each 1byte except ENQ and EOT is summed, the lowest 1byte of the result value is BCC.
Device Length	This specifies how many Words you will write. As converted value to ASCII, the range is from H01 (ASCII value: 3031) to H08 (ASCII value: 3038).
Address of inverter	Enter the address that you want to read. ASCII value above 4 characters and non-numeric is not allowed.
Data	When you write data H'A to inverter address 0100 area, the data format has to be H000A.

- Example)

If you want to write H1234, 31323334 (Converted value to ASCII) should be included in the data area. So, the highest value has to be sent first and the lowest value has to be sent last.

Note

- Device data of Word type is only supported.

● Inverter Response format(ACK response)

Format name	Header	Station No.	Command	Data		Frame check	Tail
Frame (Example)	ACK	H20	W	H00E2	...	BCC	EOT
ASCII value	H06	H3230	H57	H30304532	-	-	H04

Item	Description
BCC	When ASCII value of each 1byte except ENQ and EOT is summed, the lowest 1byte of the result value is BCC.

● Inverter Response format(NAK response)

Format name	Header	Station No.	Command	Error code (ASC 2 Byte)	Frame check	Tail
Frame (Example)	NAK	H20	W	H12	BCC	EOT
ASCII value	H15	H3230	H57	H3132	-	H04

Item	Description
BCC	When ASCII value of each 1byte except ENQ and EOT is summed, the lowest 1byte of the result value is BCC.
Error code	Error information is shown as hex 1byte (2bytes of ASCII code). For more information, please refer to the error code of the inverter user manual.

● Example

This describes if the user want to write "H00FF" to address number 1230 of station number 1 of inverter.

● XGB request format (XGB → Inverter)

Format name	Header	Station No.	Command	Device length	Address of inverter	Data	Frame check	Tail
Frame (Example)	ENQ	H01	W	H1	1230	H00FF	BCC	EOT
ASCII value	H05	H3031	H57	H3031	H31323330	H30304646	-	H04

● For ACK response after execution of command (XGB ← Inverter)

Format name	Header	Station No.	Command	Data	Frame check	Tail
Frame (Example)	ACK	H01	W	H00FF	BCC	EOT
ASCII value	H06	H3031	H57	H30304646	-	H04

● For NAK response after execution of command (XGB ← Inverter)

Format name	Header	Station No.	Command	Error code	Frame check	Tail
Frame (Example)	NAK	H01	W	H12	BCC	EOT
ASCII value	H15	H3031	H57	Error code (2 Byte)	-	H04

2.7.2.2 Continuous reading from inverter (R)

This is a function of continuous reading of designated amount of PLC data from designated address number.

- PC Request format

Format name	Header	Station No.	Command	Address of inverter	Number of data	Frame check	Tail
Frame (Example)	ENQ	H10	R	0100	H5	BCC	EOT
ASCII value	H05	H3130	H52	H30313030	H35	-	H04

Item	Description
BCC	When ASCII value of each 1byte except ENQ and EOT is summed, the lowest 1byte of the result value is BCC.
Device length	This specifies how many Words you will write. As converted value to ASCII, the range is from H01 (ASCII value: 3031) to H08 (ASCII value: 3038).
Address of inverter	Enter the address that you want to read. ASCII value above 4 characters and non-numeric is not allowed.

Note

- Device data of Word type is only supported.

● Inverter response format (ACK response)

Format name	Header	Station No.	Command	Data		Frame check	Tail
Frame (Example)	ACK	H20	R	H00E2	...	BCC	EOT
ASCII value	H06	H3230	H52	H30304532	-	-	H04

Item	Description
BCC	When ASCII value of each 1byte except ENQ and EOT is summed, the lowest 1byte of the result value is BCC.

● Inverter response format (NAK response)

Format name	Header	Station No.	Command	Error code (ASC 2 Byte)	Frame check	Tail
Frame (Example)	NAK	H20	R	H12	BCC	EOT
ASCII value	H15	H3230	H52	H3132	-	H04

Item	Description
BCC	When ASCII value of each 1byte except ENQ and EOT is summed, the lowest 1byte of the result value is BCC.
Error code	Error information is shown as hex 1byte (2bytes of ASCII code). For more information, please refer to the error code of the inverter user manual.

● Example

This describes if the user want to read 1Word data from address number 1230 of station number 1 of inverter..

● XGB request format (XGB → Inverter)

Format name	Header	Station No.	Command	Address of inverter	Device length	Frame check	Tail
Frame (Example)	ENQ	H01	R	1230	H1	BCC	EOT
ASCII value	H05	H3031	H52	H31323330	H31	-	H04

● For ACK response after execution of command (XGB ← Inverter)

Format name	Header	Station No.	Command	Data	Frame check	Tail
Frame (Example)	ACK	H01	R	H1234	BCC	EOT
ASCII value	H06	H3031	H52	H31323334	-	H04

● For NAK response after execution of command (XGB ← Inverter)

Format name	Header	Station No.	Command	Error code	Frame check	Tail
Frame (Example)	NAK	H01	R	H12	BCC	EOT
ASCII value	H15	H3031	H52	H3132	-	H04

2.8 Modbus Protocol

Modbus protocol is specified open protocol used between client-server, which executes reading/writing data according to function code. Communication between devices that use Modbus protocol uses Client-server function in which only one client processes the data.

2.8.1 Modbus Protocol

There are two communication modes of Modbus, ASCII and RTU.

Characteristic		ASCII mode	RTU mode
Coding method		ASCII code	8 bit binary code
No. of data per one character	Start bit	1	1
	Data bit	7	8
	Parity bit	Even,Odd,None	Even,Odd,None
	Stop bit	1 or 2	1 or 2
Error check		LRC(Longitudinal Redundancy Check)	CRC (Cyclical Redundancy Check)
Start of frame		Colon (:)	3.5 Character no response time

2.8.1.1 Structure of Modbus protocol

Modbus protocol's structure is as follows.

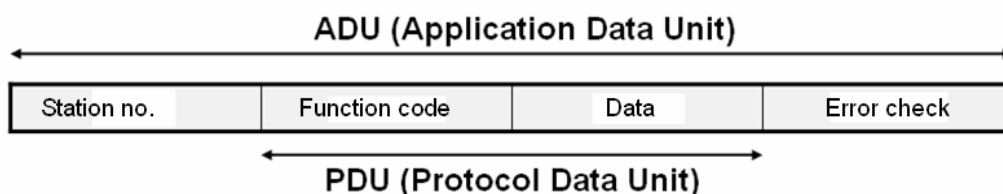

In case of normal communication, process step is as follows.

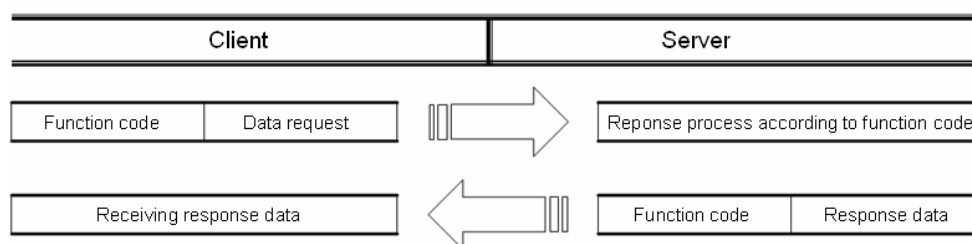

In case of abnormal communication, process step is as follows.

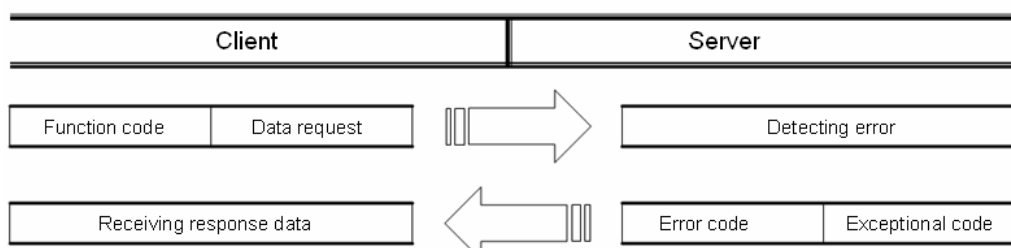

When receiving the abnormal frame from client, server transmits error code and exceptional code. Error code is function code adding 80(Hex) and exceptional code indicate the specific error content. Each code has following content.

Code	Code name	Meaning
01	Function code error	Function code error
02	Address error	Exceeds allowed address range
03	Data setting error	Not allowed data value
04	Server error	Server(slave) is error
05	Server requesting re-transmission	Now server is too busy to process and requests re-transmission later
06	Server process time delay	Server takes time to process. Master should request again.

2.8.2 Frame Structure

2.8.2.1 Frame structure in ASCII mode

Frame structure in the ASCII mode is as follows.

Classification	Start	Station no.	Function code	Data	Error check	End
Size (byte)	1	2	2	N	2	2

2.8.2.1.1 Characteristic of ASCII mode

- In the ASCII mode, start of frame is indicated with colon (:), which is ASCII code, and end of frame is indicated with 'CRLF'.
- Each character allows maximum 1s interval.
- How to check the error uses LRC, it takes 2's complement except frame of start and end and converts it as ASCII conversion.

2.8.2.1.2 Address area

- It consists of 2 byte.
- When using the XGT Cnet I/F module, range of station is 0~31.
- Station number 0 is used for client.
- When server responds, it contains self address to response frame to know client's response.

2.8.2.1.3 Data area

- Transmits the data by using the ASCII data, data structure changes according to function code.
- In case of receiving normal frame, it responds as normal response.
- In case of receiving abnormal frame, it responds by using error code.

2.8.2.1.4 Error check area

How to check error of frame takes 2's complement except start and end of frame and converts it as ASCII.

2.8.2.2 Frame structure in RTU mode

Frame structure in the RTU mode is as follows.

Classification	Start	Station number	Function code	Data	Error check	End
size(byte)	Idle time	1	1	N	2	Idle time

2.8.2.2.1 Characteristic of RTU mode

- a) It uses hexadecimal.
- b) Start character is station number and frame is classified by CRC error check.
- c) Start and end of frame is classified by adding idle time of 1 bit.
- d) Between frames, there is interval of 3.5 character time. When exceeding 1.5 character time, it is acknowledged as independent frame.

2.8.2.2.2 Address area

- a) It consists of 1 byte.
- b) When using the XGT Cnet I/F module, range of station is 0~31.
- c) Station number 0 is used for client.
- d) When server responds, it contains self address to response frame to know client's response.

2.8.2.2.3 Data area

- a) Transmits the data by using the Hex. data, data structure changes according to function code.
- b) In case of receiving normal frame, it responds as normal response.
- c) In case of receiving abnormal frame, it responds by using error code.

2.8.2.2.4 Error check area

It determines if frame is normal or not by using CRC check of 2 byte.

2.8.2.2.5 Modbus address regulation

Address in the data starts from 0 and it is same with value that is minus 1 from modbus memory, Modbus address is same with address 1 of data.

2.8.2.3 Expression of data and address

To express data and address of modbus protocol, the characteristic is as follows.

- 1) It used hexadecimal as basic form.
- 2) In the ASCII mode, Hex data is converted into ASCII code.
- 3) RTU mode uses Hex data.
- 4) Each function code has following meaning.

Code(Hex)	Purpose	Used area	address	Max. response data
01	Read Coil Status	Bit output	0XXXX	2000bit
02	Read Input Status	Bit input	1XXXX	2000bit
03	Read Holding Registers	Word output	4XXXX	125word
04	Read Input Registers	Word input	3XXXX	125word
05	Force Single Coil	Bit output	0XXXX	1bit
06	Preset Single Register	Word output	4XXXX	1 word
0F	Force Multiple Coils	Bit output	0XXXX	1968bit
10	Preset Multiple Registers	Word output	4XXXX	120word

Modbus Instruction

2.8.2.4 Reading data of bit type at the bit output (01)

2.8.2.4.1 Reading bit of output area (function code: 01)

In case of reading data of bit type, request and response frame is as follows.

Detail of frame is applied in case of ASCII mode.

(a) Request frame

Frame	Station no.	Function code (01)	Address	Data size	Frame error check	Tail (CRLF)
Size (byte)	1	1	2	2	2	2

(b) Response frame (In case of receiving normal frame)

Frame	Station no.	Function code (01)	No. of byte	Data	Frame error check	Tail (CRLF)
Size (byte)	1	1	2	N	2	2

(c) In case of response frame (In case of receiving abnormal frame)

Frame	Station no.	Error code	Exceptional code	Tail (CRLF)
Size (byte)	1	1	1	2

2.8.2.4.2 Details of frame

- (a) Station no.: indicates the station no. of slave to read bit of output area.
- (b) Function code: '01' indicating Read Coil Status
- (c) Address: start address of data to read and it consists of 2 byte. At this time, start address conforms to modbus address regulation.
- (d) Data size: size of data to read and it consists of 2 byte.
- (e) Frame error check: in case of ASCII mode, it uses LRC and in case of STU mode, it uses CRC. It consists of 2 byte.
- (f) Tail: it is applies in case of ASCII mode, CRLF is added after LRC.
- (g) No. of byte: no. of byte of response data
- (h) Data: makes address of request frame as start address and transmits data with byte unit
- (i) Error code: error code is expressed by adding 80(Hex) to function code and in case of reading bit of output area, it is expressed as 81(Hex).
- (j) Exceptional code: indicates detail of error and consists of 1 byte

2.8.2.4.3 Frame example

Example that requests reading bit of 20~28 to station number 1 server acting as modbus RTU mode

(a) Request frame

Classification	Station no.	Function code	Address		Data size		Error check
			Upper byte	Lower byte	Upper byte	Lower byte	
Frame	01	01	00	13	00	13	CRC

(b) Response frame (In case receiving normal frame)

Classification	Station no.	Function code	No. of byte	Data			Error check
Frame	01	01	03	12	31	05	CRC

(c) Response frame (In case of receiving abnormal frame)

Classification	Station no.	Function code	Exceptional code	Error check
Frame	01	81	02	CRC

2.8.2.5 Reading data of bit type at the bit input (02)

2.8.2.5.1 Reading bit of input area

In case of reading data of bit type of input area, request and response frame is as follows.

Tail of frame is applied in case of ASCII mode.

(a) Request frame

Classification	Station no.	Function code (02)	Address	Data size	Frame error check	Tail (CRLF)
Size (byte)	1	1	2	2	2	2

(b) Response frame (In case of receiving normal frame)

Classification	Station no.	Function code (02)	No. of byte	Data	Frame error check	Tail (CRLF)
Size (byte)	1	1	2	N	2	2

(c) Response frame (In case of receiving abnormal frame)

Classification	Station no.	Error code	Exceptional code	Tail (CRLF)
Size (byte)	1	1	1	2

2.8.2.5.2 Details of frame

- (a) Station no.: indicates station no. of slave to read bit of input area
- (b) Function code: '02' indicating Read Input Status
- (c) Address: indicating start address of data to read. It consists of 2 byte. At this time, start address conforms to modbus address regulation.
- (d) Data size: size of data to read, consists of 2 byte
- (e) Frame error check: in case of ASCII mode, it uses LRC and in case of STU mode, it uses CRC for error check. It consists of 2 byte.
- (f) Tail: it is applied in case of ASCII mode, CRLF is added after LRC.
- (g) No. of byte: no. of byte of data responding
- (h) Data: address of request frame is start address and transmits data with byte unit.

- (i) Error code: Error code is expressed by adding 80(Hex) and in case of reading bit of output area, it is expressed 82(Hex).
- (j) Exceptional code: details of error, consists of 1 byte.

2.8.2.5.3 Frame example

Example that reads bit (20~38) from station number 1 server acting as modbus RTU

(a) Request frame

Classification	Station no.	Function code	Address		Data size		Error check
			Upper byte	Lower byte	Upper byte	Lower byte	
Frame	01	02	00	13	00	13	CRC

(b) Response frame (When receiving normal frame)

Classification	Station no.	Function code	No. of byte	Data			Error check
Frame	01	02	03	12	31	05	CRC

(c) Response frame (When receiving abnormal frame)

Classification	Station no.	Function code	Exceptional code	Error check
Frame	1	82	2	CRC

2.8.2.6 Reading data of word type at the word output (03)

2.8.2.6.1 Reading word of output area

When reading data of word type of output area, request and response frame is as follows.

Tail of frame is applied in case of ASCII mode.

(a) Request frame

Classification	Station no.	Function code (03)	Address	Data size	Frame error check	Tail (CRLF)
Size (byte)	1	1	2	2	2	2

(b) Response frame (When receiving normal frame)

Classification	Station no.	Function code (03)	No. of byte	Data	Frame error check	Tail (CRLF)
Size (Byte)	1	1	2	N*2	2	2

(c) Response frame (When receiving abnormal frame)

Classification	Station no.	Error code	Exceptional code	Tail (CRLF)
Size (byte)	1	1	1	2

2.8.2.6.2 Details of frame

- (a) Station no.: indicates the station no. of slave to read word data of output area.
- (b) Function code: '03' indicating Read Holding Registers
- (c) Address: indicating start address of data to read. It consists of 2 byte. At this time, start address conforms to modbus address regulation.
- (d) Data size: size of data to read, consists of 2 byte
- (e) Frame error check: in case of ASCII mode, it uses LRC and in case of STU mode, it uses CRC for error check. It consists of 2 byte.

- (f) Tail: it is applied in case of ASCII mode, CRLF is added after LRC.
- (g) No. of byte: no. of byte of data responding
- (h) Data: address of request frame is start address and transmits data with byte unit. At this time, since data is word type, it is double of no. of byte.
- (i) Error code: error code is expressed by adding 80(Hex) and in case of reading word of output area, it is expressed 83(Hex).
- (j) Exceptional code: details of error, consists of 1 byte.

2.8.2.6.3 Frame example

Example that reads word (108~110) from station number 1 server acting as modbus RTU

(a) Request frame

Classification	Station no.	Function code	Address		Data size		Error check
			Upper byte	Lower byte	Upper byte	Lower byte	
Frame	01	03	00	6B	00	03	CRC

(b) Response frame (receiving normal frame)

Classification	Station no.	Function code	No. of byte	Data						Error check
Frame	01	03	06	13	12	3D	12	40	4F	CRC

(c) Response frame (receiving abnormal frame)

Classification	Station no.	Function code	Exceptional code	Error check
Frame	01	83	04	CRC

2.8.2.7 Reading data of word type at the word input (04)

2.8.2.7.1 Reading word of input area

In case of reading word of input area, request and response frame is as follows.

Tail of frame is applied in case of ASCII mode.

(a) Request frame

Classification	Station no.	Function code (04)	Address	Data size	Frame error check	Tail (CRLF)
Size (byte)	1	1	2	2	2	2

(b) Response frame (In case of receiving normal frame)

Classification	Station no.	Function code (04)	No. of byte	Data	Frame error check	Tail (CRLF)
Size (byte)	1	1	2	N*2	2	2

(c) In case of response frame (In case of receiving abnormal frame)

Classification	Station no.	Error code	Exceptional code	Tail (CRLF)
Size (byte)	1	1	1	2

2.8.2.7.2 Details of frame

- (a) Station no.: indicates the station no. of slave to read word of input area.
- (b) Function code: '04' indicating Read Input Registers
- (c) Address: start address of data to read and it consists of 2 byte. At this time, start address conforms to modbus address regulation.

- (d) Data size: size of data to read and it consists of 2 byte.
- (e) Frame error check: in case of ASCII mode, it uses LRC and in case of STU mode, it uses CRC. It consists of 2 byte.
- (f) Tail: it is applies in case of ASCII mode, CRLF is added after LRC.
- (g) No. of byte: no. of byte of response data
- (h) Data: makes address of request frame as start address and transmits data with byte unit. At this time, since data is word type, it is double of no. of byte.
- (i) Error code: error code is expressed by adding 80(Hex) to function code and in case of reading word of input area, it is expressed as 84(Hex).
- (j) Exceptional code: indicates detail of error and consists of 1 byte

2.8.2.7.3 Frame example

Example that requests reading word of 9 to station number 1 server acting as modbus RTU mode

(a) Request frame

Classification	Station no.	Function code	Address		Data size		Error check
			Upper byte	Lower byte	Upper byte	Lower byte	
Frame	01	04	00	08	00	01	CRC

(b) Response frame (In case receiving normal frame)

Classification	Station no.	Function code	No. of byte	Data		Error check
Frame	01	04	02	00	0A	CRC

(c) Response frame (In case of receiving abnormal frame)

Classification	Station no.	Function code	Exceptional code	Error check
Frame	01	84	04	CRC

2.8.2.8 Individual writing data of bit type at the bit output (05)

2.8.2.8.1 Individual writing bit of output area

When writing single bit of output area, request and response frame is as follows.

Tail of frame is applied in case of ASCII mode.

(a) Request frame

Classification	Station no.	Function code (05)	Address	Output	Frame error check	Tail (CRLF)
Size (byte)	1	1	2	2	2	2

(b) Response frame (In case of receiving normal frame)

Classification	Station no.	Function code (05)	Address	Output	Frame error check	Tail (CRLF)
Size (byte)	1	1	2	2	2	2

(c) In case of response frame (In case of receiving abnormal frame)

Classification	Station no.	Error code	Exceptional code	Tail (CRLF)
Size (byte)	1	1	1	2

2.8.2.8.2 Details of frame

- (a) Station no.: indicates the station no. of slave to write single bit of output area.
- (b) Function code: '05' indicating Force Single Coil
- (c) Address: start address of data to write and it consists of 2 byte. At this time, start address conforms to modbus address regulation.
- (d) Output: in case of turning on address set in the Address, FF00(Hex) is indicated and in case of turning off address set in the Address, it is indicated 0000(Hex).
- (e) Frame error check: in case of ASCII mode, it uses LRC and in case of STU mode, it uses CRC. It consists of 2 byte.
- (f) Tail: it is applies in case of ASCII mode, CRLF is added after LRC.
- (g) No. of byte: no. of byte of response data
- (h) Error code: error code is expressed by adding 80(Hex) to function code and in case of Force Single Coil, it is expressed as 85(Hex).
- (i) Exceptional code: indicates detail of error and consists of 1 byte

2.8.2.8.3 Frame example

Example that turning on 9th bit to station number 1 server acting as Modbus RTU mode

(a) Request frame

Classification	Station no.	Function code	Address		Output		Error check
			Upper byte	Lower byte	Upper byte	Lower byte	
Frame	01	05	00	08	FF	00	CRC

(b) Response frame (In case receiving normal frame)

Classification	Station no.	Function code	Address		Output		Error check
			Upper byte	Lower byte	Upper byte	Lower byte	
Frame	01	05	00	08	FF	00	CRC

(c) Response frame (In case of receiving abnormal frame)

Classification	Station no.	Function code	Exceptional code	Error check
Frame	01	85	04	CRC

2.8.2.9 Individual writing data of word type at the word output (06)

2.8.2.9.1 Individual writing word of output area

In case of writing single word to output area, request and response frame is as follows.
Detail of frame is applied in case of ASCII mode.

a) Request frame

Classification	Station no.	Function code (06)	Address	Output	Frame error check	Tail (CRLF)
Size (byte)	1	1	2	2	2	2

b) Response frame (In case of receiving normal frame)

Classification	Station no.	Function code (06)	Address	Output	Frame error check	Tail (CRLF)
Size (byte)	1	1	2	2	2	2

c) In case of response frame (In case of receiving abnormal frame)

Classification	Station no.	Error code	Exceptional code	Tail (CRLF)
Size (byte)	1	1	1	2

2.8.2.9.2 Details of frame

- (a) Station no.: indicates the station no. of slave to write single word of output area.
- (b) Function code: '06' indicating Preset Single Register
- (c) Address: start address of data to write and it consists of 2 byte. At this time, start address conforms to modbus address regulation.
- (d) Output: data value to write in the address set in the Address.
- (e) Frame error check: in case of ASCII mode, it uses LRC and in case of STU mode, it uses CRC. It consists of 2 byte.
- (f) Tail: it is applies in case of ASCII mode, CRLF is added after LRC.
- (g) No. of byte: no. of byte of response data
- (h) Error code: error code is expressed by adding 80(Hex) to function code and in case of writing single word of output area, it is expressed as 86(Hex).
- (i) Exceptional code: indicates detail of error and consists of 1 byte

2.8.2.9.3 Frame example

Example writing 0003(Hex) to 9th word of station number 1 server acting as modbus RTU mode

(a) Request frame

Classification	Station no.	Function code	Address		Output		Error check
			Upper byte	Lower byte	Upper byte	Lower byte	
Frame	01	06	00	08	00	03	CRC

(b) Response frame (In case receiving normal frame)

Classification	Station no.	Function code	Address		Output		Error check
			Upper byte	Lower byte	Upper byte	Lower byte	
Frame	01	06	00	08	00	03	CRC

(c) Response frame (In case of receiving abnormal frame)

Classification	Station no.	Function code	Exceptional code	Error check
Frame	01	86	02	CRC

2.8.2.10 Continuous writing data of bit type at the bit output (0F)

2.8.2.10.1 Continuous writing bit of output area

In case of writing continuous bit to output area, request and response frame is as follows.
Tail of frame is applied in case of ASCII mode.

(a) Request frame

Classification	Station no.	Function code (0F)	Address	No. of output	Data size	Output	Frame error check	Tail (CRLF)
Size (byte)	1	1	2	2	1	N	2	2

(b) Response frame (In case of receiving normal frame)

Classification	Station no.	Function code (0F)	Address	No. of output	Frame error check	Tail (CRLF)
Size (byte)	1	1	2	2	2	2

(c) In case of response frame (In case of receiving abnormal frame)

Classification	Station no.	Error code	Exceptional code	Tail (CRLF)
Size (byte)	1	1	1	2

2.8.2.10.2 Details of frame

- (a) Station no.: indicates the station no. of slave to write continuous bit of output area.
- (b) Function code: '06' indicating Force Multiple Coils
- (c) Address: start address of data to read and it consists of 2 byte. At this time, start address conforms to Modbus address regulation.
- (d) No. of output: no. of output to write and it consists of 2 byte
Ex.) When writing 10 continuous data from address number 20, no. of output is 000A(Hex)
- (e) Data size: indicates no. of output as byte. Namely, in case data size is 1, no. of data is 9.
Ex.) In case of writing 10 continuous bits, data size is 2.
- (f) Output: data value to write in the address set in the Address.
- (g) Frame error check: in case of ASCII mode, it uses LRC and in case of STU mode, it uses CRC. It consists of 2 byte.
- (h) Tail: it is applies in case of ASCII mode, CRLF is added after LRC.
- (i) No. of byte: no. of byte of response data
- (j) Error code: error code is expressed by adding 80(Hex) to function code and in case of writing continuous bit of output area, it is expressed as 8F(Hex).
- (k) Exceptional code: indicates detail of error and consists of 1 byte.

2.8.2.10.3 Frame example

Example writing 10 continuous bits starting 20th address of 1 server acting as Modbus RTU mode

Ex.) Data value to write continuously

Bit value	1	1	0	0	1	1	0	1	0	0	0	0	0	0	0	1
Hex	C				D				0				1			
Address	27	26	25	24	23	22	21	20	-	-	-	-	-	-	29	28

(a) Request frame

Classification	Station no.	Function code	Address		No. of output		Data size	Output		Error check
			Upper byte	Lower byte	Upper byte	Lower byte		Upper byte	Lower byte	
Frame	01	0F	00	13	00	0A	02	CD	01	CRC

(b) Response frame (In case receiving normal frame)

Classification	Station no.	Function code	Address		No. of output		Error check
			Upper byte	Lower byte	Upper byte	Lower byte	
Frame	01	04	00	13	00	0A	CRC

(c) Response frame (In case of receiving abnormal frame)

Classification	Station no.	Function code	Exceptional code	Error check
Frame	01	8F	01	CRC

2.8.2.11 Continuous writing data of word type at the word output (10)

2.8.2.11.1 Continuous writing word of output area

In case of writing word continuously to output area, request and response frame is as follows.
Tail of frame is applied in case of ASCII mode.

(a) Request frame

Classification	Station no.	Function code (10)	Address	No. of output	Data size	Output	Frame error check	Tail (CRLF)
Size (byte)	1	1	2	2	1	N*2	2	2

(b) Response frame (In case of receiving normal frame)

Classification	Station no.	Function code (10)	Address	No. of output	Frame error check	Tail (CRLF)
Size (byte)	1	1	2	2	2	2

(c) In case of response frame (In case of receiving abnormal frame)

Classification	Station no.	Error code	Exceptional code	Tail (CRLF)
Size (byte)	1	1	1	2

2.8.2.11.2 Details of frame

- (a) Station no.: indicates the station no. of slave to write continuous word of output area.
- (b) Function code: '10' indicating Preset Multiple Registers
- (c) Address: start address of data to read and it consists of 2 byte. At this time, start address conforms to modbus address regulation.
- (d) No. of output: no. of output to write and it consists of 2 byte
Ex.) When writing 10 continuous data from address number 20, no. of output is 000A(Hex)
- (e) Data size: indicates no. of output as byte. Since data type is word, in case of writing data of 1 word, data size is 2.
- (f) Output: data value to write in the address set in the Address.
- (g) Frame error check: in case of ASCII mode, it uses LRC and in case of STU mode, it uses CRC. It consists of 2 byte.
- (h) Tail: it is applied in case of ASCII mode, CRLF is added after LRC.
- (i) No. of byte: no. of byte of response data
- (j) Error code: error code is expressed by adding 80(Hex) to function code and in case of writing continuous word of output area, it is expressed as 90(Hex).
- (k) Exceptional code: indicates detail of error and consists of 1 byte.

2.8.2.11.3 Frame example

Example writing continuous 2 words starting 20th address of server 1 acting as Modbus RTU mode

Ex.) value to write continuously

Hex	C	D	0	1	0	0	0	0	A
Address	20				21				

(a) Request frame

Classification	Station no.	Function code	Address		No. of output		Data size	Output				Error check
			Upper byte	Lower byte	Upper byte	Lower byte						
Frame	01	10	00	13	00	02	04	CD	01	00	0A	CRC

(b) Response frame (In case receiving normal frame)

Classification	Station no.	Function code	Address		No. of output		Error check
			Upper byte	Lower byte	Upper byte	Lower byte	
Frame	01	10	00	13	00	02	CRC

(c) Response frame (In case of receiving abnormal frame)

Classification	Station no.	Function code	Exceptional code	Error check
Frame	01	90	01	CRC

2.9 Diagnosis Function

With XG5000 used, the status of the system and the network can be checked and diagnosed. Diagnosis function is composed as described below

- ▶ CPU module information
- ▶ Communication module information
- ▶ Frame monitor
- ▶ Status by service

2.9.1 Diagnosis Function of XG5000

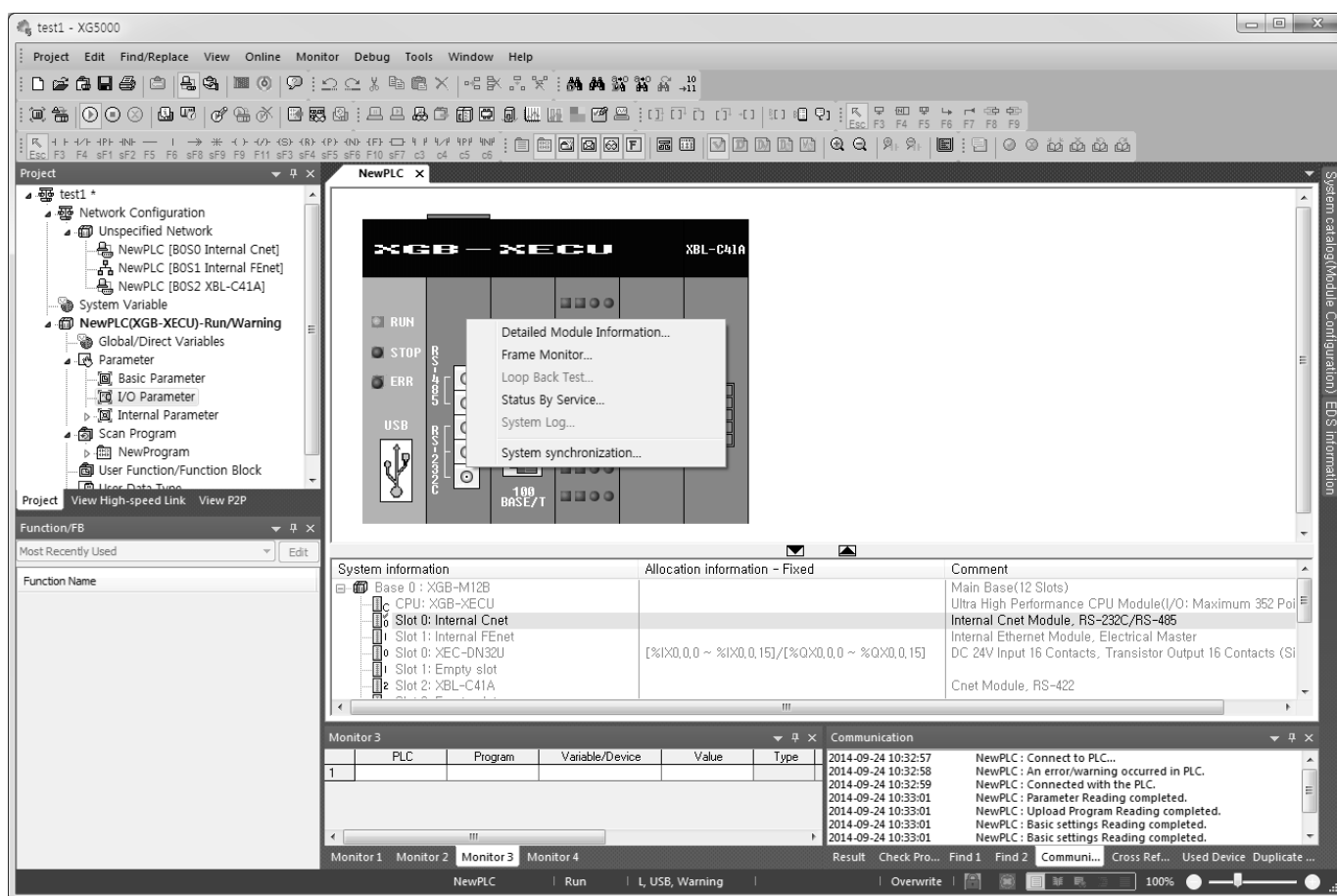

How to diagnosis system and network status by XG5000 system diagnosis are described below.

Connect XG5000 to loader port of main unit and if you select “Online -> Communication module setting -> System Diagnosis”, the following window is created.





- Select [Online] – [Communication module setting] – [System Diagnosis] and click the icon ().
- Click the right button on the the relevant module and click Frame Monitor or Status By Service to check.

2.9.1.1 Checking status of main unit

Check list	Detail result
CPU Module information	
<p>1. Select [Online] – [Communication module setting] – [System Diagnosis] or click the icon ().</p> <p>2. You can check the status of main unit by clicking CPU module information after clicking main unit.</p>	

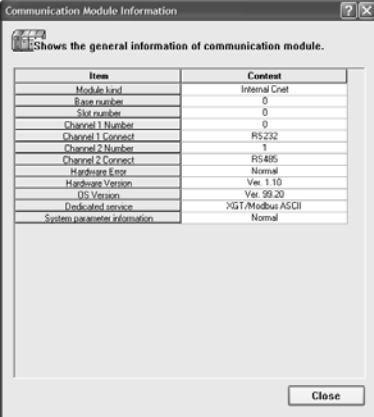
2.9.1.2 Communication module information

Check list	Detail result
Communication module information	
<p>1. Select [Online] – [Communication module setting] – [System Diagnosis] or click the icon ().</p> <p>2. You can check communication module status by clicking communication module information and click the right button after clicking Cnet I/F module and built-in communication.</p> <p>3. Meaning of each item of communication module information is as follows.</p>	

Item	Content	Remark
Module kind	Information of module kind under diagnosis	
Base number	Base information of communication module under diagnosis. It is fixed as 0 at XGB PLC.	
Slot number	Slot no. of communication module under diagnosis In case of built-in communication, it is fixed as 0.	
Station number	Station no. of relevant channel used at dedicated service, P2P	
Connection method	Information of communication type (RS-232C, RS-422) of relevant channel	
Hardware error	Indicates whether hardware of communication module is normal or not.	
Hardware version	Version of communication module hardware	
OS version	Indicates version of communication module OS	
P2P	Indicates whether P2P communication is activated or not	
System parameter information	Whether standard communication parameter is downloaded or not Standard communication parameter error information expression	

2.9.1.3 Frame monitor

The user can check whether frame is normal or not by monitoring TRX frame through Cnet I/F module by XG-PD's frame monitor.

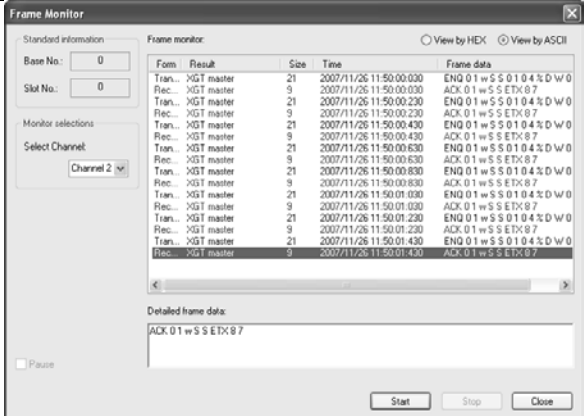
Check list	Detail result
Frame monitor	

1. Select [Online] – [Communication module setting] – [System Diagnosis] or click the icon ().
2. If you click right button after clicking Cnet I/F module and click frame monitor, you can monitor current communication data.
3. If you use frame monitor function, you can check frame of TRX data between Cnet I/F module and external communication device easily.
4. Detailed content of information indicated frame monitor window is as follows.

Item		Content	Remark
Standard information	Base No.	Information of base number under diagnosis	
	Slot No.	Information of slot number under diagnosis	
Monitor selections	Select Channel	Select channel to monitor	
Frame monitor window	Form	Indicates whether it is TX or RX frame.	
	Result	Indicates the protocol type 1) XGT server 2) XGT client 3) Modbus server 4) Modbus client 5) User definition frame 6) Unknown: frame that Cnet can't deal with	
	Size	Size of frame	
	Time	Time when sending/receiving the frame In case main unit is standard type (XBM-D***S), it indicates elapsed time from start.	
	Frame data	Indicates the frame data	
View by HEX		Indicates the frame data as HEX	
View by ASCII		Indicates the frame data as ASCII	
Start		Starts the frame monitor	
Stop		Stops the frame monitor	
Close		Closes the frame monitor window	



2.9.1.4 Status by service(Dedicated Service)

Check list	Detail result
Dedicated service	

1. Select [Online] – [Communication module setting] – [System Diagnosis] or click the icon ().
2. Click the right button on the the Cnet I/F module and click Status By Service.
3. Click Dedicated Service tap.
4. Check the status by service by clicking Multiple Reading and Refresh
5. Detailed content of information indicated in dedicated service window is as follows.

Classification	Item	Content	
Multiple reading/Refresh	Multiple reading	Checks the dedicated service status every second.	
	Refresh	Checks the dedicated service status information at started time	
Dedicated Service	Standard information	Base Number	Information of base number under diagnosis
		Slot Number	Information of slot number under diagnosis
		Link type	Type of communication module under diagnosis
	Dedicated service information		Drive type by service
	Detailed information window	Port number	Channel number
		Service count	Indicates how many dedicated service communication is done
		Error count	Indicates how many error occurs during dedicated service communication
Status		Indicates status of dedicated service communication	

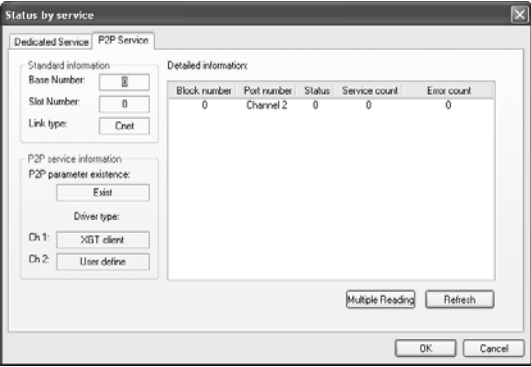
2.9.1.5 Status by service(P2P Service)

Check list	Detail result
P2P service	
<ol style="list-style-type: none"> 1. Select [Online] – [Communication module setting] - [System diagnosis] or click the icon (). 2. Click the right button on the the Cnet I/F module and click Status By Service. 3. Click P2P service of Status by Service 4. Click mutple reading and check Status by Service. 	

Classification	Item		Contents
P2P service	Standard information	Base number	Information of base number under diagnosis
		Slot number	Information of slot number under diagnosis
		Link type	Type of communication module under diagnosis
	P2P service information	P2P parameter existence	Indicates whether P2P parameter exists or not
		Driver type	Indicates the P2P driver by port XGT/Modbus/User definition frame
	Detailed information	Block number	Available range:0~63 Only block under operation is indicated.
		Port number	Indicates the channel number
		Status	Indicates the status by service
		Service count	Indicates how many P2P service is done.
Error count		Indicates how many error occurs during service	
Multiple reading/Refresh	Multiple reading		Checks the P2P service status every second.
	Refresh		Check the P2P service status when refresh is done.

2.9.1.6 Service status code

It is used to check whether Cnet I/F module is normal or not.

Dedicated service		P2P service	
Status	Meaning	Status	Meaning
0	Normal	0	Normal
1	Error of RX frame head (There is no ACK/NAK.)	4	Error of max. station number (Available range: 0~255)
2	Error of RX frame tail (There is no tail.)	5	Time out
3	BCC error of RX frame	FFFE	1. Modbus address error 2. Commands except Read/Write are used.
9	Station number of RX frame is different with self station number (Self station number = 0)		
0A	In case of not get response from CPU		
0B	RX frame size exceeds the modbus max. frame size		
0C	RX frame is not Modbus ASCII/RTU.		
0D	HEX conversion error in Modbus		

2.9.2 Trouble Shooting by Error

2.9.2.1 Trouble shooting when P2P parameter setting error occurs in case of XG5000 connection

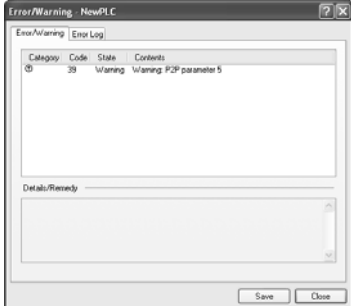
Phenomenon	Reason	Trouble shooting
<p>P2P setting error warning in case of XG5000 connection</p> 	<p>In case of enabling link, the user enabled the link where P2P is not set</p>	<ol style="list-style-type: none"> 1. In Enable Link menu of XG5000, check P2P setting number and delete P2P number not selected properly. 2. After disconnecting XG-PD, connect XG5000 again and check

2.9.2.2 Trouble shooting when communication is not done after P2P client setting

Phenomenon	Reason	Trouble shooting
<p>Tough communication setting is completed, Tx/Rx LED of Cnet I/F doesn't flicker</p>	<p>In case CPU is stop mode</p>	<p>Connect XG5000 and check CPU mode. If CPU mode is stop, change mode into RUN.</p>
	<p>Non-coincidence of communication standard parameter between client and server</p>	<p>Connect XG-PD and click [File] – [Open from PLC]. Check standard settings of module acting as client and server.</p>
	<p>Enable Link setting error</p>	<p>After executing P2P parameter, enable right P2P link</p>

2.9.2.3 Trouble shooting when response frame is missed in case of acting as client and using RS-485

Phenomenon	Reason	Trouble shooting
<p>After setting diverse P2P parameter in P2P block, if frame monitor is executed, response frame is missed.</p>	<p>In case P2P conditional flag is faster than communication time</p>	<ol style="list-style-type: none"> 1. Consider communication time and change P2P conditional flag. 2. Communication time: transmission time + reception time - transmission time: conditional flag+CPU Scan Time+reaction time of communication module+data transmission time - reception time: CPU Scan Time + reaction time of communication module+data transmission time
	<p>In case that response time of partner is slow.</p>	<ol style="list-style-type: none"> 1. Increase Delay time in standard settings of XG-PD.

2.9.2.4 Two response frame are dealt with as unknown when executing frame monitor

Phenomenon					Reason	Trouble shooting
Two response frame are dealt with as unknown when executing frame monitor					Communication type in XG-PD is set as RS-422 but output wiring method is RS-485	Change communication type as RS-485 and write it to PLC.
Transmission	XGT master	17	2007/12/4 ...	ENQ 01rS S 0104 %M W 0EOT 4 0		
Reception	Unknown	17	2007/12/4 ...	ENQ 01rS S 0104 %M W 0EOT 4 0		
Reception	Unknown	17	2007/12/4 ...	ACK 01rS S 0102 0000 ETX 05		
Transmission	XGT master	17	2007/12/4 ...	ENQ 01rS S 0104 %M W 0EOT 4 0		

2.9.2.5 Unable to analyze TRX frame

Phenomenon	Reason	Trouble shooting
Unable to analyze TRX frame	More than one server sends frame	1. Execute 1:1 communication with server and check if it works properly. 2. Take interlock for servers not to sends frame simultaneously.
	In case parity bit setting is not coincident	Set the parity bit to be same each other
	In case stop bit setting is not coincident	Set the stop bit to be same each other
	In case communication speed setting is not coincident	Set the communication speed to be same each other
	In case of multi drop, terminal resistance is not installed	Install terminal resistance

2.9.2.6 Unable to know which one is reason of error, client or server

Phenomenon	Reason	Trouble shooting
Unable to know which one is reason of error, client or server	-	1. Check Cnet I/F module - Check module's equipment status - Check wiring 2. Check main unit status

2.9.2.7 Communication is not normal or communication is not executed repeatedly

Phenomenon	Reason	Trouble shooting
Communication is not normal or communication is not executed repeatedly	In case of multi drop, More than one server sends frame	1. Execute 1:1 communication with server and check if it works properly. 2. Take interlock for servers to sends frame simultaneously.
	Connection error of wiring communication line	Change cable or check connection of cable
	In case of RS-485 (Half duplex), non-coincidence of timing of TRX signal	Increase delay time of client and server
	1. When transmission is not complete, it requests next process of transmission 2. When reception is not complete, it requests next process of reception	Use handshake in program thoroughly



2.10 Example Program





2.10.1 Setting of Cnet I/F Module in the XG5000

Operation of XGT Cnet I/F is divided into P2P service and Server.

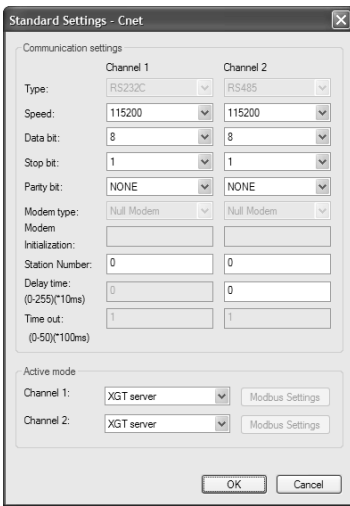
- P2P service: acts as client (master) and request reading/writing.
 - XGT client
 - Modbus RTU/ASCII client
 - User frame definition
- Server: acts as server (slave) and acts according to request
 - XGT server
 - Modbus RTU server
 - Modbus ASCII server



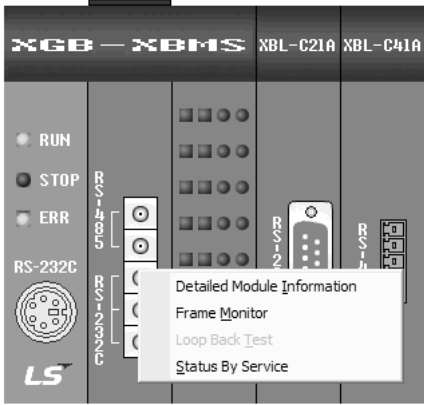

2.10.1.1 In case of acting as server

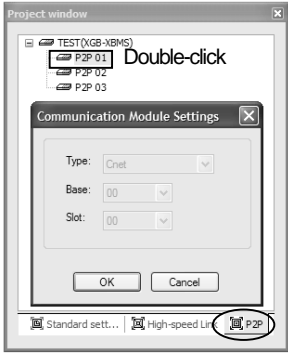
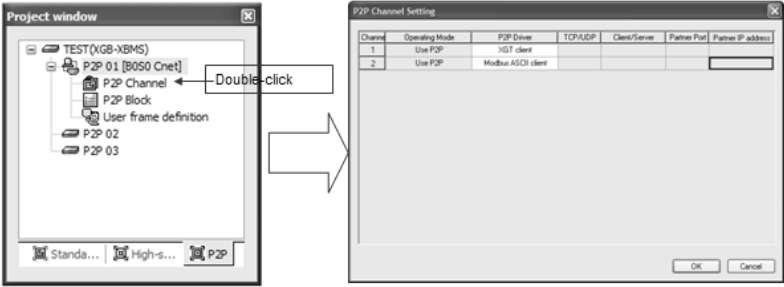

Sequence	Procedure	Setting method
1	Connection setting	
1. Select [Online]-[Connection Settings] or click icon () 2. Click [Connect] after setting.		
2	Read I/O information	Select [Online] – [Read I/O Information] or click icon () Reads the information about currently equipped module.
3	Standard Settings	
1. Double-click Cnet I/F module and execute standard setting window. Set Type, Speed, Data bit, Stop bit, station no. of connection menu. 2. Modem initialization is available in case of dial modem, not null modem. 3. Delay time setting: when sending frame, it sends frame after specific delay time. (a) Operation setting: Available when type is RS-422/485. * When using as Modbus ASCII server, data bit should be 7.		

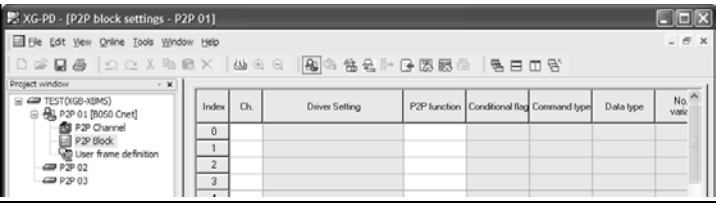
Sequence	Procedure	Setting method
4	Selecting the active mode	1. Select active mode of server for user to use. 2. XGB Cnet I/F module supports XGT server, Modbus ASCII server, Modbus RTU server.
5	Writing parameter	
		1. Select [Online] – [Write Parameter] or click icon () 2. Click [OK]. 3. If you click [OK] button, parameter is sent to PLC. If you don't reset relevant module, XGB Cnet I/F module acts as changed parameter.
6	Checking the operation	
		1. Select [Online] – [System Diagnosis] or click icon (). 2. Click the right button on the relevant module and click Frame Monitor or Status By Service to check

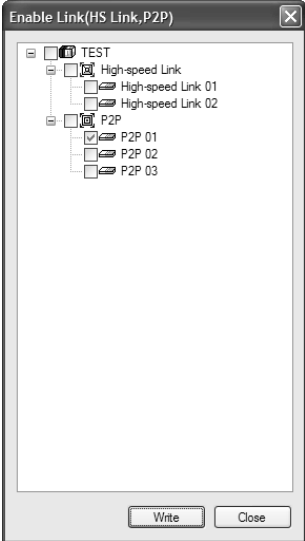
2.10.1.2 In case of acting as P2P service (client)

Sequence	Procedure	Setting method
1	Standard settings	1. Step 1~3 is same as described above. *In case of ASCII client, data bit should be 7.
2	Active mode	
		1. Select Use P2P settings as active mode.
3	P2P settings	
		1. After selecting P2P setting window, double-click P2P block address and input base and slot no. of communication module. 2. P2P 01 is fixed as built-in Cnet and base and slot is fixed as 0 and you can't change that.
4	P2P channel setting	
		1. Double-click P2P driver and select protocol according to each channel. 2. P2P driver supports user definition frame, XGT client, Modbus RTU/ASCII client.

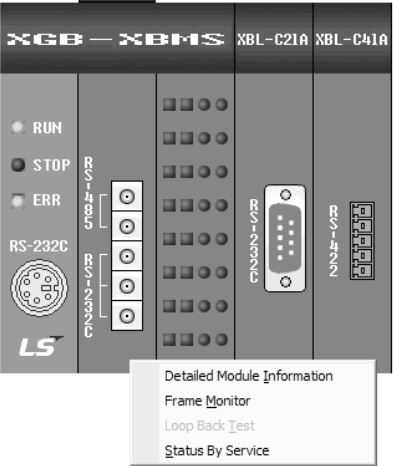
Sequence	Procedure	Setting method
5	P2P block setting	
<ol style="list-style-type: none"> 1. P2P items are activated differently according to type of client set in the channel. 2. Write shell according to protocol <p>* In case of user definition frame, P2P block can be set when user definition frame is written.</p>		
6	Writing parameter	
<ol style="list-style-type: none"> 1. Select [Online] – [Write Parameter] or click icon (). 2. Click [OK]. 3. If you press [OK], parameter is sent to PLC. <p>If you don't reset relevant module, XGB Cnet I/F module acts as changed parameter.</p>		
7	Enabling the link	
<ol style="list-style-type: none"> 1. Select [Online] – [Enable Link] or click icon (). 2. Click the P2P to enable and click Write. 		

Sequence	Procedure	Setting method
8	Checking the operation	 <p>The screenshot shows the XGB-XBMS control panel with modules XBL-C21A and XBL-C41A. A context menu is open over the XBL-C21A module, listing options: Detailed Module Information, Frame Monitor, Loop Back Test, and Status By Service.</p>
<ol style="list-style-type: none"> 1. Select [Online] – [System Diagnosis] or click icon (). 2. Click the right button on the relevant module and click Frame Monitor or Status By Service to check. 		

2.10.2 Dedicated Communication Example

About Dedicated communication

- As defined protocol by LS ELECTRIC, it is classified XGT client and XGT server
- XGT client: requests reading/writing of data to server
- XGT server: responds according to request of client

We assume that system configuration of dedicated service example is as [Figure 2.11.1] and communication setting is as following table.

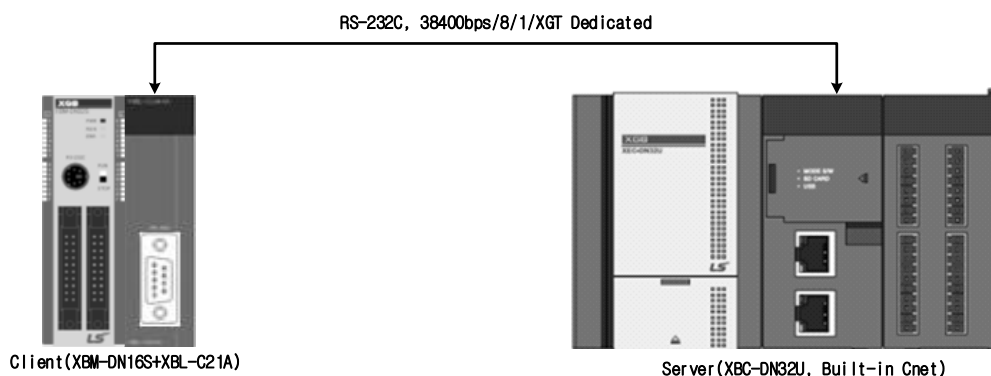

[Figure 2.11.1] Example of dedicated service system configuration

2.10.2.1 Client setting

Type	Setting content	
Main unit	XBM-DN16S	
Communication module	XBL-C21A (1 slot)	
Communication type	RS-232C	
Communication speed	38,400	
Data bit	8	
Stop bit	1	
Parity bit	None	
Modem type	Null modem	
Operation cycle	200ms	
Operation status	Write	Saves 1 word of M100 at client to M100 at server
	Read	Saves 1 word of D100 at server to M110 at client

[Table 2.11.1] client setting



2.10.2.2 Server setting

Type	Setting content
Main unit	XBC-DN32H
Communication module	Main unit built-in (RS-232C)
Communication type	RS-232C
Communication speed	38,400
Data bit	8
Stop bit	1
Parity bit	None
Modem type	Null modem
Station no.	1

[Table 2.11.2] Server setting

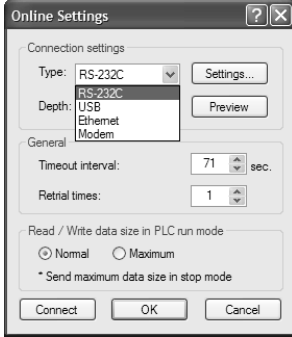

2.10.2.3 Settings of XGT server

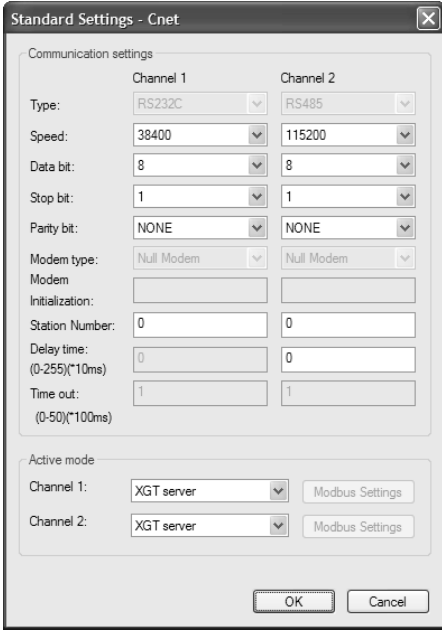
Setting method to operate built-in RS-232C communication channel of XBC-DN32H as server is as follows.





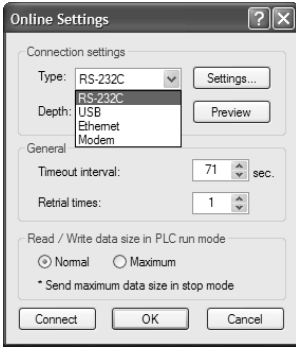

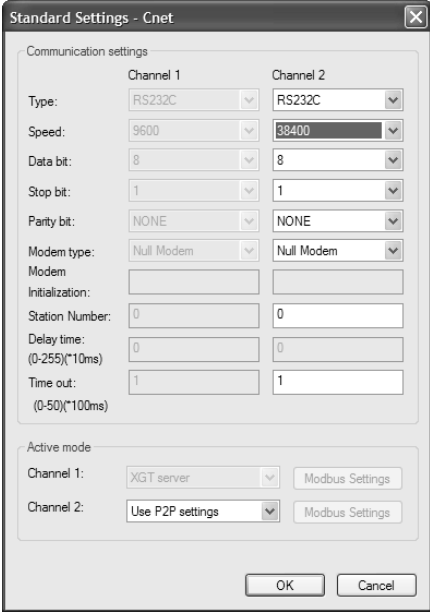
Sequence	Procedure	Setting method
1	Connection settings	
		<p>1. Select [Online]-[Connection settings] and click ().</p> <p>2. After setting the connection option according to user, click the 'connection'.</p>
2	Reading IO information	Select [Online]-[Read IO Information] and click icon (). IO information of currently mounted is shown on the project window.
3	Standard settings	
		<p>1. Set standard settings at built-in communication channel to be same with [Table 10.2.2]'s standard settings.</p> <p>2. Since active mode acts as dedicated communication server, set as XGT server.</p>



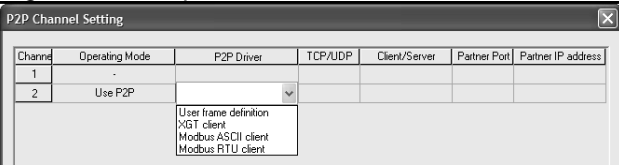

2.10.2.4 Settings of XGT client

To operate XBL-C21A of client as XGT client, set Cent I/F module as follows.

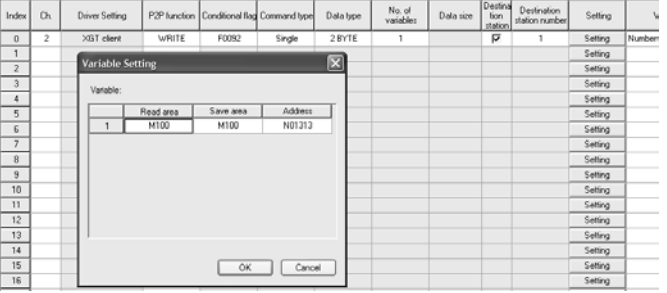
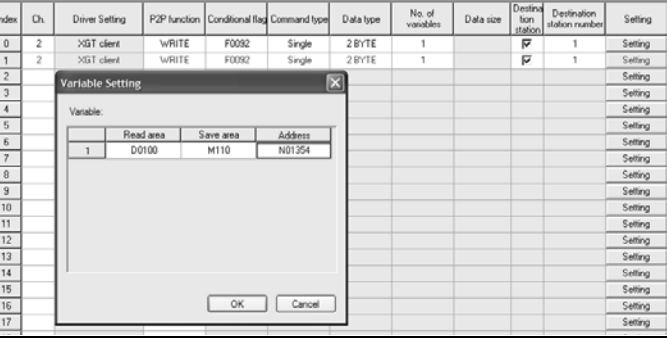
Sequence	Procedure	Setting method
1	Connection settings	
		<ol style="list-style-type: none"> 1. Select [Online]-[Connection settings] or click icon (). 2. After setting the connection option according to user, click the 'connection'.
2	Reading IO information	Select [Online]-[Read IO Information] and click icon (). IO information of currently mounted is shown on the project window.
3	Standard settings	
		<ol style="list-style-type: none"> 1. Select XBL-C21A and set standard setting at channel 2 to be same with setting described in [Table 2.11.1]. 2. In case of acting as client, station setting doesn't have the meaning so set temporary station (0~255). 3. When acting as client, active mode should be [Use P2P settings].

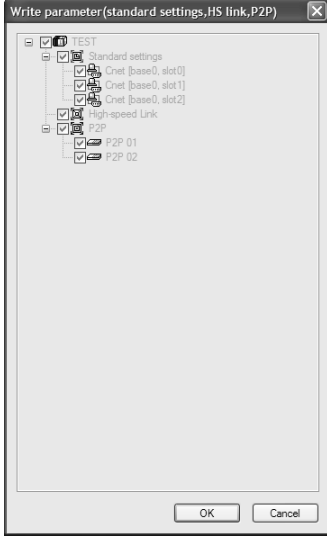

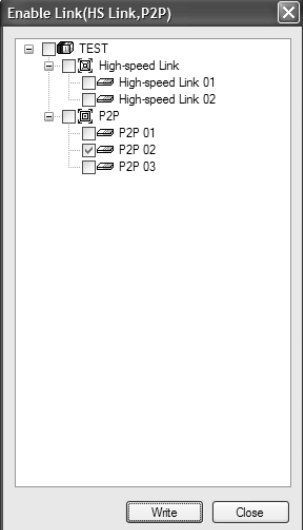
After standard settings, P2P channel and P2P block should be set. Setting methods are as follows.

Sequence	Procedure	Setting method
1	P2P setting	Click  P2P bottom of project window.
2	Communication module settings	
	1. Double-click  of project window. (P2P 01 is fixed as built-in communication module) 2. Select slot number (no. 1) acting as client and press OK.	
3	P2P channel setting	
	1. Double-click  of P2P 02 and set P2P driver of channel 2 as 	
4	1. Double-click  of P2P 02.	
5	Setting of writing operation	
	1. Channel: Select ch.2 set as XGT client set in P2P channel. 2. Since it executes write operation, select WRITE. 3. Conditional flag: to send frame every 200ms, use flag F92. 4. Command type, Data type: to write 1 word, select single and 2 byte. 5. No. of variable: since no. of word is 1, select 1. 6. Destination station number: input 1 as station number of server. 7. Setting: after setting Read area and Save area, click OK. 1) Read area: device address of data saved in the client 2) Save area: device address of server to save data * If all settings are completed, color of index of channel becomes black.	
6	Setting of reading operation	
	1. Channel, conditional flag, command type, data type, No. of variable, destination station no.: Same as described in setting is writing. 2. P2P function: select READ. 3. Setting: after setting Read area and Save area, click [OK]. 1) Read area: device address of data saved in server 2) Save area: device address of client to save	

Sequence	Procedure	Setting method
7	Writing parameter	 <p>The screenshot shows a dialog box titled "Write parameter (standard settings, HS link, P2P)". It contains a tree view with the following items: TEST (checked), Standard settings (checked), Cnet [base], slot0 (checked), Cnet [base], slot1 (checked), Cnet [base], slot2 (checked), High-speed Link (checked), P2P (checked), P2P 01 (checked), and P2P 02 (checked). At the bottom are "OK" and "Cancel" buttons.</p>
<p>1. Select [Online] – [Write Parameter] or click icon (). 2. Click [OK]. 3. If writing parameter is complete After clicking [OK], changed parameter is applied automatically.</p>		
8	Enabling the link	 <p>The screenshot shows a dialog box titled "Enable Link(HS Link,P2P)". It contains a tree view with the following items: TEST (checked), High-speed Link (checked), High-speed Link 01 (unchecked), High-speed Link 02 (unchecked), P2P (checked), P2P 01 (checked), P2P 02 (checked), and P2P 03 (unchecked). At the bottom are "Write" and "Close" buttons.</p>
<p>1. Select [Online] – [Enable Link] or click icon () 2. Click the P2P to enable and click Write.</p>		

2.10.2.5 Checking the operation

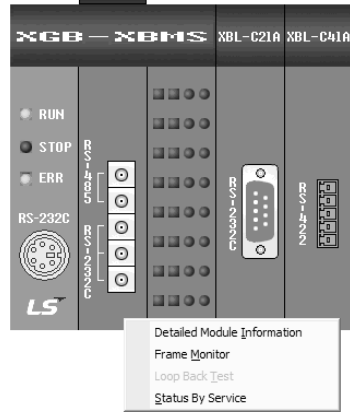
The user can analyze frame by using the frame monitor of XG-PD to check it communication is normal or not. Method of frame monitor of Cnet I/F module is same regardless of protocol.

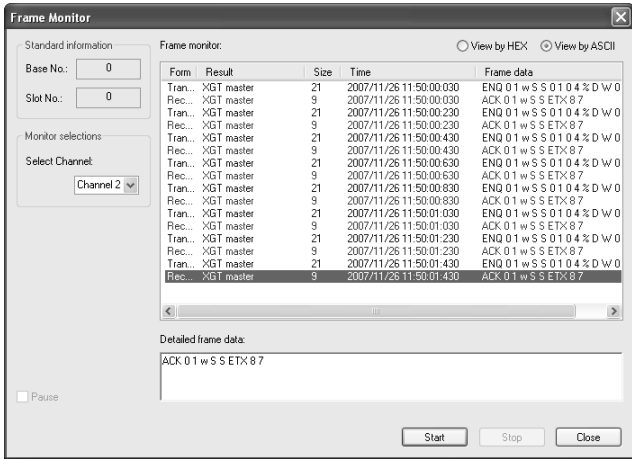
Sequence	Procedure	Setting method
1	System Diagnosis	
<p>1. Connect with client by XG-PD and select [Online] – [System Diagnosis] or click ().</p> <p>2. Click the right button on the relevant module and click Frame Monitor or Status By Service.</p>		
2	Frame monitor	
<p>1. Select channel 2 and click Start.</p> <p>2. Since dedicated service is ASCII communication, select View by ASCII.</p> <p>* In case of Modbus RTU, select View by HEX and in case of Modbus ASCII, select View by ASCII.</p>		

2.10.3 Modbus Communication Example

We assume that system configuration of Modbus communication (Modbus RTU mode) example is as [Figure 10.3.1] and communication setting is as following table.

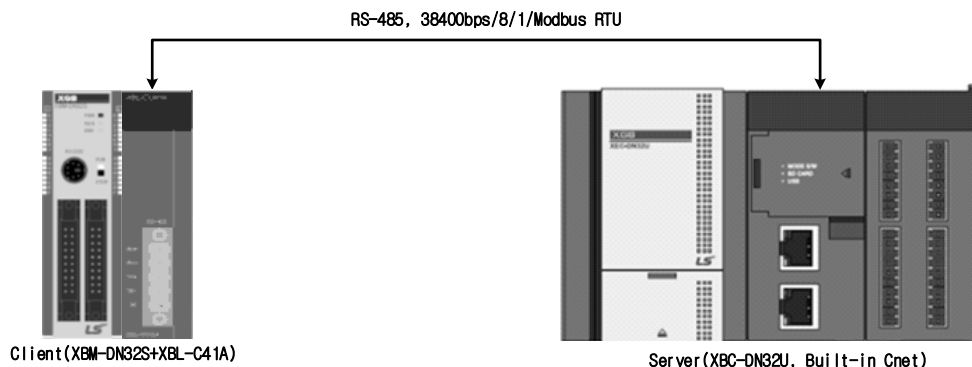

[Figure 2.11.2] XGT Modbus communication system configuration example

- Mount XBL-C41A on no. 1 slot of client PLC

2.10.3.1 Client setting

Main unit		XBM-DN32S
Communication module		XBL-C41A(no.1 Slot)
Communication type		RS-485
Communication speed		38,400
Data bit		8
Stop bit		1
Parity bit		None
Operation cycle		200ms
Operation status	Write	<ul style="list-style-type: none"> ▶ Write 1 word of M100 of client to M1 of server ▶ Write 4 words from D0 of client to M2~M5 of server ▶ Write 15th bit of M2 to 2nd bit of M20 of server ▶ Write 0~15th bit of M2 to 0~15th bit of M21 of server
	Read	<ul style="list-style-type: none"> ▶ Read 1 word of M2 of server and save it at M160 of client ▶ Read 4 words from P0 of server and save it at M150~M153 ▶ Read 1st bit of P2 of server and save it at 1st bit of M170. ▶ Read 0th ~ 15th bit of M10 of server and save it at 0th ~ 15th of M180 of client.

[client setting]



2.10.3.2 Server setting



Main unit		XBC-DN32H
Communication type		Built-in RS-485
Communication speed		38,400
Data bit		8
Stop bit		1
Parity bit		None
Station no.		1
Start address	Bit read area Address	P0
	Bit write area Address	M0
	Word write area Address	P0
	Word write area Address	M0

[server setting]

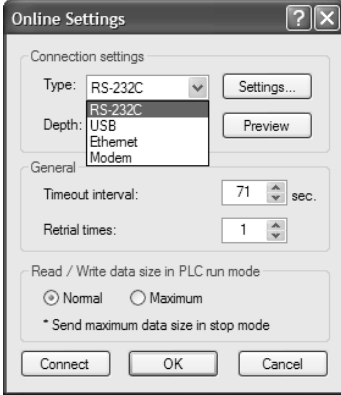
2.10.3.3 Modbus RTU server setting

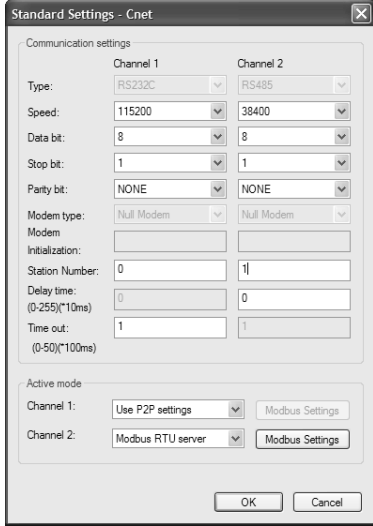
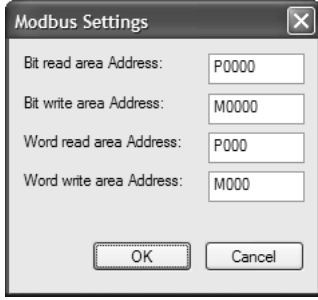

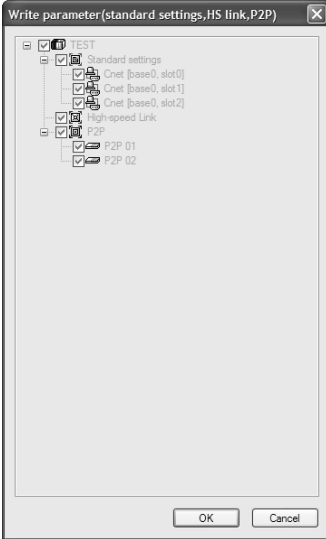
Standard settings are as follows to act built-in RS-485 communication channel of XBC-DN32H as Modbus RTU server.

Sequence	Procedure	Setting method
1	Connection setting	
		<ol style="list-style-type: none"> 1. Select [Online]-[Connection settings] or click icon () 2. After setting the connection option according to user, click the 'connection'.
2	Reading IO information	Select [Online]-[Read IO Information] and click icon (). IO information of currently mounted is shown on the project window.
3	Standard settings	
		<ol style="list-style-type: none"> 1. Write setting value as same with [Table 2.11.2] at built-in communication channel 1. 2. Set active mode as Modbus RTU server.
4	Modbus setting	
		<ol style="list-style-type: none"> 1. Bit read area Address: P0000 2. Bit write area Address: M0000 3. Word read area Address: P0000 4. Word write area Address: M0000 <p>* In the Bit read/write area Address, upper 4 digit is word address and the last digit is bit address (P00110: 0th bit of P11th word)</p>

Sequence	Procedure	Setting method
5	Writing parameter	
<ol style="list-style-type: none"> 1. Select [Online] – [Write Parameter] or click icon (). 2. Click [OK] 3. If writing parameter is complete after clicking [OK] button, changed parameter is applied automatically. 		

2.10.3.4 Setting of Modbus RTU client

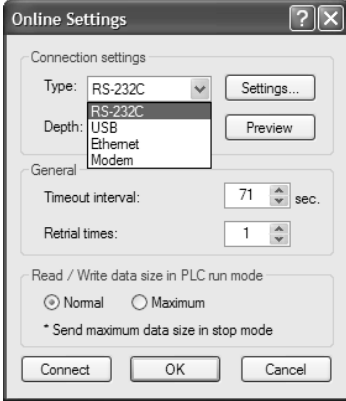
Standard settings are as follows to act XBL-C41A of client as Modbus RTU client.

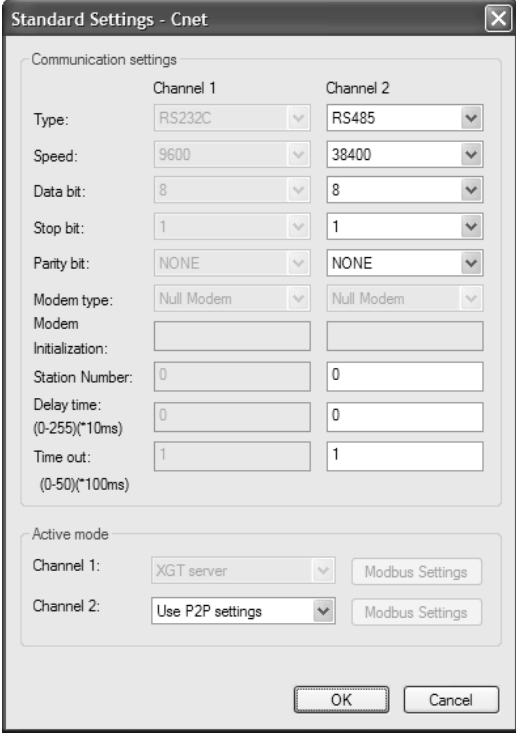



Sequence	Procedure	Setting method
1	Connection setting	
		<ol style="list-style-type: none"> 1. Select [Online]-[Connection settings] or click icon (). 2. After setting the connection option according to user, click the 'connection'.
2	Reading IO information	Select [Online]-[Read IO Information] and click icon (). IO information of currently mounted is shown on the project window.
3	Standard settings	
		<ol style="list-style-type: none"> 1. Select XBL-C41A and write standard settings to be same with [Table 2.11.1] at channel 2. Since station setting doesn't have meaning when acting as client, set as temporary station number (0~255). 3. When acting as client mode, active mode should be Use P2P settings.

After standard settings, P2P channel and P2P block should be set. Setting methods are as follows.

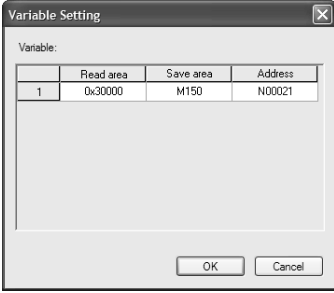
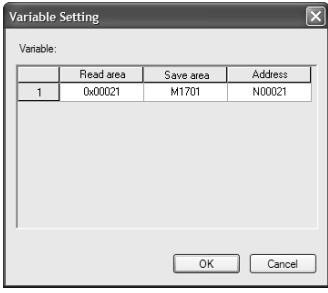
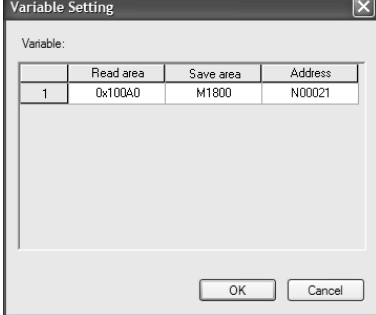
Sequence	Procedure	Setting method
1	P2P setting	Click P2P bottom of project window.
2	Communication module setting	
		1. Double-click of project window. (P2P 01 is fixed as built-in communication) 2. Select slot no. (No. 1) of client module and press OK.
3	P2P channel setting	
		1. Double-click of P2P 01 and set P2P driver of channel 1 as Modbus RTU client and click [OK].
4		1. Double-click of P2P 02.
5	Setting of writing operation (1)	
		▶ Write 1 word of M100 of client to M1 of server 1. Ch.: Select ch.2 set as Modbus RTU client set in P2P channel. 2. P2P function: select WRITE. 3. Conditional flag: to send frame every 200ms, use flag F92. 4. Command type, Data type: to write 1 word, select single and 2 byte. 5. Destination station number: select station number of server. 6. Setting: after setting Read area and Save area, click OK. (1) Read area: device address saved in the client (M100) (2) Save area: device address of server to save (0x40001: M1) * If all settings are completed, color of index of channel becomes black.
6	Setting of writing operation (2)	
		▶ Write 4 words from D0 of client to M2~M5 of server 1. Ch., P2P function, conditional flag, destination station no.: same with step 5 2. Command type, Data type: because of writing continuous 4words, select Continuous, WORD 3. Data size: because of 4 words, input 4. 4. Setting: after setting Read area and Save area, click OK. (1) Read area: device address saved in the client (D0) (2) Save area: device address of server to save (0x40002 : M2)

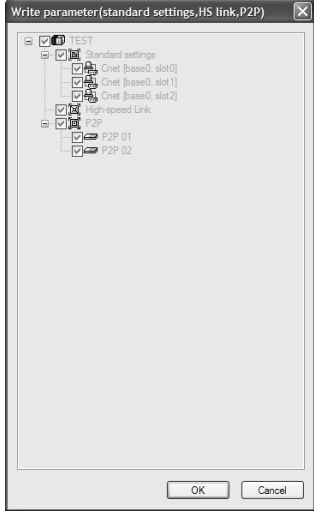
Sequence	Procedure	Setting method
7	Setting of writing operation (3)	
		<p>▶ Write 15th bit of M2 to 2nd bit of M20 of server</p> <ol style="list-style-type: none"> Ch., P2P function, conditional flag, destination station no.: same with step 5 Data type: select bit Setting: after setting Read area and Save area, click OK. <ol style="list-style-type: none"> Read area: device address saved in the client (M1.F : 15th bit of M1) Save area: device address of server to save (0x00142: 2nd bit of M20) <p>* When inputting M1.F, it is converted into M0001F in the XG-PD. * Device address of server is Hex value.</p>
8	Setting of writing operation (4)	
		<p>▶ Write 0~15th bit of M2 to 0~15th bit of M21 of server</p> <ol style="list-style-type: none"> Ch., P2P function, conditional flag, destination station no.: same with step 7 Command type: select continuous. Setting: after setting Read area and Save area, click OK. <ol style="list-style-type: none"> Read area: device address saved in the client (M2.0) Save area: device address of server to save (0x00150)
9	Setting of reading operation (1)	
		<p>▶ Read 1 word of M2 of server and save it at M160 of client</p> <ol style="list-style-type: none"> Ch., Conditional flag, Command type, Data type, Destination station no.: same with step 5 P2P function: select READ Setting: after setting Read area and Save area, click OK. <ol style="list-style-type: none"> Read area: device address saved in server (0x40002) Save area: device address of client to save (M0160)

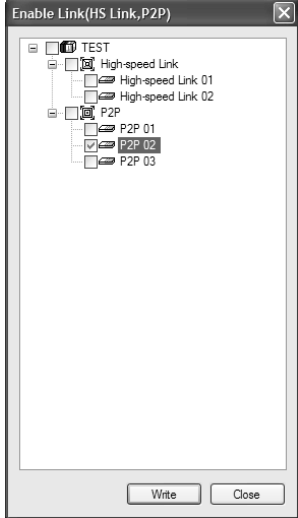
Sequence	Procedure	Setting method
10	Setting of reading operation (2)	 <p>► Read 4 words from P0 of server and save it at M150~M153</p> <ol style="list-style-type: none"> 1. Ch., Conditional flag, Command type, Data type, Destination station no.: same with step 6 2. P2P function: select READ. 3. Setting: after setting Read area and Save area, click OK. <ol style="list-style-type: none"> (1) Read area: device address saved in server (0x30000) (2) Save area: device address of client to save (M0150)
11	Setting of reading operation (3)	 <p>► Read 1st bit of P2 of server and save it at 1st bit of M170.</p> <ol style="list-style-type: none"> 1. Ch., Conditional flag, Command type, Data type, Destination station no.: same with step 7 2. P2P function: select READ 3. Setting: after setting Read area and Save area, click OK. <ol style="list-style-type: none"> (1) Read area: device address saved in server (0x00021) (2) Save area: device address of client to save (M170.1)
12	Setting of reading operation (4)	 <p>► Read 0th ~ 15th bit of M10 of server and save it at 0th ~ 15th of M180 of client.</p> <ol style="list-style-type: none"> 1. Ch., Conditional flag, Command type, Data type, Destination station no.: same with step 8 2. P2P function: select READ 3. Setting: after setting Read area and Save area, click OK. <ol style="list-style-type: none"> (1) Read area: device address saved in server (0x100A0) (2) Save area: device address of client to save (M180.0)

Sequence	Procedure	Setting method
13	Writing parameter	
<p>1. Select [Online] – [Write Parameter] or click icon ().</p> <p>2. Click [OK].</p> <p>3. If writing parameter is complete after click OK, changed parameter is applied automatically.</p>		
14	Enabling the link	
<p>1. Select [Online] – [Enable Link] or click icon ()</p> <p>2. Click the P2P to enable and click Write.</p>		

2.10.4 User-defined Communication Example

When communication with device of which protocol is not supported by Cnet I/F module client, how to use user-defined communication is described in the system like [Figure 2.11.3] below

- System configuration

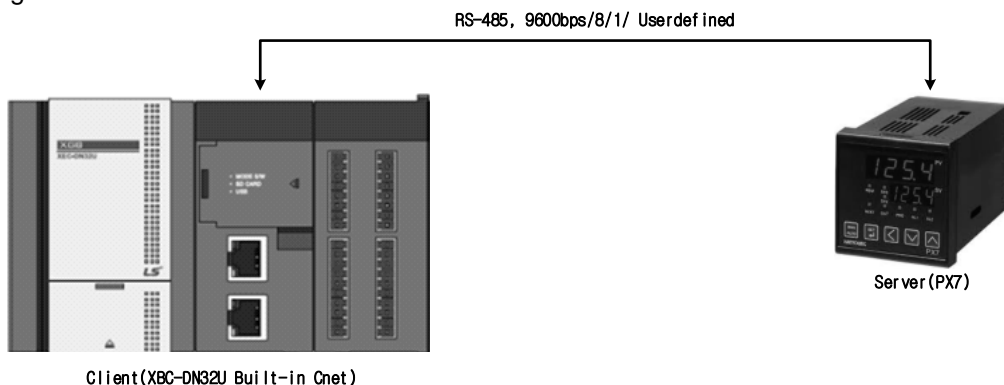

[Figure 2.11.3] User defined communication system configuration

At this example, Cnet I/F module and partner device to communicate through user defined communication system configuration are as Table below.

Device name	Main unit	XBC-DN32H	Han-Young temperature controller PX7* ^{Note2)}
	Communication module	Built-in RS-485	
Operation mode	Client		Server
Protocol	User frame definition		PC Link
Communication type	RS-485		RS-485
Communication speed	9,600		9,600
Data bit	8		8
Stop bit	1		1
Parity bit	None		None
Station no.	0		1
Delay time* ^{note1)}	100ms		-
Operation	Reads present value and setting value from temperature controller every second and saves present value at MB200 and setting value at MB210.		

[User defined communication system configuration]

Note1) Delay time is set to prevent from frame error when communication with device of which response is slow in case of RS-422/485 communication. It varies according to partner device and it has 50~100ms value generally.

1) User definition communication frame structure

Frame structure of PC Link, communication protocol of Han-Young used in this example, is as follows.

- Frame of temperature controller is executed as ASCII character string, it can read/write defined D, I Register. There are two protocols, STD standard protocol and SUM protocol adding Check Sum to standard type and protocol is selected by parameter of temperature controller. Standard protocol is STD". It starts with first character STX (0x02) and ends with last character CR(0x0D) LF(0x0A).

The following [Table 2.11.3] and [Table 2.11.4] indicates structure of standard protocol and Sum protocol.

STX	Station no.	Command	Data	CR	LF
0x02	1~99			0x0D	0x0A

[Table 2.11.3] standard protocol structure

STX	Station no.	Command	Data	Error code	CR	LF
0x02	1~99			Check Sum	0x0D	0x0A

[Table 2.11.4] SUM protocol structure

2) Writing example frame

In this example, present value and setting value is saved in M device area of PLC. [Table 2.11.5] is frame requesting continuous data and [Table 2.11.6] is frame responding to request.

Frame	STX	Station no.	DRS	,	No. of data	Start address of D register	CR	LF
(Byte)	1	2	3	1	2	4	1	1

[Table 2.11.5] request frame

- **DRS:** command that request reading continuous D register value. No of data and start address of D register is necessary.
- In the example, no. of data is 2 and start address is 01.

Frame	STX	Station no.	DRS	,	OK	,	Data 1	,	Data N	CR	LF
Size (Byte)	1	2	3	1	2	1	4	1	4	1	1

[Table 2.11.6] response frame



3) User definition communication parameter setting



(1) Communication standard parameter setting

For standard setting, refer to setting method when acting as P2P service of 2.10.2 and configure above system [Table 2.11.1].

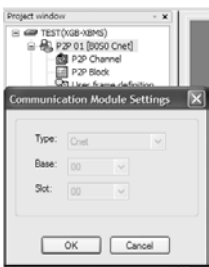
(2) Writing frame that requests reading data

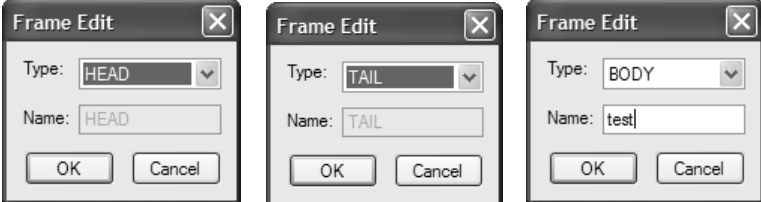
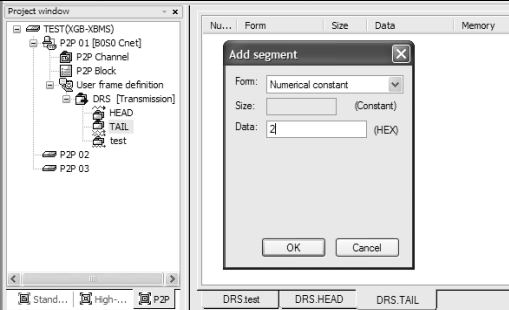
Describes how to write frame at XG-PD for user definition communication

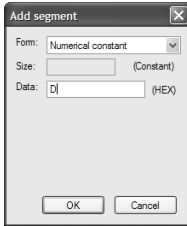
frame that requests reading data (Transmission frame)	
Sequence	Setting method
1	 <p>1. After standard settings, double-click [P2P 01] in the [P2P] window. 2. As for built-in communication, base and slot is fixed as 0. Click OK. 3. Double-click [P2P Channel] and select [User frame definition] in [Channel 2].</p>
2	 <p>1. Click user definition frame and click right button of mouse. 2. Click 'Add Group' and input group name (DRS) and select frame type as transmission.</p>
3	 <p>1. Click 'Add Frame' and select type HEAD, TAIL, BODY and input BODY name 2. BODY's name is test here.</p>
4	 <p>1. If you double-click editor window after selecting DRS.HEAD tap at right screen, segment setting screen is created. 2. Select Numerical constant which indicates Hex as ASCII code as Form. Input Hex value 2 which indicates STX.</p>

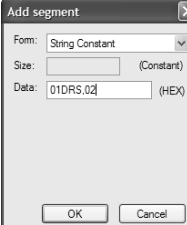
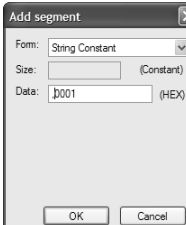
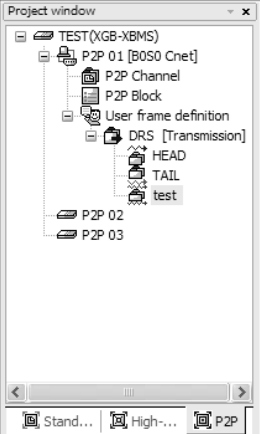
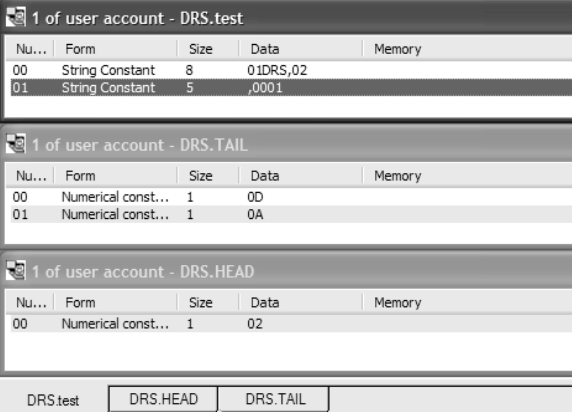
Sequence	Setting method
5	<div style="display: flex; justify-content: space-around;">   </div> <p>1. Select Numerical constant which indicates Hex as ASCII code as Form. Input Hex value D, A which indicates CR and LF.</p>
6	<div style="display: flex; justify-content: space-around;">   </div> <p>1. Double-click DRS.test tap and edit segment like the following. 2. Write frame requesting reading data of continuous 2 areas starting first of D register of station no.1. 3. When double-clicking editor screen and writing frame through segment edition, size of one segment is less than 10.</p>
7	<div style="display: flex;"> <div style="flex: 1;">  </div> <div style="flex: 2;">  </div> </div> <p>1. Result writing entire frame of data reading request frame.</p>

4) Writing frame to receive response frame of temperature controller

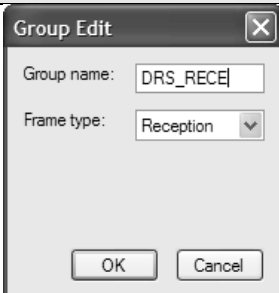
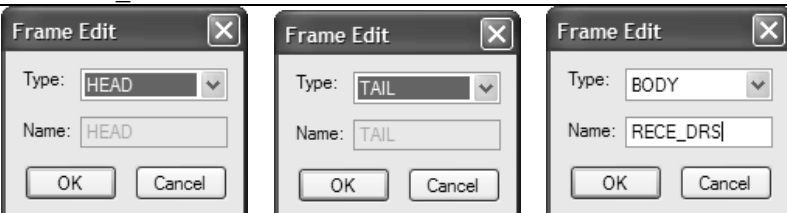
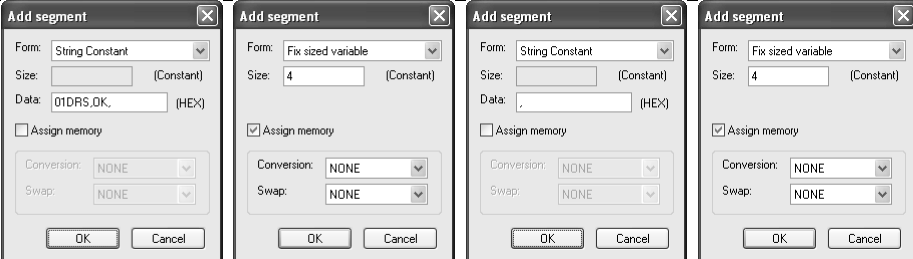
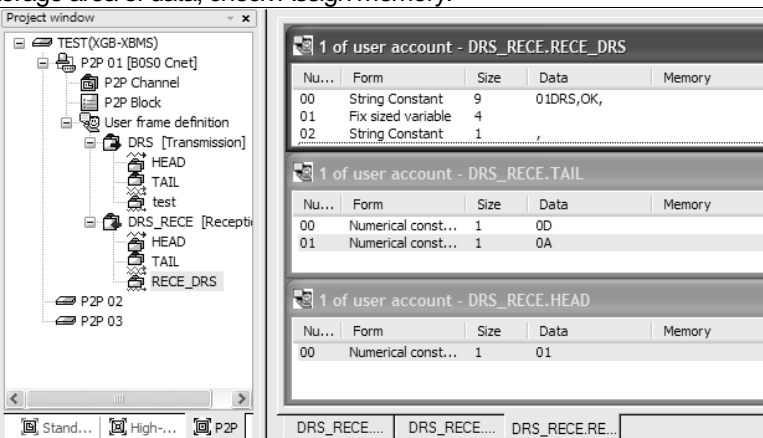
Writing response frame (Reception frame)	
Sequence	Setting method
1	 <p>1. Write like step 2 of frame that request reading data. At this time, set Frame type as reception. 2. Frame name is DRS_RECE.</p>
2	 <p>1. Click 'Add Frame' and select HEAD, TAIL, BODY as type and input BODY name. 2. BODY's name is RECE_DRS here.</p>
3	<p>1. Method writing HEAD, TAIL is same with step 4~5 of method writing frame that request reading data.</p>
4	 <p>1. To save present temperature value in MB200 and setting value in MB210, set the storage area of 1st and 2nd data as set in [Table 10.4.1]. 2. Since data size of data 1 and 2 is 4 byte, select Fix sized variable and input 4 in Size 3. To select storage area of data, check Assign memory.</p>
5	 <p>1. This is entire frame to receive response data of temperature controller.</p>

5) Writing P2P transmission/reception block

Write P2P TX/RX block as follows by using user definition communication segment written ahead.

Sequence	Setting method
1	
	<ol style="list-style-type: none"> 1. Double-click P2P block of P2P 01. 2. Input channel selected at P2P channel (user frame definition). 3. In case P2P function is TX frame, select SEND. In case P2P function is RX, select RECEIVE. 4. Conditional flag is activated when P2P function is SEND. 5. Since it reads data every 1 second, use F93 as conditional flag. 6. Click Setting of RX frame and set save area of current temperature and setting value.
2	Execute Write Parameter and Enable Link.

6) Checking TRX data

Check whether written frame is transmitted/received properly

Sequence	Setting method
1	
	<ol style="list-style-type: none"> 1. Select [Online]-[System Diagnosis] or click icon () 2. After clicking relevant module and click right button of mouse, select Status by service or frame monitor. 3. When frame is not dealt with properly, unknown message is displayed.
2	Check device area by device monitor of XG-5000.

2.11 Error Code

2.11.1 XGT Server Error Code

Error code is displayed as hex 2 byte (4 byte as ASCII code). The user can see error by frame monitor and in case of viewing by ASCII, the user can see the following error code.

Error code	Error type	Error details and causes	Example
0003	Number of blocks exceeded	Number of blocks exceeds 16 at Individual Read/Write Request	01rSS1105%MW10...
0004	Variable length error	Variable Length exceeds the max. size of 16	01rSS010D%MW100000000000 ..
0007	Data type error	Other data type than X,B,W,D,L received	01rSS0105%MK10
0011	Data error	Data length area information incorrect	01rSB05%MW10%4
		In case % is unavailable to start with	01rSS0105\$MW10
		Variable's area value wrong	01rSS0105%MW^&
		Other value is written for Bit Write than 00 or 01	01wSS0105%MX1011
0090	Monitor execution error	Unregistered monitor execution requested	
0190	Monitor execution error	Reg. No. range exceeded	
0290	Monitor reg. Error	Reg. No. range exceeded	
1132	Device memory error	Other letter than applicable device is input	
1232	Data size error	Request exceeds the max range of 60 Words to read or write at a time.	01wSB05%MW1040AA5512,..
1234	Extra frame error	Unnecessary details exist as added.	01rSS0105%MW10000
1332	Data type discordant	All the blocks shall be requested of the identical data type in the case of Individual Read/Write	01rSS0205%MW1005%MB10
1432	Data value error	Data value unavailable to convert to Hex	01wSS0105%MW10AA%5
7132	Variable request area exceeded	Request exceeds the area each device supports.	01rSS0108%MWFFFFFF

2.11.2 Modbus Server Error Code

Error code is displayed as hex 1 byte (2 byte as ASCII code) and indicates type of error.

Code	Error type	Error details and causes
01	Illegal Function	Function code error
02	Illegal Address	Address range exceeded
03	Illegal Data Value	Data value not allowed

2.11.3 P2P Client Error Code

Code	Error type	Error details and causes
01	ERR_NO_HEAD	There is no head of reception frame
02	ERR_NO_TAIL	There is no tail of reception frame
03	ERR_WRONG_BCC	BCC is not correct
04	ERR_STATION_NO	Station number of reception frame is not correct
05	ERR_WRONG_DRV_TYPE	Driver type is not correct
07	ERR_FRAME_SND	Can't send TX frame
09	ERR_NO_USE_LINKID	There is no communication module
0A	ERR_PLC_RESP_TIMEOUT	Reception frame is not received during time out setting time
0B	ERR_FRM_LENGTH	Length of reception frame is not correct
0D	ERR_ASCII_HEX_ERR	ASC-HEX conversion of reception frame is not correct
0E	ERR_RANGE_OVER	Area of device is exceeded
0F	ERR_NAK_ERR	Response of reception frame is NAK

Chapter 3 Web Server

3.1 Outline of the Web Server

The web server is the function embedded in XGB high-performance PLC series. Through a web browser, a user can access to the web server that is in the PLC. In addition, several users can access to the web server at the same time. Through the web server, you can monitor the diagnosis information such as the basic information, error history, mode switching history, etc. of the PLC. The web server also provides the functions to monitor and control the PLC's flags or data. Furthermore, through a wide variety of functions, a user can freely make the web page and control the PLC and download the data log file from the PLC.

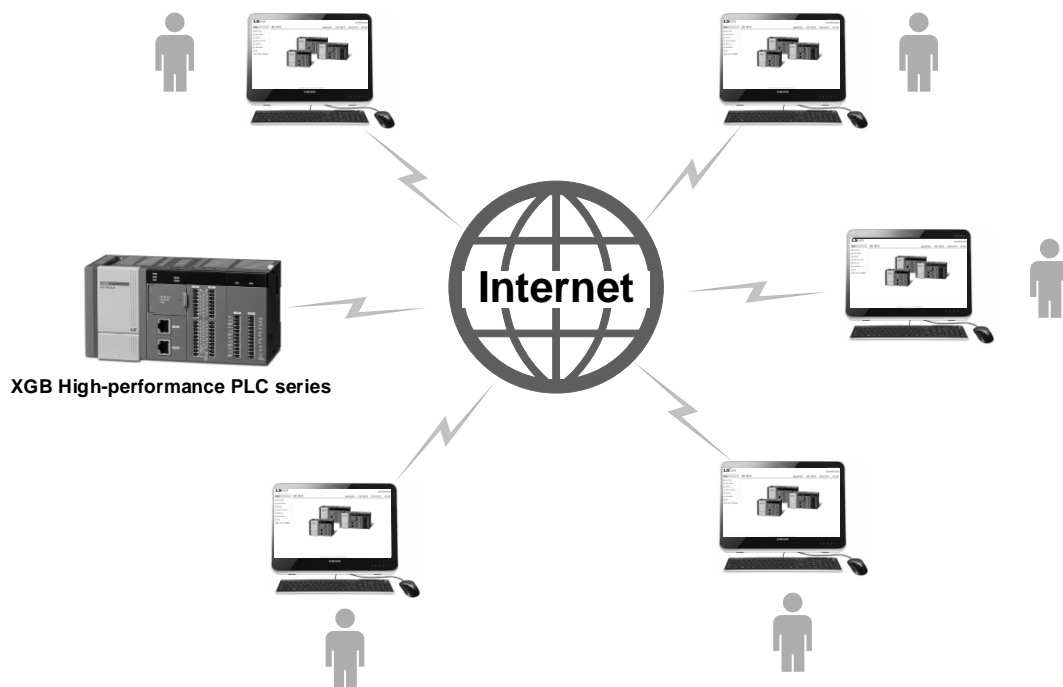

3.1.1 Characteristics

The web server has the below characteristics.

1) Monitoring the module's basic information

You can remotely monitor the basic information or state information and details on the PLC through a web browser. In addition, you can RUN or STOP the PLC remotely when contacting the web server with administrator authorization.

2) Monitoring diagnosis information

You can remotely monitor error history, mode switching history, system history, power down history, web access history, E-mail history, communication service history of the PLC.

3) Device monitoring

You can monitor and modify the devices and system flags of the PLC respectively.

4) Management of data log file

You can remotely download the data logging file saved to the SD card from the PLC by using a web browser.

5) Web page used by a user

A web server user can control or monitor the PLC as he/she likes by making the web page directly.

Chapter 3 Web Server

3.1.2 Software for use

It describes the main programming and manufacturing software to use the embedded web server. To apply programs and communication properly, prepare the below and refer to the instructions for the system.

1) Setting software

Software for setting parameters	Available web server version
XG5000	4.0 or higher

2) Basic unit's OS version

Basic unit type	Available web server version
XBC-xxxxUx	1.1 or higher
XEC-xxxxUx	1.1 or higher

3) Web browser version

Web browser version	Available web server version
Internet Explore	9.0 or higher
Chrome	38.0.2 or higher
Firefox	30.0 or higher

Notice

(1) You can download the parameters setting program from the website.

Web address: <http://www.ls-electric.com/>

(2) It can be programmed by the USB port of the basic unit. For the type of available cables, please refer to the wiring of the manual.

(3) If you use the products other than available version depending on communication configuration by series, some functions may not work normally. Before use, please check the version.

3.2 Specifications

3.2.1 Communication Specifications

The below table shows you the communication specifications of the web server.

Item	Specification			
	Driver	Communication method	Port No.	Remarks
Web server	HTTP	TCP/IP	80	1) Up to 4 channels 2) Supporting HTTP 1.1

3.2.2 Function Specifications

The below table shows the function specifications of the web server.

Category	Function	Specification	
MAIN	Language Conversion	Conversion between Korean and English	
	Link to LS ELECTRIC's website	Link to Korean/English website	
	Manual Download	Link to the page for Korean/English Manual download	
	Communication setting	Change of TcpAckFrequency registry	
	Login	1) ID: Up to 8 characters 2) Password: Up to 8 characters	
BASIC INFO.	PLC's basic information	Name	Displaying the PLC's name
		IP address	Displaying the PLC's IP address
		Scan time	Displaying the PLC's scan time
	Web server's information	Web page information	Displaying the version and creation date of the web page
		Web page state	Displaying the web page's state
		Server load	Displaying the web server's load rate
	PLC's state information	State information	Displaying the PLC's state information
Operation mode		Changing the PLC's operation mode(RUN/STOP)	
PLC's detailed information	PLC's detailed information	Displaying the PLC's detailed information	
DIAGNOSTICS	ERROR LOG	Monitoring up to 100EA of history	
	MODE LOG	Monitoring up to 100EA of history	
	SYSTEM LOG	Monitoring up to 100EA of history	
	SHUT-DOWN LOG	Monitoring up to 100EA of history	
	WEB ACCESS LOG	Monitoring up to 100EA of history	
	E-mail LOG	Monitoring up to 25EA of history	
	COM-SERV. LOG	Monitoring up to 100EA of history	

Chapter 3 Web Server

Category	Function	Specification
Device MONITOR	DEVICE	1) Individual monitoring: Monitoring 10 devices by account 2) Integrated Monitoring: Monitoring 10 devices for all integrated accounts 3) Refresh cycle: N/A, 10 seconds, 20 seconds, 30 seconds, 1 minute
	FLAG	1) Individual monitoring: Monitoring 10 devices by account 2) Integrated monitoring: Monitoring 10 devices for all integrated accounts 3) Refresh cycle: N/A, 10 seconds, 20 seconds, 30 seconds, 1 minute
DATALOG	Downloading the data log file from the PLC	1) Displaying the data log files up to 256EA 2) A maximum of 10 data log folders can be accessible.
USER PAGE	User page view	User page URL: http://xxx.xxx.xxx.xxx/userpage/home.html (xxx means the web server's IP address.)
SETTING	User account setting	1) Account can be registered up to 15EA. 2) ID : Less than 8 characters 3) password: Less than 8 characters
	IP filtering	1) IP Block: Registering a maximum of 15 blocking IP ranges 2) IP Allow: Registering a maximum of 15 allowable IP ranges
	Time setting	Synchronization with the local time or manual time setting (When SNTP is not used)
	Registration of user page	Final executable file name of the user page: Home.html

3.2.3 Web Server performance table

The following table shows loading time and scan time increment when using web server and data logging functions at the same time. Please refer to web server and data log used at the same time.

1) Scan time : 1ms/10ms

Scan time(ms)	STOP	1ms				10ms			
		Not Used	1group	5group	10group	Not Used	1group	5group	10group
Datalog group numbers	_	Not Used	1group	5group	10group	Not Used	1group	5group	10group
Scan time increment(ms)	-	4.2	4.9	3.3	3.7	3.3	5.9	5.4	3.3
Web server load time(s)	2.79	3.12	3.52	7.24	7.49	7.53	7.63	10.72	15.19

2) Scan time : 50ms/100ms

Scan Time(ms)	50ms				100ms			
	Not Used	1group	5group	10group	Not Used	1group	5group	10group
Datalog group numbers	Not Used	1group	5group	10group	Not Used	1group	5group	10group
Scan time increment(ms)	3.9	2.2	3.2	3.1	3.7	3.0	4.1	2.9
Web server load time(s)	22.16	23.21	24.19	30.15	41.78	42.77	46.83	61.23

Notice

- (1) Using the web server may increase the scan time of the basic unit.
Scan time = Normal scan time + Max. 8msec

3.3 How to use the web server

To use the web server function of XGB high-performance module, you need to preset the parameters for the embedded FEnet module through XG5000 and send the web page file to the SD card. The preprocess for accessing to the web server is shown in the below chart.

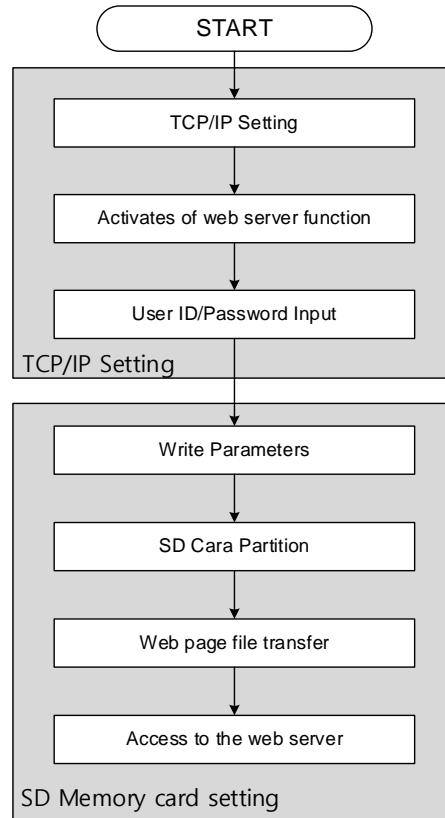

After setting the parameters of the embedded FEnet, you can access to the web server. In order to contact the web server, after connecting the PLC to Ethernet network, enter the IP set in XG5000 to the Internet Explore window.

3.3.1 TCP/IP Settings

To use the web server function, set the parameters of the embedded FEnet module as below procedures. For more details on FEnet parameters, refer to '1.6.2 Setting the basic parameters' of Chap.5 Embedded Communication Functions of XGB basic unit.

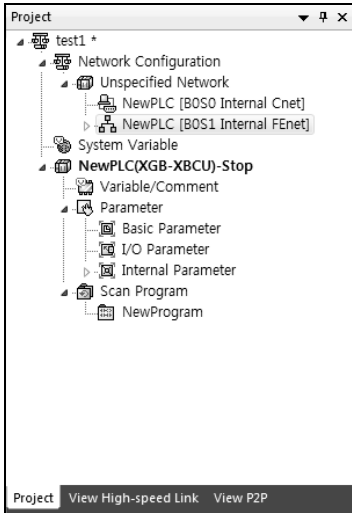
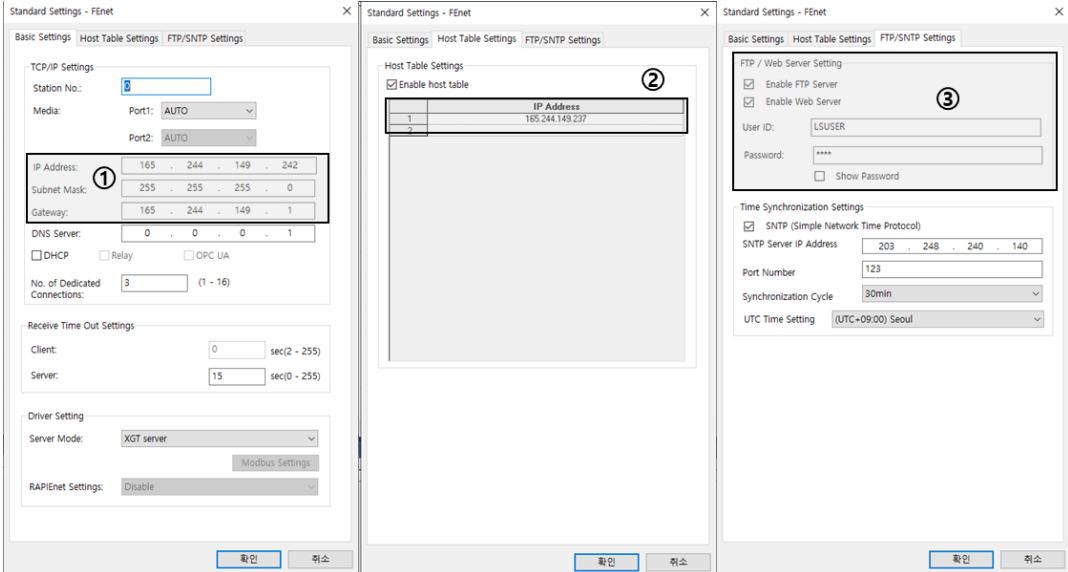
Procedures	Details	
1	Module selection	
<p>Double-click 'New PLC [[BOS1 Internal FEnet]' in the project window.</p>		
2		
1) IP address setting	<p>1) Enter the IP address, subnet mask, gateway, DNS server address. 2) This address can be commonly used for P2P service, high speed link service, remote service, FTP service, web server, etc.</p>	
2) Host table setting	<p>IP for emergency access [Note 1]</p>	
3) Activating web server function	<p>1. Check 'Activates the function of Web Server'. 2. Enter the user ID and password [Note 2].</p>	
4) OK	<p>If you click 'OK', the parameter settings for web server is completed.</p>	

Notice

[Note 1] If you cannot access to the web server due to wrong input of the IP in the IP filtering function during using the web server, enter the IP address for an administrator. Then, you can access to the web server in the PC regardless of IP filtering.

[Note 2] The default user ID and password is respectively LS ELECTRIC and 0000. If you want to see the password, check 'Show Password', you can check the set password.

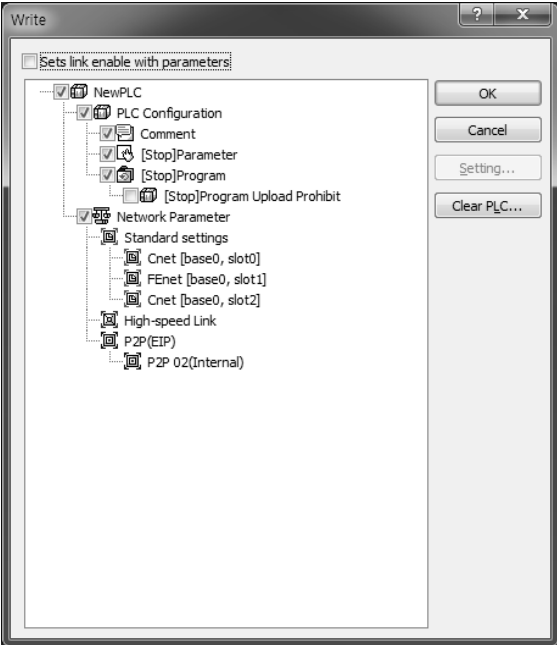
Procedures	Details	
3	Writing parameters	
<ol style="list-style-type: none"> 1. Click '[Online]' → [Write]' to write parameters to the PLC. 2. During executing [Write], if you check 'Set up with Link Enable', Link Enable can be applied with writing P2P/HS parameters at the same time. 		

3.3.2 Transferring the web page to the SD card

In order to use the web server, you need to transfer the web page file to the SD memory card through XG5000. Before sending the web page, first of all, you must split the SD card partition. If you send the web page to the SD card after splitting the SD card with XG5000, the web server is ready to use now.

1) SD Memory card format

You can split the SD card partition by using XG5000 as shown in the below procedures.

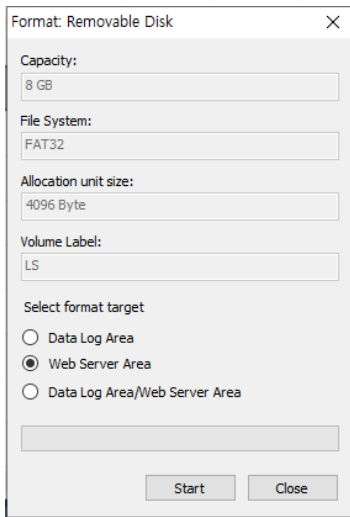
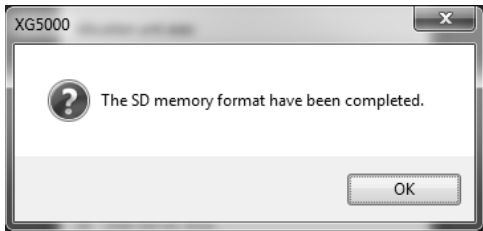
Procedures	Details	
1	Memory card format	
	<p>1) After running XG5000, access to the PLC. 2) After accessing to the PLC, click '[Online] → [Reset/Clear] → [SD memory] → [Format]'. 3) If you click '[Format]' button, the warning window will be created. If you click '[Yes]', the window for SD card format will be created.</p>	
2	Completion of format	
	<p>1) Click the '[Web server area]' button in the window for SD card format. - If the 'Web server area' is activated, it indicates the SD card partition is done. - If the SD card is already divided, you don't need to partition it again. 2) For partition, click '[Start]' button. 3) When format is done, the format completion window will be created.</p>	

Notice

- (1) To partition the SD memory card, you need to install the XG5000 that supports the partition function.
- (2) XG5000 version supporting the partition function: 4.0 or higher

Chapter 3 Web Server

2) Transferring the web page file to the SD card

To use the web server, you need to transfer the web page file to the SD card. If you want to do this, XG5000 is required. The below procedures show you how to transfer the web page file to the SD card.

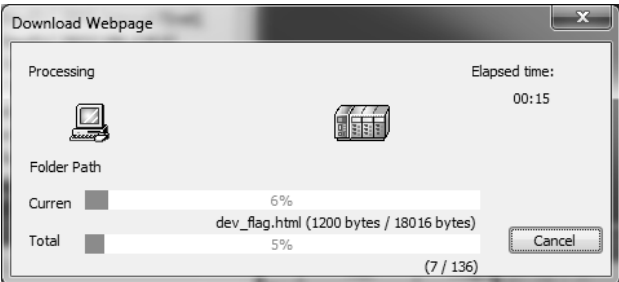
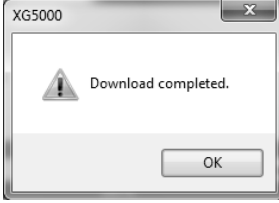
Procedures	Details	
1	Memory card format	 <p>1) After running XG5000, access to the PLC. 2) After accessing to the PLC, if you click 'Online' - 'Reset/Clear' - 'SD Memory' - 'Web Page Download' button, the window for transferring the web page file will be created and file transfer will start.</p>
2	Completion of format	 <p>1) When file transfer is done, the window indicating the web page file transfer is completed will be created. If you click the OK button, web page transfer will be completed.</p>

Notice

- (1) To transfer the web page to the SD card, you need the XG5000 that supports web page transfer.
- (2) XG5000 version supporting web page transfer: 4.0
- (3) The web page distinguishes XBC from XEC type so make sure to download the web page after setting the PLC's CPU type correctly.
- (4) If the web page file exists in the web server area, format the web server area first and then, download the web page.

3.3.3 Check web server is ready

bit	flag	description	Normal
K40070	_WS_Rdy	Web server ready(all case should be satisfied) -Activate web server(3.3.1 TCP/IP setting) -SD Partition division is normal (K40071:On) - Transferring the web page to the SD card succeeded.	On
K40071	_WS_Partition_Divide	SD card Partition division -Formatted data log/web server area (Execute if not divided, If divided, it keeps divided state)	On
K40072	_WS_File_Exist	Transferring the web page to the SD card succeeded.	On
K40078	_WS_Init_Error	Web server initialization error	Off

3.3.4 Access to web server

The following is about how to access to the web server.

- 1) Connect the PLC to the Ethernet network. (You can also connect the PLC to the PC directly)
- 2) After running a web browser, enter the IP set in XG5000 in a search window.
- 3) If you click 'Move' button after entering the IP, the web server's main page will be loaded as shown below.



[Fig. 3.3.3.1] web server login page

3.3.5 How to initialize the web server

It is the way for a user to initialize the web server's data.

- 1) After accessing to the PLC through XG5000, click '[Online] → [Reset/Clear] → [Clear All PLC..]' in the XG5000 Online menu as shown in [Fig. 3.3.4.1].

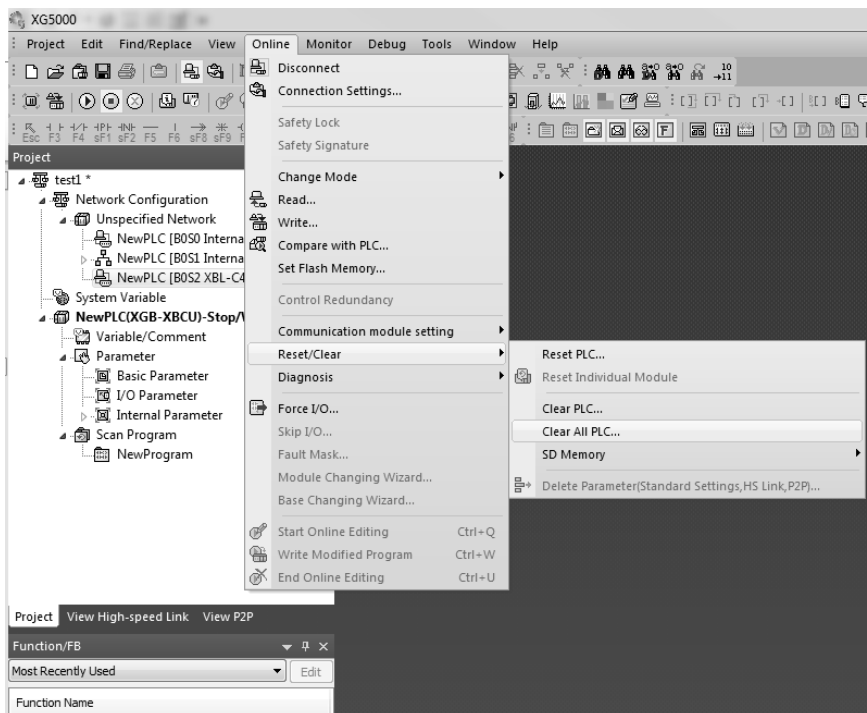

[Fig. 3.3.4.1] Clear all PLC data

- 2) If you click the button, the warning message will pop up as shown below.

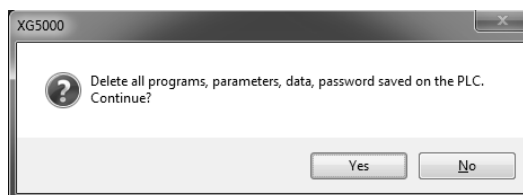

- 3) If you click the 'Yes' button, all programs, parameters, passwords, data of the PLC (including web server data) will be deleted.

Notice

- (1) As described above, 'Delete All PLCs' deletes not only the web server data but also PLC's data so try not to use this function.
- (2) If you click 'Delete All PLCs', the PLC's parameters and programs, etc. will be all deleted. Accordingly, after deletion, you need to apply 'Rewrite Parameters and Programs' for normal operation.

3.4 Functions of the web server

The web server provides a wide variety of functions; diagnosis, monitoring, control, etc. Before using the web server, read and fully understand the following description on the web server's functions.

3.4.1 Description on general functions of the web server

It describes the functions of the web server with limitations depending on authority. The general functions of the web server are simply described. In terms of limitations on functions depending on authority, the functions are divided into available and unavailable ones based on login rights.

1) Functions supported by the web server

Category	Division	Name	Description
MAIN	MAIN	Communication setting guide	Describing how to establish the communication setting items
		Korean/English	Converting the web page's language(Korean, English)
		LS ELECTRIC HOME PAGE	Moving to LS ELECTRIC's website
		MANUAL DOWNLOAD	Moving to the manual download page
		COMM. SETTING	Improving communication performance by changing the registry
	Login	Login	Login to the web server
		Logout	Logout of the web server
BASIC INFO.	PLC Basic Information	Name	Displaying the PLC's name
		IP address	Displaying the PLC's IP address
		Scan time	Displaying the PLC's scan time
	WEBSERVER Information	Web page information	Displaying the version and creation date of the web page
		Web page state	Displaying the web page's state
		Server load	Displaying the web server's load rate
	PLC State Information	Operation Mode	Changing the PLC's operation mode(RUN/STOP)
		Operation State	Displaying the PLC's state information
	PLC Detailed Information	PLC Detailed information	Displaying the PLC's detailed information

Chapter 3 Web Server

Category	Division	Function	Description
DIAGNOSTICS	PLC history view	ERROR LOG	Monitoring the PLC's error history and Deleting error histories
		MODE LOG	Monitoring the PLC's mode switching history and Deleting the PLC's all mode switching histories
		SYSTEM LOG	Monitoring the PLC's system history and Deleting the PLC's all system histories
		SHUT-DOWN LOG	Monitoring the PLC's power down history and Deleting the PLC's all power down histories
	WEB ACCESS LOG	Web access history	Monitoring the history of users that access to the web server and Deleting all web access histories
	E-mail LOG	E-mail history	Monitoring the history of E-mails sent by the PLC and Deleting all E-mail transfer histories
	COM-SERV. LOG	Communication service history	Monitoring the embedded communication module's P2P communication service history
DEVICE MONITOR	DEVICE	Device monitoring	Monitoring the PLC's device values
	FLAG	System flag monitoring	Monitoring the PLC's system flag values
DATALOG	Data log	Data log file download	Downloading the data log file saved to the SD-card
USER PAGE	User page	User page	Using the user page
SETTING	User account setting	User account setting	Function to register, edit, delete users for login permission by authority
	IP filtering setting	IP filtering setting	Function to register, edit, delete IPs that are blocked or can access to the web server
	Time setting	Time synchronization setting	Setting the PLC's time synchronization function
	User page	User page setting	Registering the user page in the SD card, deleting and downloading the user page to the web browser

2) Limitations on functions depending on authority permissions

The web server largely has authority permissions for Administrator, User, Guest. The administrator has the rights to use all functions such as web server settings and monitoring, etc. A general user can use the functions such as device monitoring, user page, etc. except PLC operations and settings. A guest that accesses to the web page but does not log in yet can monitor the module's basic information, diagnosis information and integrated devices registered by the administrator or general users. The available functions in accordance with authority permissions are as shown below.

- Legend : ○(Available), X(Not available), △(Used restrictively), -(Unrelated)

Large category	Middle category	Function	Administrator	User	Guest
MAIN	MAIN	Communication setting guide	○	○	○
		Language Conversion	○	○	○
		LS ELECTRIC website link	○	○	○
		Manual download	○	○	○
		Communication setting	○	○	○
	Login	Login	-	-	-
		Logout	-	-	-
BASIC INFO.	PLC Basic Information	Name	○	○	○
		IP address	○	○	○
		Scan time	○	○	○
	WEBSERVER Information	Web page information	○	○	○
		Web page state	○	○	○
		Server load	○	○	○
	PLC State Information	Operation Mode	○	X	X
		Operation State	○	○	○
	PLC's detailed information	Module information	○	○	○
DIAGNOSTICS	PLC history view	ERROR LOG	○	○	○
		Delete all error histories	○	X	X
		MODE LOG	○	○	○
		Delete all module switching histories	○	X	X
		SYSTEM LOG	○	○	○
		Delete all system histories	○	X	X
		SHUT-DOWN LOG	○	○	○
		Delete all power down histories	○	X	X
	WEB ACCESS LOG	WEB ACCESS LOG	○	○	○
		Delete all web access histories	○	X	X
	E-mail LOG	E-mail LOG	○	○	○
		Delete all E-mail histories	○	X	X
	COM-SERV. LOG	Communication service history	○	○	○

Chapter 3 Web Server

Large category	Middle category	Function	Administrator	General	guest
DEVICE MONITOR	Device monitoring	Device monitoring	○	○	△
	System flag monitoring	System flag monitoring	○	○	△
DATALOG	Data log	Data log file download	○	○	X
USER PAGE	User page	User page	○	○	X
SETTING	User account setting	User account setting	○	X	X
	IP filtering setting	IP filtering setting	○	X	X
	Time setting	Time synchronization setting	○	X	X
	User page	User page setting	○	X	X

Notice

- (1) The guest can monitor the devices registered in the integrated monitoring
(However, there is not right to add, edit, change values, delete)
- (2) Time setting is available only when SNTP setting is unchecked. (You can uncheck SNTP in XG5000)

3.4.2 MAIN page

The MAIN that is the initial screen displayed when you access to the web server for the first time is composed of Language Conversion(Korean/English),LS ELECTRIC's website, manual download and communication setup. In addition, when you access to the web server for the first time, a pop-up will come on to provide guidelines to improve communication speed.

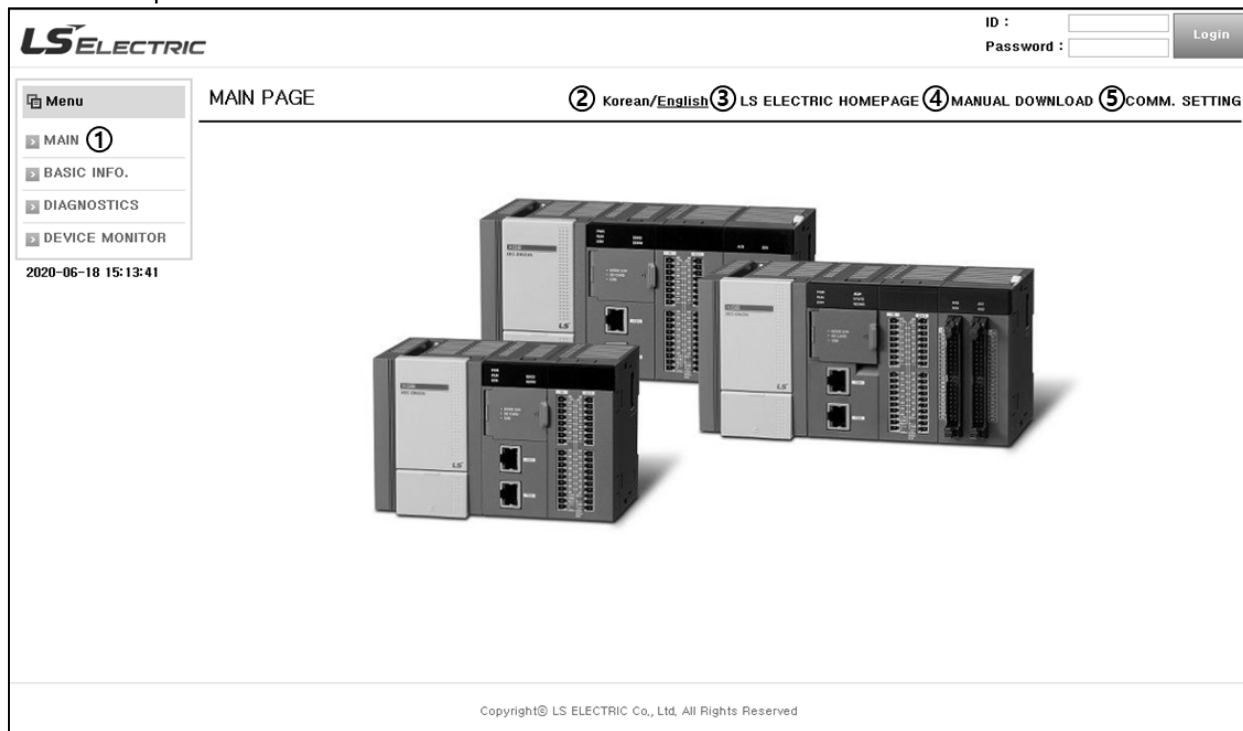

[Fig. 3.4.2.1] Main page

The main page provides the following functions.

No.	Name	Description
1	MAIN	Moving to the main page
2	Korean/English	Converting the language into Korean or English -Korean: Click this button to convert the English website into Korean. -English: Click this button to convert the Korean website into English.
3	LS ELECTRIC HOME PAGE	Moving to LS ELECTRIC's home page website
4	MANUAL DOWNLOAD	Moving to the manual download page of LS ELECTRIC's website
5	COMM. SETTING	Downloading the program that can change communication registry

1) Guidelines on communication setup

When you access to the web page for the first time, the pop-up window for communication setup will come on. The guide window for communication setup displays the messages so that a customer can check the communication setting functions provided to improve the web page's communication speed. If you do not want to see this message again, select the checkbox in the bottom-left of the screen and click the OK button. Then, the message window will not be created again.

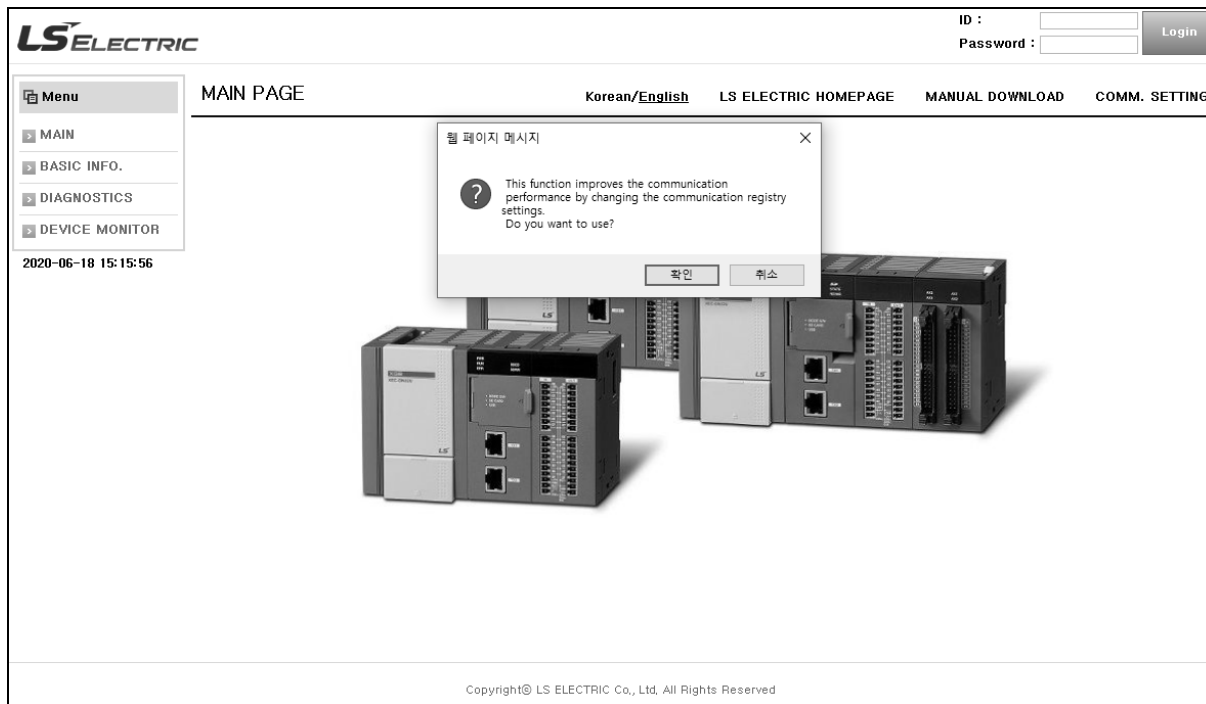

[Fig. 3.4.2.2] Pop-up window to guide communication setup

Notice

- (1) If you change the relevant PC's registry through communication setup functions, communication response speed increases and it will lead to improvement of the web server's communication speed.
- (2) If you select the checkbox 'Do not display this window any more' and click the OK button, the message window will not pop up again. However, when you access to the web page again after deleting the web browser's cookie, the message will come on again.

2) Communication Setup

- Communication response setting(TCP Ack. Frequency)

The web server adopted by XGB high-performance PLC module is supposed to send one data packet per one scan to minimize the impact on scan time. In this structure, if the response to the sent data packet is not immediately received, the next packet will not be sent until the response is received. However, in the case of Windows, when receiving data packets, generally, it is supposed to wait until 2 packets are received and send responses without responding to all packets or send the response in 200ms. Therefore, if you operate the web server in Windows without changing the registry, the communication speed will decrease. That is why the web server provides the program to change communication settings to solve such a problem.

- HTTP session number setting(HTTP Session Number Setting)

In Windows environment, it is possible to operate abnormally when the number of HTTP simultaneous connections is not a default number(6). For example, It is impossible to connect over 4 users when HTTP simultaneous connection numbers are more than 6. Therefore, if web server is operate abnormally when you connect 4-users simultaneously. Please use this function to solve such a problem.

When you execute a program after downloading the program as follows: 'TCP Ack. Frequency Setting' and 'HTTP Session Number Setting' box appears. Please use this function if you have a above-mentioned problems.

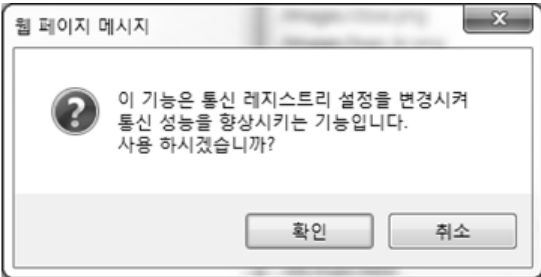
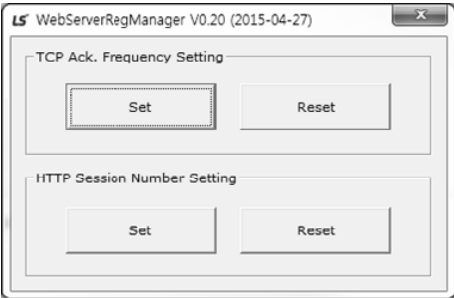
Procedure	Description	
1	File download	
<p>1) Click '[COMM. SETTING]' in the MAIN page. 2) If the web page's message pops up, click the OK button. 3) If you click the button, the TCPRegManager.zip file will be downloaded.</p>		
2	Program execution	
<p>1) If you unzip and execute the file after downloading the file, the program will be executed as shown above Web serverRegManager window. 2) Click the '[Set]' button in Web serverRegManager window.</p>		

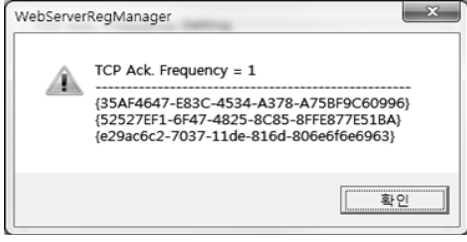
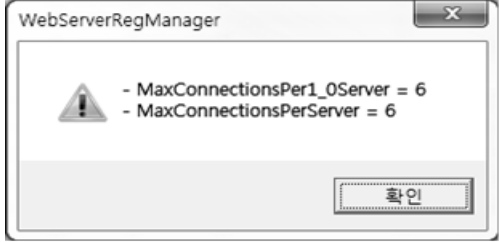
3	Registry Setting	
		
<p>1)If you click the '[Set]' button in the TCP ACK. Frequency Setting box, The TCP Ack Frequency registry will be set up.</p> <p>2)If you click the '[Set]' button in the HTTP Session number Setting box, The MaxConnctionsPer1_0Server and MaxConnectionsPerServer registry values are set by 6(default).</p> <p>3)If you click the '[OK]' button, setup will be completed.</p>		

Notice

- (1) If you click the '[Set]' or '[Reset]' button of the program, it will be disconnected from Ethernet to reread registry settings and be connected again.
- (2) If you want to restore the registry settings to the original state, click the '[Reset]' button.
- (3) if you change the registry setting, the web browser exit and re-start. And Use the Webserver after delete cookies and temporary files

3) Login

The web server provides a login function for restrictions on the use depending on authority.

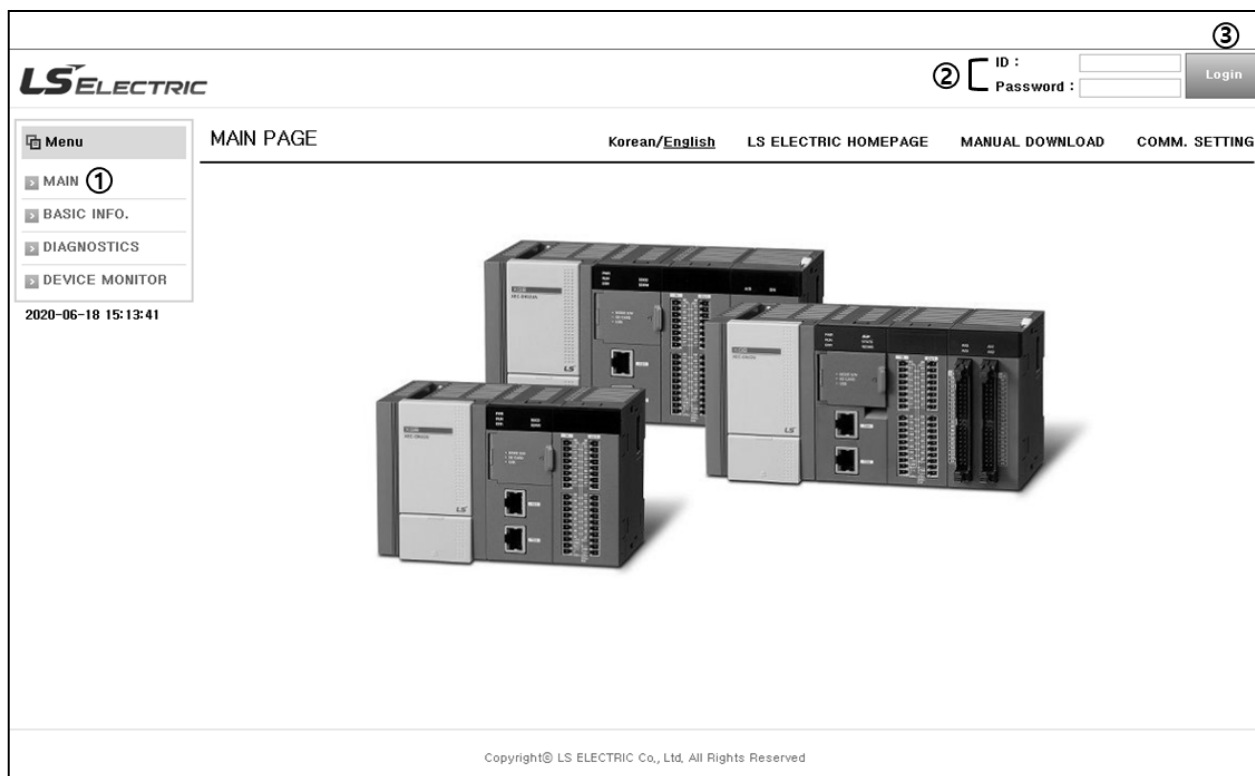

The below table shows you the details related to login to the web page.

No.	Name	Description
1	Main page	Moving to the main page
2	ID	Entering the account to login to the web server
	Password	Entering the password to login to the web server
3	Login	Login button

Notice

- (1) When logging into the web server for the first time, enter the ID and password set in XG5000 (administrator authorization).
- (2) If you want to register accounts, refer to 'Chap.3.4.8 Settings'.
- (3) When registering accounts, the available range may be different depending on authority permissions
- Refer to 3.4.1. 2) Limitations based on authority permissions

3.4.3 PLC Module basic information

You can monitor the PLC's information and change the PLC's operation mode in the BASIC INFO. page.

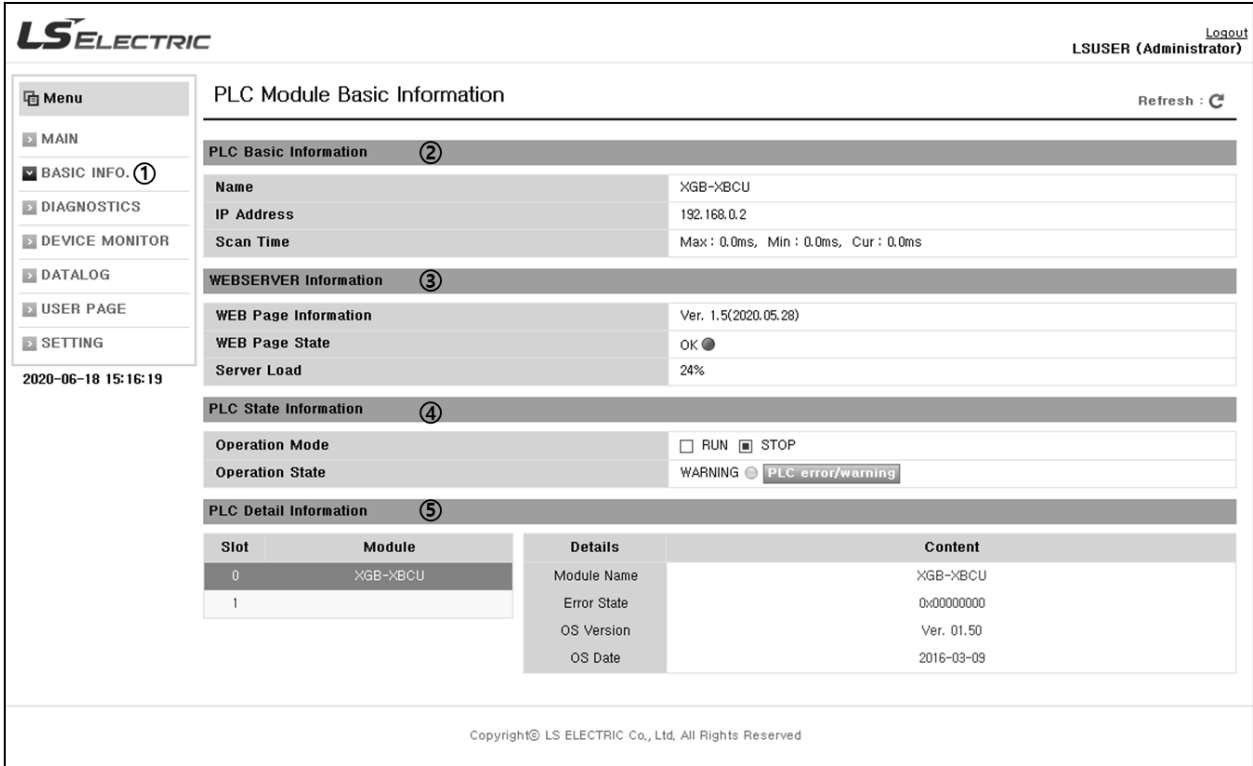

[Fig. 3.4.3.1] PLC Module Basic Information page

The below table shows you the details on the module's basic information.

No.	Name	Description
1	BASIC INFO.	Moving to PLC Module Basic Information page
2	PLC Basic Information	Displaying the PLC's name, IP address, scan time, server load information
3	WEB SERVER Information	Showing the web server's information
4	PLC State Information	Displaying the PLC's operation mode and operating conditions
5	PLC Detail Information	Displaying PLC's CPU and the expanded module's information

Notice

(1) You can change the PLC's operation mode only when you login with the administrator authorization.

1) PLC Basic Information

It is the function to monitor the PLC's name and IP address, scan time. Through the basic information, you can check the web server module's basic information.

2) WEB SERVER Information

It displays the version and creation date of the web page, state showing the type of the web page and web server module, server load indicating web server's service condition.

No.	Name	Description
1	WEB Page Information	Displaying the web page's version and creation date
2	WEB Page state	Comparing the PLC's CPU type with the web page type - OK: In case the web page type is the same as the server type. - ERROR : In case the web page type is different from the server type. (Namely, you need to match the web page type with the server type.)
3	Server Load	Displaying the web server's load - When a user accesses to the server, a load of about 24% is used.

3) PLC State Information

It is the function to monitor the PLC's operation mode and operating conditions. Namely, it provides the information on operation mode and operating conditions.



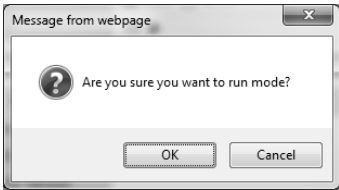
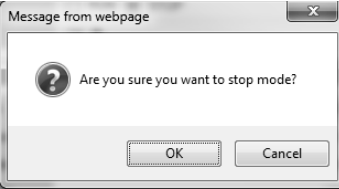

Operation mode

You can change the operation mode only when you login using the administrator account with authorization. If you click the RUN/STOP mode button, the message on mode conversion will pop up and when you click the OK button, it will be changed into the set operation mode.

Operation mode	Description	Remark
Click the RUN button		Switching the mode from STOP to RUN
Click the STOP button		Switching the mode from RUN to STOP

Operating conditions

Through operating conditions, you can check the operating conditions of the PLC that is currently connected. The information of each condition is displayed as below. If you click the message on each operating condition related to the occurrence time of warning/error mode such as WARNING, ERROR, you can check the detailed history.

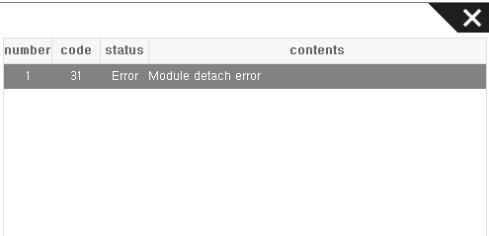
Operation mode	Description	Remarks
OK		PLC works normally.
WARNING	<p>- Operating conditions</p>  <p>- Detailed message on Error/Warning</p>  <p>Details and actions</p> <p>Warning: P2P parameter 4</p>	Minor failure such as wrong setting of P2P, HS , etc. occurs.
ERROR	<p>- Operating conditions</p>  <p>- Detailed message on Error/Warning</p>  <p>Details and actions</p> <p>Check if the module is installed correctly and reset the PLC, and then try again.</p>	Major failure such as module detachment occurs.

4) PLC Detail Information

Through the PLC's detailed information, a user who access to the web server can check the PLC's CPU and expended module's version information by slot.

3.4.4 Diagnosis information

The DIAGNOTICS page's provides the PLC's Diagnosis information obtained from the PLC module. In the diagnosis information, the composition of a page is as shown below and the details of each item are provided in the description on the diagnosis information.

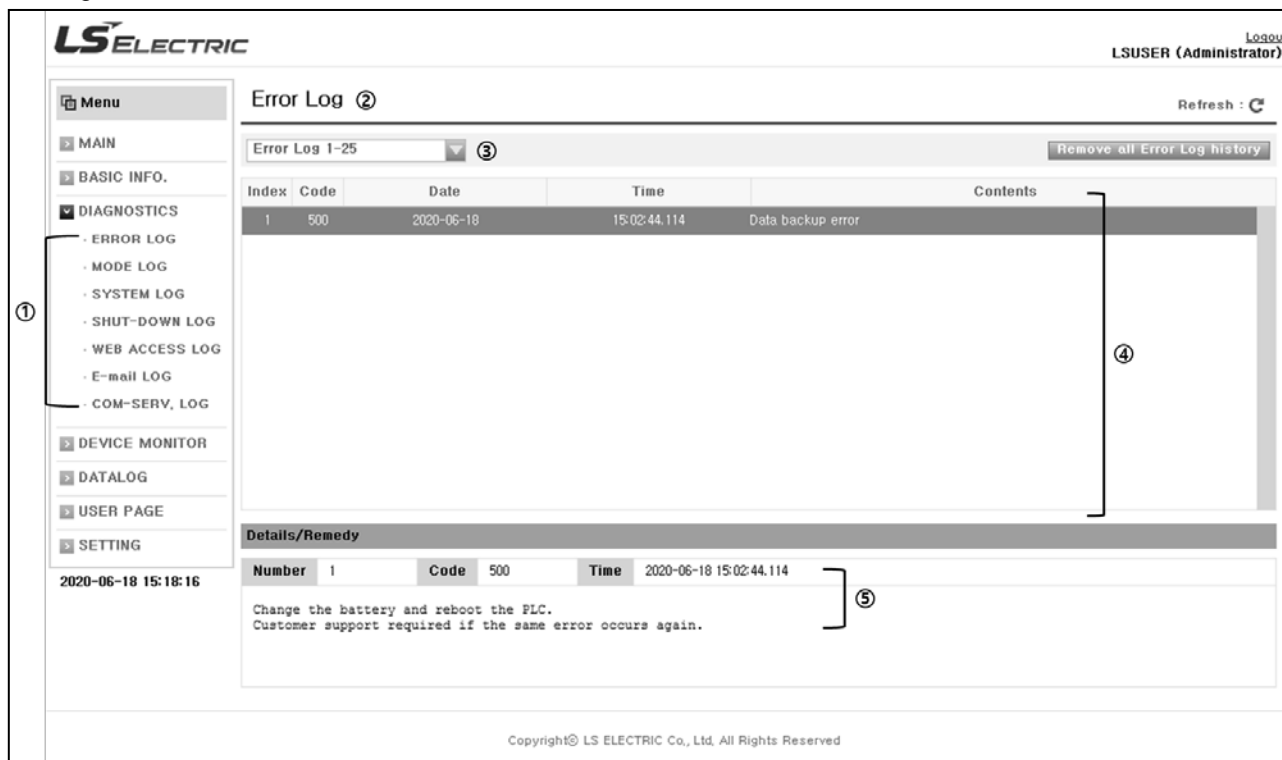

[Fig. 3.4.4.1] Composition of the diagnosis information (example of the Error Log)

[Table 3.4.4.1] Error log according to the diagnosis information

No.	Composition of a screen		Description	Remarks
1	Diagnosis information		It displays the history types provided by diagnosis information. If you click the desired history, it will move to the relevant page.	Refer to Table 3.4.4.2
2	Log Type	Error Log	It displays the name of the Log type chosen in the web page of diagnosis information.	
		Refresh	In case of new log, if you click Refresh, the log information will be updated.	
3	History	History No.	It means the log information No. provided by the PLC. The lower the number is, the more recently the history occurs.	Providing a maximum of 100 log information except E-mail history
		Remove all Log	The function is activated only when you access to the server with the administrator account. It deletes the log history saved in the PLC.	
4	Log details		It displays the details of the log chosen in the selection window of diagnosis information.	
5	Details/Remedy		The item is created only when you select the Error log in the selection web page. It provides the information on corrective measures each error.	

[Table 3.4.5-2] History information according to the diagnosis information

Diagnosis information	Description	Remarks ^[Note1]
Error Log	Providing the PLC's error log information	Up to 100 EA
Mode Log	Providing the information on operation mode conversion	Up to 100 EA
System Log	Providing the PLC's access log information	Up to 100 EA
Shut down Log	Providing the PLC's power shut down information	Up to 100 EA
Web access Log	Providing the web server module's access information	Up to 100 EA
E-mail Log	Providing the information on E-mail service history	Up to 25 EA
Communication service history (COM-SERV. LOG)	Providing the information on the embedded communication P2P service count	Up to 100 EA

1) ERROR LOG

It provides the Error history information of the PLC. The composition of a page is as shown below and the details of each item are provided in the description on the table.



[Table 3.4.5-2] Information of Error log page

No.	Name	Description	
1	Error Log 1-25	It is the checkbox to change the range of mode switching Log.No. One page is composed of 25EA. It provides the history information up to 100EA.	
2	History details	Index	It means error occurrence procedure. The lower the number is, the more recently the error log occurs.
		Code	It means the error code.
		Date	It means the date when the error occurs.
		Time	It means the time when the error occurs.
		Contents	It means the error details.
3	Details and Measures	If you click Error History, you can see the details and measures.	
4	Remove all Error Log History	The button is created when you access to the server with the administrator authorization. If you click this button and OK button, all error log histories will be deleted.	

2) MODE LOG

It provides the history information on the operation mode conversion such as the PLC's RUN or STOP, etc. The details of mode log are as shown below.

Index	Date	Time	Contents
1	2014/11/21	08:31:00.567	Remote, Run
2	2014/11/20	19:20:20.520	Web, Run
3	2014/11/20	18:07:38.274	Remote, Stop
4	2014/11/20	18:07:12.441	Remote, Stop
5	2014/11/20	18:06:49.444	Remote, Run
6	2014/11/20	16:23:26.317	Remote, Stop
7	2014/11/20	15:41:15.385	Remote, Stop
8	2014/11/20	15:14:23.600	Remote, Run

No.	Name	Description	
1	Mode Log 1-25	It is the checkbox to change the range of mode log history No. One page is composed of 25EA. It provides the history information up to 100EA.	
2	History details	Index	It means mode log history. The lower the number is, the more recently the mode conversion occurs.
		Code	It means the date when mode conversion occurs.
		Date	It means the time when mode conversion occurs.
		Time	It means the details of mode conversion.
3	Remove all Mode Log History	The button is created when you access to the server with the administrator authorization. If you click this button and OK button, all mode log histories will be deleted.	

Notice

[Note1] If the data exceeds the maximum number of histories provided by diagnosis information, the data will be deleted one by one starting with the past data.

Ex.) If 101st history appears after 100 error histories occurred, it will No.1 error history and the existing 100th history will be deleted.

3) SYSTEM LOG

It provides the system log information performed by XG5000 during running the PLC. The details of the system log are as shown below.

Index	Date	Time	Contents
1	2014/11/20	20:55:48.284	Momently shut-down
2	2014/11/20	20:55:36.728	REMOTE, OK, Disconnect
3	2014/11/20	20:50:01.739	REMOTE, OK, Connect
4	2014/11/20	18:51:32.858	REMOTE, OK, Disconnect
5	2014/11/20	18:50:18.404	REMOTE, OK, Connect
6	2014/11/20	18:50:12.976	No contents
7	2014/11/20	18:07:42.212	REMOTE, OK, Connect
8	2014/11/20	18:07:35.948	Momently shut-down

No.	Name	Description	
1	System Log 1-25	It is the checkbox to change the range of system log No. One page is composed of 25EA. It provides the history information up to 100EA.	
2	History details	Index	It means the system history. The lower the number is, the more recently system change history occurs.
		Data	It means the date when system change occurs.
		Time	It means the time when system change occurs.
		Contents	It means the details of system change.
3	Remove all System Log History	The button is created when you access to the server with the administrator authorization. If you click this button and OK button, all system log histories will be deleted.	

4) SHUT-DOWN LOG

It provides the shut-down histories to the PLC. The details of shut down history are as shown below.

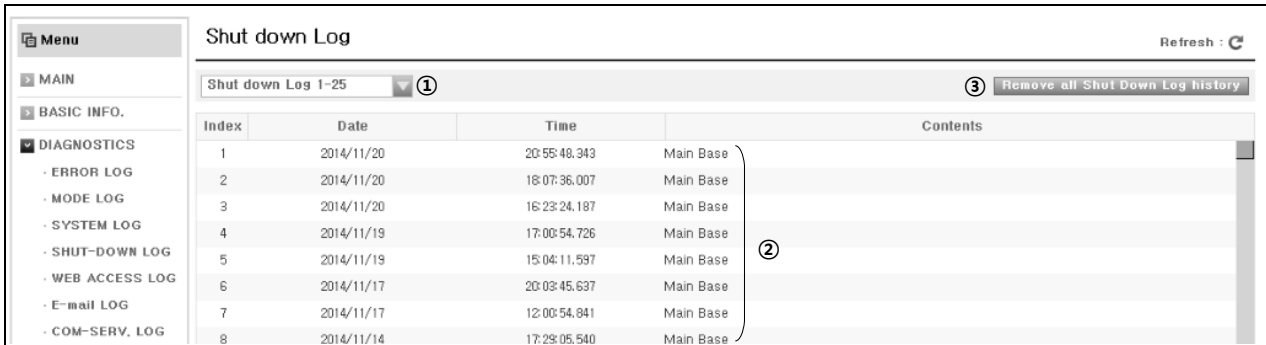

No.	Name	Details	
1	Shut down log 1-25	It is the checkbox to change the range of shut down log No. One page is composed of 25EA. It provides the history information up to 100EA.	
2	History details	Index	It means the power down history. The lower the number is, the more recently power down history occurs.
		Date	It means the date when power down occurs.
		Time	It means the time power down change occurs.
		Contents	It indicates the location where power down occurs.
3	Remove all System Shut Down History	The button is created when you access to the server with the administrator authorization. If you click this button and OK button, all shut-down histories will be deleted.	

5) WEB ACCESS LOG

It provides the history information that a user access to the web server. The details of web access history are as shown below.

Index	Date	Login time	Access IP	User Log
1	2014/11/21	08:43:16.434	165.244.149.29	LSIS(Administrator)
2	2014/11/21	08:42:51.916	165.244.149.29	GUEST(User)
3	2014/11/20	19:05:25.150	165.244.149.29	LSIS(Administrator)
4	2014/11/20	18:38:43.379	165.244.149.29	GUEST(User)
5	2014/11/20	18:22:32.835	165.244.149.29	GUEST(User)
6	2014/11/20	13:47:44.095	165.244.149.29	LSIS(Administrator)
7	2014/11/20	13:34:48.194	165.244.149.29	GUEST(User)
8	2014/11/20	13:34:35.863	165.244.149.29	GUEST(User)

No.	Name	Description	
1	Web access Log 1-25	It is the checkbox to change the range of web access history No. One page is composed of 25EA. It provides the history information up to 100EA.	
2	History details	Index	It means the web access history. The lower the number is, the more recently web access history occurs.
		Date	It means the date when web server access occurs.
		Login Time	It means the login time accessing to the web server.
		Access IP	It means the IP address of the user's computer accessing to the web server module.
	User Log	It means the account information of the user accessing to the web server module.	
3	Remove all Web Access Log History	The button is created when you access to the server with the administrator authorization. If you click this button and OK button, all web access histories will be deleted.	

6) E-mail LOG

Through E-mail transfer history, a user can check the history information that the web server has sent mails to the registered E-mail address. The details of E-mail transfer history are as shown below.

Menu		E-mail Log ①					Refresh :
<ul style="list-style-type: none"> MAIN BASIC INFO. DIAGNOSTICS <ul style="list-style-type: none"> ERROR LOG MODE LOG SYSTEM LOG SHUT-DOWN LOG WEB ACCESS LOG E-mail LOG COM-SERV. LOG 		E-mail Log 1-25 ③ Remove all E-mail Log history					
Index	Date	Time	E-mail Address	Title			
1	2014-11-20	19:38:35.040		Fail (Check SMTP Server)		②	
2	2014-11-20	18:38:41.881		Fail (Check SMTP Server)			
3	2014-11-20	17:06:08.859		Fail (Check SMTP Server)			
4	2014-11-20	17:06:07.679		Fail (Check SMTP Server)			
5	2014-11-20	17:06:05.289		Fail (Check SMTP Server)			
6	2014-11-20	17:05:19.231		Fail (Check SMTP Server)			
7	2014-11-20	16:38:54.278		Fail (Check SMTP Server)			
8	2014-11-20	16:38:47.797		Fail (Check SMTP Server)			

No.	Name	Description	
1	E-mail Log 1-25	It is the checkbox to change the range of e-mail history No. One page is composed of 25EA. It provides the history information up to 25EA.	
2	History details	Index	It means the number that completed E-mail service. The lower the number is, the more recently the E-mail is sent.
		Date	It means the date when E-mail transfer is completed.
		E-mail address	It means the E-mail address(recipient's mail address) sent from the PLC.
		Title	It indicates the transferred E-mail title.
		Fail	Fail (Check Network): SMTP Relay program is not connected to internet network or connection is not possible on a commercial E-mail server by a network security.
			Fail(Check SMTP Server): the ID or PW of the mail server is invalid.
3	Remove all E-mail Log History	The button is created when you access to the server with the administrator authorization. If you click this button and OK button, all E-mail histories will be deleted.	

Notice

In case of sending e-mail service based on Event information (RUN -> Stop, Stop -> Run, etc.),

Dialog

Use E-Mail
 Use SMTP relay server

User information

User name:
Mail address:

SMTP relay server information

IP address:
Port number:

SMTP server information

SMTP server address:
Port number:
Account name:
Password:

Event information

Message surveillance period: Sec.(10 ~)

	Address	Message
<input checked="" type="checkbox"/> RUN => STOP	0	1
<input checked="" type="checkbox"/> STOP => RUN	1	2
<input checked="" type="checkbox"/> ERROR	2	3

OK Cancel

when selecting [Write] in XG5000 for communication parameter setting, PLC goes to stop to activate it, which falls under Event information. In this special case, service history would be missing

7) Communication service history

It provides the information on service and error count of RS-232C, RS-485, FEnet P2P communication service among embedded communication functions of XGB high-performance PLC module. The details of communication service history are as shown below.

Menu		Communication Service Log		Refresh :
<ul style="list-style-type: none"> MAIN BASIC INFO. DIAGNOSTICS <ul style="list-style-type: none"> · ERROR LOG · MODE LOG · SYSTEM LOG · SHUT-DOWN LOG · WEB ACCESS LOG · E-mail LOG · COM-SERV. LOG DEVICE MONITOR 				
RS-232				
Service Count		Error		
6872		6872		
RS-485				
Service Count		Error		
6874		6874		
FEnet				
Service Count		Error		
5068		57		

No.	Name		Description
1	Service count	RS-232	Information on the whole service count of RS-232C channel among embedded communications
		RS-485	Information on the whole service count of RS-485 channel among embedded communications
		FEnet	Information on the whole service count of FEnet's P2P channel among embedded communications
2	Error	RS-232	Information on the whole error count of RS-232C channel among embedded communications
		RS-485	Information on the whole error count of RS-485 channel among embedded communications
		FEnet	Information on the whole error count of FEnet's P2P channel among embedded communications

Notice

- (1) When you connect to the web server in a web browser for the first time : The history will be saved as GUEST.
- (2) When you succeed in login: The relevant login account history will be saved.
- (3) If the web browser does not exchange data with the web server for a certain time, connection will end.
(After that, if you connect to the web server again, it will be the same as the case of (1).)

3.4.5 Device Monitor

It means the function to monitor or change the value of the device selected by a user through accessing to the web server. If you login with the administrator or general accounts, you can change the selected device's value, however, if you login with the guest account, the available function is monitoring only.

Device monitoring can be largely divided into device monitoring and flag monitoring.

1) Available device area

(1) XBC series PLC(MK type)

Area	Start		End		Remarks
	Word	Bit	Word	Bit	
P	P0000	P00000	P2047	P2047F	Read, Write Enable
M	M0000	M00000	M2047	M2047F	Read, Write Enable
K	K0000	K00000	K8191	K8191F	Read, Write Enable
F	F0000	F00000	F2047	F2047F	Read Enable
T	T0000	T0000	T2047	T2047	Read, Write Enable
C	C0000	C0000	C2047	C2047	Read, Write Enable
U	U00.00	U00.00.0	U0B.31	U0B.31.F	Read, Write Enable
S	-	S000.00	-	S127.99	Read, Write Enable
Z	Z000	-	Z127	-	Read, Write Enable
L	L0000	L00000	L4095	L4095F	Read, Write Enable
N	N00000	-	N10239	-	Read Enable
D	D00000	D00000.0	D19999	D19999.F	Read, Write Enable
R	R00000	R00000.0	R16383	R16383.F	Read, Write Enable
ZR	ZR00000	-	ZR32767	-	Read, Write Enable

(2) XEC series PLC(IEC type)

Area	Type	Start	End	Remarks
I	Bit	%IX0.0.0	%IX15.15.63	Read, Write Enable
	Byte	%IB0.0.0	%IB15.15.7	Read, Write Enable
	Word	%IW0.0.0	%IW15.15.3	Read, Write Enable
	Dword	%ID0.0.0	%ID15.15.1	Read, Write Enable
	Lword	%IL0.0.0	%IL15.15.0	Read, Write Enable
Q	Bit	%QX0.0.0	%QX15.15.63	Read, Write Enable
	Byte	%QB0.0.0	%QB15.15.7	Read, Write Enable
	Word	%QW0.0.0	%QW15.15.3	Read, Write Enable
	Dword	%QD0.0.0	%QD15.15.1	Read, Write Enable
	Lword	%QL0.0.0	%QL15.15.0	Read, Write Enable
M	Bit	%MX0	%MX262143	Read, Write Enable
	Byte	%MB0	%MB32767	Read, Write Enable
	Word	%MW0	%MW16383	Read, Write Enable
	Dword	%MD0	%MD8191	Read, Write Enable
	Lword	%ML0	%ML4095	Read, Write Enable

Chapter 3 Web Server

Area	Type	Start	End	Remarks
L	Bit	%LX0	%LX65535	Read, Write Enable
	Byte	%LB0	%LB8191	Read, Write Enable
	Word	%LW0	%LW4095	Read, Write Enable
	Dword	%LD0	%LD2047	Read, Write Enable
	Lword	%LL0	%LL1023	Read, Write Enable
N	Bit	%NX0	%NX163839	Read Enable
	Byte	%NB0	%NB20479	Read Enable
	Word	%NW0	%NW10239	Read Enable
	Dword	%ND0	%ND5119	Read Enable
	Lword	%NL0	%NL2559	Read Enable
K	Bit	%KX0	%KX131071	Read, Write Enable
	Byte	%KB0	%KB16383	Read, Write Enable
	Word	%KW0	%KW8191	Read, Write Enable
	Dword	%KD0	%KD4095	Read, Write Enable
	Lword	%KL0	%KL2047	Read, Write Enable
U	Bit	%UX0.0.0	%UX0.11.511	Read, Write Enable
	Byte	%UB0.0.0	%UB0.11.63	Read, Write Enable
	Word	%UW0.0.0	%UW0.11.31	Read, Write Enable
	Dword	%UD0.0.0	%UD0.11.15	Read, Write Enable
	Lword	%UL0.0.0	%UL0.11.7	Read, Write Enable
R	Bit	%RX0	%RX262143	Read, Write Enable
	Byte	%RB0	%RB32767	Read, Write Enable
	Word	%RW0	%RW16383	Read, Write Enable
	Dword	%RD0	%RD8191	Read, Write Enable
	Lword	%RL0	%RL4095	Read, Write Enable
A	Bit	%AX0	%AX524287	Read Enable
	Byte	%AB0	%AB65535	Read Enable
	Word	%AW0	%AW32767	Read Enable
	Dword	%AD0	%AD16383	Read Enable
	Lword	%AL0	%AL8191	Read Enable
W	Bit	%WX0	%WX524287	Read Enable
	Byte	%WB0	%WB65535	Read, Write Enable
	Word	%WW0	%WW32767	Read, Write Enable
	Dword	%WD0	%WD16383	Read, Write Enable
	Lword	%WL0	%WL8191	Read, Write Enable
F	Bit	%FX0	%FX32767	Read Enable
	Byte	%FB0	%FB4095	Read Enable
	Word	%FW0	%FW2047	Read Enable
	Dword	%FD0	%FD1023	Read Enable
	Lword	%FL0	%FL511	Read Enable

(3) Data type

No.	Type		Size (bit)	Meaning	Range
	Reserved word	Data type			
0	SINT	Short Integer	8	Signed decimal number	-128 ~127
1	INT	Integer	16	Signed decimal number	-32768 ~32767
2	DINT	Double Integer	32	Signed decimal number	-2147483648 ~ 2147483647
3	LINT	Long Integer	64	Signed decimal number	-9223372036854775808 ~ 9223372036854775807
4	USINT	Unsigned Short Integer	8	Unsigned decimal number	0 ~ 255
5	UINT	Unsigned Integer	16	Unsigned decimal number	0 ~ 65535
6	UDINT	Unsigned Double Integer	32	Unsigned decimal number	0 ~ 4294967295
7	ULINT	Unsigned Long Integer	64	Unsigned decimal number	0 ~ 18446744073709551615
8	REAL	Real Numbers	32	Signed decimal number	-3.402823466e+038 ~ -1.175494351e-038 or 0 or 1.175494351e-038 ~ 3.402823466e+038 (0 -> 0.000000000e+000)
9	LREAL	Long Real Numbers	64	Signed decimal number	-1.7976931348623157e+308 ~ -2.2250738585072014e-308 or 0 or 2.2250738585072014e-308 ~ 1.7976931348623157e+308 (0 -> 0.0000000000000000e+000)
10	TIME	Duration	32	Clock data	T#00D00H00M00S000MS ~ T#49D17H02M47S295MS
11	DATE	Date	16	Clock data	D#1984-01-01 ~ D#2163-06-06
12	TIME_OF_DAY	Time Of Day	32	Clock data	TOD#00:00:00.000 ~ TOD#23:59:59.999
13	DATE_AND_TIME	Date And Time Of Day	64	Clock data	DT#1984-01-01-00:00:00.000 ~ DT#2163-12-31-23:59:59.999
14	STRING	Character String	32*8	TEXT	'abcd GaNaDaRa 1234' (Korean 15 characters, Numbers + English 31 characters)

Chapter 3 Web Server

No.	Type	Data type	Size (bit)	Meaning	Range
	Reserved word				
15	BOOL	Boolean	1	Unsigned decimal number	1,0(On, Off)
16	BYTE	Bit String of Length 8	8	Hexadecimal number	h00 ~ hFF[16#00 ~ 16#FF]
17	WORD	Bit String of Length 16	16	Hexadecimal number	h0000 ~ hFFFF[16#0000 ~ 16#FFFF]
18	DWORD	Bit String of Length 32	32	Hexadecimal number	h00000000 ~ hFFFFFFFF [16#00000000 ~ 16#FFFFFFFF]
19	LWORD	Bit String of Length 64	64	Hexadecimal number	h0000000000000000 ~ hFFFFFFFFFFFFFFFF [16#0000000000000000 ~ 16#FFFFFFFFFFFFFFFF]

2) Device Monitoring

In the device monitoring page, you can register and change the targeted PLC devices. The functions can be largely divided into individual monitoring and integrated monitoring. In the device monitoring menu of the web page, if you click 'Device Monitoring', the screen will be moved to the relevant page. The composition of device monitoring page is as shown below.



No.	Screen configuration		Description	Remarks
1	Selection of monitoring type	Individual monitoring	Page where you can register devices by login account and monitor them.	A maximum of 10 devices can be registered and edited.
		Integrated monitoring	Page where you can register devices commonly for all login accounts and monitor them. If the device value is registered in advance, it can be monitored without separate login.	
2	Edition of device	Add	To add devices	
		Edit	To edit devices	
		Modify value	To change device values	
		Delete	To delete devices	
3	Update cycle setting		Selecting the update cycle of device monitoring	cycle: N/A, 10 seconds, 20 seconds, 30 seconds, 1 minute
4	Device monitoring	Index	The number is allocated in the order of registering devices.	Input range of comment -Korean: 14 haracters -English, number:28 characters
		Device	Device name, type, view format registered by a user through additional functions are displayed.	
		Type		
		Display format		
		Value	It means the current value of the device added by a user.	
		Comment	It is the comment of the device added by a user.	

Chapter 3 Web Server

(1) Registration of devices

For device monitoring, you need to register devices. The below table shows you how to register devices. The method how to add devices is the same in both individual monitoring and integrated monitoring.

Procedures	Description								
1	Click [DEVICE MONITOR] → [DEVICE] in the web page to move to the device monitoring page.								
2	When monitoring the device value in login account only, select [Individual Monitoring]; When the whole users monitor the device commonly, select [Integrated Monitoring].								
3	<div style="display: flex; align-items: center;"> <div style="flex: 1; text-align: center; vertical-align: middle;">Add Device</div> <div style="flex: 2; border: 1px solid black; padding: 5px; margin-left: 10px;"> <div style="border: 1px solid gray; padding: 5px; margin-bottom: 5px;"> ① ✕ <div style="display: flex; justify-content: space-between; margin-bottom: 5px;"> Add Edit Modify value Delete </div> <table style="width: 100%; border-collapse: collapse;"> <tr> <td style="width: 30%;">Type</td> <td>SINT</td> </tr> <tr> <td>Display format</td> <td>Signed decimal</td> </tr> <tr> <td>Device</td> <td><input type="text"/></td> </tr> <tr> <td>Comment</td> <td><input type="text"/></td> </tr> </table> <div style="text-align: right; margin-top: 5px;"> Add Cancel </div> </div> </div> <div style="flex: 1;"> <p>Click [Add] in the window for added devices.</p> <p>If the device input window is created, select and input the proper type and display format for the targeted device. Each meaning is as shown below.</p> <p>For more details, refer to 'Chap.3.4.5 2) Device Monitor</p> <p>Type: Selecting the device type</p> <p>Display format: Selecting the device's display format</p> <p>Device: Inputting the device for each language(MK/IEC)</p> <p>Comment: Inputting the comment for the device value</p> <p>If you click the [Add] button, you can see the set device value will be registered in the monitoring window.</p> <p>If you click the [Cancel] button, the window for device input will be canceled.</p> </div> </div>	Type	SINT	Display format	Signed decimal	Device	<input type="text"/>	Comment	<input type="text"/>
Type	SINT								
Display format	Signed decimal								
Device	<input type="text"/>								
Comment	<input type="text"/>								

(2) Edition of devices

It is the function to edit the registered devices as shown below.

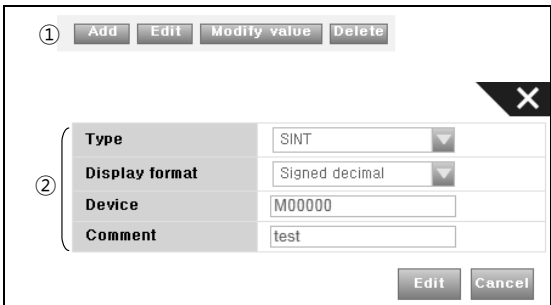
Procedures	Description	
1	Select the device to edit.	
2	Edit device	 <p>Click [Edit] in the window for editing devices. If the device edition window is created, select and input the proper type and display format for the targeted device. Each meaning is as shown below. For more details, refer to 'Chap.3.4.5 2) Device Monitoring.' If you the [Edit] button, you can see the device value will be changed into the set one in the monitoring window. If you clicik the [Cancel] button, the device edition window will be canceled.</p>

(3) Change of device values

It is the function to change the value of the registered device as shown below.

Procedures	Description	
1	Select the device to change.	
2	Change device value	 <p>Click [Modify Value] in the device edition window. If the device edition window is created, input the value to change. If you the [Edit] button, you can see the device value will be changed into the set one in the monitoring window. If you clicik the [Cancel] button, the window for device change will be canceled.</p>

Chapter 3 Web Server

(4) Deletion of device values

It is the function to delete the registered devices as shown below.

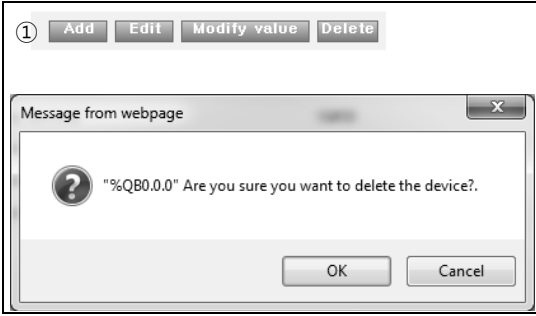
Procedures	Description	
1	Select the device to delete.	
2	Delete Device	 <p>Click [Delete] in the device edition window. The webpage message asking whether deleting the selected device from the monitoring page is created. If you click the [OK] button, the relevant device will be deleted. If you the [Cancel] button, the webpage message will disappear and the device will not be deleted.</p>

3) Flag Monitoring

In the flag monitoring page, you can register and change the PLC flags to monitor. The function can be largely divided into individual monitoring and integrated monitoring. In the device monitoring menu of the web page, if you click 'Flag Monitoring', the screen will be moved to the relevant page. The screen configuration and meaning of the flag monitoring are as shown below.

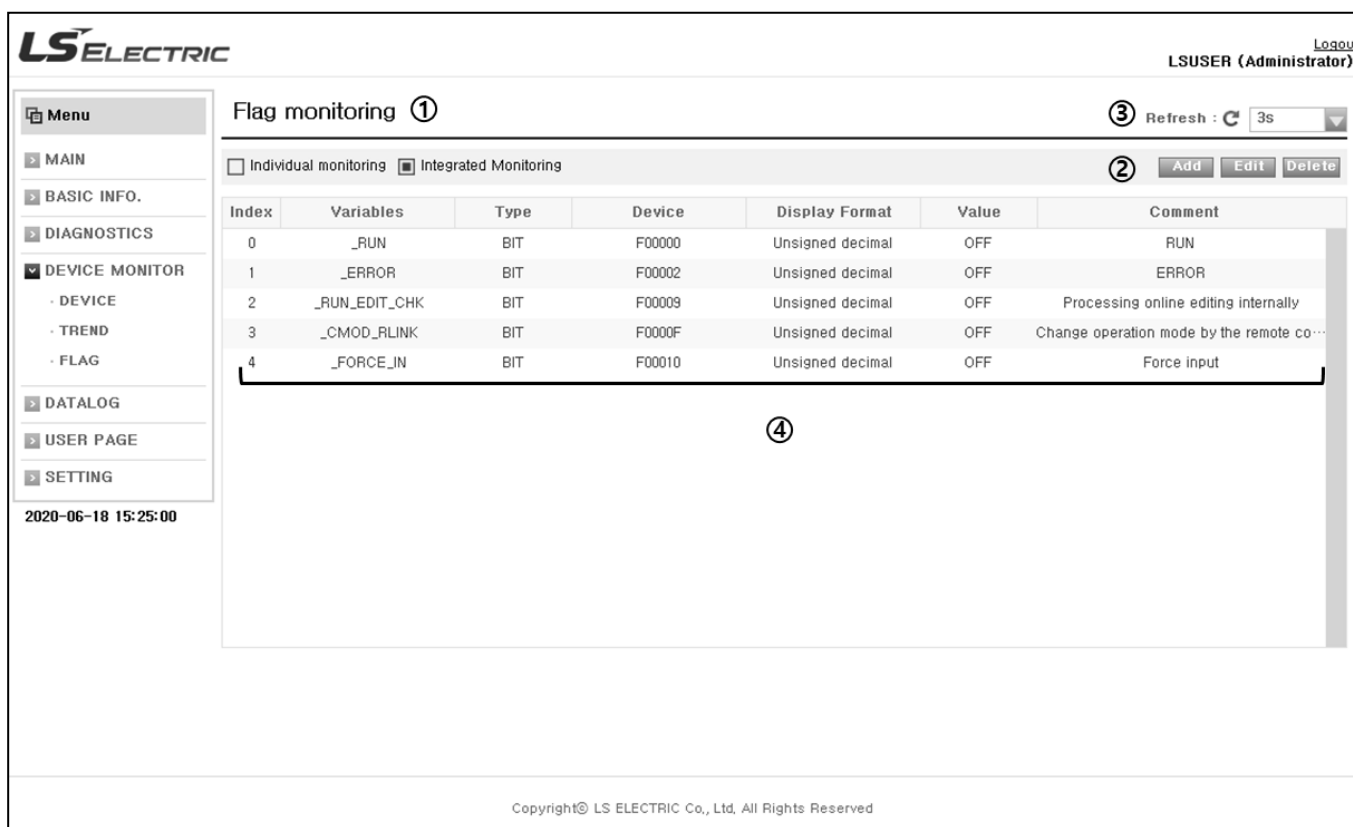

No.	Screen configuration		Description	Remarks
1	Selection of monitoring type	Individual monitoring	Page where you can register flags by login account and monitor them.	A maximum of 10 devices can be registered and edited.
		Integrated monitoring	Page where you can register flags commonly for all login accounts and monitor them. If the device value is registered in advance, it can be monitored without separate login.	
2	Edition of flag	Add	To add devices	
		Edit	To edit devices	
		Delete	To change device values	
3	Update cycle setting		Selecting the update cycle of device monitoring	cycle: N/A, 10 seconds, 20 seconds, 30 seconds, 1 minute
4	Flag monitoring	Index	The number is allocated in the order of registering flags.	Changing flag values is available for WORD or DWORD type only
		Device	Flag's name	
		Type	Flag type	
		Display format	Flag's device	
		Value	Flag's format	
		Comment	Flag's value	
		Index	Flag's meaning	

Chapter 3 Web Server

(1) Addition of system flags

For system flag monitoring, you need to add flags as shown below.

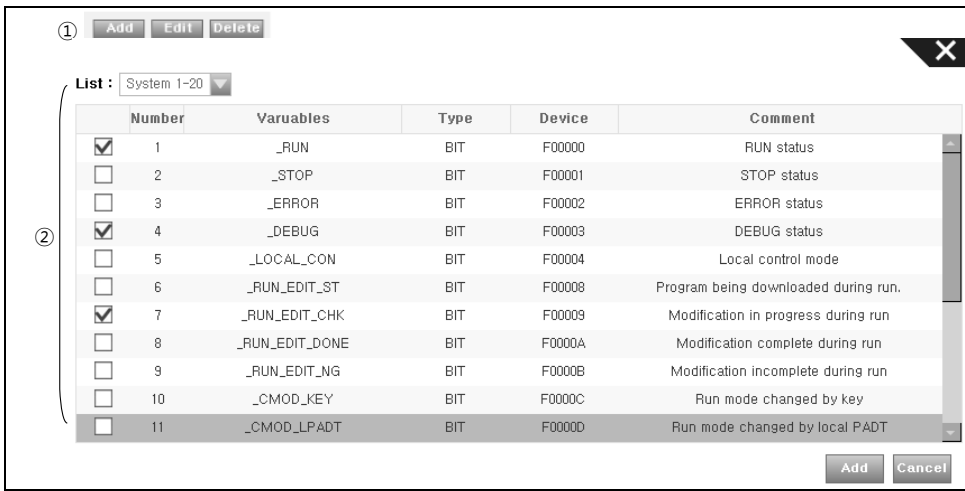
Procedures	Description
1	Click [DEVICE MONITOR] → [FLAG] in the web page to move to the flag monitoring page.
2	When monitoring the flag value in login account only, select [Individual Monitoring]; When the whole users monitor the flag value commonly, select [Integrated Monitoring].
3	<div style="display: flex; align-items: center;"> <div style="flex: 1; text-align: center; vertical-align: middle;">Add flag</div> <div style="flex: 2;">  </div> </div> <p>Click [Add] in the flag edition window. If the flag selection window is created, select the system flag to monitor. Select the flag to monitor by clicking the system No. of the list. If you click the [Add] button, you can see the selected flag value will be registered in the monitoring window. If you click the [Cancel] button, flag addition window will be canceled.</p>

(2) Edition of system flags

If the system flag type is WORD or DWORD, through this function, you can convert the view format into hexadecimal number or signed decimal number, unsigned decimal number as shown below.

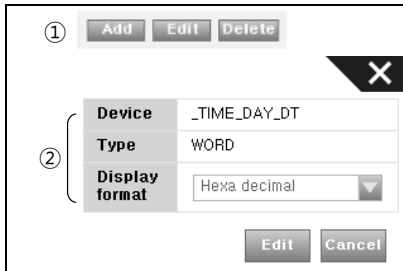
Procedures	Description
1	Select the flag to edit.
2	<div style="display: flex; align-items: center;"> <div style="flex: 1; text-align: center; vertical-align: middle;">Edit flag</div> <div style="flex: 2;">  </div> </div> <ol style="list-style-type: none"> 1) Click [Edit] in the flag edition window. 2) If the flag edition window is created, change the display format into the desired format. 3) If you click the [Edit] button, you can see the flag value is monitored in the changed format. 4) If you click the [Cancel] button, the flag edition window will be canceled.

(3) Deletion of system flags

It is the function to delete the system flags registered in the system flag monitoring list as shown below.

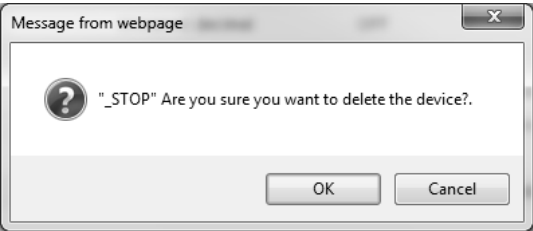
Procedures	Description	
1	Select the falt to delete.	
2	Delete flag	<div style="text-align: center;">  </div> <div style="text-align: center;">  </div> <p>Click [Delete] in the flag edition window. The webpage message asking whether deleting the selected flag from the monitoring page is created. If you click the [OK] button, the relevant device will be deleted. If you the [Cancel] button, the webpage meassage will disappear and the device will not be deleted.</p>

Notice

(1) For the information on flags, refer to Appendix 1. Flag List.

3.4.6 Data log

The web server provides the function for data log file download. It is the function to download the data log(*.CSV) file created by the data log function through the web server remotely. The screen configuration and meaning of data log file page are as shown below.

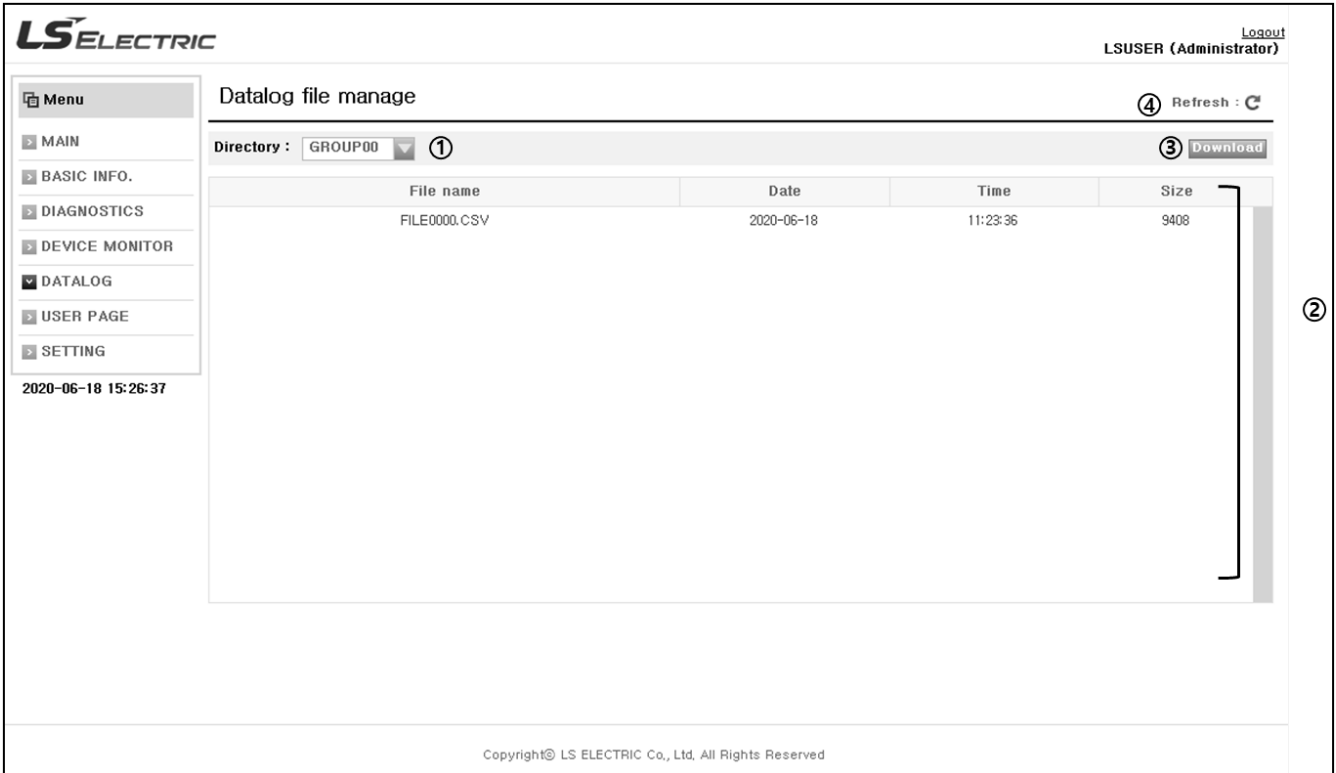

No.	Screen configuration	Description	Remarks
1	Directory	It is the checkbox to select the data log directory saved in the SD card.	
2	File list	Displaying the information on the data log	
3	File download	Downloading the data log file from the PLC	Available only for individual download
4	Refresh	If you click the 'Refresh' button, the window will be updated into the final screen.	

1) File download

You can download the log file created by the data log function as shown below.

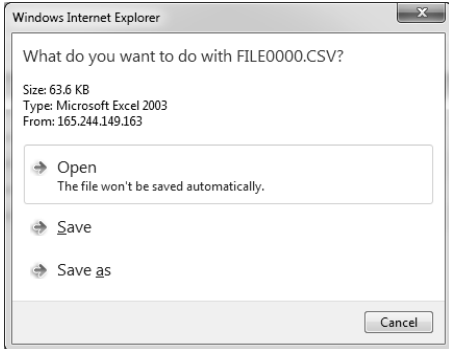
Procedures	Description	
1	Select the data log file to download.	
2	Click the 'Download' button.	
2	File download	
	<p>Click the '[Download]' button. Select 'Save' or 'Save as' to download the file. - If you click the 'Open' button, the file will not be saved automatically.</p>	

3.4.7 User page

Through the user page, a user can monitor and control the PLC by making the web page personally. A user can make the web page with making tools. The user page provides very convenient environment for a user since the user can monitor and control the PLC remotely without installing other devices.

For registering the webpage made by a user, refer to 3.4.8 Settings.



The screen configuration and details of the user page are as shown below. You can access to the user page by clicking the user page button or by inputting the user page's URL directly.

No.	Screen configuration	Description	Remarks
1	User page	Moving to the user page	
2	User page screen	User page under the state that the webpage made by a user is not registered	The user page can be registered only when you login with the administrator account

1) How to access to the user page in the basic web page

You can access to the user page in the basic web page as shown below.

- (1) Click '[USER PAGE]' in the screen configuration.
- (2) Then, the screen will be moved to the user page made by a user.

2) How to access to the user page by inputting the URL

To connect to the user page directly, you need to input the URL to the web page address bar as shown below.

(1) Input 'http://XXX.XXX.XXX.XXX/UserPage/home.html' in the URL input area of the web page.

-'xxx.xxx.xxx.xxx' means the web server's IP address.

(2) Then, the screen will be moved to the user page.

Notice

- (1) For making the user web page, refer to 'Appendix 4 How to make the user page'.
- (2) To send the user web page to the web server, refer to '3.4.8 Settings'.
- (3) For setting the web server's IP address, refer to '3.3.1 TCP/IP Setting'.
- (4) When making the user page, the initial loading page file's name should be 'home.html'.

3.4.8 Setting

It provides the functions related to user account setting for login to the web server, IP filtering setting, PLC's Time setting, user page setting. In terms of the authority for setting items, you can set up and change them only when you login with the administrator account. The screen configuration and details are as shown below.



Screen configuration	Description	Remarks
USER ACCOUNT	Function to add, edit or delete accounts to login to the web server	
IP FILTERING	Setting blocking and permission of specific IPs for security of the web server	
TIME	Function to set the PLC's time by accessing to the web server	
USER PAGE	Function to transfer the web page files made by a user to the web server or manage files of the web server	

1) User account setting

It is the function to add, edit or delete accounts to login to the web server.

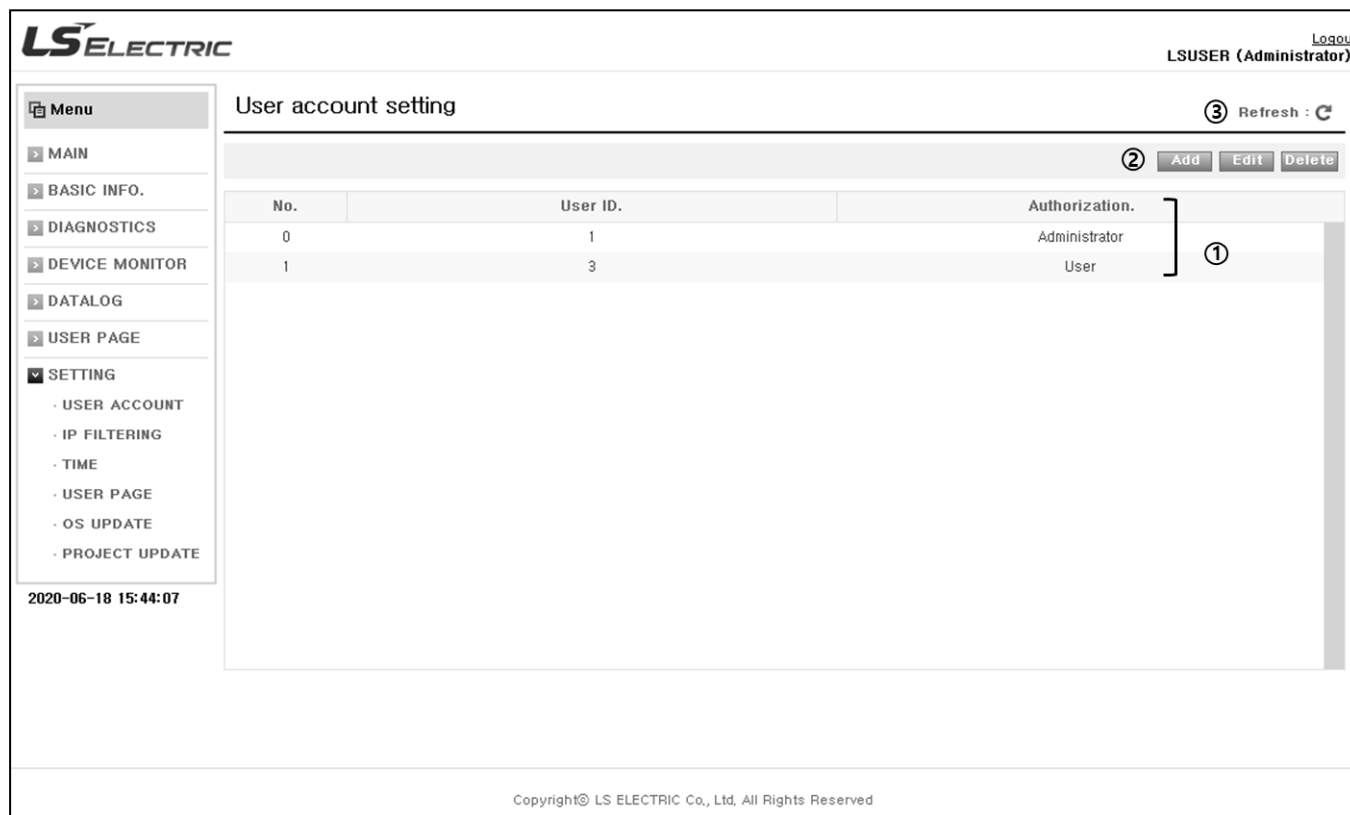



The screen configuration and details are as shown below.

No.	Screen configuration	Description	Remarks
1	User account setting screen	No.	Registration order of user accounts
		User ID	ID of the account assigned by the administrator
		Authorization	Authorization of each account
2	Account edition	Add	To add the user account
		Edit	To edit the user account
		Delete	To delete the user account
3	Refresh	If you click the 'Refresh' button, the window will be updated into the final screen.	

Chapter 3 Web Server

(1) Addition of user accounts

It is the function to register accounts additionally to login to the web server as shown below.

Procedures	Description									
1	Click [SETTING] → [USER ACCOUNT] in the webpage to move to the user account setting page.									
2	<div style="display: flex; align-items: center;"> <div style="width: 150px; text-align: center; vertical-align: middle;">Add accounts</div> <div style="flex-grow: 1;">  </div> </div> <p>Click [Add] in the account edition window. When the window for adding user accounts is created, input the targeted account information. ID : Enter the account's ID. password : Enter the account's password Authorization : Select the account's authorization (General, administrator) If you click the [Add] button, the input account will be displayed in the user account setting screen. If you click the [Cancel] button, the window for adding user accounts will be canceled and the account will not be added.</p>									
3	<div style="display: flex; align-items: center;"> <div style="width: 150px; text-align: center; vertical-align: middle;">Adding accounts is done</div> <div style="flex-grow: 1;">  <table border="1" style="width: 100%; margin-top: 10px;"> <thead> <tr> <th>No.</th> <th>User ID.</th> <th>Authorization.</th> </tr> </thead> <tbody> <tr> <td>0</td> <td>test</td> <td>User</td> </tr> <tr> <td>1</td> <td>test2</td> <td>Administrator</td> </tr> </tbody> </table> </div> </div> <p>If you click the [Add] button in the above 2, the window indicating registration is done will pop up. If you click the 'OK' button, you can see the account is added to the user account setting screen.</p>	No.	User ID.	Authorization.	0	test	User	1	test2	Administrator
No.	User ID.	Authorization.								
0	test	User								
1	test2	Administrator								

Notice

- (1) The authority for registering accounts can be divided into the administrator authorization and general authorization.
 - For more details on use by authorization, refer to '3.4.1 2) Limitations based on authority permissions'.
- (2) You can register the login account up to 15 people.
- (3) When you login to the web server for the first time, you cannot delete or edit the account registered in XG5000 on the web page.

(2) Edition of user account

It is the function to edit the user information registered in the user account list as shown below.

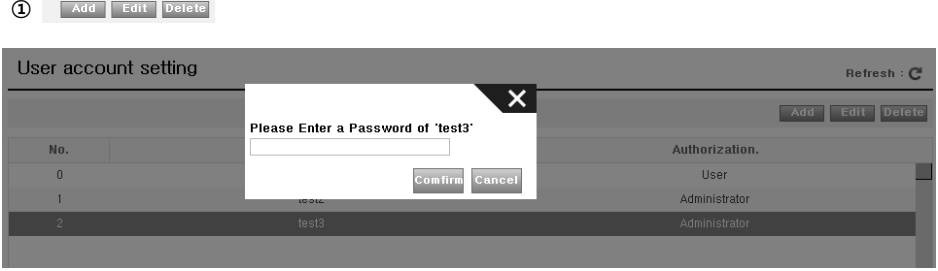
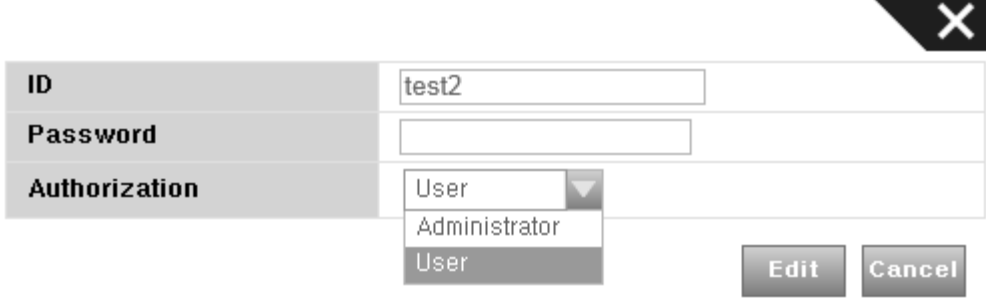
Procedures	Description	
1	Click [SETTING] → [USER ACCOUNT] in the webpage to move to the user account setting page. Select the account to edit.	
2	Password input	
	<p>Click [Edit] in the account edition window. After entering the password of the account to edit, click the OK button. - If you access to the web server account set in the TCP/IP setting window of the embedded FEnet, you do not need to check the password separately.</p>	
3	Edit account	
	After changing the ID, password, access authorization, if you click the OK button, edition will be done.	

Chapter 3 Web Server

(3) Deletion of user accounts

It is the function to delete users registered in the user account list as shown below.

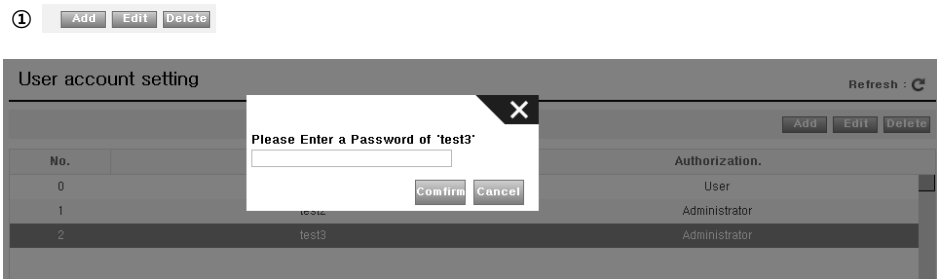
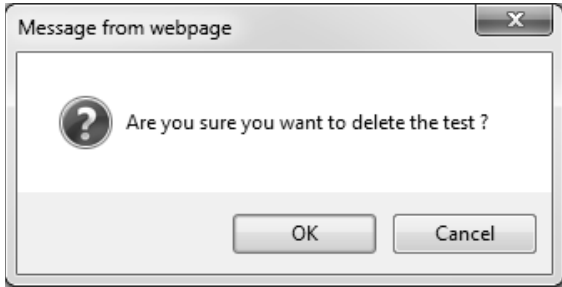
Procedures	Description	
1	Click [SETTING] → [USER ACCOUNT] in the webpage to move to the user account setting page. Select the account to delete.	
2	Password input	 <p>Click [Delete] in the account edition window. After entering the password of the account to delete, click the OK button. If you access to the web server account set in the TCP/IP setting window of the embedded FEnet, you do not need to check the password separately. If the authorization of the account to delete is general one, you do not need to check the password separately.</p>
3	Delete accounts	 <p>If you click the OK button, the targeted account will be deleted.</p>

Notice

- (1) If you edit or delete the administrator account, the message asking the password of the selected account will pop up.
- (2) In the case of the account registered in XG5000, if you delete or edit other accounts with the master account, the message asking the password will not pop up.

2) IP filtering setting

The function for IP filtering setting that focuses on the web server's security can be divided into IP blocking, IP permission, Disable The screen configuration and meaning of the IP filtering setting are as shown below.





No.	Screen configuration	Description	Remarks
1	IP filtering setting screen	Number	Registration order of IP filtering setting
		Start address	Start address of IP where filtering is set up
		End address	End address of IP where filtering is set up
2	IP filtering menu	IP blocked	Activating the function to block off the input IP Up to 15EA
		IP allowed	Activating the function to allow the input IP only Up to 15EA
		Not use	The IP filtering function is not in use
3	IP edition menu	Add	To add the IP address
		Edit	To edit the IP address
		Delete	To delete the IP address
4	Refresh	If you click the 'Refresh' button, the window will be updated into the final screen.	

Chapter 3 Web Server



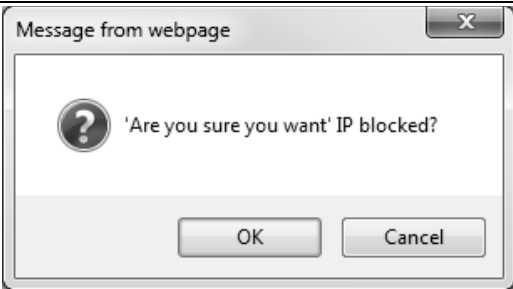

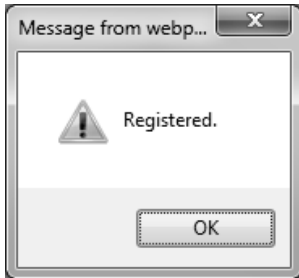
(1) Addition of IP blocking

IP blocking is the function to block off unwanted IP's access to the web server by registering IPs as shown below.

Procedures	Description
1	<p>Click [SETTING] → [IP FILTERING] in the webpage to move to the IP filtering setting page.</p> <p>IP blocked</p>  <p><Window confirming IP blocking ></p> <p><input checked="" type="checkbox"/> IP blocked <input type="checkbox"/> IP allowed <input type="checkbox"/> Not use</p> <p>< Activation of IP blocking></p> <p>Select [IP Blocked] in the IP filtering menu. The window for confirming IP blocking is created. If you click the [OK] button, IP blocking will be activated.</p>
2	<p>Add blocked IP</p>  <p><IP address input></p> <p>Click [Add] in the IP edition menu. When the input window for IP address is created, input the start and end IP of the IP address to block off. -If there is just one IP address to block off, enter the same start IP and end IP. If you click the [Add] button, the range of the input IP will be displayed in the IP filtering setting screen. If you click the [Cancel] button, the input window for IP address will be canceled and the IP address to block off will not be added.</p>
3	<p>Registration</p>  <p>If you click the [Add] button in the above 2, the window indicating registration is done will be created. If you click the [OK] button, you can check the set value in the IP filtering setting screen.</p>

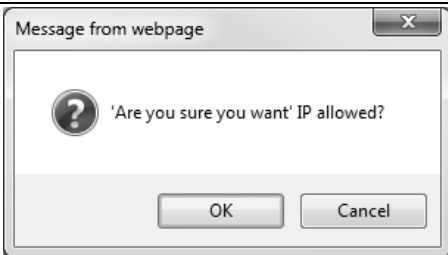
(2) Addition of IP permission

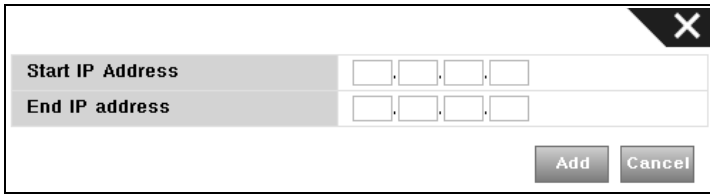
IP permission is the function to allow that the registered IP only access to the web server by registering specific IP addresses. The procedures are as shown below.

Procedures	Description	
<p>1</p> <p>IP permission</p>		<p>Click [SETTING] → [IP FILTERING] in the webpage to move to the IP filtering setting page.</p>  <p>< Window confirming IP permission ></p> <p><input type="checkbox"/> IP blocked <input checked="" type="checkbox"/> IP allowed <input type="checkbox"/> Not use</p> <p>< Activation of IP permission ></p>
		<p>Select [IP permission] in the IP filtering menu. Then, the window confirming whether changing into [IP permission] will pop up. If you click the OK button, [IP permission] will be activated.</p>
<p>2</p> <p>Add allowed IP</p>		 <p>< IP edition menu ></p>  <p><IP address input ></p>
		<p>Click [Add] in the IP edition menu. If the input window for IP address is created, enter the start and end IP of the IP address to block off. -If there is just one IP address to allow, enter the same start IP and end IP. If you click the [Add] button, the input IP range will be displayed in the IP filtering setting screen. If you click the [Cancel] button, the input window for IP address will be canceled and the IP address will not be added.</p>
<p>3</p> <p>Registration of blocked IP is done</p>		
		<p>If you click the [Add] button in the above 2, the window indicating registration is done will be created. If you click the [OK] button, you can check the set value in the IP filtering setting screen.</p>

Notice

(1) If you cannot access to the web server due to wrong IP input during using IP permission or IP blocking function, you can access to the web server with the IP input to the host table setting of the embedded FEnet's basic setting.

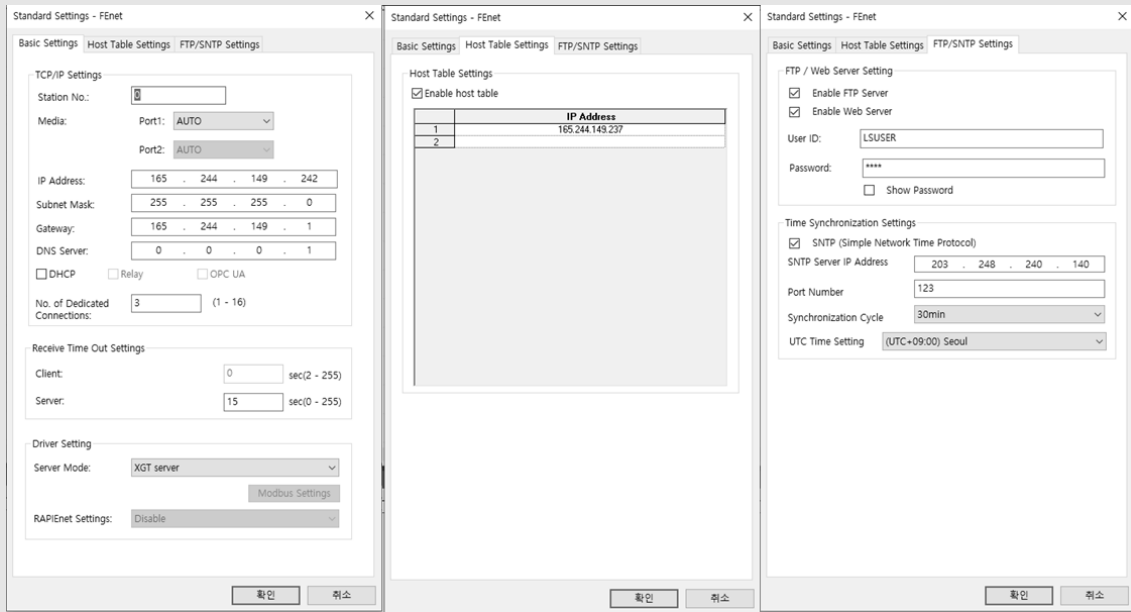

(2) After accessing to the web server with the administrator account in the PC that is relevant to the IP input in the host table setting window as described above, if you modify the wrong IP address in the IP filtering function, you can access to the web server normally.

(3) When setting the IP in the host table to access to the web server, you can access to the web server from the PC with the IP address without checking [Enable host table].

(3) Edition and Deletion

It is the function to change or delete IPs after executing IP blocking and permission as shown below. The same edition and deletion methods are applied to IP permission.

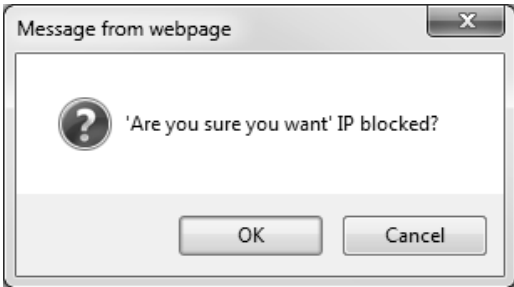
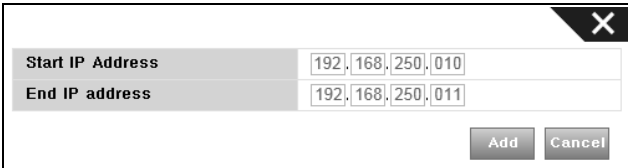
Procedures	Description	
1	Click [Setup] → [IP filtering setting] in the webpage to move to the IP filtering setting page.	
1	IP blocking	 <p style="text-align: center;"><Window confirming IP blocking></p> <div style="border: 1px solid gray; padding: 5px; width: fit-content; margin: auto;"> <input checked="" type="checkbox"/> IP blocked <input type="checkbox"/> IP allowed <input type="checkbox"/> Not use </div> <p style="text-align: center;">< Activation of IP blocking></p> <p>Select 'IP blocking' in the IP filtering menu. Then, the window confirming whether changing into 'IP blocking' will pop up. If you click the OK button, 'IP blocking' will be activated.</p>
2	Edit IP	<div style="text-align: center; margin-bottom: 10px;"> Add Edit Delete </div> <p style="text-align: center;">< IP edition menu></p>  <p style="text-align: center;"><IP address input></p> <p>Click the IP address list to edit. Click [Edit] in the IP edition menu. Change the IP address. If you click the [Edit] button, the changed IP range will be displayed in the IP filtering setting screen. If you click the [Cancel] button, the edition window for IP address will be canceled and the IP address will not be changed.</p>

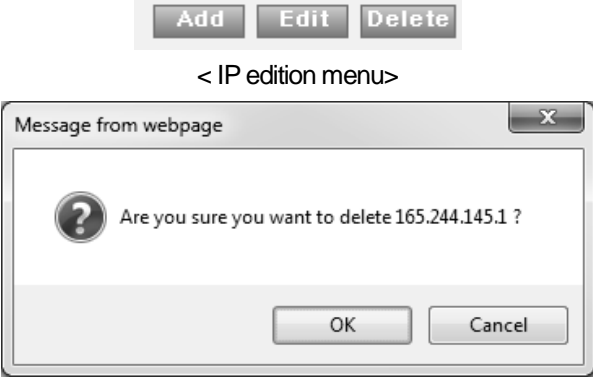
Procedures	Description	
3	Delete IP	<div style="text-align: center;">  <p>< IP edition menu ></p> <p>Message from webpage</p> <p>Are you sure you want to delete 165.244.145.1 ?</p> <p>OK Cancel</p> <p><Message confirming deletion></p> </div>
<p>Click the IP address list to delete. Click [Delete] in the IP edition menu. Then, the window asking whether deleting the IP will pop up. If you click the [OK] button, the selected IP will be deleted. If you click the [Cancel] button, the selected IP will not be deleted.</p>		

(4) Not use

The IP filtering Disable is the item setting that IP filtering function is not in use. It is set as default on a web server and the setting method is as shown below.

Procedures	Description	
1	Click [Setup] → [IP filtering setting] in the webpage to move to the IP filtering setting page.	
2	Disable	<div style="text-align: center;"> <p><Window confirming IP filtering Disable ></p> <p><input type="checkbox"/> IP blocked <input type="checkbox"/> IP allowed <input checked="" type="checkbox"/> Not use</p> <p>< Activation of IP filtering Disable ></p> </div> <p>Select [Not Use] in the IP filtering menu. Then, the window confirming whether changing into [Not Use] will pop up. If you click the OK button, [Not Use] will be activated.</p>

Chapter 3 Web Server

3) Time setting

It is the function to set the PLC's time by accessing to the web server. If you set up time in the web page, the set time will be reflected in the PLC. Time setting methods can be divided into automatic synchronization through the SNTP server and manual setting. When the SNTP time synchronization function is activated in the embedded FEnet's basic setting items, you cannot use the manual time setting. If you want to use the time setting function, cancel the SNTP in XG5000 first.

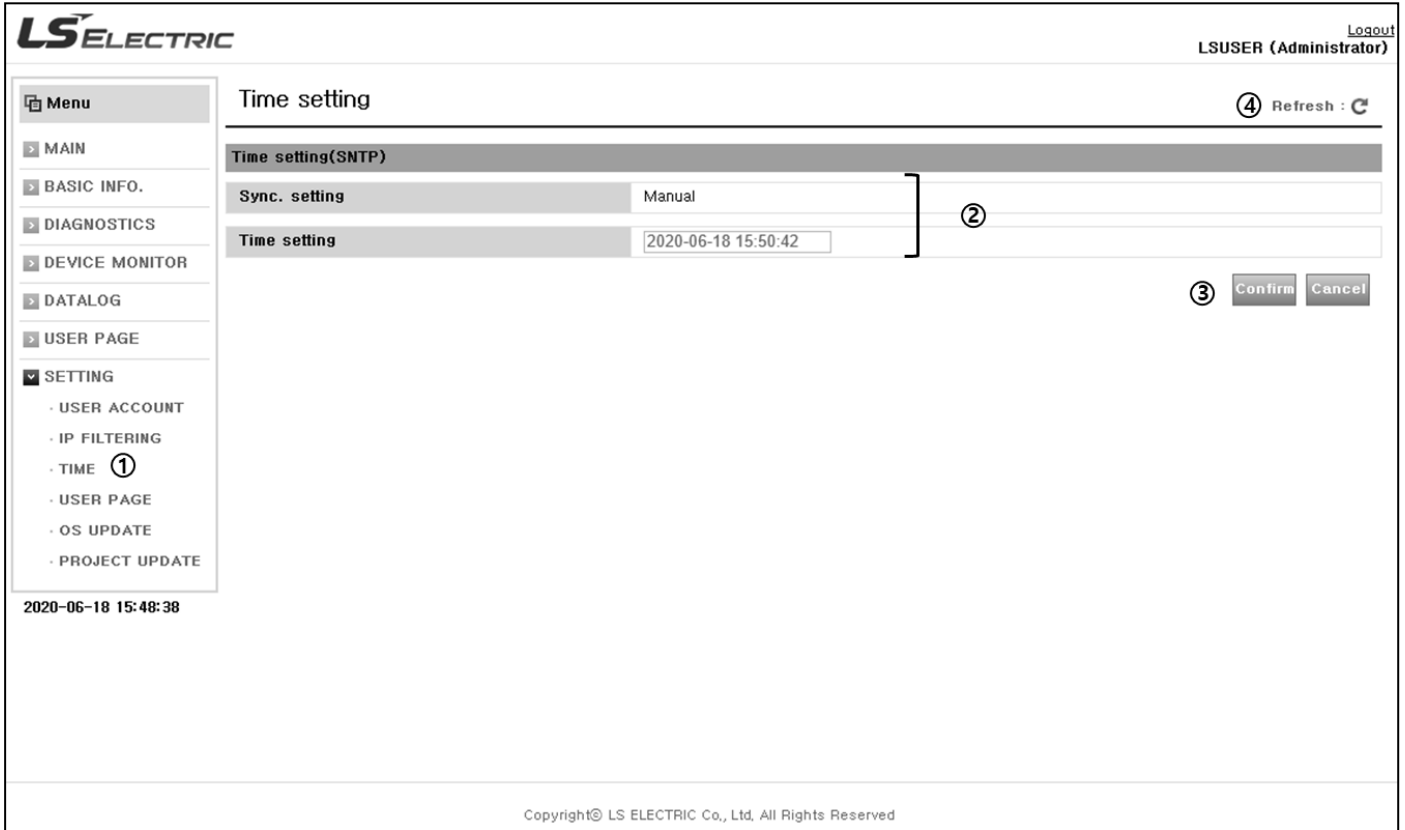

No.	Screen configuration	Description	Remarks
1	Time	Moving to the time setting page	
2	Time setting (SNTP)	Sync. setting	Displaying the method of synchronization setup (manual or auto)
		Time setting	The area for time setting is activated only when synchronization setup is performed manually
3	Confirm, Cancel	To confirm or cancel time setting	
4	Refresh	If you click the 'Refresh' button, the window will be updated into the final screen.	

(1) Using the automatic synchronization(SNTP) function

Through the automatic synchronization function (SNTP), you can check the details of SNTP setting when SNTP works. To use this function, among the embedded FEnet basic setting items, the SNTP time synchronization function should be checked in time synchronization setting.

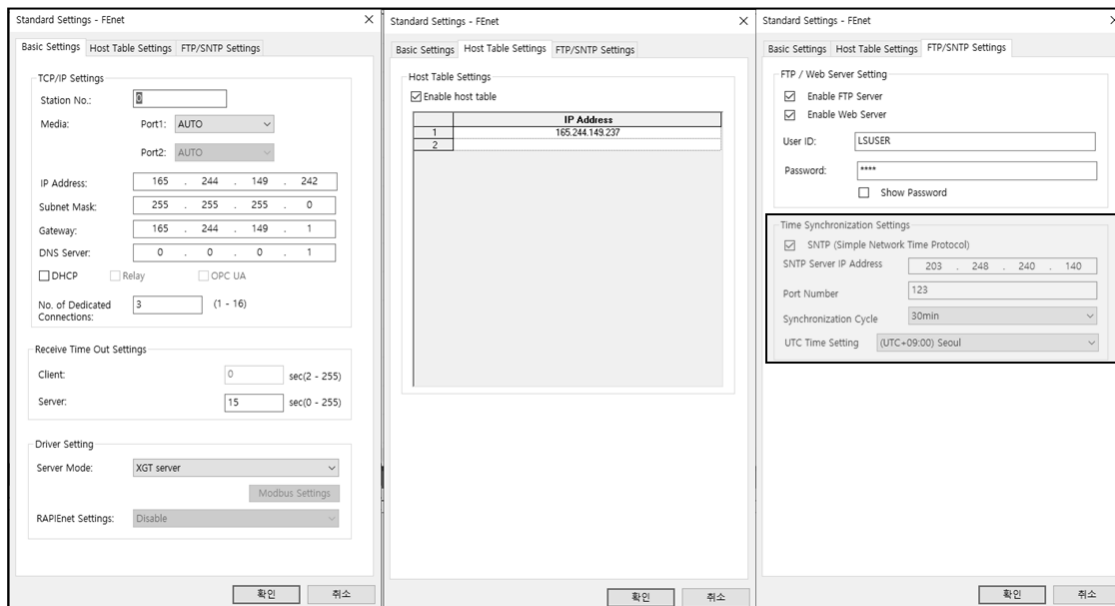

The screen configuration and details on the automatic synchronization function are as shown below.

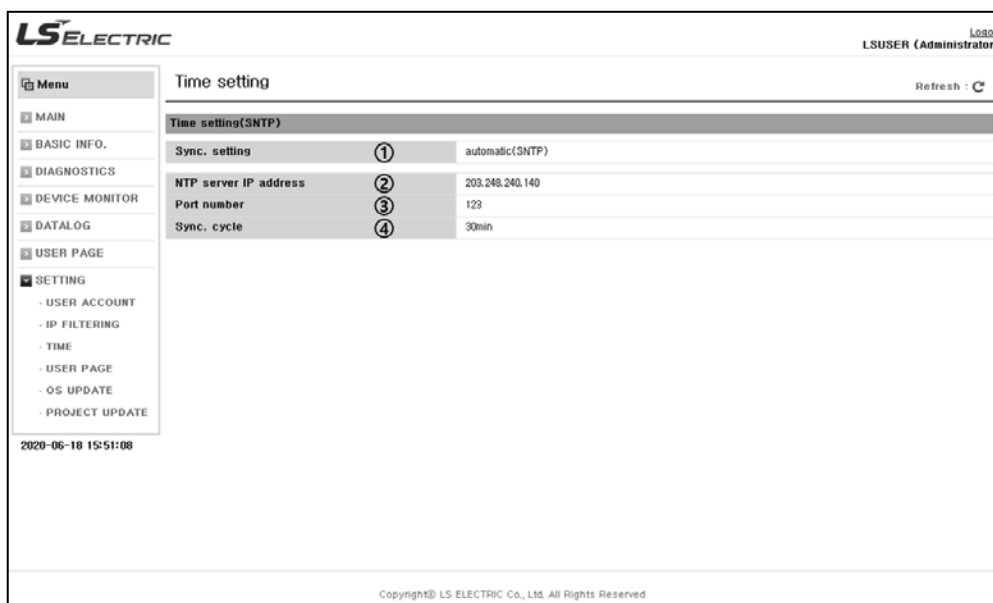

No.	Screen configuration	Description	Remarks
1	Sync. setting	Indicates automatic synchronization is set up.	
2	NTP server IP Address	IP address of the set NTP server	
3	Port Number	Set port number	
4	Sync. cycle	Automatic synchronization cycle	Cycle: 30 minutes, 1 hour, 2 hours, 5 hours, 10 hours, 1 day

Notice

Among the embedded FEnet basic setting items, if the SNTP time synchronization function is not checked in the time synchronization setting, the manual time setting window will be seen instead of the automatic synchronization window.

(2) Manual synchronization function

It is the function for a user to set up the PLC's time personally. The screen configuration and details are as shown below.

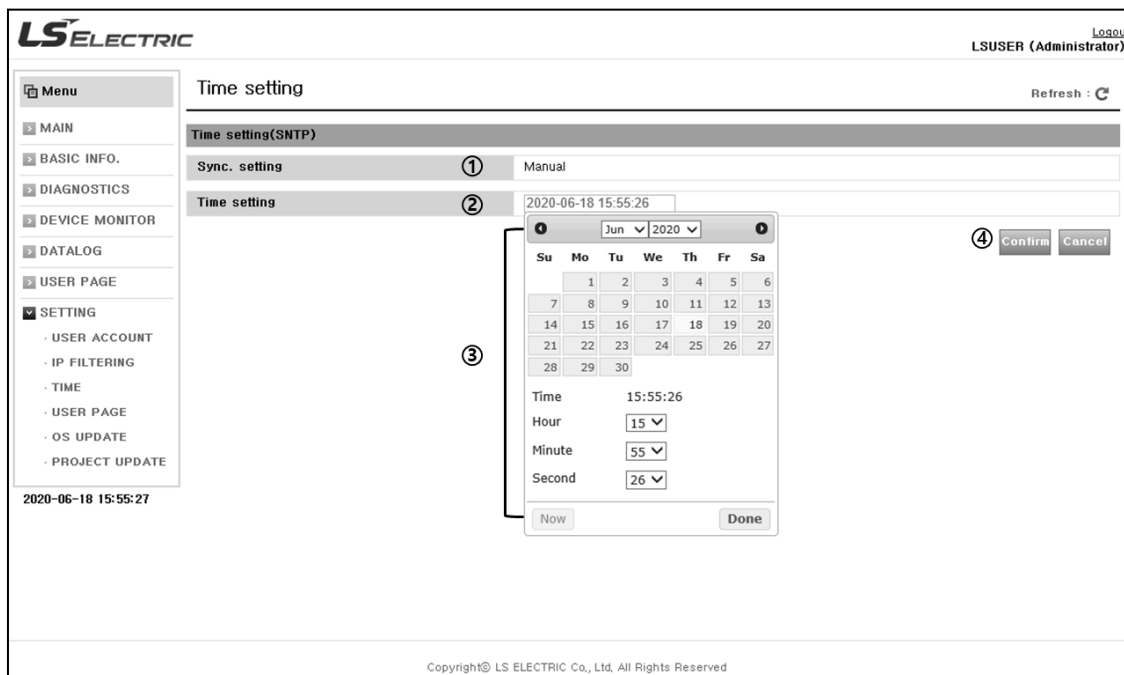

No.	Screen configuration	Description	Remarks
1	Sync. setting	It indicates synchronization is set up manually.	
2	Time setting	Setting the time	
3	Details of time setting	Date and time	Setting the date and time
		Synchronization with local time	Synchronizing the time with the local PC's data and time
		Done	Closing the time setting box
4	Confirm, Cancel	If you click the[Confirm] button, the time will be synchronized with the set value.	

Notice

(1) In the mobile environment, there is a possibility that the user's page registration function does not work properly.

4) User page

It is the function to send the web page file made by a user to the server or manage files of the web server. The screen configuration and details are as shown below.

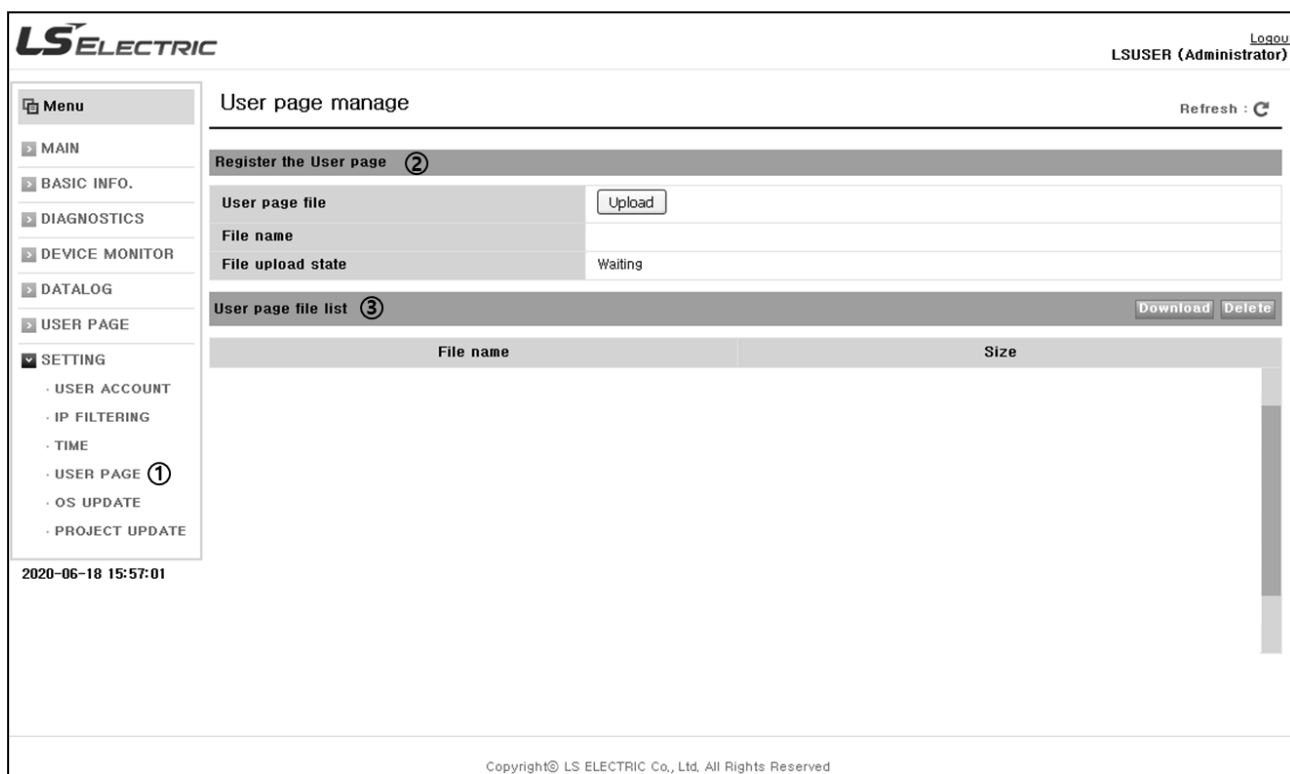

No.	Screen configuration	Description	Remarks
1	USER PAGE	Moving to the user page	
2	Register the User page	Registering the user page	
3	User page file list	Displaying the user page file list You can download and delete the list here.	

(1) Registration of the user page

It is the function to register the web page made by a user in the web server as shown below procedures.

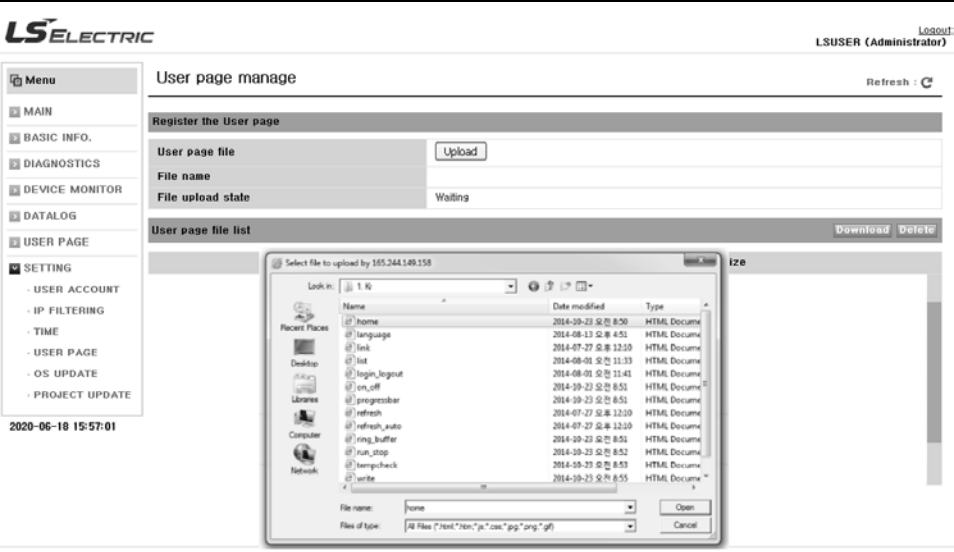
Procedures	Description
1	Click [SETTING] → [USER PAGE] in the web page to move to the 'User page manage'
2	<div style="display: flex; align-items: center;"> <div style="writing-mode: vertical-rl; transform: rotate(180deg); margin-right: 10px;">Add file</div> <div style="flex-grow: 1;">  <p>The screenshot shows the 'User page manage' interface. On the left is a navigation menu with 'SETTING' selected. The main area has a 'Register the User page' section with an 'Upload' button. Below it is a 'User page file list' table. A file selection dialog is overlaid on the page, showing a list of files to be uploaded. The 'File name' field is set to 'home' and the 'File type' is set to 'All files (*.*)'. The dialog also shows a list of files with columns for Name, Date modified, and Type.</p> </div> </div> <p>Click [User page file]- [Upload] After selecting the file to add, click [Open]. When the file transfer is completed, the list of uploaded files will be displayed in [User page file list].</p>

Notice

- (1) The main page name of the user page should be 'home.html'.
- (2) The user page does not support the folder structure.
- (3) The length of the file name when the file upload, please within 32 characters.
- (4) In the mobile environment, there is a possibility that the user's page registration function does not work properly.
- (5) The user page file name must be in English.

(2) User page file download

It is the function to download the user page file registered in the web server as shown below procedures.

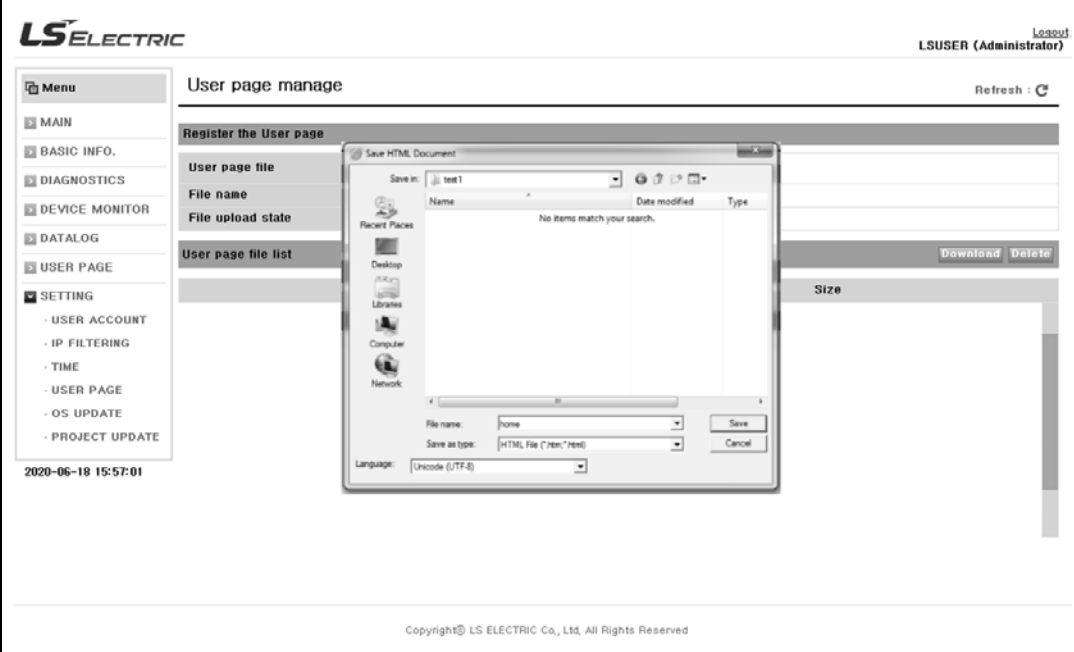
Procedures	Description
1	Click [SETTING] → [USER PAGE] in the web page to move to the 'User page manage'
2	Select the file to download from the user page file list.
3	<div style="display: flex; align-items: center;"> <div style="writing-mode: vertical-rl; transform: rotate(180deg); padding-right: 10px;">file download</div>  </div> <p>Click [User page file list]-[Download]. After selecting the location where the file is saved, click the [Save] button.</p>

Notice

- (1) Download methods of the user page may be different depending on the web browser (Internet Explorer, Chrome, Firefox).
- (2) User page file download might not work well in mobile circumstance.

Chapter 3 Web Server

(3) Deletion of the user page file

It is the function to delete the selected file among registered user page files as shown below procedures.

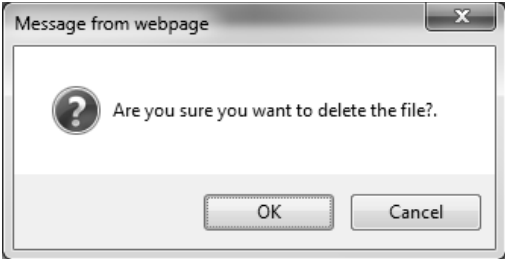
Procedures	Description	
1	Click [SETTING] → [USER PAGE] in the web page to move to the 'User page manage'	
2	Select the file to delete from the user page file list.	
3	Delete File	
		<p>Click [User page file list]- [Delete].</p> <p>If you click the [OK] button after the dialog box asking whether delete or not is created, the relevant file will be deleted from the user page file list.</p>

5) OS update

The OS Update page provides the ability to update the PLC OS via a web server with PLC OS files. Screen composition and contents are as follows.

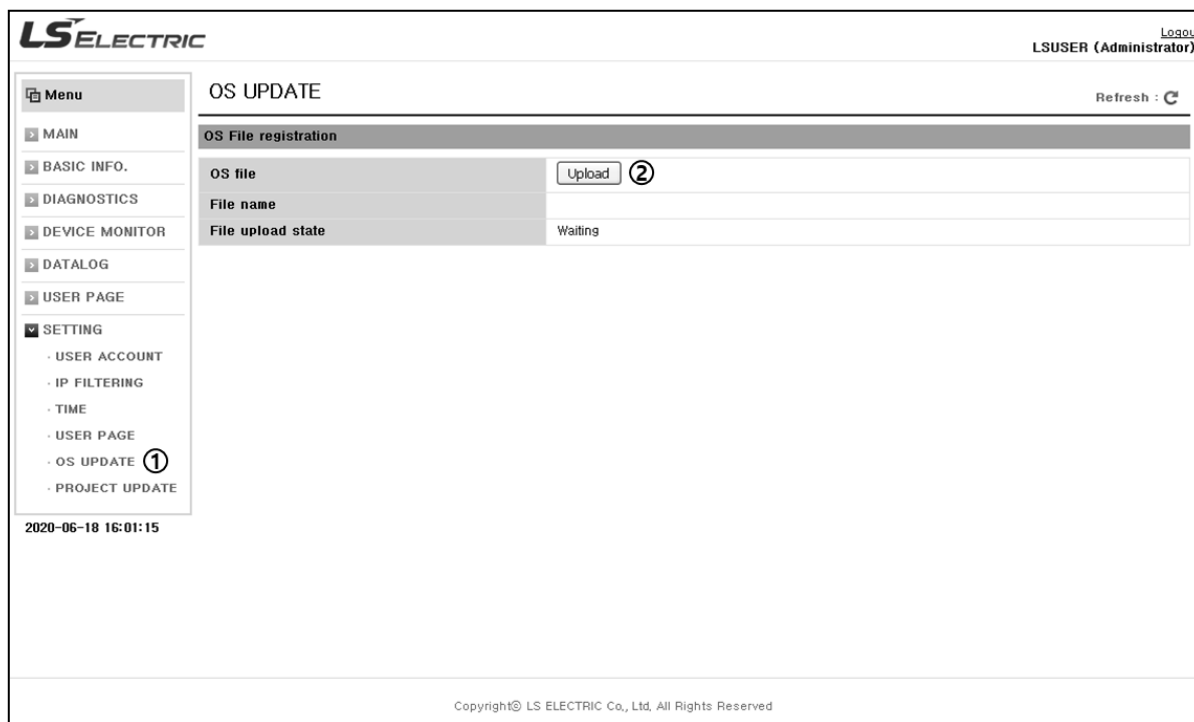

No	Screen configuration	Description	Remarks
1	OS update page	This button takes you to the OS update page.	
2	OS file registration	This is to register OS file.	

Chapter 3 Web Server

(1) OS file registration

This function registers OS file as web server. How to use is as follows.

Procedures	Description
1	Click [Settings] → [OS Update] on the web page to go to the OS update registration page.
2	<div style="display: flex; align-items: flex-start;"> <div style="flex: 1; padding-right: 10px;"> <p style="text-align: center;">Select file</p> </div> <div style="flex: 2;">  </div> </div> <ol style="list-style-type: none"> 1) Click [Select File] in [OS Update Page]. Select the file you want to add and click Open. 2) If the file transfer is completed and the transferred file is a valid file, the PLC automatically updates the OS.

(2) Project update

The project update page provides the function to update the XG5000 PLC Project file through the web server. Screen composition and contents are as follows.

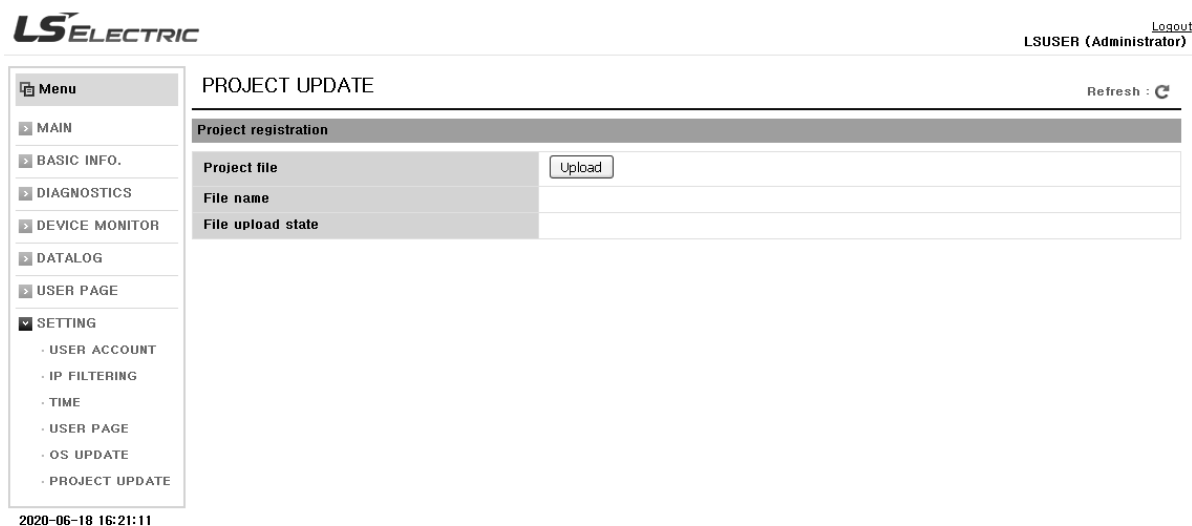

No	Screen configuration	Description	Remarks
1	Project update page	This button takes you to the project update page.	
2	Register project file	This is the part to register project file.	

(3) Project file registration
project files as a web server. How to use is as follows.

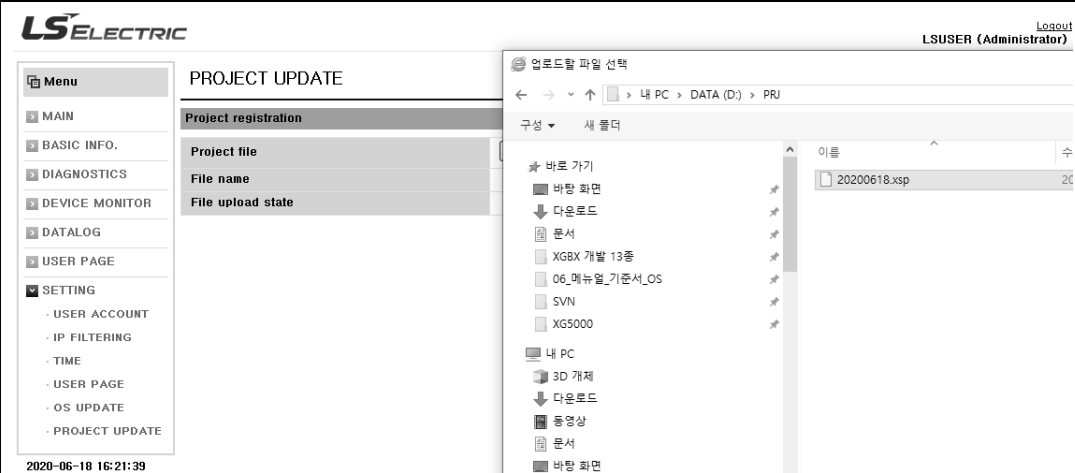
Procedures	Description
1	Click [Settings] → [Project Update] on the web page to go to the project update registration page.
2	<div style="display: flex; align-items: center;"> <div style="width: 15%; text-align: center; vertical-align: middle;"> <p>Select file</p> </div> <div style="width: 85%;">  </div> </div> <p>1) Click [Select File] on the [Project Update Page]. Select the file you want to add and click Open.</p> <p>2) If the file transfer is completed and the transferred file is a valid file, the PLC automatically updates the project.</p>

3.5 Improvement of the web server's speed

The web server adopted by XGB high-performance PLC module is supposed to send one data packet per one scan to minimize the impact on scan time. In this structure, if the response to the sent data packet is not immediately received, the next packet will not be sent until the response is received. However, in the case of Windows, when receiving data packets, generally, it is supposed to wait until 2 packets are received and send responses without responding to all packets or send the response in 20ms. Therefore, if you operate the web server in Windows without changing the registry, the communication speed will decrease.

To improve the web server's speed, it is recommended that you set up the register as shown below so that ACK is sent every time the Windows' TCP/IP receives one packet. The method to change registers can be divided into automatic change through the communication setting file provided by the web server and direct change.

3.5.1 How to set up registers using the web server communication settings

You can change registers using the communication setting function as shown below.

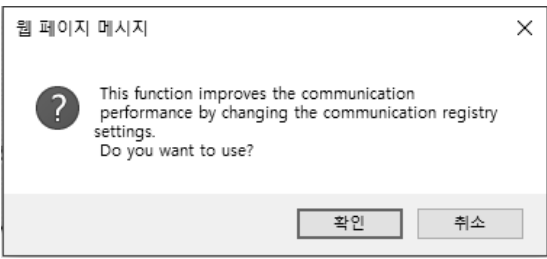
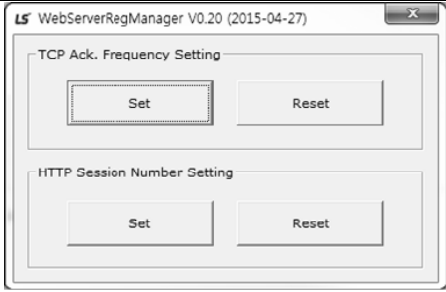
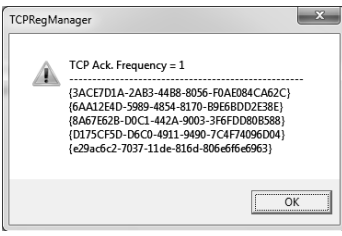
Procedure	Description	
1	File download	
1) Click '[COMM. SETTING]' in the MAIN page. 2) If the web page's message pops up, click the OK button. 3) If you click the button, the TCPRegManager.zip file will be downloaded.		
2	Program execution	
1) If you unzip and execute the file after downloading the file, the program will be executed as shown above Web serverRegManager window. 2) Click the '[Set]' button in TCP Ack. Frequency Setting box.		
3	Registry Setting	
1) If you click the '[Set]' button, the TCP Ack Frequency registry will be set up. 2) If you click the '[OK]' button in Tcp Ack. Frequency setting window, setup will be completed.		

3.5.2 How to change registers using the modification tools

- 1) Select the [Start] button of Windows for execution.(Shortcut key /Windows key + R)
- 2) Input 'regedit' to the execution window and run the process.

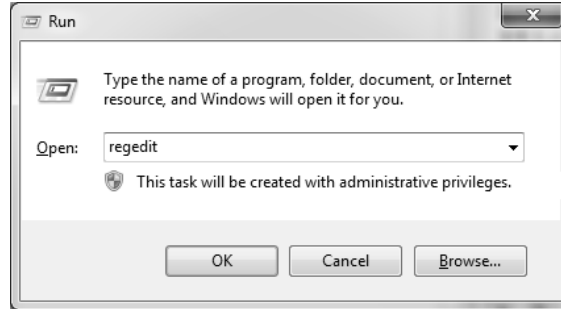

- 3) Check the below path.
 HKEY_LOCAL_MACHINE\SYSTEM\CurrentControlSet\services\Tcpip\Parameters\Interfaces
- 4) Depending on the devices installed in the PC, You can see the folders are created as shown below

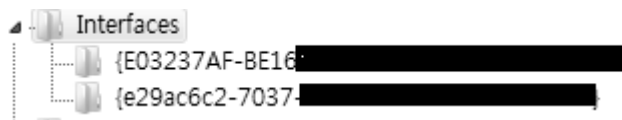

- 5) If there are several register folders, select one by one and find the folder where the current PC's IP address is set in the right register value.

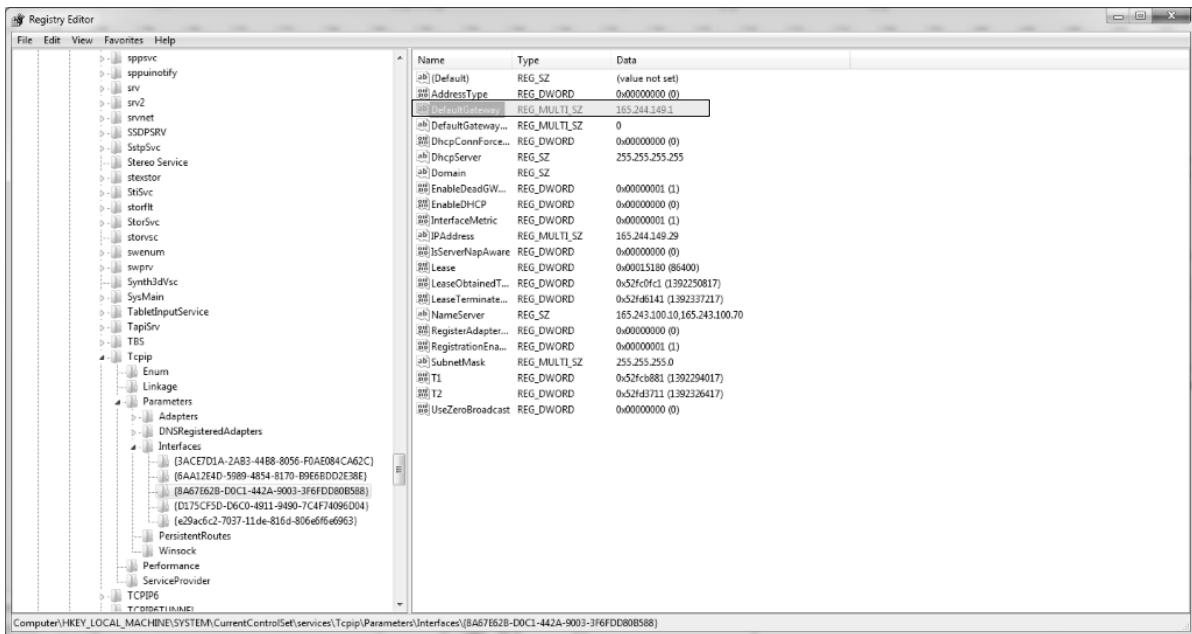

6) Click with the right mouse button on the right screen of the relevant folder and select New]→[DWORD(32bit) value].

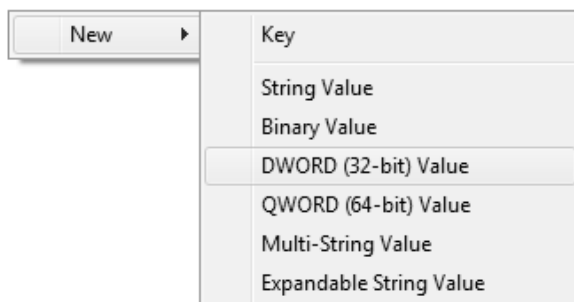

7) Enter the value name as shown below.

- Value name: TcpAckFrequency (It should be case-sensitive.)

8) Double-click the created register and enter 1 to the value data.

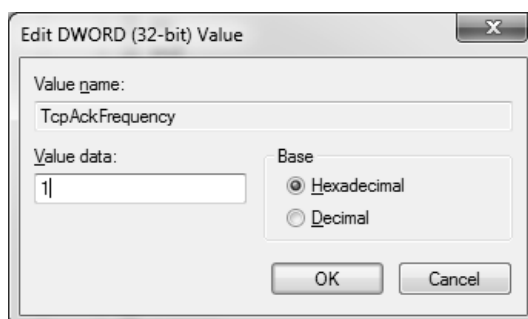

9) Reboot the computer.

3.6 Directions for use of the web server

When you access to the web server for the first time, the below message will be created (message box may be different depending on the web browser types). If you click the button, the confirmation message window will be created as shown below. (The message details are all different).

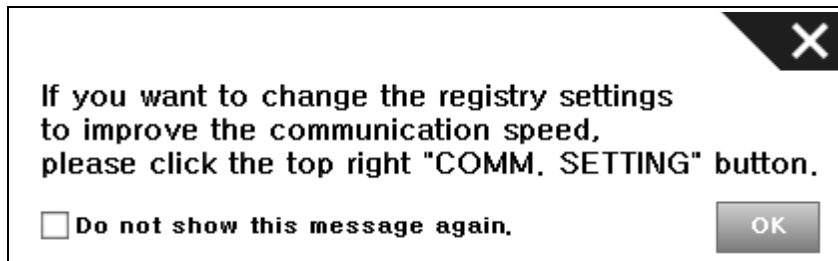

<Internet Explorer's message>

If the above message window appears repetitively in some web browsers(Chrome, Firefox), the checkbox that can make the additional message invisible any more will be created in the window.

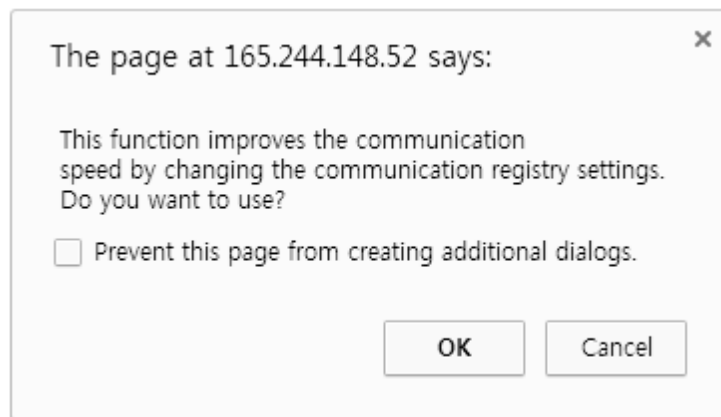

At this time, if you click the checkbox and click the same function later, the confirmation message will not pop up any more so you may not use the function. Accordingly, although the checkbox is created, do not click it.

If you click the checkbox, close the web browser and open it again. Otherwise, if you create a new tab and access to the web server again, the confirmation message will be created again.

Appendix 1 Flag list

Appendix 1.1 Special Relay (F) List

Word	Bit	Variables	Function	Description
%FW0~1	%FD0	_SYS_STATE	Mode and state	Indicates PLC mode and operation State.
	%FX0	_RUN	Run	Run state.
	%FX1	_STOP	Stop	Stop state.
	%FX2	_ERROR	Error	Error state.
	%FX3	_DEBUG	Debug	Debug state.
	%FX4	_LOCAL_CON	Local control	Local control mode.
	%FX6	_REMOTE_CON	Remote mode	Remote control mode.
	%FX8	_RUN_EDIT_ST	Editing during RUN	Editing program download during RUN.
	%FX9	_RUN_EDIT_CHK	Editing during RUN	Internal edit processing during RUN.
	%FX10	_RUN_EDIT_DONE	Edit done during RUN	Edit is done during RUN.
	%FX11	_RUN_EDIT_END	Edit end during RUN	Edit is ended during RUN.
	%FX12	_CMOD_KEY	Operation mode	Operation mode changed by key.
	%FX13	_CMOD_LPADT	Operation mode	Operation mode changed by local PADT.
	%FX14	_CMOD_RPADT	Operation mode	Operation mode changed by Remote PADT.
	%FX15	_CMOD_RLINK	Operation mode	Operation mode changed by Remote communication module.
	%FX16	_FORCE_IN	Forced input	Forced input state.
	%FX17	_FORCE_OUT	Forced output	Forced output state.
	%FX20	_MON_On	Monitor	Monitor on execution.
	%FX21	_USTOP_On	Stop	Stop by Stop function.
	%FX22	_ESTOP_On	EStop	Stop by EStop function.
%FX24	_INIT_RUN	Initialize	Initialization task on execution.	
%FX28	_PB1	Program Code 1	Program Code 1 selected.	
%FX29	_PB2	Program Code 2	Program Code 2 selected.	
%FW2~3	%FD1	_CNF_ER	System error	Reports heavy error state of system.
	%FX33	_IO_TYER	Module Type error	Module Type does not match.
	%FX34	_IO_DEER	Module detachment error	Module is detached.
	%FX36	_IO_RWER	Module I/O error	Module I/O error.
	%FX37	_IP_IFER	Module interface error	Special/communication module interface error.
	%FX38	_ANNUM_ER	External device error	Detected heavy error in external Device.
	%FX40	_BPRM_ER	Basic parameter	Basic parameter error.
	%FX41	_IOPRM_ER	IO parameter	I/O configuration parameter error.
	%FX42	_SPPRM_ER	Special module parameter	Special module parameter is Abnormal.
	%FX43	_CPPRM_ER	Communication module parameter	Communication module parameter is abnormal.
	%FX44	_PGM_ER	Program error	Program error.
	%FX45	_CODE_ER	Code error	Program Code error.
%FX46	_SWDT_ER	System watchdog	System watchdog operated.	
%FX48	_WDT_ER	Scan watchdog	Scan watchdog operated.	

Word	Bit	Variable	Function	Description
%FW4-5	%FD2	_CNF_WAR	System warning	Reports light error state of system.
	%FX64	_RTC_ER	RTC error	RTC error
	%FX65	_DBCK_ER	Backup error	Data backup error.
	%FX67	_ABSD_ER	Operation shutdown error	Stop by abnormal operation.
	%FX68	_TASK_ER	Task error	Task error
	%FX69	_BAT_ER	Battery error	Battery error
	%FX70	_ANNUM_WAR	External device error	Detected light error of external device.
	%FX72	_HS_WAR1	High speed link 1	High speed link – parameter 1 error.
	%FX73	_HS_WAR2	High speed link 2	High speed link – parameter 2 error.
	%FX84	_P2P_WAR1	P2P parameter 1	P2P – parameter 1 error.
	%FX85	_P2P_WAR2	P2P parameter 2	P2P – parameter 2 error.
	%FX86	_P2P_WAR3	P2P parameter 3	P2P – parameter 3 error.
%FX92	_CONSTANT_ER	Constant error	Constant error.	
%FW8	%FX128	_CONSTANT_RUN	Constant operation	Constant operation
%FW9	-	_USER_F	User contact	Timer used by user.
	%FX144	_T20MS	20ms	20ms cycle Clock.
	%FX145	_T100MS	100ms	As a clock signal available at user program, it reverses On/Off every half period. Since clock signal is dealt with at the end of scan, there may be delay or distortion according to scan time. So use clock that's longer than scan time. Clock signal is Off status at the start of scan program and task program. _T100ms clock
	%FX146	_T200MS	200ms	
	%FX147	_T1S	1s Clock	
	%FX148	_T2S	2 s Clock	
	%FX149	_T10S	10 s Clock	
	%FX150	_T20S	20 s Clock	
	%FX151	_T60S	60 s Clock	
	%FX153	_On	Ordinary time On	Always On state Bit.
	%FX154	_Off	Ordinary time Off	Always Off state Bit.
	%FX155	_1On	1scan On	First scan On Bit.
	%FX156	_1Off	1scan Off	First scan OFF bit.
%FX157	_STOG	Reversal	Reversal every scan.	
%FW11	-	_LOGIC_RESULT	Logic result	Indicates logic results.
	%FX176	_ER	operation error	On during 1 scan in case of operation error.
	%FX179	_ALL_Off	All output OFF	On in case that all output is Off.
	%FX181	_LER	operation error	On in case of operation error.
%FW13	-	_AC_F_CNT	Power shutdown times	Saves the times of power shutdown.
%FW14	-	_FALS_NUM	FALS no.	Indicates FALS no.
%FW15	-	_PUTGET_ERR0	PUT/GET error 0	Main base Put / Get error.
%FW23	-	_PUTGET_NDR0	PUT/GET end 0	Main base Put/Get end.
%FW44	-	_CPU_TYPE	CPU Type	Indicates information for CPU Type.
%FW45	-	_CPU_VER	CPU version	Indicates CPU version.
%FD23	-	_OS_VER	OS version	Indicates OS version.
%FD24	-	_OS_DATE	OS date	Indicates OS distribution date.
%FW50	-	_SCAN_MAX	Max. scan time	Indicates max. scan time.
%FW51	-	_SCAN_MIN	Min. scan time	Indicates min. scan time.
%FW52	-	_SCAN_CUR	Current scan time	Current scan time.
%FW53	-	_MON_YEAR	Month/year	Clock data (month/year)
%FW54	-	_TIME_DAY	Hour/date	Clock data (hour/date)
%FW55	-	_SEC_MIN	Second/minute	Clock data (Second/minute)
%FW56	-	_HUND_WK	Hundred year/week	Clock data (Hundred year/week)

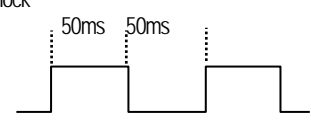

Appendix1 Flag List

Word	Bit	Variable	Function	Description
%FD30	-	_REF_COUNT	Refresh	Increase when module Refresh.
%FD31	-	_REF_OK_CNT	Refresh OK	Increase when module Refresh is normal.
%FD32	-	_REF_NG_CNT	Refresh NG	Increase when module Refresh is Abnormal.
%FD40	-	_BUF_FULL_CNT	Buffer Full	Increase when CPU internal buffer is full.
%FD41	-	_PUT_CNT	Put count	Increase when Put count.
%FD42	-	_PUT_CNT	Put count	Increase when Put count.
%FD43	-	_GET_CNT	Get count	Increase when Get count.
%FD44	-	_KEY	Current key	indicates the current state of local key.
%FW90	-	_KEY_PREV	Previous key	indicates the previous state of local key
%FW91	-	_IO_TYER_N	Mismatch slot	Module Type mismatched slot no.
%FW93	-	_IO_RWER_N	RW error slot	Module read/write error slot no.
%FW95	-	_IP_IFER_N	IF error slot	Module interface error slot no.
%FW96	-	_IO_TYER0	Module Type 0 error	Main base module Type error.
%FW104	-	_IO_DEER_N	Detach slot	Module detached slot no.
%FW120	-	_IO_RWER_N	RW error slot	Module read/write error slot no.
%FW128	-	_IP_IFER_N	IF error slot	Module interface error slot no.
%FW136		_RTC_DATE	RTC current date	RTC current date
%FW137		_RTC_WEEK	RTC current day	RTC current day
%FD69		_RTC_TOD	RTC current time	RTC current time(ms)
%FD70	-	_AC_FAIL_CNT	Power shutdown times	Saves the times of power shutdown.
%FD71	-	_ERR_HIS_CNT	Error occur times	Saves the times of error occur.
%FD72	-	_MOD_HIS_CNT	Mode conversion times	Saves the times of mode conversion.
%FD73	-	_SYS_HIS_CNT	History occur times	Saves the times of system history.
%FD74	-	_LOG_ROTATE	Log Rotate	Saves log rotate information.
%FD92	-	_PLC_OPERATING_TIME	PLC operation time storage	Stores the time when PLC is turned on in seconds.
%FW150	-	_BASE_INFO0	Slot information 0	Main base slot information.
%FW158	-	_RBANK_NUM	Current using block number	Current using R area
%FW159	-	_RBLOCK_STATE	Flash block state	Flash memory operation state
%FD80		_RBLOCK_RD_FLAG	Flash read state	ON when reading N area in flash
%FD81		_RBLOCK_WR_FLAG	Flash write state	ON when writing N area in flash
%FD82		_RBLOCK_ER_FLAG	Flash error state	ON when error in N area in flash
%FD89		_OS_VER_PATCH	OS version patch	OS version patch
%FW200		_USER_WRITE_F	Usable coil	Usable coil in program
	%FX3200	_RTC_WR	RTC RW	Data write and read in RTC.
	%FX3201	_SCAN_WR	Scan WR	Initializing the value of scan.
	%FX3202	_CHK_ANC_ERR	Request detection of external serious error	Request detection of external error.
	%FX3203	_CHK_ANC_WAR	Request detection of external slight error (warning)	Request detection of external slight error (warning).
%FW201		_USER_STAUS_F	User contact point	User contact point.
	%FX3216	_INIT_DONE	Initialization completed	Initialization complete displayed.
%FW202	-	_ANC_ERR	Display information of external serious error	Display information of external serious error
%FW203	-	_ANC_WAR	Display information of external slight error (warning)	Display information of external slight error (warning)
%FW210	-	_MON_YEAR_DT	Month/year	Clock data (month/year)
%FW211	-	_TIME_DAY_DT	Hour/date	Clock data (hour/date)
%FW212	-	_SEC_MIN_DT	Second/minute	Clock data (Second/minute)
%FW213	-	_HUND_WK_DT	Hundred year/week	Clock data (Hundred year/week)
%FW272	%FX4352	_ARY_IDX_ERR	Array index error	Array index range exceed error
%FW274	%FX4384	_ARY_IDX_LER	Array index latch	Array index range exceed error

Notice

- The PLC run time save flag (% FD92) is initialized when a data backup error occurs.

Appendix 1.2 Communication Relay (L) List

Here describes data link communication relay(L).

(1) High-speed Link 1

Device	Keyword	Type	contents	Description
%LX0	_HS1_RLINK	bit Array	High speed link parameter 1 normal operation of all station	Indicates normal operation of all station according to parameter set in High speed link, and On under the condition as below. 1. In case that all station set in parameter is RUN mode and no error, 2. All data block set in parameter is communicated normally, and 3. The parameter set in each station itself is communicated normally. Once RUN_LINK is On, it keeps On unless stopped by LINK_DISABLE.
%LX1	_HS1_LTRBL	bit Array	Abnormal state after _HS1RLINK On	In the state of _HSmRLINK flag On, if communication state of the station set in the parameter and data block is as follows, this flag shall be On. 1. In case that the station set in the parameter is not RUN mode, or 2. There is an error in the station set in the parameter, or 3. The communication state of data block set in the parameter is not good. LINK TROUBLE shall be On if the above 1, 2 & 3 conditions occur, and if the condition return to the normal state, it shall be OFF again.
%LX32 ~ %LX95	_HS1_STATE[k]	bit Array	Indicates total status of High Speed Link no.1 ***th block	Indicates total status of communication information about each data block of parameter _HS1_STATE*** = HS1MOD*** & _HS1TRX*** & (~_HS1_ERR***)
%LX96 ~ %LX159	_HS1_MOD[k]	bit Array	RUN operation mode of High Speed Link parameter no.1 ***th block station	Indicates operation mode of station set in *** data block of parameter
%LX160 ~ %LX223	_HS1_TRX[k]	bit Array	Indicates normal communication with High Speed Link no.1 ***th block station	Indicates whether communication status of *** data block of parameter is normal or not.
%LX224 ~ %LX287	_HS1_ERR[k]	bit Array	Operation error mode of High Speed Link parameter no.1 ***th block station	Indicates whether there is error at communication status of *** data block of parameter
%LX288 ~ %LX767	_HS1_SETBLO CK[k]	bit Array	Indicates High Speed Link parameter no.1 ***th block setting	Indicates whether *** data block of parameter is set or not.

(2) High-speed Link 2~5

High speed link No. 1 ~ 5

Block Number	Address	Note
2	%LX416~%LX767	For each block flags, refer to the table on the preceding page.
3	%LX928~%LX1279	
4	%LX1344~%LX1679	
5	%LX1744~%LX2079	

k that is the block number indicates the information of 64 blocks in the range of 00~63 through 4 words; 16 per 1 word. For example, the mode information(_HS1MOD) indicates the information of the block 0~15 in L0006; the information of block 16~31, 32~47, 48~63 in L0007, L0008, L0009. Accordingly, the mode information of block No. 55 is indicated in L000097.

Appendix1 Flag List

(3) P2P Flag

P2P Parameter:1~3, P2P block: 0~31

Device	Keyword	Type	Description
%LX8192	_P2P1_NDR00	Bit	Indicates P2P parameter 1, 0 Block service normal end.
%LX8193	_P2P1_ERR00	Bit	Indicates P2P parameter 1, 0 Block service abnormal end.
%LW513	_P2P1_STATUS00	Word	Indicates error code in case of P2P parameter 1, 0 Block service abnormal end.
%LD257	_P2P1_SVCCNT00	DWord	Indicates P2P parameter 1, 0 Block service normal count.
%LD258	_P2P1_ERRCNT00	DWord	Indicates P2P parameter 1, 0 Block service abnormal count.
%LX8288	_P2P1_NDR01	Bit	P2P parameter 1, 1 Block service normal end.
%LX8289	_P2P1_ERR01	Bit	P2P parameter 1, 1 Block service abnormal end.
%LW519	_P2P1_STATUS01	Word	Indicates error code in case of P2P parameter 1, 1 Block service abnormal end.
%LD260	_P2P1_SVCCNT01	DWord	Indicates P2P parameter 1, 1 Block service normal count.
%LD261	_P2P1_ERRCNT01	DWord	Indicates P2P parameter 1, 1 Block service abnormal count.

In terms of P2P parameter No.1 block, a total of 32 blocks from No.0 to No.31 exist. The parameters of each block have the same size and display function as the above table.

P2P Number	L Address	Note
1	%LW512~%LW703	For the saving area parameters of each block, refer to the above table.
2	%LW704~%LW895	
3	%LW896~%LW1087	
4	%LW1088~%LW1279	
5	%LW1280~%LW1471	
6	%LW1472~%LW1663	

(4) Network Register (N) List

Here describes Network Register for communication (N). P2P parameter: 1~6, P2P block: 0~31

Device	Keyword	Type	Description
N000	_P1B00SN	Word	Saves another station no. of P2P parameter 1, 00 block.
N0001~0004	_P1B00RD1	Device Structure	Saves area device 1 to read P2P parameter 1, 00 block.
N005	_P1B00RS1	Word	Saves area size 1 to read P2P parameter 1, 00block.
N0006~0009	_P1B00RD2	Device Structure	Saves area device 2 to read P2P parameter 1, 00 block.
N0010	_P1B00RS2	Word	Saves area size 2 to read P2P parameter 1, 00 block.
N0011~0014	_P1B00RD3	Device Structure	Saves area device 3 to read P2P parameter 1, 00 block.
N0015	_P1B00RS3	Word	Saves area size 3 to read P2P parameter 1, 00 block.
N0016~0019	_P1B00RD4	Device Structure	Saves area device 4 to read P2P parameter 1, 00 block.
N0020	_P1B00RS4	Word	Saves area size 4 to read P2P parameter 1, 00 block.
N0021~0024	_P1B00WD1	Device Structure	Saves area device 1 to save P2P parameter 1, 00 block.
N0025	_P1B00WS1	Word	Saves area size 1 to save P2P parameter 1, 00 block.
N0026~0029	_P1B00WD2	Device Structure	Saves area device 2 to save P2P parameter 1, 00 block.
N0030	_P1B00WS2	Word	Saves area size 2 to save P2P parameter 1, 00 block.
N0031~0034	_P1B00WD3	Device Structure	Saves area device 3 to save P2P parameter 1, 00 block.
N0035	_P1B00WS3	Word	Saves area size 3 to save P2P parameter 1, 00block.
N0036~0039	_P1B00WD4	Device Structure	Saves area device 4 to save P2P parameter 1, 00 block.
N0040	_P1B00WS4	Word	Saves area size 4 to save P2P parameter 1, 00 block.
N0041	_P1B01SN	Word	Saves another station no. of P2P parameter 1, 01 block.
N0042~0045	_P1B01RD1	Device Structure	Saves area device 1 to read P2P parameter 1, 01 block.
N0046	_P1B01RS1	Word	Saves area size 1 to read P2P parameter 1, 01 block.
N0047~0050	_P1B01RD2	Device Structure	Saves area device 2 to read P2P parameter 1, 01 block.
N0051	_P1B01RS2	Word	Saves area size 2 to read P2P parameter 1, 01 block.
N0052~0055	_P1B01RD3	Device Structure	Saves area device 3 to read P2P parameter 1, 01 block.
N0056	_P1B01RS3	Word	Saves area size 3 to read P2P parameter 1, 01 block.
N0057~0060	_P1B01RD4	Device Structure	Saves area device 4 to read P2P parameter 1, 01 block.
N0061	_P1B01RS4	Word	Saves area size 4 to read P2P parameter 1, 01 block.
N0062~0065	_P1B01WD1	Device Structure	Saves area device 1 to save P2P parameter 1, 01 block.
N0066	_P1B01WS1	Word	Saves area size 1 to save P2P parameter 1, 01 block.

Appendix1 Flag List

N0067~0070	_P1B01WD2	Device Structure	Saves area device 2 to save P2P parameter 1, 01 block.
N0071	_P1B01WS2	Word	Saves area size 2 to save P2P parameter 1, 01 block.
N0072~0075	_P1B01WD3	Device Structure	Saves area device 3 to save P2P parameter 1, 01 block.
N0076	_P1B01WS3	Word	Saves area size 3 to save P2P parameter 1, 01 block.
N0077~0080	_P1B01WD4	Device Structure	Saves area device 4 to save P2P parameter 1, 01 block.
N0081	_P1B01WS4	Word	Saves area size 4 to save P2P parameter 1, 01 block.

A total of 32 blocks from No.0 to No.31 exist per P2P of No.1 to No.6. The saving parameters of each block have the same size and display function as the above table.

P2P Number	L Address	Note
1	N0000~N1311(Cnet)	For the saving area parameters of each block, refer to the above table.
2	N1312~N2623(Enet)	
3	N2624~N3935(Extension)	
4	N3936~N5247(Extension)	
5	N5248~N6559(HighExtension)	
6	N6560~N7872(HighExtension)	

Notice

- (1) When you set P2P parameters through XG5000, N area is automatically set up.
- (2) The N area is the flash area so it cannot be used as the internal device. (Cannot write)

(5) ASCII(American National Standard Code for Information Interchange)

ASCII		Value	ASCII		Value	ASCII		Value	ASCII		Value
HEX	DEC		HEX	DEC		HEX	DEC		HEX	DEC	
00	000	NULL	40	064	@	20	032	(space)	60	096	`
01	001	SOH	41	065	A	21	033	!	61	097	a
02	002	STX	42	066	B	22	034	"	62	098	b
03	003	ETX	43	067	C	23	035	#	63	099	c
04	004	EQT	44	068	D	24	036	\$	64	100	d
05	005	ENQ	45	069	E	25	037	%	65	101	e
06	006	ACK	46	070	F	26	038	&	66	102	f
07	007	BEL	47	071	G	27	039	'	67	103	g
08	008	BS	48	072	H	28	040	(68	104	h
09	009	HT	49	073	I	29	041)	69	105	i
0A	010	LF	4A	074	J	2A	042	*	6A	106	j
0B	011	VT	4B	075	K	2B	043	+	6B	107	k
0C	012	FF	4C	076	L	2C	044	`	6C	108	l
0D	013	CR	4D	077	M	2D	045	-	6D	109	m
0E	014	SO	4E	078	N	2E	046	.	6E	110	n
0F	015	SI	4F	079	O	2F	047	/	6F	111	o
10	016	DLE	50	080	P	30	048	0	70	112	p
11	017	DC1	51	081	Q	31	049	1	71	113	q
12	018	DC2	52	082	R	32	050	2	72	114	r
13	019	DC3	53	083	S	33	051	3	73	115	s
14	020	DC4	54	084	T	34	052	4	74	116	t
15	021	NAK	55	085	U	35	053	5	75	117	u
16	022	SYN	56	086	V	36	054	6	76	118	v
17	023	ETB	57	087	W	37	055	7	77	119	w
18	024	CAN	58	088	X	38	056	8	78	120	x
19	025	EM	59	089	Y	39	057	9	79	121	y
1A	026	SUB	5A	090	Z	3A	058	:	7A	122	z
1B	027	ESC	5B	091	[3B	059	;	7B	123	{
1C	028	FS	5C	092	\	3C	060	<	7C	124	
1D	029	GS	5D	093]	3D	061	=	7D	125	}
1E	030	RS	5E	094	^	3E	062	>	7E	126	~
1F	031	US	5F	095	_	3F	063	?	7F	127	□

Appendix 2 Dimension (Unit : mm)

(1) CPU Type

- XEC-DN32U, XEC-DP32U, XEC-DR28U

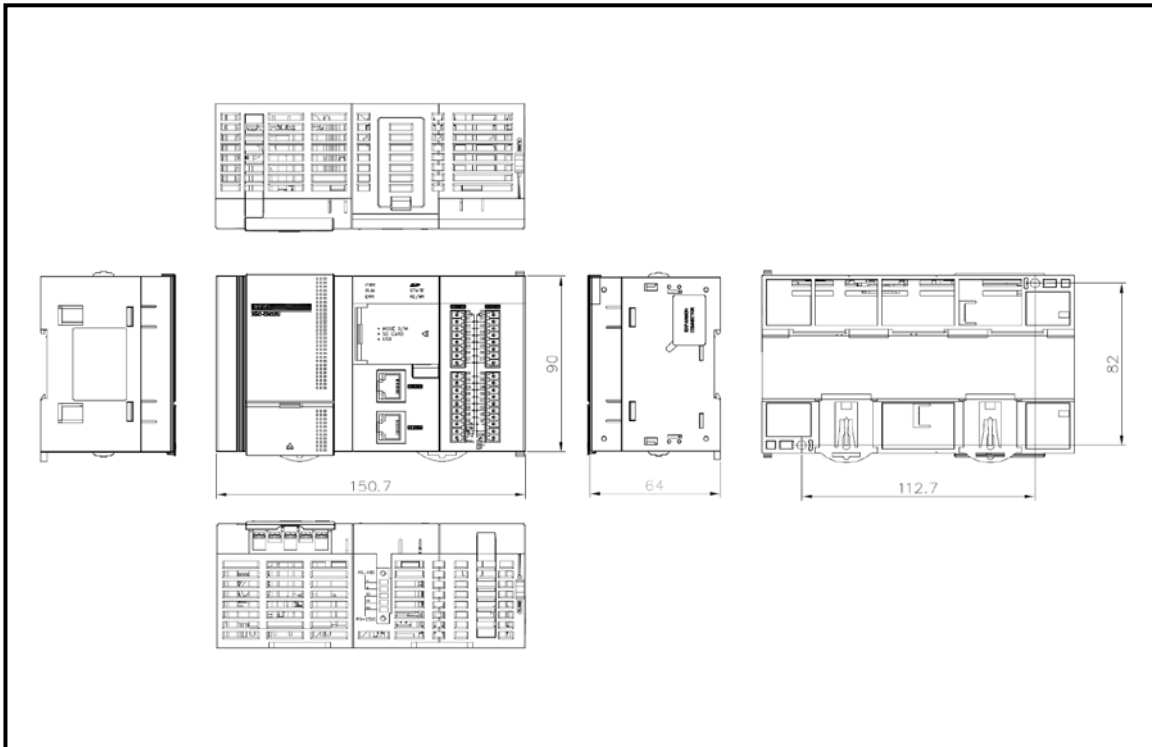

(2) Positioning Type

- XEC-DN32UP, XEC-DP32UP, XEC-DR28UP

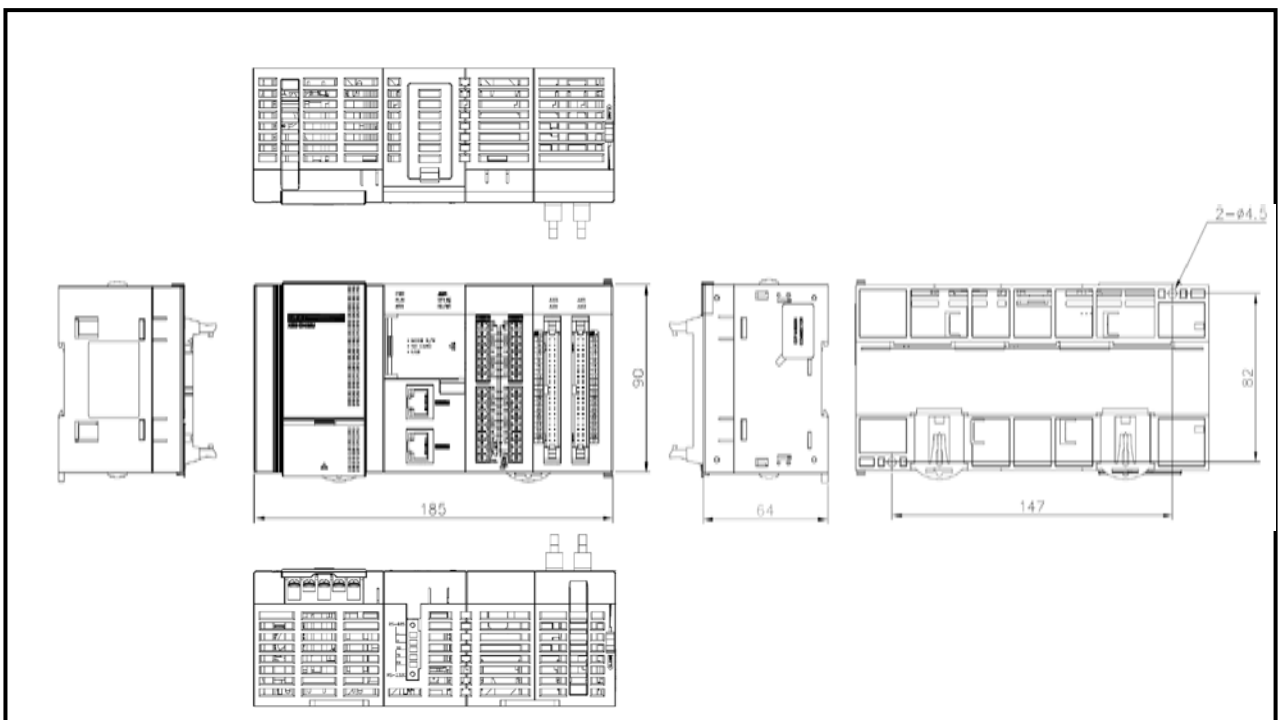

(2) Analog Type

- XEC-DN32UA, XEC-DP32UA, XEC-DR28UA

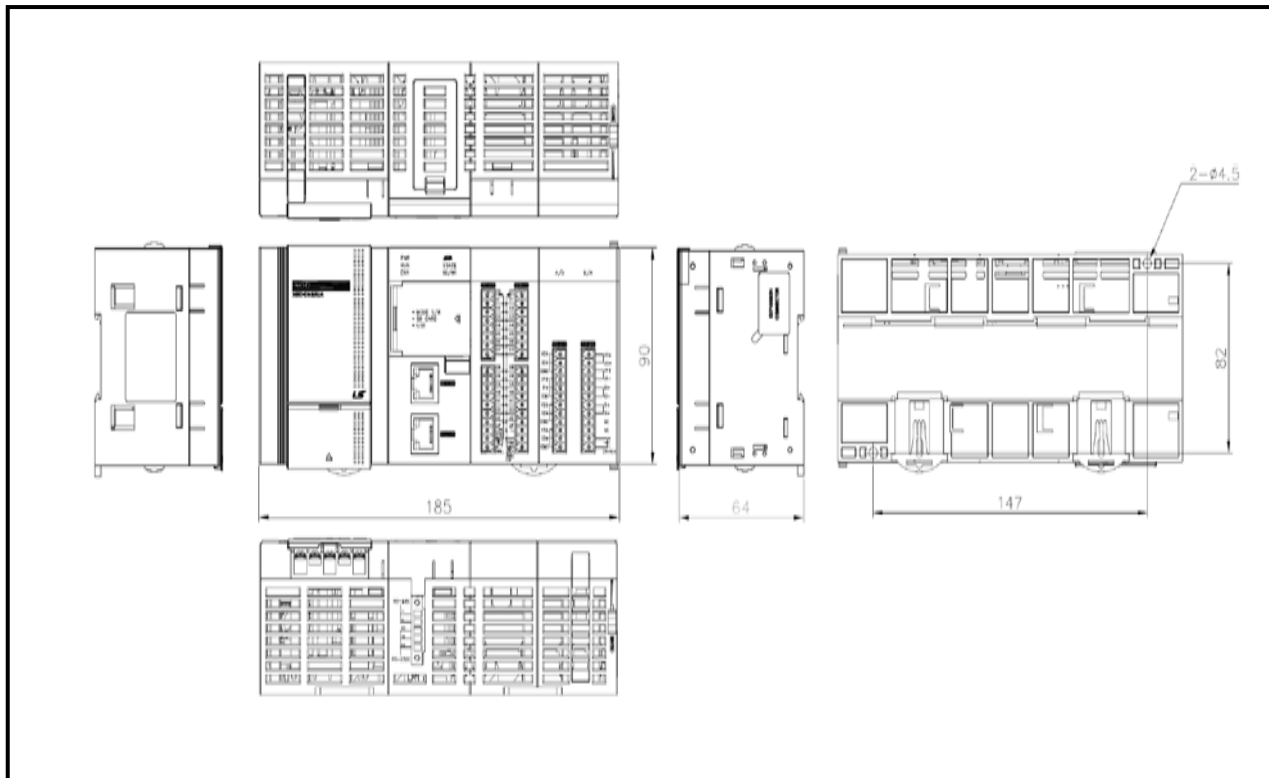

(3) Extension I/O module

- XBE-DC32A, XBE-TR32A

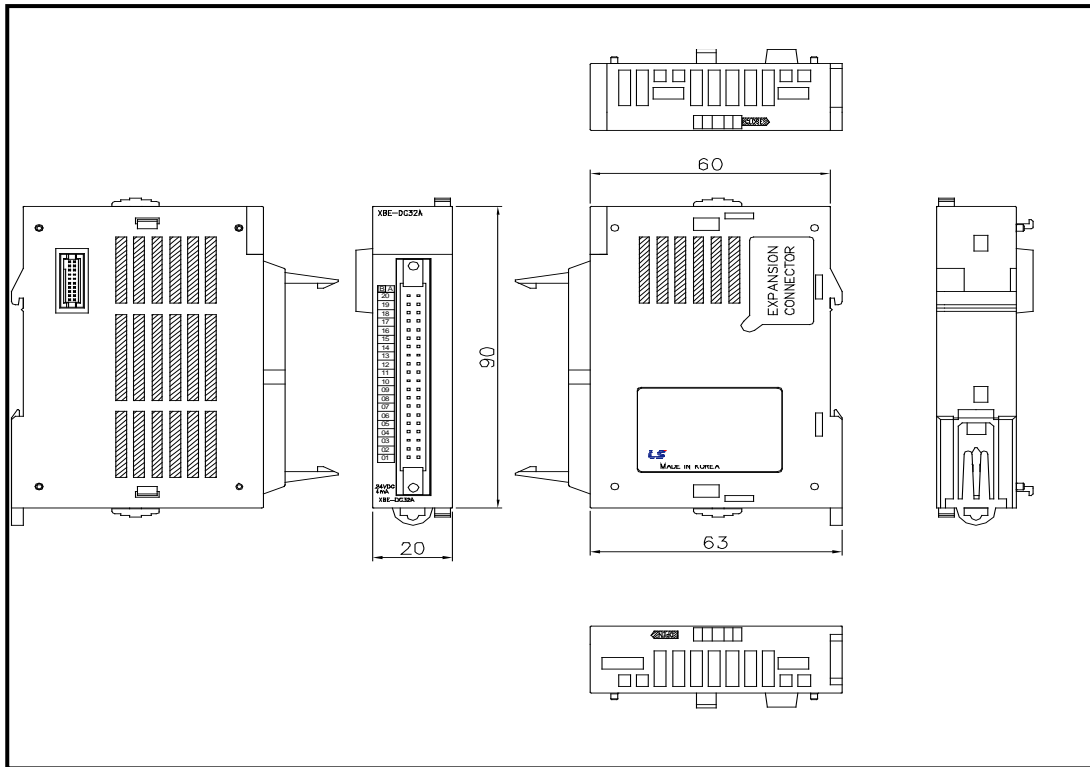

- XBE-RY16A

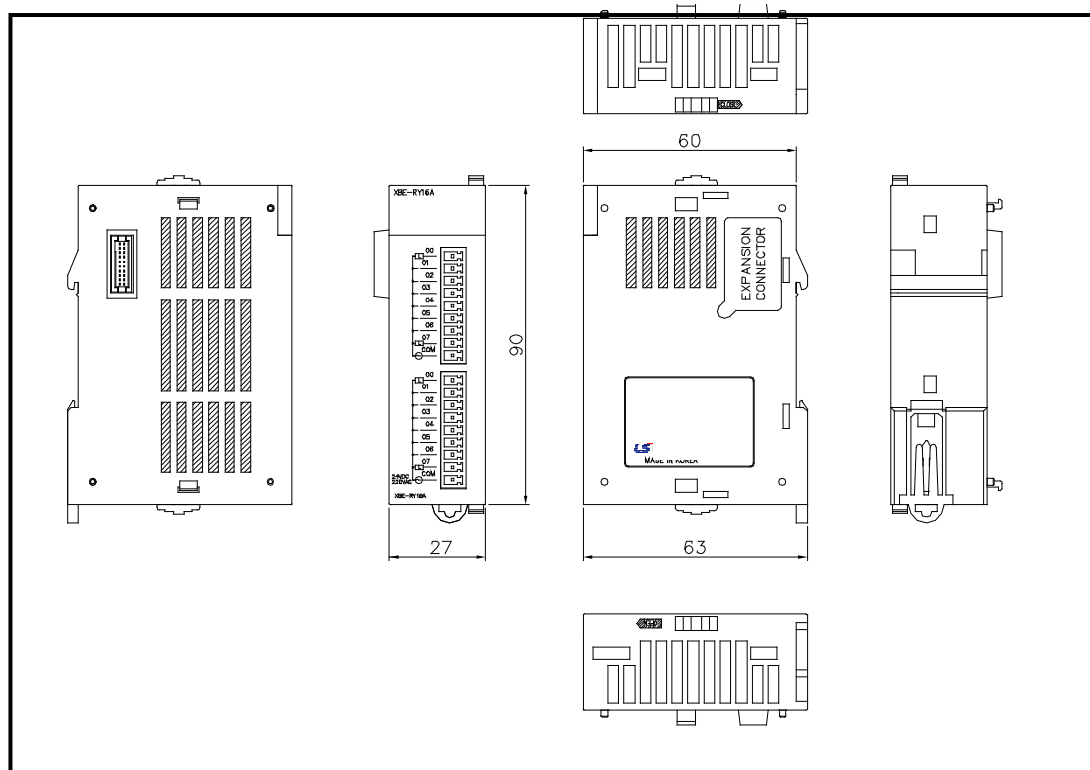

- XBE-DC08A, XBE-DC16A, XBE-TN08A, XBE-TN16A

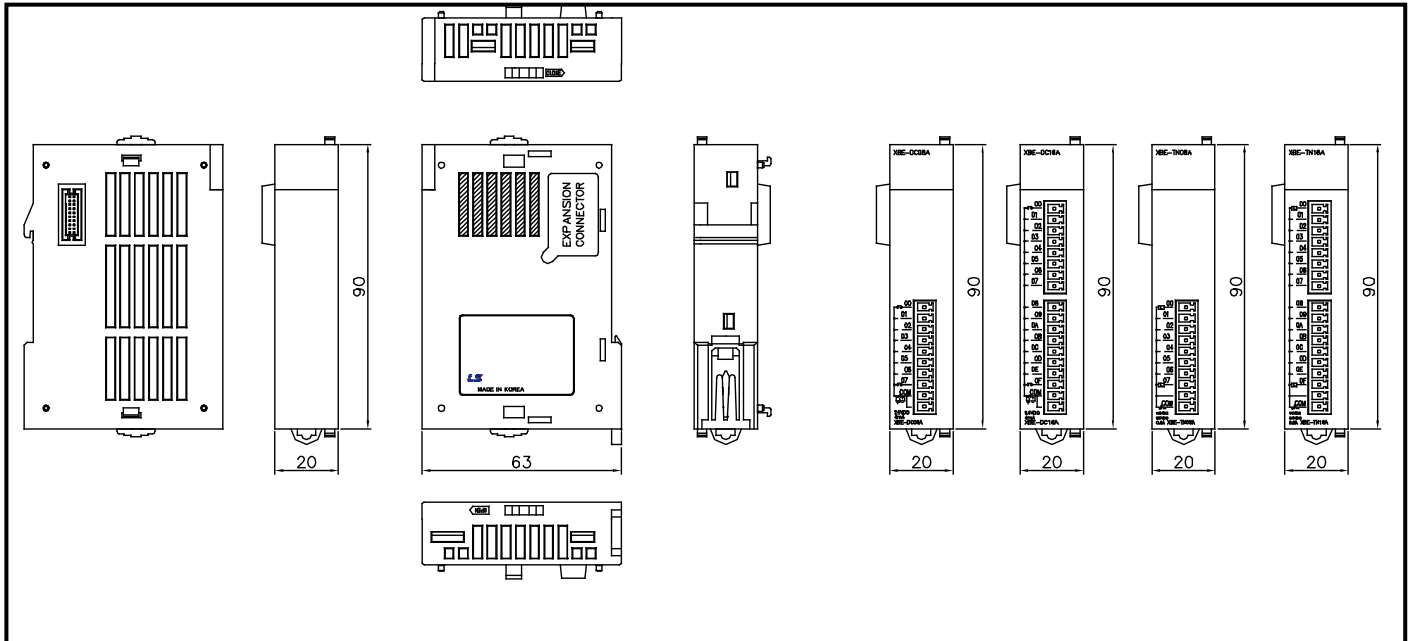

- XBE-DR16A, XBE-RY08A

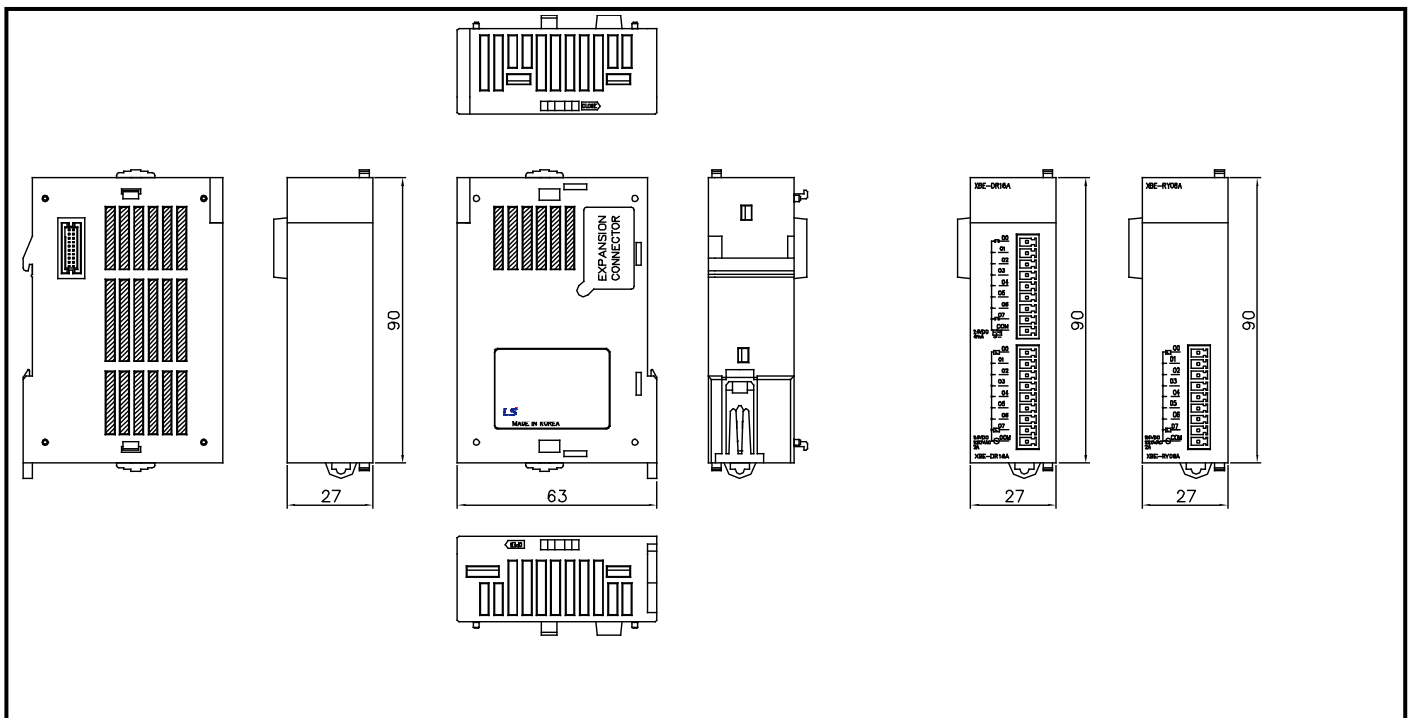

(4) Extension Cnet I/F Module

. XBL-C41A, XBL-C21A

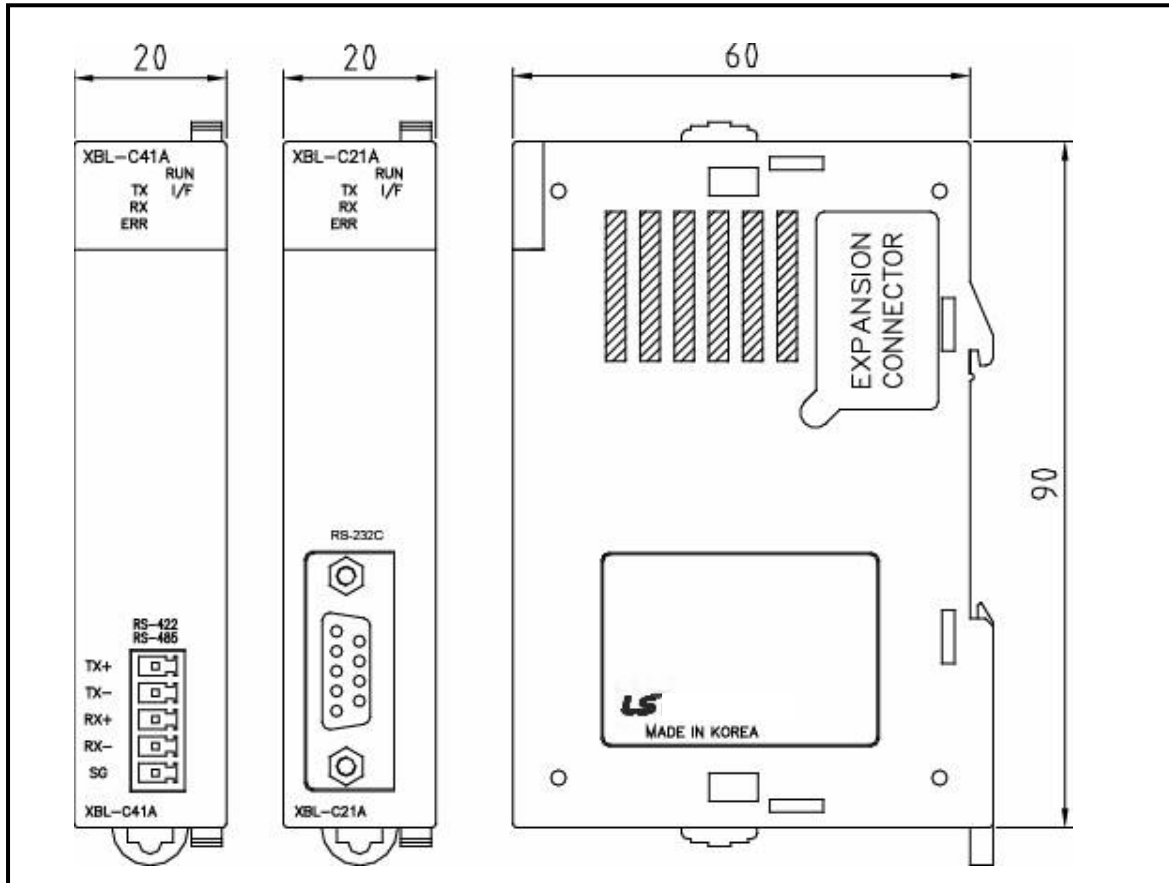

Appendix 3 Instruction List

It's a list of function and function block. For each function and function block, please refer to XGI/XGR/XEC Instruction user manual.

Appendix 3.1 Basic Function

Appendix 3.1.1 Type Conversion Function

It converts each input data type into an output data type.

Function Group	Function	Input data type	Output data type	Remarks
ARY_ASC_TO_***	ARY_ASC_TO_BYTE	WORD(ASCII)	BYTE	
	ARY_ASC_TO_BCD	WORD(ASCII)	BYTE(BCD)	
ARY_BYTE_TO_***	ARY_BYTE_TO_ASC	BYTE	WORD(ASCII)	
ARY_BCD_TO_***	ARY_BCD_TO_ASC	BYTE(BCD)	WORD(ASCII)	
ASC_TO_***	ASC_TO_BCD	BYTE(BCD)	USINT	
	ASC_TO_BYTE	WORD(BCD)	UINT	
BCD_TO_***	BYTE_BCD_TO_SINT	BYTE(BCD)	SINT	
	WORD_BCD_TO_INT	WORD(BCD)	INT	
	DWORD_BCD_TO_DINT	DWORD(BCD)	DINT	
	LWORD_BCD_TO_LINT	LWORD(BCD)	LINT	
	BYTE_BCD_TO_USINT	BYTE(BCD)	USINT	
	WORD_BCD_TO_UINT	WORD(BCD)	UINT	
	DWORD_BCD_TO_UDINT	DWORD(BCD)	UDINT	
	LWORD_BCD_TO_ULINT	LWORD(BCD)	ULINT	
BCD_TO_ASC	BCD_TO_ASC	BYTE(BCD)	WORD	
BYTE_TO_ASC	BYTE_TO_ASC	BYTE	ASC(BYTE)	
TRUNC	TRUNC_REAL	REAL	DINT	
	TRUNC_LREAL	LREAL	LINT	
REAL_TO_***	REAL_TO_SINT	REAL	SINT	
	REAL_TO_INT	REAL	INT	
	REAL_TO_DINT	REAL	DINT	
	REAL_TO_LINT	REAL	LINT	
	REAL_TO_USINT	REAL	USINT	
	REAL_TO_UINT	REAL	UINT	
	REAL_TO_UDINT	REAL	UDINT	
	REAL_TO_ULINT	REAL	ULINT	
	REAL_TO_DWORD	REAL	DWORD	
	REAL_TO_LREAL	REAL	LREAL	
	REAL_TO_STRING	REAL	STRING	
LREAL_TO_***	LREAL_TO_SINT	LREAL	SINT	
	LREAL_TO_INT	LREAL	INT	
	LREAL_TO_DINT	LREAL	DINT	
	LREAL_TO_LINT	LREAL	LINT	
	LREAL_TO_USINT	LREAL	USINT	
LREAL_TO_***	LREAL_TO_UINT	LREAL	UINT	
	LREAL_TO_UDINT	LREAL	UDINT	
	LREAL_TO_ULINT	LREAL	ULINT	
	LREAL_TO_LWORD	LREAL	LWORD	
	LREAL_TO_REAL	LREAL	REAL	
	LREAL_TO_STRING	LREAL	STRING	

Function Group	Function	Input data type	Output data type	Remarks
SINT_TO_***	SINT_TO_INT	SINT	INT	
	SINT_TO_DINT	SINT	DINT	
	SINT_TO_LINT	SINT	LINT	
	SINT_TO_USINT	SINT	USINT	
	SINT_TO_UINT	SINT	UINT	
	SINT_TO_UDINT	SINT	UDINT	
	SINT_TO_ULINT	SINT	ULINT	
	SINT_TO_BOOL	SINT	BOOL	
	SINT_TO_BYTE	SINT	BYTE	
	SINT_TO_WORD	SINT	WORD	
	SINT_TO_DWORD	SINT	DWORD	
	SINT_TO_LWORD	SINT	LWORD	
	SINT_TO_REAL	SINT	REAL	
	SINT_TO_LREAL	SINT	LREAL	
	SINT_TO_STRING	SINT	STRING	
INT_TO_***	INT_TO_SINT	INT	SINT	
	INT_TO_DINT	INT	DINT	
	INT_TO_LINT	INT	LINT	
	INT_TO_USINT	INT	USINT	
	INT_TO_UINT	INT	UINT	
	INT_TO_UDINT	INT	UDINT	
	INT_TO_ULINT	INT	ULINT	
	INT_TO_BOOL	INT	BOOL	
	INT_TO_BYTE	INT	BYTE	
	INT_TO_WORD	INT	WORD	
	INT_TO_DWORD	INT	DWORD	
	INT_TO_LWORD	INT	LWORD	
	INT_TO_REAL	INT	REAL	
	INT_TO_LREAL	INT	LREAL	
	INT_TO_STRING	INT	STRING	
DINT_TO_***	DINT_TO_SINT	DINT	SINT	
	DINT_TO_INT	DINT	INT	
	DINT_TO_LINT	DINT	LINT	
	DINT_TO_USINT	DINT	USINT	
	DINT_TO_UINT	DINT	UINT	
	DINT_TO_UDINT	DINT	UDINT	
	DINT_TO_ULINT	DINT	ULINT	
	DINT_TO_BOOL	DINT	BOOL	
	DINT_TO_BYTE	DINT	BYTE	
	DINT_TO_WORD	DINT	WORD	
DINT_TO_***	DINT_TO_DWORD	DINT	DWORD	
	DINT_TO_LWORD	DINT	LWORD	
	DINT_TO_REAL	DINT	REAL	
	DINT_TO_LREAL	DINT	LREAL	
	DINT_TO_STRING	DINT	STRING	
LINT_TO_***	LINT_TO_SINT	LINT	SINT	
	LINT_TO_INT	LINT	INT	
	LINT_TO_DINT	LINT	DINT	
	LINT_TO_USINT	LINT	USINT	
	LINT_TO_UINT	LINT	UINT	
	LINT_TO_UDINT	LINT	UDINT	
	LINT_TO_ULINT	LINT	ULINT	
	LINT_TO_BOOL	LINT	BOOL	
	LINT_TO_BYTE	LINT	BYTE	
	LINT_TO_WORD	LINT	WORD	
LINT_TO_DWORD	LINT	DWORD		

Function Group	Function	Input data type	Output data type	Remarks
LINT_TO_***	LINT_TO_LWORD	LINT	LWORD	
	LINT_TO_REAL	LINT	REAL	
	LINT_TO_LREAL	LINT	LREAL	
	LINT_TO_STRING	LINT	STRING	
USINT_TO_***	USINT_TO_SINT	USINT	SINT	
	USINT_TO_INT	USINT	INT	
	USINT_TO_DINT	USINT	DINT	
	USINT_TO_LINT	USINT	LINT	
	USINT_TO_UINT	USINT	UINT	
	USINT_TO_UDINT	USINT	UDINT	
	USINT_TO_ULINT	USINT	ULINT	
	USINT_TO_BOOL	USINT	BOOL	
	USINT_TO_BYTE	USINT	BYTE	
	USINT_TO_WORD	USINT	WORD	
	USINT_TO_DWORD	USINT	DWORD	
	USINT_TO_LWORD	USINT	LWORD	
	USINT_TO_REAL	USINT	REAL	
	USINT_TO_LREAL	USINT	LREAL	
	USINT_TO_STRING	USINT	STRING	
	UINT_TO_***	UINT_TO_SINT	UINT	SINT
UINT_TO_INT		UINT	INT	
UINT_TO_DINT		UINT	DINT	
UINT_TO_LINT		UINT	LINT	
UINT_TO_USINT		UINT	USINT	
UINT_TO_UDINT		UINT	UDINT	
UINT_TO_ULINT		UINT	ULINT	
UINT_TO_BOOL		UINT	BOOL	
UINT_TO_BYTE		UINT	BYTE	
UINT_TO_WORD		UINT	WORD	
UINT_TO_DWORD		UINT	DWORD	
UINT_TO_***	UINT_TO_LWORD	UINT	LWORD	
	UINT_TO_REAL	UINT	REAL	
	UINT_TO_STRING	UINT	STRING	
	UINT_TO_LREAL	UINT	LREAL	
UDINT_TO_***	UDINT_TO_SINT	UDINT	SINT	
	UDINT_TO_INT	UDINT	INT	
	UDINT_TO_DINT	UDINT	DINT	
	UDINT_TO_LINT	UDINT	LINT	
	UDINT_TO_USINT	UDINT	USINT	
	UDINT_TO_UINT	UDINT	UINT	
	UDINT_TO_ULINT	UDINT	ULINT	
	UDINT_TO_BOOL	UDINT	BOOL	
	UDINT_TO_BYTE	UDINT	BYTE	
	UDINT_TO_WORD	UDINT	WORD	
	UDINT_TO_DWORD	UDINT	DWORD	
	UDINT_TO_LWORD	UDINT	LWORD	
	UDINT_TO_REAL	UDINT	REAL	
	UDINT_TO_LREAL	UDINT	LREAL	-
	UDINT_TO_TOD	UDINT	TOD	-
	UDINT_TO_TIME	UDINT	TIME	-
	UDINT_TO_STRING	UDINT	STRING	-
ULINT_TO_***	ULINT_TO_SINT	ULINT	SINT	-
	ULINT_TO_INT	ULINT	INT	-
	ULINT_TO_DINT	ULINT	DINT	-
	ULINT_TO_LINT	ULINT	LINT	-

Function Group	Function	Input data type	Output data type	Remarks
ULINT_TO_***	ULINT_TO_USINT	ULINT	USINT	-
	ULINT_TO_UINT	ULINT	UINT	
	ULINT_TO_UDINT	ULINT	UDINT	
	ULINT_TO_BOOL	ULINT	BOOL	
	ULINT_TO_BYTE	ULINT	BYTE	
	ULINT_TO_WORD	ULINT	WORD	
	ULINT_TO_DWORD	ULINT	DWORD	-
	ULINT_TO_LWORD	ULINT	LWORD	-
	ULINT_TO_REAL	ULINT	REAL	-
	ULINT_TO_LREAL	ULINT	LREAL	-
	ULINT_TO_STRING	ULINT	STRING	-
BOOL_TO_***	BOOL_TO_SINT	BOOL	SINT	-
	BOOL_TO_INT	BOOL	INT	-
	BOOL_TO_DINT	BOOL	DINT	-
	BOOL_TO_LINT	BOOL	LINT	-
	BOOL_TO_USINT	BOOL	USINT	-
	BOOL_TO_UINT	BOOL	UINT	-
	BOOL_TO_UDINT	BOOL	UDINT	-
	BOOL_TO_ULINT	BOOL	ULINT	-
	BOOL_TO_BYTE	BOOL	BYTE	-
BOOL_TO_***	BOOL_TO_WORD	BOOL	WORD	-
	BOOL_TO_DWORD	BOOL	DWORD	-
	BOOL_TO_LWORD	BOOL	LWORD	-
	BOOL_TO_STRING	BOOL	STRING	-
BYTE_TO_***	BYTE_TO_SINT	BYTE	SINT	-
	BYTE_TO_INT	BYTE	INT	-
	BYTE_TO_DINT	BYTE	DINT	-
	BYTE_TO_LINT	BYTE	LINT	-
	BYTE_TO_USINT	BYTE	USINT	-
	BYTE_TO_UINT	BYTE	UINT	-
	BYTE_TO_UDINT	BYTE	UDINT	-
	BYTE_TO_ULINT	BYTE	ULINT	-
	BYTE_TO_BOOL	BYTE	BOOL	-
	BYTE_TO_WORD	BYTE	WORD	-
	BYTE_TO_DWORD	BYTE	DWORD	-
	BYTE_TO_LWORD	BYTE	LWORD	-
BYTE_TO_STRING	BYTE	STRING	-	
WORD_TO_***	WORD_TO_SINT	WORD	SINT	-
	WORD_TO_INT	WORD	INT	-
	WORD_TO_DINT	WORD	DINT	-
	WORD_TO_LINT	WORD	LINT	-
	WORD_TO_USINT	WORD	USINT	-
	WORD_TO_UINT	WORD	UINT	-
	WORD_TO_UDINT	WORD	UDINT	-
	WORD_TO_ULINT	WORD	ULINT	-
	WORD_TO_BOOL	WORD	BOOL	-
	WORD_TO_BYTE	WORD	BYTE	-
	WORD_TO_DWORD	WORD	DWORD	-
	WORD_TO_LWORD	WORD	LWORD	-
	WORD_TO_DATE	WORD	DATE	-
	WORD_TO_STRING	WORD	STRING	-
DWORD_TO_***	DWORD_TO_SINT	DWORD	SINT	
	DWORD_TO_INT	DWORD	INT	
	DWORD_TO_DINT	DWORD	DINT	
	DWORD_TO_LINT	DWORD	LINT	
	DWORD_TO_USINT	DWORD	USINT	
	DWORD_TO_UINT	DWORD	UINT	

Appendix3 Instruction List

Function Group	Function	Input data type	Output data type	Remarks
DWORD_TO_**	DWORD_TO_UDINT	DWORD	UDINT	
	DWORD_TO_ULINT	DWORD	ULINT	
	DWORD_TO_BOOL	DWORD	BOOL	
	DWORD_TO_BYTE	DWORD	BYTE	
	DWORD_TO_WORD	DWORD	WORD	
	DWORD_TO_LWORD	DWORD	LWORD	
	DWORD_TO_REAL	DWORD	REAL	
	DWORD_TO_TIME	DWORD	TIME	
	DWORD_TO_TOD	DWORD	TOD	
	DWORD_TO_STRING	DWORD	STRING	
LWORD_TO_***	LWORD_TO_SINT	LWORD	SINT	
	LWORD_TO_INT	LWORD	INT	
	LWORD_TO_DINT	LWORD	DINT	
	LWORD_TO_LINT	LWORD	LINT	
	LWORD_TO_USINT	LWORD	USINT	
	LWORD_TO_UINT	LWORD	UINT	
	LWORD_TO_UDINT	LWORD	UDINT	
	LWORD_TO_ULINT	LWORD	ULINT	
	LWORD_TO_BOOL	LWORD	BOOL	
	LWORD_TO_BYTE	LWORD	BYTE	
	LWORD_TO_WORD	LWORD	WORD	
	LWORD_TO_DWORD	LWORD	DWORD	
	LWORD_TO_LREAL	LWORD	LREAL	
	LWORD_TO_DT	LWORD	DT	
LWORD_TO_STRING	LWORD	STRING		
STRING_TO_***	STRING_TO_SINT	STRING	SINT	
	STRING_TO_INT	STRING	INT	
	STRING_TO_DINT	STRING	DINT	
	STRING_TO_LINT	STRING	LINT	
	STRING_TO_USINT	STRING	USINT	
	STRING_TO_UINT	STRING	UINT	
	STRING_TO_UDINT	STRING	UDINT	
	STRING_TO_ULINT	STRING	ULINT	
	STRING_TO_BOOL	STRING	BOOL	
	STRING_TO_BYTE	STRING	BYTE	
	STRING_TO_WORD	STRING	WORD	
	STRING_TO_DWORD	STRING	DWORD	
	STRING_TO_LWORD	STRING	LWORD	
	STRING_TO_REAL	STRING	REAL	
	STRING_TO_LREAL	STRING	LREAL	
	STRING_TO_DT	STRING	DT	
STRING_TO_DATE	STRING	DATE		
STRING_TO_TOD	STRING	TOD		
STRING_TO_TIME	STRING	TIME		
TIME_TO_***	TIME_TO_UDINT	TIME	UDINT	
	TIME_TO_DWORD	TIME	DWORD	
	TIME_TO_STRING	TIME	STRING	
DATE_TO_***	DATE_TO_UINT	DATE	UINT	
	DATE_TO_WORD	DATE	WORD	
	DATE_TO_STRING	DATE	STRING	
TOD_TO_***	TOD_TO_UDINT	TOD	UDINT	
	TOD_TO_DWORD	TOD	DWORD	
	TOD_TO_STRING	TOD	STRING	
DT_TO_***	DT_TO_LWORD	DT	LWORD	
	DT_TO_DATE	DT	DATE	
	DT_TO_TOD	DT	TOD	
	DT_TO_STRING	DT	STRING	

Function Group	Function	Input data type	Output data type	Remarks
***_TO_BCD	SINT_TO_BCD_BYTE	SINT	BYTE(BCD)	
	INT_TO_BCD_WORD	INT	WORD(BCD)	
	DINT_TO_BCD_DWORD	DINT	DWORD(BCD)	
	LINT_TO_BCD_LWORD	LINT	LWORD(BCD)	
	USINT_TO_BCD_BYTE	USINT	BYTE(BCD)	
	UINT_TO_BCD_WORD	UINT	WORD(BCD)	
	UDINT_TO_BCD_DWORD	UDINT	DWORD(BCD)	
	ULINT_TO_BCD_LWORD	ULINT	LWORD(BCD)	

Appendix 3.1.2 Numerical Operation Function

(1) Numerical Operation Function with One Input

No.	Function name	Description	Remarks
General Function			
1	ABS	Absolute value operation	
2	SQRT	Square root operation	
Log function			
3	LN	Natural logarithm operation	
4	LOG	Common logarithm Base to 10 operation	
5	EXP	Natural exponential operation	
Trigonometric function			
6	SIN	Sine operation	
7	COS	Cosine operation	
8	TAN	Tangent operation	
9	ASIN	Arc sine operation	
10	ACOS	Arc Cosine operation	
11	ATAN	Arc Tangent operation	
Angle function			
12	RAD_REAL	Convert degree into radian	
13	RAD_LREAL		
14	DEG_REAL	Convert radian into degree	
15	DEG_LREAL		

(2) Basic Arithmetic Function

No.	Function name	Description	Remarks
Operation function of which input number (n) can be extended up to 8.			
1	ADD	Addition (OUT <= IN1 + IN2 + ... + INn)	
2	MUL	Multiplication (OUT <= IN1 * IN2 * ... * INn)	
Operation function of which input number is fixed.			
3	SUB	Subtraction (OUT <= IN1 - IN2)	
4	DIV	Division (OUT <= IN1 / IN2)	
5	MOD	Calculate remainder (OUT <= IN1 Modulo IN2)	
6	EXPT	Exponential operation (OUT <= IN1 ^{IN2})	
7	MOVE	Copy data (OUT <= IN)	
Input data exchange			
8	XCHG_***	Exchanges two input data	

Appendix 3.1.3 Bit Array Function

(1) Bit-shift Function

No.	Function name	Description	Remarks
1	SHL	Shift input to the left of N bit(the right is filled with 0)	
2	SHR	Shift input to the right of N bit (the left is filled with 0)	
3	SHIFT_C_***	Shift input to the designated direction as much as N bit (carry)	
4	ROL	Rotate input to the left of N bit	
5	ROR	Rotate input to the right of N bit	
6	ROTATE_C_***	Rotate input to the direction as much as N bit (carry)	

(2) Bit Operation Function

No.	Function name	Description (n can be extended up to 8)	Remarks
1	AND	Logical AND (OUT <= IN1 AND IN2 AND ... AND INn)	
2	OR	Logical OR (OUT <= IN1 OR IN2 OR ... OR INn)	
3	XOR	Exclusive OR (OUT <= IN1 XOR IN2 XOR ... XOR INn)	
4	NOT	Reverse logic (OUT <= NOT IN1)	
5	XNR	Exclusive logic AND (OUT <= IN1 XNR IN2 XNR ... XNR INn)	

Appendix 3.1.4 Selection Function

No.	Function name	Description(n can be extended up to 8)	Remarks
1	SEL	Selects from two inputs (IN0 or IN1)	
2	MAX	Produces the maximum value among input IN1,...INn	
3	MIN	Produces the minimum value among input IN1,...INn	
4	LIMIT	Limits upper and lower boundaries	
5	MUX	Outputs the K-th input among input IN1,...INn	

Appendix 3.1.5 Data Exchange Function

No.	Function name	Description	Remarks
1	SWAP_BYTE	Swaps upper NIBBLE for lower NIBBLE data of BYTE.	
	SWAP_WORD	Swaps upper BYTE for lower BYTE data of WORD.	
	SWAP_DWORD	Swaps upper WORD for lower WORD data DWORD.	
	SWAP_LWORD	Swaps upper DWORD for lower DWORD data of LWORD.	
2	ARY_SWAP_BYTE	Swaps upper/lower NIBBLE of BYTE elements in array.	
	ARY_SWAP_WORD	Swaps upper/lower BYTE of WORD elements in array.	
	ARY_SWAP_DWORD	Swaps upper/lower WORD of DWORD elements in array.	
	ARY_SWAP_LWORD	Swaps upper/lower DWORD of LWORD elements in array.	

Appendix 3.1.6 Comparison Function

No.	Function name	Description (n can be extended up to 8)	Remarks
1	GT	'Greater than' comparison OUT <= (IN1>IN2) & (IN2>IN3) & ... & (INn-1 > INn)	
2	GE	'Greater than or equal to' comparison OUT <= (IN1>=IN2) & (IN2>=IN3) & ... & (INn-1 >= INn)	
3	EQ	'Equal to' comparison OUT <= (IN1=IN2) & (IN2=IN3) & ... & (INn-1 = INn)	
4	LE	'Less than or equal to' comparison OUT <= (IN1<=IN2) & (IN2<=IN3) & ... & (INn-1 <= INn)	
5	LT	'Less than' comparison OUT <= (IN1<IN2) & (IN2<IN3) & ... & (INn-1 < INn)	
6	NE	'Not equal to' comparison OUT <= (IN1<>IN2) & (IN2<>IN3) & ... & (INn-1 <> INn)	

Appendix 3.1.7 Character String Function

No.	Function name	Description	Remarks
1	LEN	Find a length of a character string	
2	LEFT	Take a left side of a string (size of L) and output it	
3	RIGHT	Take a right side of a string (size of L) and output it	
4	MID	Take a middle side of a string (size of L from the P-th character)	
5	CONCAT	Concatenate the input character string in order	
6	INSERT	Insert the second string after the P-th character of the first string	
7	DELETE	Delete a string (size of L from the P-th character)	
8	REPLACE	Replace a size of L from the P-th character of the first string by the second string	
9	FIND	Find a starting point of the first string which has a same pattern of the second string.	

Appendix 3.1.8 Date and Time of Day Function

No.	Function name	Description	Remarks
1	ADD_TIME	Add time (Time/time of day/date and time addition)	
2	SUB_TIME	Subtract time (Time/time of day/date and time subtraction)	
	SUB_DATE	Calculate time by subtracting date from date	
	SUB_TOD	Calculate time by subtracting TOD from TOD	
	SUB_DT	Calculate time by subtracting DT from DT	
	MUL_TIME	Multiply number to time	
4	DIV_TIME	Divide time by number	
5	CONCAT_TIME	Concatenate date to make TOD	

Appendix 3.1.9 System Control Function

No.	Function name	Description	Remarks
1	DI	Invalidates interrupt (Not to permit task program starting)	
2	EI	Permits running for a task program	
3	STOP	Stop running by a task program	
4	ESTOP	Emergency running stop by a program	
5	DIREC_IN	Update input data	
6	DIREC_O	Updates output data	
7	WDT_RST	Initialize a timer of watchdog	
8	MCS	Master Control	
9	MCSCLR	Master Control Clear	
10	FALS	Self check(error display)	
11	OUTOFF	Output Off	

Appendix 3.1.10 File Function

No.	Function block name	Description	Remarks
1	RSET	Setting file register block number	
2	EBCMP	Block comparison	
3	EMOV	Reading data from the preset flash area	
4	EERRST	Flash memory related error flag clear	

Appendix 3.1.11 Data Manipulation Function

No.	Function name	Description	Remarks
1	MEQ_***	Compare whether two inputs are equal after masking	
2	DIS_***	Data distribution	
3	UNI_***	Unite data	
4	BIT_BYTE	Combine 8 bits into one BYTE	
5	BYTE_BIT	Divide one BYTE into 8 bits	
6	BYTE_WORD	Combine two bytes into one WORD	
7	WORD_BYTE	Divide one WORD into two bytes	
8	WORD_DWORD	Combine two WORD data into DWORD	
9	DWORD_WORD	Divide DWORD into 2 WORD data	
10	DWORD_LWORD	Combine two DWORD data into LWORD	
11	LWORD_DWORD	Divide LWORD into two DWORD data	
12	GET_CHAR	Get one character from a character string	
13	PUT_CHAR	Puts a character in a string	
14	STRING_BYTE	Convert a string into a byte array	
15	BYTE_STRING	Convert a byte array into a string	

Appendix 3.1.12 Stack Operation Function

No.	Function name	Description	Remarks
1	FIFO_***	First In First Out	
2	LIFO_***	Last In First Out	

Appendix 3.2 MK(MASTER-K) Function

No.	Function name	Description(n can be extended up to 8)	Remarks
1	ENCO_B,W,D,L	Output a position of On bit by number	
2	DECO_B,W,D,L	Turn a selected bit on	
3	BSUM_B,W,D,L	Output a number of On bit	
4	SEG_WORD	Convert BCD/HEX into 7-segment code	
5	BMOV_B,W,D,L	Move part of a bit string	
6	INC_B,W,D,L	Increase IN data	
7	DEC_B,W,D,L	Decrease IN data	

Appendix 3.3 Array Operation Function

No.	Function name	Description	Remarks
1	ARY_MOVE	Copy array-typed data (OUT <= IN)	
2	ARY_CMP_***	Array comparison	
3	ARY_SCH_***	Array search	
4	ARY_FLL_***	Filling an array with data	
5	ARY_AVE_***	Find an average of an array	
6	ARY_SFT_C_***	Array bit shift left with carry	
7	ARY_ROT_C_***	Bit rotation of array with carry	
8	SHIFT_A_***	Shift array elements	
9	ROTATE_A_***	Rotates array elements	

Appendix 3.4 Basic Function Block

Appendix 3.4.1 Bistable Function Block

No.	Function block name	Description	Remarks
1	SR	Set preference bistable	
2	RS	Reset preference bistable	
3	SEMA	Semaphore	

Appendix 3.4.2 Edge Detection Function Block

No.	Function block name	Description	Remarks
1	R_TRIG	Rising edge detector	
2	F_TRIG	Falling edge detector	
3	FF	Reverse output if input condition rises	

Appendix 3.4.3 Counter

No.	Function block name	Description	Remarks
1	CTU_***	Up Counter INT,DINT,LINT,UINT,UDINT,ULINT	
2	CTD_***	Down Counter INT,DINT,LINT,UINT,UDINT,ULINT	
3	CTUD_***	Up Down Counter INT,DINT,LINT,UINT,UDINT,ULINT	
4	CTR	Ring Counter	

Appendix 3.4.4 Timer

No.	Function block name	Description	Remarks
1	TP	Pulse Timer	
2	TON	On-Delay Timer	
3	TOF	Off-Delay Timer	
4	TMR	Integrating Timer	
5	TP_RST	TP with reset	
6	TRTG	Retriggerable Timer	
7	TOF_RST	TOF with reset	
8	TON_UINT	TON with integer setting	
9	TOF_UINT	TOF with integer setting	
10	TP_UINT	TP with integer setting	
11	TMR_UINT	TMR with integer setting	
12	TMR_FLK	Blink timer	
13	TRTG_UINT	Integer setting retriggerable timer	

Appendix 3.4.5 File Function Block

No.	Function block name	Description	Remarks
1	EBREAD	Read R area data from flash area	
2	EBWRITE	Write R area data to flash area	

Appendix 3.4.6 Other Function Block

No.	Function block name	Description	Remarks
1	SCON	Step Controller	
2	DUTY	Scan setting On/Off	
3	RTC_SET	Write time data	

Appendix 3.4.7 Special Function Block

No.	Function block name	Description	Remarks
1	GET	Read special module data	
2	PUT	Write special module data	
3	ARY_GET	Read special module data(array)	
4	ARY_PUT	Write special module data(array)	

Appendix 3.4.8 Positioning Function Block

No.	Function block name	Description	Remarks
1	APM_ORG	Return to original point run	
2	APM_FLT	Floating original point setting	
3	APM_DST	Direct run	
4	APM_IST	Indirect run	
5	APM_LIN	Linear interpolation run	
6	APM_SST	Simultaneous run	
7	APM_VTP	Speed/position control conversion	
8	APM_PTV	Position/speed control conversion	
9	APM_STP	Decelerating stop	
10	APM_SSP	Position synchronization	
11	APM_SSSB	Speed synchronization	
12	APM_POR	Position override	
13	APM_SOR	Speed override	
14	APM_PSO	Positioning speed override	
15	APM_INC	Inching run	
16	APM_SNS	Run step no. change	
17	APM_MOF	M code cancel	
18	APM_PRS	Present position preset	
19	APM_SIP	Input signal parameter setting	
20	APM_EMG	Emergency stop	
21	APM_RST	Error reset/output prohibition cancel	
22	APM_WRT	Saving parameter/run data	

No.	Function block name	Description	Remarks
1	XPM_ORG	Return to original point run	
2	XPM_FLT	Floating original point setting	
3	XPM_DST	Direct run	
4	XPM_IST	Indirect run	
5	XPM_SST	Simultaneous run	
6	XPM_VTP	Speed/position control conversion	
7	XPM_VTPP	Position specified Speed/Position Switching Control	
8	XPM_PTV	Position/speed control conversion	
9	XPM_STP	Decelerating stop	
10	XPM_SKP	Skip Operation	
11	XPM_SSP	Synchronous Start by Position	
12	XPM_SSS	Position synchronization	
13	XPM_SSSP	Speed synchronization	
14	XPM_POR	Position override	
15	XPM_SOR	Speed override	
16	XPM_PSO	Positioning speed override	
17	XPM_NMV	Continuous Operation	
18	XPM_INC	Inching run	
19	XPM_RTP	Return to the Previous Manual Operation Position	
20	XPM_SNS	Run step no. change	
21	XPM_SRS	Repeat Step No. Change	
22	XPM_MOF	M code cancel	
23	XPM_PRS	Present position preset	
24	XPM_EPRES	Encoder value preset	
25	XPM_ATEA	Teaching array	
26	XPM_SBP	Basic parameter teaching	
27	XPM_SEP	Extended parameter teaching	
28	XPM_SHP	Homing parameter teaching	

No.	Function block name	Description	Remarks
29	XPM_SMP	Manual operation parameter teaching	
30	XPM_SIP	Input signal parameter setting	
31	XPM_SCP	Common Parameter Setting	
32	XPM_SMD	peration Data Teaching	
33	XPM_VRD	Read Variable Data	
34	XPM_VWR	Write Variable Data	
35	XPM_EMG	Emergency stop	
36	XPM_RST	Error reset/output prohibition cancel	
37	XPM_HRST	Error History Reset	
38	XPM_PST	Point start	
39	XPM_WRT	Parameter/Operation Data Save	
40	XPM_CRD	Operation information read	
41	XPM_SRD	Operation state read	
42	XPM_ENCRD	Encoder value read	
43	XPM_JOG	JOG operation	
44	XPM_CAM	Cam Start	
45	XPM_CAMO	Main axis offset-specified CAM start	
46	XPM_ELIN	Circular Interpolation Operation	
47	XPM_RSTR	Restart	
48	XPM_SVON	Servo on	
49	XPM_SVOFF	Servo off	
50	XPM_SRST	Servo error reset	

Appendix 3.5 Expanded Function

No.	Function name	Description	Remarks
1	FOR	Repeat a block of FOR ~ NEXT n times	
2	NEXT		
3	BREAK	Escape a block of FOR ~ NEXT	
4	CALL	Call a SBRT routine	
5	SBRT	Assign a routine to be called by the CALL function	
6	RET	RETURN	
7	JMP	Jump to a place of LABEL	
8	INIT_DONE	Terminate an initial task	
9	END	Terminate a program	

Appendix 4 How to make the user page

The user page is one of the functions of the web server. A user can monitor and control the PLC remotely by making the web page personally. The following shows the way how to make the user web page with the sample code.

Appendix 4.1 Device monitoring parameter

To read or write the device data, you need to set up the device parameters. There are the device name, device type, display format for the device parameters. To make a user page, you need to be aware of the following three parameters.

Appendix 4.1.1 Device name

The device can be divided into MK language and IEC language. There are P, M, K, F, T, C, U, etc. for MK language devices and **there are I, Q, M, L, N, K, etc. for IEC language devices. You can set up the parameters by inputting the proper device name for the language supported by the product.**

1) XBC Series(MK type device)

The below table indicates the device data area of XBC series

Device	Start(Bit)	End(Bit)	Remarks
P	P0000(P00000)	P2047(P2047F)	Read, Write Enable
M	M0000(M00000)	M2047(M2047F)	Read, Write Enable
K	K0000(K00000)	K8191(K8191F)	Read, Write Enable
F	F0000(F00000)	F2047(F2047F)	Read Enable
T	T0000	T2047	Read, Write Enable
C	C0000	C2047	Read, Write Enable
U	U00.00(U00.00.0)	U0B.31(U0B.31.F)	Read, Write Enable
S	(S000.00)	(S127.99)	Read, Write Enable
Z	Z000	Z127	Read, Write Enable
L	L0000(L00000)	L4095(L4095F)	Read, Write Enable
N	N0000	N10239	Read Enable
D	D00000(D00000.0)	D19999(D19999.F)	Read, Write Enable
R	R00000(R00000.0)	R16383(R16383.F)	Read, Write Enable
ZR	ZR00000	ZR32767	Read, Write Enable

2) XEC Series(IEC type device)

The below table indicates the device data area of XEC series.

Device	Start	End	Remarks
I	%IX0.0.0	%IX15.15.63	Read, Write Enable
	%IB0.0.0	%IB15.15.7	Read, Write Enable
	%IW0.0.0	%IW15.15.3	Read, Write Enable
	%ID0.0.0	%ID15.15.1	Read, Write Enable
	%IL0.0.0	%IL15.15.0	Read, Write Enable
Q	%QX0.0.0	%QX15.15.63	Read, Write Enable
	%QB0.0.0	%QB15.15.7	Read, Write Enable
	%QW0.0.0	%QW15.15.3	Read, Write Enable
	%QD0.0.0	%QD15.15.1	Read, Write Enable
	%QL0.0.0	%QL15.15.0	Read, Write Enable
M	%MX0	%MX262143	Read, Write Enable
	%MB0	%MB32767	Read, Write Enable
	%MW0	%MW16383	Read, Write Enable
	%MD0	%MD8191	Read, Write Enable
	%ML0	%ML4095	Read, Write Enable
L	%LX0	%LX65535	Read, Write Enable
	%LB0	%LB8191	Read, Write Enable
	%LW0	%LW4095	Read, Write Enable
	%LD0	%LD2047	Read, Write Enable
	%LL0	%LL1023	Read, Write Enable
N	%NX0	%NX163839	Read Enable
	%NB0	%NB20479	Read Enable
	%NW0	%NW10239	Read Enable
	%ND0	%ND5119	Read Enable
	%NL0	%NL2559	Read Enable
K	%KX0	%KX131071	Read, Write Enable
	%KB0	%KB16383	Read, Write Enable
	%KW0	%KW8191	Read, Write Enable
	%KD0	%KD4095	Read, Write Enable
	%KL0	%KL2047	Read, Write Enable
U	%UX0.0.0	%UX0.11.511	Read, Write Enable
	%UB0.0.0	%UB0.11.63	Read, Write Enable
	%UW0.0.0	%UW0.11.31	Read, Write Enable
	%UD0.0.0	%UD0.11.15	Read, Write Enable
	%UL0.0.0	%UL0.11.7	Read, Write Enable
R	%RX0	%RX262143	Read, Write Enable
	%RB0	%RB32767	Read, Write Enable
	%RW0	%RW16383	Read, Write Enable
	%RD0	%RD8191	Read, Write Enable
	%RL0	%RL4095	Read, Write Enable

Device	Start	End	Remarks
A	%AX0	%AX524287	Read Enable
	%AB0	%AB65535	Read Enable
	%AW0	%AW32767	Read Enable
	%AD0	%AD16383	Read Enable
	%AL0	%AL8191	Read Enable
W	%WX0	%WX524287	Read, Write Enable
	%WB0	%WB65535	Read, Write Enable
	%WW0	%WW32767	Read, Write Enable
	%WD0	%WD16383	Read, Write Enable
	%WL0	%WL8191	Read, Write Enable
F	%FX0	%FX32767	Read Enable
	%FB0	%FB4095	Read Enable
	%FW0	%FW2047	Read Enable
	%FD0	%FD1023	Read Enable
	%FL0	%FL511	Read Enable

3) Device type

The device type is the parameter to change the device into various formats for the relevant types. The below table indicates the device type.

No.	Type	Size(Bit)	Available display format	Range [IEC]
0	SINT	8	Signed number decimal	-128 ~127
1	INT	16	Signed number decimal	-32768 ~32767
2	DINT	32	Signed number decimal	-2147483648 ~ 2147483647
3	LINT	64	Signed number decimal	-9223372036854775808 ~ 9223372036854775807
4	USINT	8	Unsigned number, decimal	0 ~ 255,
			Hexadecimal number	h00 ~ hFF[16#00 ~ 16#FF]
5	UINT	16	Unsigned number, decimal	0 ~ 65535,
			hexadecimal number	h0000 ~ hFFFF[16#0000 ~ 16#FFFF]
6	UDINT	32	Unsigned number, decimal	0 ~ 4294967295
			Hexadecimal number	h00000000 ~ hFFFFFFFF[16#00000000 ~ 16#FFFFFFFF]
7	ULINT	64	Unsigned number, decimal	0 ~ 18446744073709551615
			Hexadecimal number	h0000000000000000 ~ hFFFFFFFFFFFFFFFF [16#0000000000000000 ~ 16#FFFFFFFFFFFFFFFF]
8	REAL	32	Signed number, decimal	-3.402823466e+038 ~ -1.175494351e-038 or 0 or 1.175494351e-038 ~ 3.402823466e+038 (0 -> 0.000000000e+000)
9	LREAL	64	Signed number decimal	-1.7976931348623157e+308 ~ -2.2250738585072014e-308 or 0 or 2.2250738585072014e-308 ~ 1.7976931348623157e+308 (0 -> 0.0000000000000000e+000)
10	None	-	-	-
11	None	-	-	-
12	None	-	-	-
13	None	-	-	-
14	STRING	32*8	TEXT	'abcd GaNaDaRa 1234' (Korean 14자, 숫자 + English 31자)
15	BOOL	1	Unsigned number decimal	1,0(On, Off)
16	BYTE	8	Hexadecimal number	h00 ~ hFF[16#00 ~ 16#FF]
			Unsigned number decimal	0 ~ 255

No.	Type	Size(Bit)	Available display format	Range [IEC]
17	WORD	16	Hexadecimal number,	h0000 ~ hFFFF[16#0000 ~ 16#FFFF]
			Signed decimal number,	-32768 ~32767
			Unsigned decimal number	0 ~ 65535,
18	DWORD	32	Hexadecimal number,	h00000000 ~ hFFFFFFFF[16#00000000 ~ 16#FFFFFFFF]
			Signed decimal number	-2147483648 ~ 2147483647
			Unsigned decimal number	0 ~ 4294967295
19	LWORD	64	Hexadecimal number,	h0000000000000000 ~ hFFFFFFFFFFFFFFFF [16#0000000000000000 ~ 16#FFFFFFFFFFFFFFFF]
			Signed decimal number,	-9223372036854775808 ~ 9223372036854775807
			Unsigned decimal number	0 ~ 18446744073709551615

4) Display format

The display format is the parameter to express the device values as desired display formats. The below table indicates the display format of the device.

No.	Display format	Available type
0	Signed decimal number	SINT, INT, DINT, LINT, REAL, LREAL, WORD, DWORD, LWORD
1	Unsigned decimal number	USINT, UINT, UDINT, ULINT, BOOL, WORD, DWORD, LWORD
2	hexadecimal number	BYTE, WORD, DWORD, LWORD, USINT, UINT, UDINT, ULINT
3	TEXT	STRING
4	None	-

5) device monitoring parameter exercise

To read or write the device, you need to input the device name, device type, display format to the sample code. The following is the exercise related to device monitoring parameters to input to the sample code.

(1) XBC Series(MK language)

Device name	Device type	Display format	Range of values
M00000 (BIT access)	0 (SINT)	0 (Signed decimal number)	-128 ~ 127
M0000 (WORD access)	18 (DWORD)	2 (hexadecimal number)	h00000000 ~ hFFFFFFFF
D00000.F (BIT access)	15 (BOOL)	1 (Unsigned decimal number)	0, 1
D00100 (WORD access)	2 (DINT)	2 (Signed decimal number)	-2147483648 ~ 2147483647

(2) XEC Series(IEC language)

Device name	Device type	Display format	Range of values
%MX10 (BIT access)	15 (BIT)	1 (Signed decimal number)	0, 1
%IB0.0.4 (BYTE access)	4 (USINT)	2 (hexadecimal number)	16#00 ~16#FF
%MW90 (WORD access)	1 (INT)	0 (Signed decimal number)	-32768 ~32767
%UL0.10.7 (LWORD access)	9 (LREAL)	0 (Signed decimal number)	-1.7976931348623157e+308 ~ -2.2250738585072014e-308 or 0 or 2.2250738585072014e-308 ~ 1.7976931348623157e+308 (0 -> 0.0000000000000000e+000)

Appendix 4.2 Individual exercise related to the user page

The following provides the samples required to make the user web page. The samples are as shown below.

- ▷ Login/logout exercise : Login or logout of the user page
- ▷ Read/Write device value exercise: Reading or writing the device value
- ▷ PLC Run/Stop exercise : Running or stopping the PLC
- ▷ Exercise related to update of the web page by cycle: Updating the web page by cycle (You can select the cycle)
- ▷ Exercise related to automatic Refresh of the web page : Updating the web page automatically
- ▷ List exercise : If you click the list, the relevant page corresponding to the list will be loaded.
- ▷ Ring buffer exercise : data Saving the data value to the list periodically (If the buffer is full, the oldest data will be deleted and then, the latest one will be saved.)
- ▷ On, Off exercise : Outputting the relevant image depending on the device data value(0 or 1)
- ▷ Progress bar exercise : The progress bar image may be different depending on the device data value.
- ▷ Exercise related to displaying string based on the device value : Displaying the string based on the device data value
- ▷ Web page link exercise : If you click the button, the screen will be moved to the set web page.

Appendix 4.2.1 Login/logout exercise

When a user makes the web page, the login/ logout exercise enables the user to use login, logout functions. You can register or delete accounts by using the user account settings of the basic page.



The image shows a simple login form. It consists of two text input fields. The first field is labeled 'ID :' and the second is labeled 'Password :'. Below the second field is a button labeled 'Login'.

[Fig. 4.2.1.1] login sample page

1) Sample code

The sample code to use login/logout sample is as shown below.

```
<!DOCTYPE html>
<html>
<head>
  <meta http-equiv="Content-Type" content="text/html; charset=utf-8">

  <script src="/js/jquery-1.8.1.min.js"></script>
  <script src="/KR/js/common.js"></script>
  <script src="/js/login.js"></script>
  <script src="/js/md5.js"></script>

  <script type="text/javascript">
    $(window).load(function(){
      loadLogin();
    });
```

```

/* Check the initial login state */
function loadLogin(){
    var user_view = document.getElementById("user_view");
    if(get_cookie("LSID") != null){
        uAuth = parseInt(get_cookie("AUTH"));
        var auth = "";
        if(uAuth == '0'){
            auth = 'administrator';
        }else if(uAuth == '1'){
            auth = 'general';
        }else{
            auth = uAuth;
        }
        user_view.innerHTML = get_cookie("LSID")+ ('+auth+') <input type="button" value="logout"
onclick="logout()">';
        document.getElementById("login_view").style.display='none';
        user_view.style.display = 'block';
    }else{
        document.getElementById("login_view").style.display='block';
        user_view.style.display = 'none';
    }
}

function login(){
    var id=document.getElementById('pAccount');
    var pw=document.getElementById('pPasswd');
    if(!checkParameter(id.value)){
        alert('Input the account');
    }else if(!checkParameter(pw.value)){
        alert('Input the password');
    }else{
        var sData = 'pAccount='+id.value+'&pPassword='+MD5(pw.value).toUpperCase();
        $.ajax({
            type : 'POST',
            url : '/KR/login.cgi',
            data : sData,
            dataType : "json",
            error:function(){
                alert("Access to the server has failed. Try it again.");
            },
            success:function(data){
                if(data.pCode == 100){
                    document.getElementById('pPasswd').value = "";
                    var user_view = document.getElementById("user_view");
                    pw.value = "";
                    var auth = "";
                    if(data.pAuth == '0'){
                        auth = 'administrator';
                    }else if(data.pAuth == '1'){

```

```

        auth = 'general';
    }else{
        auth = data.pAut
    }
    user_view.innerHTML = data.pAccount+' ('+auth+') <input type="button"
value="logout" onclick="logout()">';

    document.getElementById("login_view").style.display = 'none';
    user_view.style.display = 'block';
    replaceCookie(data.pAccount,data.pAuth);
}else if(data.pCode == 101){
    alert("Check the account and password.");
}
}
});
}
}

function logout(){
    $.ajax({
        type : 'GET',
        url : '/KR/logout.cgi',
        dataType : "text",
        error:function(){
            alert("Access to the server has failed. Try it again.");
        },
        success:function(data){
            deleteCookie();
            var code = data.substr(0,3);
            if(checkParameter(code)){
                if(code == '100'){
                    document.getElementById("login_view").style.display = 'block';
                    document.getElementById("user_view").style.display = 'none';
                    document.getElementById("user_view").innerHTML = "";
                    uAuth = 0;
                }else if(code == '101'){
                    alert("Access to the server has failed. Try it again.");
                }
            }else{
                alert("Access to the server has failed. Try it again.");
            }
        }
    });
}
}
</script>
</head>
<body>
<div id="user_view" style="display:none; font-weight: bold;">
</div>
<table id="login_view">
<tr>

```



```
<th>account : </th>
<td><input id="pAccout" type="text"></td>
</tr>
<tr>
<th>password : </th>
<td><input id="pPasswd" type="password"></td>
</tr>
<tr>
<th></th>
<td><input style="float:right;" type="button" value="login" onclick="login()"></td>
</tr>
</table>
</body>
</html>
```

2) Instructions for Setting

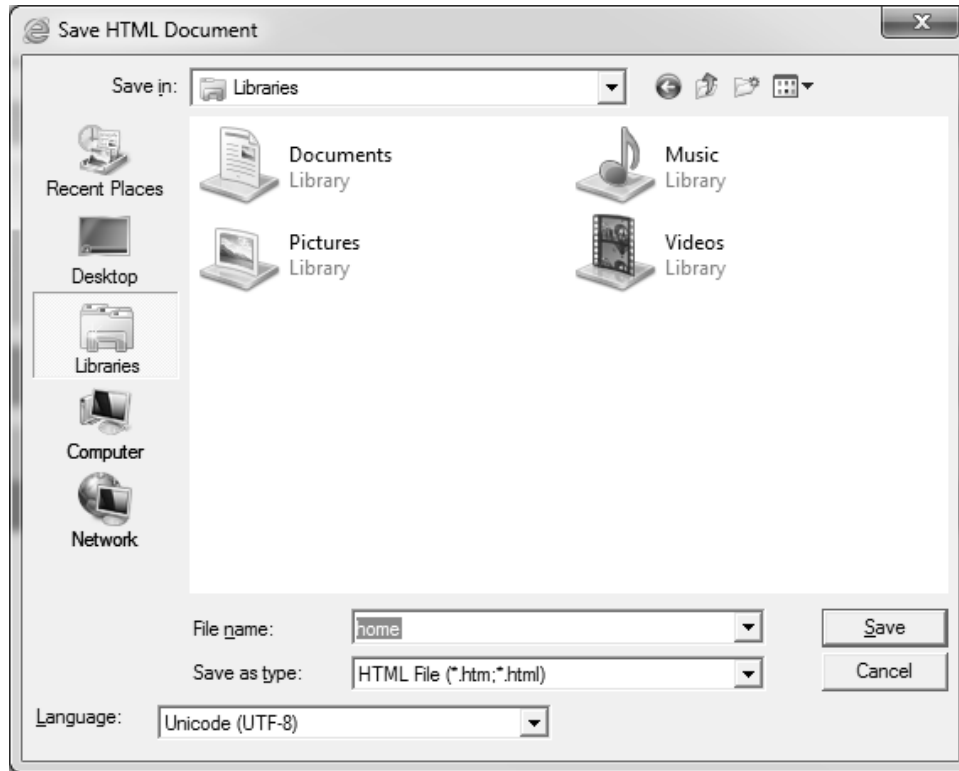

[Fig. 4.2.1.2] 'Save as'

- (1) After pasting the sample code to the note pad, click File - 'Save as' button.
- (2) After setting **filename: home.html**, **file format: all files**, **encoding: UTF-8** in [Fig. 4.2.1.2] 'Save as' window, click the 'Save' button.
- (3) After saving the file, log in to the web server with the administrator privilege.
- (4) Move to Setting-User page and click the 'Select File' button.
- (5) If you select the saved 'home.html' file and click the 'Open' button, the file will be transferred to the web server.
- (6) After file transfer is done, input the below URL to the web page.
- (7) - **http://xxx.xxx.xxx.xxx/userpage/home.html**
- (8) - **xxx.xxx.xxx.xxx** means the web server's IP.
- (9) If you load the web page by entering the URL, [Fig. 4.2.1.1] login sample page will be loaded.

3) How to use(login)

- (1) Input the account and password to [Fig. 4.2.1.1]login sample page and click the login button.
- (2) If you click the button, [Fig. 4.2.1.2]login state page will be created.

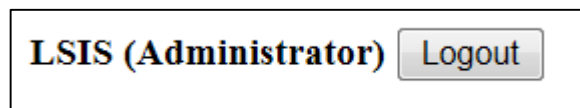

[Fig. 4.2.1.3] Login state page

4) How to use (logout)

- (1) Click the logout button in [Fig. 4.2.1.2] login state page.
- (2) If you click the button, [Fig. 4.2.1.1] login sample page will be created again.

Notice

- (1) For more details on how to transfer the user page, refer to 'User Page Setting Functions' of the web server manual.
- (2) For more details on login account management, refer to 'User Account' of the web server manual.

Appendix 4.2.2 language conversion exercise

It is the exercise to change the web page's language.(Korean/English)

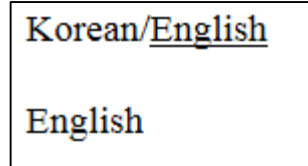

[Fig. 4.2.2.1] Sample page of language conversion

1) Sample code

The sample code to use the language conversion sample is as shown below.

```
<!DOCTYPE html PUBLIC "-//W3C//DTD HTML 4.01 Transitional//EN" "http://www.w3.org/TR/html4/loose.dtd">
<html>
<head>
  <meta http-equiv="p3p" content="CP="CAO DSP AND SO" policyref="/w3c/p3p.xml">
  <meta http-equiv="Content-Type" content="text/html; charset=UTF-8">
  <script src="/js/jquery-1.8.1.min.js"></script>
  <script src="/js/jquery.cookie.js"></script>
  <script type="text/javascript">

    function getLanguage(){
      var lng = $.cookie('LANGUAGE');
      if(lng!=null){
        setFrame(lng);
      }else{
        var type=navigator.appName
        var lang = null;
        if (type=="Netscape")lang = navigator.language;
        else lang = navigator.browserLanguage;
        if (lang.indexOf("ko") > -1)setFrame('ko');
        else setFrame('en');
      }
    }

    function setFrame(lng){
      var langTag = document.getElementById('LANG');
      if(lng == 'ko'){
        langTag.innerHTML = 'Korean';
        document.getElementById('KOR').style.textDecoration = 'underline';
        document.getElementById('ENG').style.textDecoration = 'none';
      }else if(lng == 'en'){
        langTag.innerHTML = 'English';
        document.getElementById('KOR').style.textDecoration = 'none';
        document.getElementById('ENG').style.textDecoration = 'underline';
      }else{
        langTag.innerHTML = lng;
      }
    }
  </script>
</head>
</html>
```

```

    }
}

function setLanguage(ver){
    top.document.cookie = 'LANGUAGE='+escape(ver)+'; path=/';
    top.document.location.reload();
    //document.location.href = 'about:blank';
}

</script>
</head>

<body onload="getLanguage()">
    <div>
        <font color="#000000"><a id="KOR" onclick="javascript:setLanguage('ko');" style="text-decoration:underline; cursor: pointer;"
target="_parent">Korean</a><a id="ENG" onclick="javascript:setLanguage('en');" style="text-decoration:none; cursor: pointer;"
target="_parent">English</a></font>
    </div>
    <div style="position: relative; top:20px;" id="LANG"></div>
</body>
</html>

```

2) How to use(conversion into English)

- (1) Click the 'English' button in [Fig. 4.2.2.1] language conversion sample page.
- (2) If you click the button, [Fig. 4.2.2.2] English sample page will be created.

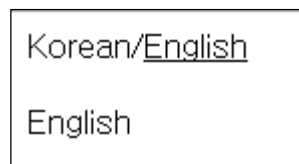

[Fig. 4.2.2.2] English sample page

Appendix 4.2.3 Exercise related to reading/writing device values

The exercise enables you to read or write the PLC's device values.

Device :	M0000 0 2
Type :	UINT
Display format :	Hexa decimal
Value :	<input type="text" value="0020"/> <input type="button" value="Write"/>

[Fig. 4.2.3.1] Sample page of reading/writing device values

1) Sample code

The sample code to read or write device values is as shown below.

```
<!DOCTYPE html PUBLIC "-//W3C//DTD HTML 4.01 Transitional//EN" "http://www.w3.org/TR/html4/loose.dtd">
<html>
<head>

<meta http-equiv="Content-Type" content="text/html; charset=UTF-8">
<script src="/js/jquery-1.8.1.min.js"></script>
<script src="/KR/js/common.js"></script>
<script src="/KR/js/deviceTypeList.js"></script>
<script src="/js/biginteger.js"></script>

<!-- EUC-KR code table -->
<script src="/js/KSC5601.js"></script>

<script type="text/javascript">

    /*-----Input Area-----*/
    var pDevice = 'M0000';
    var pType = 5;
    var pSystem = 2;
    //XEC TYPE
    //var pDevice = '%MMO';
    //var pType = 5;
    //var pSystem = 2;
    /*-----*/

    var pHex = deviceType[pType].hex;
    var pCommand = pDevice+' 0 '+pHex;

    pType++;
    pSystem++;

```

```

function getDevice(form){
    if(!checkTypeSys(pType, pSystem)){
        alert(" Check the type and display format");
        return false;
    }
    $.ajax({
        type : 'GET',
        url : '/KR/read_device_data.cgi?pCommand='+pCommand+'&pType='+pType,
        dataType : "json",
        global: false,
        error:function(){
            alert("Access to the server has failed. Try it again.");
        },
        success:function(data){
            sendForm = document.sendForm;
            if(checkParameter(data.pSystem)){
                pSystem = data.pSystem;
            }
            document.getElementById('device_name').innerHTML = pCommand;
            document.getElementById('pType').innerHTML = deviceType[pType-1].name;
            document.getElementById('pSystem').innerHTML = valueType[pSystem-1].name;
            sendForm.pCommand.value = pCommand;
            sendForm.pType.value = pType;
            sendForm.pValue.value = checkType(pSystem,data.pValue,pType);
        }
    });
}

```

```

function setDevice(form){
    if(!checkTypeSys(pType, pSystem)){
        alert("Check the type and display format");
        return false;
    }else if(!checkValueLength(parseInt(pType), pSystem, form.pValue.value)){
        form.pValue.focus();
        return;
    }else{
        form.pValue.value = setTypeValue(pType,pSystem,form);
        form.pCommand.value = Base64.encode(pDevice+ ' 1 '+pHex);
        var sData = $('#sendForm').serialize();
        $.ajax({
            type : 'POST',
            url : '/KR/write_device_data.cgi',
            dataType : "text",
            data:sData,
            error:function(){
                alert("Access to the server has failed. Try it again.");
                getDevice();
            },
            success:function(data){
                var code = data.substr(0,3);
            }
        });
    }
}

```

```

        if(checkParameter(code)){
            if(code == '100'){
                alert('Registered');
            }else{
                alert("Access to the server has failed. Try it again.");
            }
            getDevice();
        }
    }
});
}
/* if(!checkParameter(form.pCommand.value) || (!checkParameter(form.pType.value))){
    //alert('READ the device');
}else if(!checkParameter(form.pValue.value)){
    alert('Check the value');
    form.pValue.focus();
}else if(!checkValueLength(form.pType.value, pSystem, form.pValue.value)){

}
} */
}
</script>
</head>

<body onload="getDevice();">
<form id="readForm" name="readForm">
    <table>
        <tr>
            <th>device : </th>
            <td id="device_name">
            </td>
        </tr>
        <tr>
            <th>type : </th>
            <td id="pType">
            </td>
        </tr>
        <tr>
            <th>display format : </th>
            <td id="pSystem">
            </td>
        </tr>
    </table>
</form>
<form id="sendForm" name="sendForm">
    <table>
        <tr>
            <th>value : </th>

```



```
<td>
  <input name="pCommand" type="hidden">
  <input name="pType" type="hidden">
  <input name="pValue" type="text">
  <input type="button" value="Write" onclick="javascript:setDevice(document.sendForm);">
</td>
</tr>
</table>
</form>
</body>
</html>
```

2) Instructions for Setting

- (1) Paste the sample code to the note pad.
- (2) Input the device name and type, display format to read/write to the 'Input Area' of the sample code.
- (3) After inputting data, click the File - 'Save as' button in the note pad menu.
- (4) After setting **filename: home.html, file format: all files, encoding: UTF-8** in [Fig. 4.2.1.2] 'Save as' window, click the 'Save' button.
- (5) After saving the file, log in to the web server with the administrator privilege.
- (6) Move to Setting-User page and click the 'Select File' button
- (7) If you select the saved 'home.html' file and click the 'Open' button, the file will be transferred to the web server.
- (8) After file transfer is done, input the below URL to the web page.
- (9) - **http://xxx.xxx.xxx.xxx/userpage/home.html**
- (10) - **xxx.xxx.xxx.xxx** means the web server's IP.
- (11) If you load the web page by entering the URL, [Fig. 4.2.2.1] sample page of reading/writing device values will be loaded.

3) How to use(Reading device values)

- (1) Click the 'Web page update(F5)' button.
- (2) The device values set in the sample page will be read in [Fig. 4.2.2.1] edit box.

4) How to use(Writing device values)

- (1) Input the value to write to [Fig. 4.2.2.1] edit box
- (2) After inputting the value, click the 'Write' button.
- (3) If you click the button, [Fig. 4.2.2.2] window for registering devices will be created.

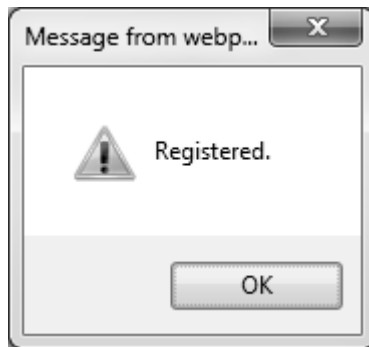

[Fig. 4.2.3.2] Window for registering devices

- (4) Click the OK button in [Fig. 4.2.3.2] window for registering devices.
- (5) If you click the button, the revised value will be input to [Fig. 4.2.2.3] edit box.

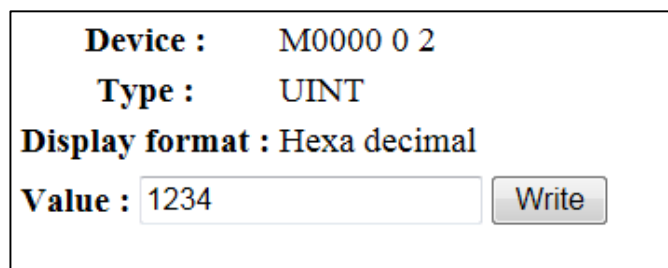

[Fig. 4.2.3.3] Read/Write device values page

Notice

- (1) For more details on how to transfer the user page, refer to 'User Page Setting Functions' of the web server manual.
- (2) For more details on login account management, refer to 'User Account Setting' of the web server manual
- (3) For setting the parameters of the sample code, refer to 'Device Monitoring Parameters' of the previous Chapter.

Appendix 4.2.4 PLC Run/Stop exercise

The exercise enables you to change the PLC's operation mode into Run or Stop.

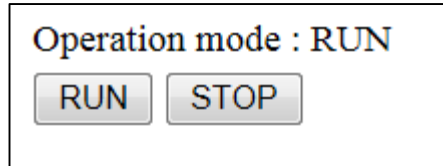

[Fig. 4.2.4.1] PLC Run/Stop sample page

1) Sample code

The sample code to convert the PLC's operating mode into Run or Stop is as shown below.

```

<!DOCTYPE html>
<html>
<head>
  <meta http-equiv="Content-Type" content="text/html; charset=utf-8">

  <script src="/js/jquery-1.8.1.min.js"></script>
  <script src="/KR/js/deviceTypeList.js"></script>
  <script type="text/javascript">

    /*-----Input Area-----*/
    //XBC TYPE
    var pDevice = 'M00000';
    var pType = 15;
    var pSystem = 1;
    //XEC TYPE
    //var pDevice = '%MX0';
    //var pType = 15;
    //var pSystem = 1;
    /*-----*/

    pType++;
    pSystem++;

    $(window).load(function(){
      getDeviceState();
    });

    function getDeviceState(){
      /*

      checkTypeSys(pType, pSystem)

      - Check whether the display format is proper for the type.

      */

```

```

if(!checkTypeSys(pType, pSystem)){
    alert("Check the type and display format ");
    return false;
}
var pCommand = pDevice+' 0 '+deviceType[pType-1];
$.ajax({
    type : 'GET',
    url : '/KR/read_device_data.cgi?pCommand='+pCommand+'&pType='+pType,
    dataType : "json",
    global: false,
    error:function(){
        alert("Access to the server has failed. Try it again.");
    },
    success:function(data){
        if(data.pValue == '1'){
            $("#state_image").html('operating mode : RUN');
        }
        else if(data.pValue == '0'){
            $("#state_image").html('operating mode : STOP');
        }else{
            $("#state_image").html('operating mode : unknown value. ');
        }
    }
});
}

function setDeviceState(val){
    if(!checkTypeSys(pType, pSystem)){
        alert("Check the type and display format ");
        return false;
    }
    $.ajax({
        type: 'POST',
        url: "/KR/set_plc_run.cgi",
        data: 'mode='+val,
        dataType : "text",
        error:function(){
            alert("Access to the server has failed. Try it again.");
        },
        success:function(data, code){
            var code = data.substr(0,3);
            if(code == '100'){
                if(val == '1'){
                    $("#state_image").html('operating mode : RUN');
                }
                else if(val == '0'){
                    $("#state_image").html('operating mode : STOP');
                }
            }
        }
    })
}

```

```

        });
    }
</script>
</head>
<body>
<table>
  <tr>
    <td id="state_image"></td>
  </tr>
  <tr>
    <td><input type="button" value="RUN" onclick="setDeviceState(1)"> <input type="button" value="STOP"
onclick="setDeviceState(0)"></td>
  </tr>
</table>

</body>
</html>

```

2) Instructions for Setting

- (1) Paste the sample code to the note pad.
- (2) Input the **F00000**(IEC: %FX0) flag parameter to the '**Input Area**' of the sample code in order to check
- (3) Run or Stop operation.
- (4) After inputting parameters, click the File - 'Save as' button in the note pad menu.
- (5) After setting **filename: home.html, file format: all files, encoding: UTF-8** in [Fig. 4.2.1.2] 'Save as' window, click the 'Save' button
- (6) After saving the file, log in to the web server with the administrator privilege.
- (7) Move to Setting-User page and click the 'Select File' button.
- (8) If you select the saved 'home.html' file and click the 'Open' button, the file will be transferred to the web server.
- (9) After file transfer is done, input the below URL to the web page.
- (10) - **http://xxx.xxx.xxx.xxx/userpage/home.html**
- (11) - **xxx.xxx.xxx.xxx** means the web server's IP.
- (12) If you load the web page by entering the URL, [Fig. 4.2.4.1] PLC Run/Stop sample page will be loaded.

3) How to use(PLC Run/Stop)

- (1) Click the RUN or STOP button in the middle of [Fig. 4.2.4.1] PLC Run/Stop page.
- (2) If you click the button, the PLC's operation will be changed and the operation mode at the top of [Fig. 4.2.4.1] PLC Run/Stop page will be converted into 'RUN' or 'STOP'.

Appendix 4.2.5 Exercise related to update of the web page by cycle

The exercise enables a user to update the web page on the cycle(10 seconds, 20 seconds, 30 seconds, 1 minute) that the user wants by using the combo box.

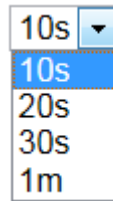

[Fig. 4.2.5.1] Sample page of update of the web page by cycle

1) Sample code

The sample code for updating the web page by cycle is as shown below.

```
<!DOCTYPE html>
<html>
<head>
  <meta http-equiv="Content-Type" content="text/html; charset=utf-8">
  <script type="text/javascript">
    var rTime = 10;
    var rplc = null;

    function setAutoReplace(time){
      rTime = time;
      if(rplc != null){
        clearInterval(rplc);
      }
      if(rTime != 0){
        rplc = setInterval("refresh()", rTime*1000);
      }
    }
    function refresh(){
      document.getElementById("selection").style.display = 'none';
      setTimeout('refresh2();',50);
    }

    function refresh2(){
      document.getElementById("selection").style.display = 'block';
    }
  </script>
</head>
<body onload="setAutoReplace(rTime);">
  <select id="selection" onChange="setAutoReplace(this.value);"style="position: absolute; top:10px; left: 10px;">
    <option value="10">10 seconds</option>
    <option value="20">20 seconds</option>
```

```
<option value="30">30 seconds</option>
<option value="60">1 minute</option>
</select>
</body>
</html>
```

2) Instructions for Setting

- (1) After pasting the sample code to the note pad, click File - 'Save as' button
- (2) After setting **filename: home.html**, **file format: all files**, **encoding: UTF-8** in [Fig. 4.2.1.2] 'Save as' window, click the 'Save' button
- (3) After saving the file, log in to the web server with the administrator privilege.
- (4) Move to Setting-User page and click the 'Select File' button.
- (5) If you select the saved 'home.html' file and click the 'Open' button, the file will be transferred to the web server.
- (6) After file transfer is done, input the below URL to the web page.
- (7) - **http://xxx.xxx.xxx.xxx/userpage/home.html**
- (8) - **xxx.xxx.xxx.xxx means** the web server's IP.
- (9) If you load the web page by entering the URL, [Fig. 4.2.5.1] Sample page of update of the web page by cycle will be loaded.

3) How to use(web page update)

- (1) Select the desired update cycle (10 seconds, 20 seconds, 30 seconds, 1 minute) in [Fig. 4.2.5.1] Sample page of update of the web page.
- (2) The web page will be updated according to the selected update cycle.

Appendix 4.2.6 Exercise related to automatic update of the web page

The exercise enables you to update the web page based on the internally set cycle.

1) Sample code

The sample code for automatic update of the web page is as shown below.

```
<!DOCTYPE html>
<html>
<head>
<meta http-equiv="Content-Type" content="text/html; charset=UTF-8">
<script type="text/javascript">
  /*----- Input Area -----*/
  var rTime = 3;      //3 seconds
  /*-----*/
  var rplc = null;
  function setAutoReplace(time){
    rTime = time;
    if(rplc != null){
      clearInterval(rplc);
    }
    rplc = setInterval("load()", time*1000);
  }
  function load(){
    alert(rTime+'Updated in seconds');
  }
</script>
</head>
<body onload="setAutoReplace(rTime);">

</body>
</html>
```

2) Instructions for Setting

- (1) Paste the sample code to the note pad.
- (2) Input the update cycle to the '**Input Area**' of the sample code.
- (3) After inputting the cycle, click the File - 'Save as' button in the note pad menu
- (4) After setting **filename: home.html, file format: all files, encoding: UTF-8** in [Fig. 4.2.1.2] 'Save as' window, click the 'Save' button
- (6) After saving the file, log in to the web server with the administrator privilege.
- (7) Move to Setting-User page and click the 'Select File' button.
- (8) If you select the saved 'home.html' file and click the 'Open' button, the file will be transferred to the web server.
- (9) After file transfer is done, input the below URL to the web page.
- (10) - **http://xxx.xxx.xxx.xxx/userpage/home.html**
- (11) - **xxx.xxx.xxx.xxx means** the web server's IP.
- (12) Input the URL to load the web page.

3) How to use

- (1) If you load the web page, the web page will be automatically updated on the cycle set in the sample code.

Appendix 4.2.7 list exercise

If you click the List menu, the exercise shows the relevant page.

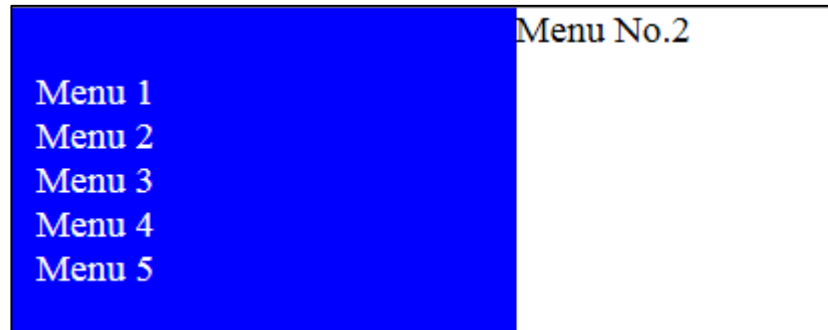

[Fig. 4.2.6.1] Sample page of the list

1) Sample code

The sample code of the list exercise is as shown below.

```
<!DOCTYPE html>
<html>
<head>
  <meta http-equiv="Content-Type" content="text/html; charset=utf-8">
  <style type="text/css">
    #menu_list {list-style: none; padding:0px;}
    #menu_list li {cursor: pointer;}
  </style>
  <script src="/js/jquery-1.8.1.min.js"></script>
  <script type="text/javascript">
    function setView(idx){
      var tag = '<div>menu '+(idx+1)+'No.</div>';
      $('#view').html(tag);
    }
  </script>
</head>
<body>
  <div style="position:absolute; top:0; left:0; width:190px; background-color: blue; color:white; padding:
  bottom:0px;">
    <ul id="menu_list"style="">
      <li onclick="setView(0);">menu1</li>
      <li onclick="setView(1);">menu2</li>
      <li onclick="setView(2);">menu3</li>
      <li onclick="setView(3);">menu4</li>
      <li onclick="setView(4);">menu5</li>
    </ul>
  </div>
  <div style="position:absolute; top:0; left:210px; right:0px; bottom:0px;" id="view">
```

```
</div>  
</body>  
</html>
```

2) Instructions for Setting

- a) After pasting the sample code to the note pad, click File - 'Save as' button.
- b) [After setting **filename: home.html**, **file format: all files**, **encoding: UTF-8** in [Fig. 4.2.1.2] 'Save as' window, click the 'Save' button.
- c) After saving the file, log in to the web server with the administrator privilege.
- d) Move to Setting-User page and click the 'Select File' button.
- e) If you select the saved 'home.html' file and click the 'Open' button, the file will be transferred to the web server.
- f) After file transfer is done, input the below URL to the web page.
- g) - **http://xxx.xxx.xxx.xxx/userpage/home.html**
- h) - **xxx.xxx.xxx.xxx** means the web server's IP.
- i) If you load the web page by entering the URL, [Fig. 4.2.6.1] sample page of the list will be loaded.

3) How to use

- a) Click the menu button on the left of the [Fig. 4.2.6.1] list page.
- b) If you click the button, the set text will be displayed on the right of [Fig. 4.2.6.1] list page.

Appendix 4.2.8 Ring buffer exercise

It is the exercise that can save the device data values in the list and monitor them. In the ring buffer structure, after the data is all input to the list, if the latest data is input, the oldest data will be removed and the latest one will be saved.

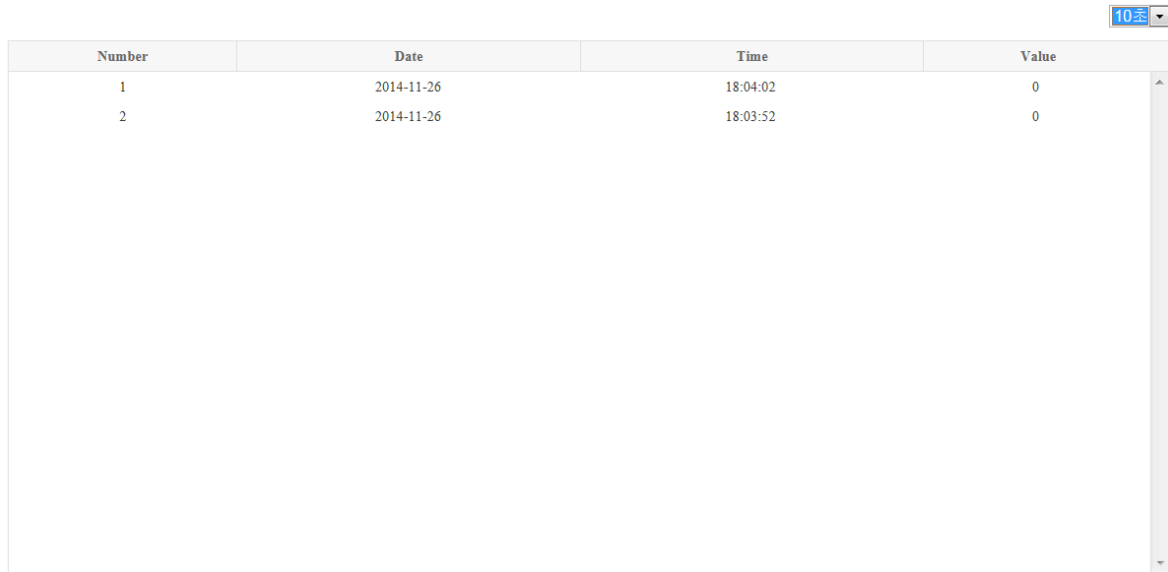

Number	Date	Time	Value
1	2014-11-26	18:04:02	0
2	2014-11-26	18:03:52	0

[Fig. 4.2.7.1] Sample page of Ring buffer

1) Sample code

The sample code for ring buffer is as shown below.

```
<!DOCTYPE html>
<html>
<head>
  <meta http-equiv="Content-Type" content="text/html; charset=utf-8">
  <link href="/KR/css/Table.css" rel="stylesheet" type="text/css">
  <script src="/js/jquery-1.8.1.min.js"></script>
  <script src="/KR/js/common.js"></script>
  <script src="/KR/js/deviceTypeList.js"></script>
  <script src="/js/biginteger.js"></script>
  <script type="text/javascript">

    /*-----Input Area-----*/
    //XBC TYPE
    var pDevice = 'M00000';
    var pType = 0;
    var pSystem = 0;
    //XEC TYPE
    //var pDevice = '%MB0';
    //var pType = 0;
    //var pSystem = 0;
    /*-----*/

    var pHex = deviceType[pType].hex;
    var pCommand = pDevice+' 0 '+pHex;
```

```

pType++;
pSystem++;

var buff = [];

var rTime = 10;
var rplc = null;

$(window).load(function(){
    setAutoReplace(rTime);
});

function setAutoReplace(time){
    rTime = time;
    if(rplc != null){
        clearInterval(rplc);
    }
    if(rTime != 0){
        rplc = setInterval("getTempLog()", rTime*1000);
    }
}

function getTempLog(){
    if(!checkTypeSys(pType, pSystem)){
        alert("Check the type and display format ");
        return false;
    }
    var dev_list = document.getElementById("dev_list");
    if(dev_list.style.display != 'none'){
        $.ajax({
            type : 'GET',
            url : '/KR/read_device_data.cgi?pCommand='+pCommand+'&pType='+pType,
            dataType : "json",
            global: false,
            error:function(){
                alert("Access to the server has failed. Try it again.");
            },
            success:function(data){
                buff.unshift(data);
                var list = $('#temp_table_list');
                list.html("");
                var tr = "";
                while(buff.length > 20){
                    buff.pop();
                }
                for(var i=0;i<buff.length;i++){
                    tr += '<tr>';
                    tr += '<td>'+(i+1)+'</td>';
                }
            }
        });
    }
}

```

```

        tr += '<td>'+buff[i].pDate+'</td>';
        tr += '<td>'+buff[i].pTime+'</td>';

/*checkType(pSystem,value,pType); - Output the value that is suitable for the type and display format.*/
        tr += '<td>'+checkType(pSystem,buff[i].pValue,pType)+'</td>';
        tr += '</tr>';
    }
    list.html(tr);
    }
    });
}
}
</script>
</head>
<body>
<div id="dev_list" style="position: absolute; top:10px; left:10px; right: 0px; bottom:0px;">
    <select onChange="setAutoReplace(this.value);"style="position: absolute; top:10px; right: 10px;">
        <option value="10">10 seconds</option>
        <option value="20">20 seconds</option>
        <option value="30">30 seconds</option>
        <option value="60">1 minute</option>
    </select>
    <div class="list_table" style="position: absolute; top:40px; left:10px; right: 10px;">
        <div class="table_header">
            <table cellpadding="0">
                <colgroup>
                    <col width="20%">
                    <col width="30%">
                    <col width="30%">
                    <col width="20%">
                </colgroup>
                <thead>
                <tr>
                    <th scope="col">No.</th>
                    <th scope="col">date</th>
                    <th scope="col">time</th>
                    <th scope="col">value</th>
                </tr>
                </thead>
            </table>
        </div>
        <div class="table_list" style="height: 425px; max-height:auto;">
            <table cellpadding="0">
                <colgroup>
                    <col width="20%">
                    <col width="30%">
                    <col width="30%">
                    <col width="20%">
                </colgroup>
                <tbody id="temp_table_list">

```

```
                </tbody>
            </table>
        </div>
    </div>
</div>
</body>
</html>
```

2) Instructions for Setting

- (1) Paste the sample code to the note pad.
- (2) Input the name and type, display format of the device to monitor to the **'Input Area'** of the sample code.
- (3) After inputting data, click the File - 'Save as' button in the note pad menu.
- (4) After setting **filename: home.html, file format: all files, encoding: UTF-8** in [Fig. 4.2.1.2] 'Save as' window, click the 'Save' button
- (5) After saving the file, log in to the web server with the administrator privilege.
- (6) Move to Setting-User page and click the 'Select File' button.
- (7) If you select the saved 'home.html' file and click the 'Open' button, the file will be transferred to the web server.
- (8) After file transfer is done, input the below URL to the web page.
- (9) - **http://xxx.xxx.xxx.xxx/userpage/home.html**
- (10) - **xxx.xxx.xxx.xxx means** the web server's IP.
- (11) If you load the web page by entering the URL, [Fig. 4.2.7.1] sample page of ring buffer will be loaded.

3) How to use

- (1) Set up the update cycle in the top right corner of [Fig. 4.2.7.1] ring buffer page.
- (2) The data will be input to the list according to the set cycle.

Notice

(1) The ring buffer works only when the web page is opened. If you move to the other page and load the page again, all data will disappear.

Appendix 4.2.9 On/Off exercise

It is the exercise to change the image depending on device values(BOOL).



[Fig. 4.2.8.1] On/Off sample page(Off)

1) Sample code

The sample code of the On/Off exercise is as shown below.

```

<!DOCTYPE html>
<html>
<head>
  <meta http-equiv="Content-Type" content="text/html; charset=utf-8">
  <script src="/js/jquery-1.8.1.min.js"></script>
  <script src="/KR//js/common.js"></script>
  <script src="/KR//js/deviceTypeList.js"></script>
  <script src="/KR//js/biginteger.js"></script>
  <script type="text/javascript">

    /*-----Input Area-----*/
    var pDevice = 'M00000';
    var pType = 15;
    var pSystem = 1;
    /*-----*/

    var pCommand = pDevice+' 0 0';
    pType++;
    pSystem++;

    $(window).load(function(){
      getDeviceState();
    });

    function getDeviceState(){
/*checkTypeSys(pType, pSystem)- Check the suitable display format for the type. */
      if(!checkTypeSys(pType, pSystem)){
        alert("Check the type and display format ");
        return false;
      }
      $.ajax({
        type : 'GET',
        url : '/KR/read_device_data.cgi?pCommand='+pCommand+'&pType='+pType,
        dataType : "json",
        global: false,

```

```

        error:function(){
            alert("Access to the server has failed. Try it again.");
        },
        success:function(data){
            if(data.pValue == '1'){
                $("#state_image").html('');
                $("#state_text").html('RUN')
            }
            else if(data.pValue == '0'){
                $("#state_image").html('');
                $("#state_text").html('STOP')
            }
        }
    });
}
</script>
</head>
<body>
<table>
    <tr>
        <td id="state_image" style="height:20px; padding:2px 7px;"></td>
    </tr>
    <tr>
        <td id="state_text"></td>
    </tr>
</table>

</body>
</html>

```

2) Instructions for Setting

- (1) Paste the sample code to the note pad.
- (2) Input the parameters to the 'Input Area' of the sample code.
- (3) After inputting parameters, click the File - 'Save as' button in the note pad menu
- (4) After setting **filename: home.html**, **file format: all files**, **encoding: UTF-8** in [Fig. 4.2.1.2] 'Save as' window, click the 'Save' button.
- (5) After saving the file, log in to the web server with the administrator privilege.
- (6) Move to Setting-User page and click the 'Select File' button.
- (7) If you select the saved 'home.html' file and click the 'Open' button, the file will be transferred to the web server.
- (8) After file transfer is done, input the below URL to the web page.
 - http://xxx.xxx.xxx.xxx/userpage/home.html
- (9) - **xxx.xxx.xxx.xxx means** the web server's IP.
- (10) If you load the web page by entering the URL, [Fig. 4.2.8.1] On/Off sample page will be loaded.

3) How to use

- (1) Change the device value input to the 'Input Area' of the sample code from 0 into 1 in the state that [Fig. 4.2.8.1] On/Off sample page is loaded.
- (2) Update the web page with F5 button.
- (3) When the web page is updated, the image will be changed from Red into Green as shown in [Fig. 4.2.8.2] On/Off sample page.



[Fig. 4.2.8.2] On/Off sample page(On)

Appendix 4.2.10 Progress bar exercise

It is the exercise to change the image of the progress bar depending on the device values.

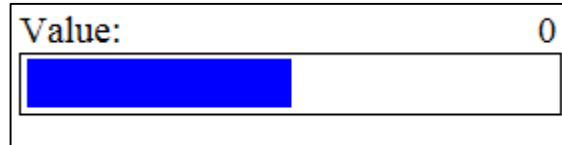

[Fig. 4.2.9.1] Progress bar sample page

1) Sample code

```

<!DOCTYPE html>
<html>
<head>
  <meta http-equiv="Content-Type" content="text/html; charset=utf-8">
  <script src="/js/jquery-1.8.1.min.js"></script>
  <script src="/KR/js/common.js"></script>
  <script src="/KR/js/deviceTypeList.js"></script>
  <script src="/js/biginteger.js"></script>
  <script type="text/javascript">

    /*-----Input Area-----*/
    //XBC TYPE
    var pDevice = 'M00000';
    var pType = 0;
    var pSystem = 0;
    //XEC TYPE
    //var pDevice = '%MB0';
    //var pType = 0;
    //var pSystem = 0;
    /*-----*/

    pType++;
    pSystem++;

    $(window).load(function(){
      getDeviceState();
    });

    function getDeviceState(){

      /*checkTypeSys(pType, pSystem)- Check the suitable display format for the type.*/

      if(!checkTypeSys(pType, pSystem)){
        alert("Check the type and display format");
        return false;
      }
    }
  </script>
</head>
</html>

```

```

var pCommand = pDevice+' 0 '+deviceType[pType-1].hex;
$.ajax({
    type : 'GET',
    url : '/KR/read_device_data.cgi?pCommand='+pCommand+'&pType='+pType,
    dataType : "json",
    global: false,
    error:function(){
        alert("Access to the server has failed. Try it again.");
    },
    success:function(data){

/* checkType(pSystem,value,pType):- Output the value that is suitable for the type and display format.
   checkValuePercentage(pType,pSystem,val);
   - Convert the value into the minimum or maximum percentage based on the type and display format.
   (clock data, text is not available).*/

        var val = checkType(pSystem, data.pValue, pType);
        var temp = checkValuePercentage(pType,pSystem,val);
        $('#state_text').html(val);
        $('#dev_progress_bar').width(temp+'%');
    }
});
}
</script>
</head>
<body>
<table>
<tr>
<td>
<div style="width:224px; height:18px;">
    <span style="float:left;">value:</span>
    <span style="float:right;" id="state_text">30 degree</span>
</div>
<div style="width:220px; height:20px; border:1px solid black; padding:2px;">
<div id="dev_progress_bar" style="background-color:blue; width:0%; height:100%;"></div>
</div>
</td>
</tr>
</table>
</body>
</html>

```

2) Instructions for Setting

- (1) Paste the sample code to the note pad.
- (2) Input the device name and display format to the '**Input Area**' of the sample code.
- (3) After inputting data, click the File - 'Save as' button in the note pad menu
- (4) After setting **filename: home.html, file format: all files, encoding: UTF-8** in [Fig. 4.2.1.2] 'Save as' window, click the 'Save' button
- (5) After saving the file, log in to the web server with the administrator privilege.
- (6) Move to Setting-User page and click the 'Select File' button.
- (7) If you select the saved 'home.html' file and click the 'Open' button, the file will be transferred to the web server.
- (8) After file transfer is done, input the below URL to the web page.
 - `http://xxx.xxx.xxx.xxx/userpage/home.html`
 - **xxx.xxx.xxx.xxx means** the web server's IP.
- (9) If you load the web page by entering the URL, [Fig. 4.2.9.1] sample page of progress bar will be loaded.

3) How to use

- (1) Load [Fig. 4.2.9.1] sample page of progress bar.
- (2) Change the device value input to the 'Input Area' of the sample code.
- (3) After changing the device value, press the F5 button to update the web page.
- (4) When the web page is updated, the image and value of [Fig. 4.2.9.1] sample page of progress bar will be changed.

Notice

- (1) You can change the device values by using the device monitoring function of XG5000 or the web server.

Appendix 4.2.11 Exercise related to displaying string depending on device values

It is the exercise to change the string depending on the device values.

State Normal : Temperature value is normal.

[Fig. 4.2.10.1] Sample page of displaying string depending on device values

1) Sample code

The sample code of displaying string depending on device values is as shown the below.

```

<!DOCTYPE html>
<html>
<head>
  <meta http-equiv="Content-Type" content="text/html; charset=utf-8">
  <script src="/js/jquery-1.8.1.min.js"></script>
  <script src="/js/biginteger.js"></script>
  <script src="/KR/js/common.js"></script>
  <script src="/KR/js/deviceTypeList.js"></script>
  <script type="text/javascript">

  /*-----Input Area-----*/
  //XBC TYPE
  var pDevice = 'M00000';
  var pType = 0;
  var pSystem = 0;
  //XEC TYPE
  //var pDevice = '%MB0';
  //var pType = 0;
  //var pSystem = 0;
  /*-----*/

  pType++;
  pSystem++;

  $(window).load(function(){
    getTemp();
  });

  function getTemp(){

    /*checkTypeSys(pType, pSystem)- Check the suitable display format for the type.*/

    if(!checkTypeSys(pType, pSystem)){
      alert("Check the type and display format ");
      return false;
    }
  }

```

```

}
var pCommand = pDevice+' 0 1';

$.ajax({
  type : 'GET',
  url : '/KR/read_device_data.cgi?pCommand='+pCommand+'&pType='+pType,
  dataType : "json",
  global: false,
  error:function(){
    alert("Access to the server has failed. Try it again.");
  },
  success:function(data){
    /*checkType(pSystem,value,pType);- Output the value that is suitable for the type and display format.*/

    var temp = checkType(pSystem,data.pValue,pType);
    var tMsg = "";

    /*temp = Value according to the type and display format    */

    if(temp >= -128 && temp <= -11){
      tMsg = 'warning: The temperature value is too low.';
    }else if(temp >= -10 && temp <= 40){
      tMsg = 'normal: The temperature value is normal.';
    }else if(temp >= 41){
      tMsg = 'warning: The temperature value is too high.';
    }else{
      tMsg = 'temperature : '+temp;
    }
    $("#temp_state").html(tMsg);
  }
});
}
</script>
</head>
<body>
<table>
  <tr>
    <th>state</th>
    <td id="temp_state"></td>
  </tr>
</table>
</body>
</html>

```

2) Instructions for Setting

- (1) Paste the sample code to the note pad.
- (2) Input the device name and display format to the '**Input Area**' of the sample code.
- (3) After inputting data, click the File - 'Save as' button in the note pad menu
- (4) After setting **filename: home.html, file format: all files, encoding: UTF-8** in [Fig. 4.2.1.2] 'Save as' window, click the 'Save' button
- (5) After saving the file, log in to the web server with the administrator privilege.
- (6) Move to Setting-User page and click the 'Select File' button.
- (7) If you select the saved 'home.html' file and click the 'Open' button, the file will be transferred to the web server.
- (8) After file transfer is done, input the below URL to the web page.
 - `http://xxx.xxx.xxx.xxx/userpage/home.html`
 - **xxx.xxx.xxx.xxx means** the web server's IP.
- (9) If you load the web page by entering the URL, [Fig. 4.2.10.1] sample page of displaying string depending on device values will be loaded.

3) How to use

- (1) Load [Fig. 4.2.10.1] sample page of displaying string depending on device values.
- (2) Change the device value input to the 'Input Area' of the sample code.
- (3) The details of [Fig. 4.2.10.1] sample page of displaying string depending on device values will be changed according to the range of device values.

Notice

- (1) You can change the device values by using the device monitoring function of XG5000 or the web server.

Appendix 4.2.12 Web page link exercise

It is the exercise to move to the set web page when clicking the button.

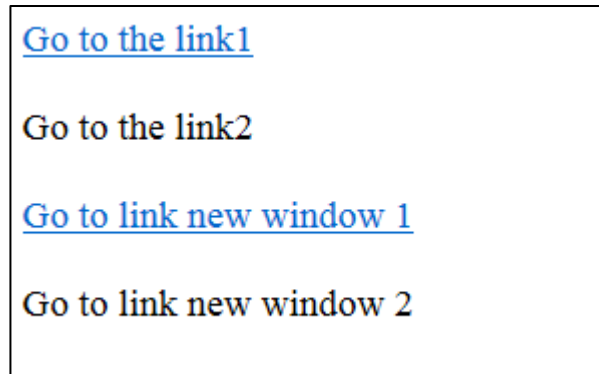

[Fig. 4.2.11.1] Sample page of web page link

1) Sample code

The sample code of the web page link is as shown below.

```
<!DOCTYPE html>
<html>
<head>
  <meta http-equiv="Content-Type" content="text/html; charset=utf-8">
</head>
<body>
  <div><a href="http://www.ls-electric.com"> Move link 1</a></div>
  <br/>
  <div onclick="javascript:document.location = 'http://www.ls-electric.com';" style="cursor:pointer">link 이동2</div>
  <br/>
  <div><a target="_blank" href="http://www.ls-electric.com"> Move link to new window 1</a></div>
  <br/>
  <div onclick="javascript>window.open('http://www.ls-electric.com', 'newWin');" style="cursor:pointer"> Move link to new window
2</div>
</body>
</html>
```

2) Instructions for Setting

- (1) Paste the sample code to the note pad.
- (2) Input the address of the targeted web page to the part displayed as heavy characters of the sample code.
- (3) After inputting data, click the File - 'Save as' button in the note pad menu
- (4) After setting **filename: home.html, file format: all files, encoding: UTF-8** in [Fig. 4.2.1.2] 'Save as' window, click the 'Save' button
- (5) After saving the file, log in to the web server with the administrator privilege.
- (6) Move to Setting-User page and click the 'Select File' button.
- (7) If you select the saved 'home.html' file and click the 'Open' button, the file will be transferred to the web server.
- (8) After file transfer is done, input the below URL to the web page.
 - **http://xxx.xxx.xxx.xxx/userpage/home.html**
 - **xxx.xxx.xxx.xxx means** the web server's IP.
- (9) If you load the web page by entering the URL, [Fig. 4.2.11.1] sample page of web page link will be loaded.

3) How to use

- (1) Load [Fig. 4.2.11.1] sample page of web page link.
- (2) Click the 'Move Link' button of the page to move to the web page input to the sample code.

Appendix 4.3 Integrated exercise for the user page : Temperature control system

The temperature control system is the integrated sample page made by using the above mentioned sample codes. The temperature control system enables you to change the operation mode of the PLC into Run or Stop and it supports Read/Write Device Values, etc. The web server user can easily make the user page by using the next exercise that will be given lastly.

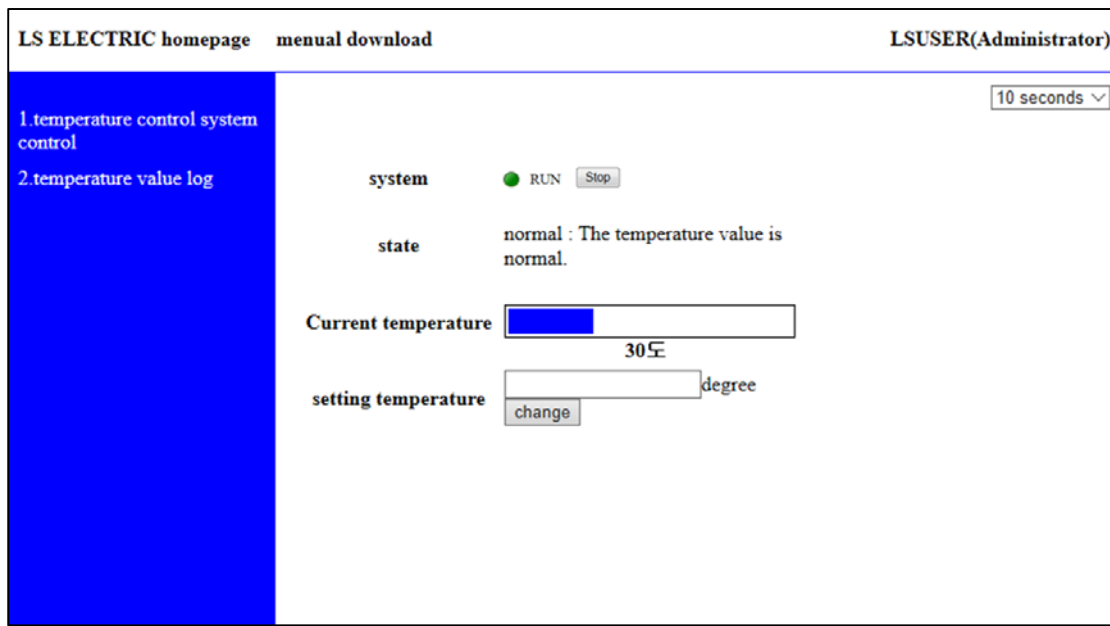

[Fig. 4.3.1] Temperature control system page

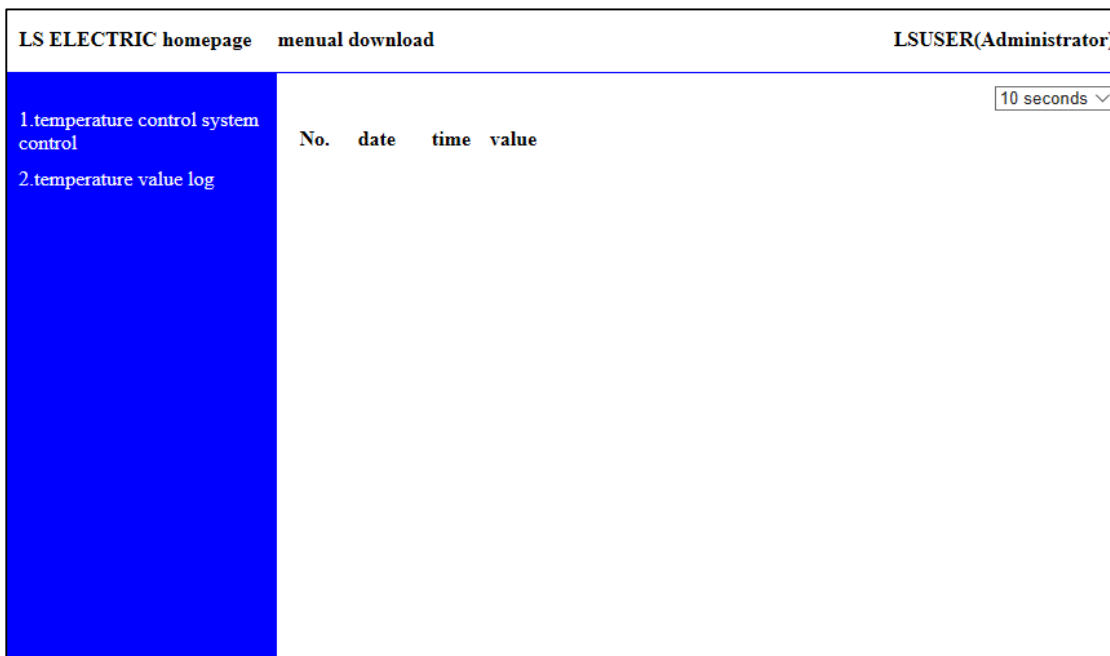

[Fig. 4.3.2] Temperature value log page

Appendix 4.3.1 Sample code

The sample code of the temperature control system is as shown below.

```
<!DOCTYPE html PUBLIC "-//W3C//DTD HTML 4.01 Transitional//EN" "http://www.w3.org/TR/html4/loose.dtd">
<html>
<head>
  <meta http-equiv="p3p" content="CP="CAO DSP AND SO" policyref="/w3c/p3p.xml">
  <meta http-equiv="Content-Type" content="text/html; charset=UTF-8">
  <style type="text/css">
    body {margin:0;}
    .div_t {display: table; width:100%; height:100%;}
    .div_c {display: table-cell; width: 100%; height: 100%; text-align: center; vertical-align: middle;}
    .main_top {font-weight: bold;}
    .top_left {float:left; width:auto; height:100%; padding:0 10px; cursor: pointer;}
    .top_right {float:right; width: auto; height:100%; padding:0 10px;}
    li {margin-bottom:10px; width:auto; cursor: pointer;}

    .main_state tr {width: 100%; height:50px;}
    .main_state th {width: 40%;}
    .main_state td {width: 60%;}
  </style>
  <link href="/KR/css/Table.css" rel="stylesheet" type="text/css">

  <!-- In case of using deviceTypeList.js , use the whole-->
  <script src="/js/jquery-1.8.1.min.js"></script>
  <script src="/js/biginteger.js"></script>
  <script src="/KR/js/common.js"></script>
  <script src="/js/login.js"></script>
  <script src="/KR/js/deviceTypeList.js"></script>

  <!-- login encrypted module -->
  <script src="/js/md5.js"></script>

  <script type="text/javascript">
    /*-----temperature value log-----*/
    //XBC TYPE
    var tempDevice = 'M00000';          // device name
    var tempType = 0;                    // type
    var tempSystem = 0;
    //XEC TYPE
    //var tempDevice = '%MB0';           //device name
    //var tempType = 0;                  //type
    //var tempSystem = 0;
    /*-----systemstate-----*/
    //XBC TYPE
    var sysDevice = 'F00000';           // device name
    var sysType = 15;                   // type
    var sysSystem = 1;
```

```

//XEC TYPE
//var sysDevice = '%FX0';      // device name
//var sysType = 15;           // type
//var sysSystem = 1;
/*-----*/

var tempHex = deviceType[tempType].hex;
var sysHex = deviceType[sysType].hex;
tempType++;
sysType++;
tempSystem++;
sysSystem++;

var rTime = 10;
var uAuth = 0;
var rplc = null;
var rlogin = null;
var buff = [];

$(window).load(function(){
    loadLogin();
    rlogin = setInterval("checkCookie()", 1000);
});

/* Refresh time setting (Refresh in rtime)*/

function setAutoReplace(time){
    rTime = time;
    if(rplc != null){
        clearInterval(rplc);
    }
    if(rTime != 0){
        rplc = setInterval("replaceData()", rTime*1000);
    }
}

/* In case of Refresh, call each data*/
function replaceData(){
    getTempLog();
    getDeviceState();
    getTemp();
}

function getTempLog(){
    if(!checkTypeSys(tempType, tempSystem)){
        alert("Check the type and display format (temperature value log)");
        return false;
    }
}

var pCommand = tempDevice+' 0 '+tempHex;
var pType = tempType;

```

```

$.ajax({
  type : 'GET',
  url : '/KR/read_device_data.cgi?pCommand='+pCommand+'&pType='+pType,
  dataType : "json",
  global: false,
  error:function(){
    alert("Access to the server has failed. Try it again.");
  },
  success:function(data){
    buff.unshift(data);
    var list = $('#temp_table_list');
    list.html("");
    var tr = "";
    while(buff.length > 20){
      buff.pop();
    }
    for(var i=0;i<buff.length;i++){
      tr += '<tr>';
      tr += '<td>'+(i+1)+'</td>';
      tr += '<td>'+buff[i].pDate+'</td>';
      tr += '<td>'+buff[i].pTime+'</td>';
      tr += '<td>'+checkType(tempSystem,buff[i].pValue,pType)+'</td>';
      tr += '</tr>';
    }
    list.html(tr);
  }
});
}

function getDeviceState(){
  if(!checkTypeSys(sysType, sysSystem)){
    alert("Check the type and display format (systemstate)");
    return false;
  }
  var pCommand = sysDevice+' 0 '+sysHex;
  var pType = sysType;

  $.ajax({
    type : 'GET',
    url : '/KR/read_device_data.cgi?pCommand='+pCommand+'&pType='+pType,
    dataType : "json",
    global: false,
    error:function(){
      alert("Access to the server has failed. Try it again.");
    },
    success:function(data){
      setDeviceView(data.pValue);
    }
  });
}

```

```

function setDeviceState(val){
    if(!checkTypeSys(sysType, sysSystem)){
        alert("Check the type and display format (systemstate)");
        return false;
    }
    $.ajax({
        type: 'POST',
        url: "/KR/set_plc_run.cgi",
        data: 'mode='+val,
        dataType: "text",
        error:function(){
            alert("Access to the server has failed. Try it again.");
        },
        success:function(data, code){
            var code = data.substr(0,3);
            if(code == '100'){
                setDeviceView(val);
            }
        }
    });
}

function setDeviceView(val){
    var addImg = "";
    if(val == '1'){
        addImg+=;

        if(uAuth == '0'){
            addImg+=<div style="width:50px; height:20px; float:left; padding: 4px 0px 0px
30px;">RUN</div> <input style="float:left;" type="button" value="stop" onclick="setDeviceState(0);">;
        }
        $("#state_image").html(addImg);
    }
    else if(val == '0'){
        addImg+=;

        if(uAuth == '0'){
            addImg+=<div style="width:50px; height:20px; float:left; padding: 4px 0px 0px
30px;">STOP</div> <input style="float:left;" type="button" value="operation" onclick="setDeviceState(1);">;
        }
        $("#state_image").html(addImg);
    }
    }else{
        addImg+=<div style="width:100%; height:20px; float:left; padding: 4px 0px 0px 30px;">알수없는 data
형식입니다.</div>;
        $("#state_image").html(addImg);
    }
}

function getTemp(){

```



```

if(!checkTypeSys(tempType, tempSystem)){
    alert("Check the type and display format (temperature value log)");
    return false;
}
var pCommand = tempDevice+' 0 '+tempHex;

$.ajax({
    type : 'GET',
    url : '/KR/read_device_data.cgi?pCommand='+pCommand+'&pType='+tempType,
    dataType : "json",
    global: false,
    error:function(){
        alert("Access to the server has failed. Try it again.");
    },
    success:function(data){
        var temp = checkType(tempSystem,data.pValue,tempType);
        var tMsg = "";
        if(temp >= -128 && temp <= -11){
            tMsg = 'warning: The temperature value is too low.';
        }else if(temp >= -10 && temp <= 40){
            tMsg = 'normal: The temperature value is normal.';
        }else if(temp >= 41){
            tMsg = 'warning: The temperature value is too high.';
        }else{
            tMsg = 'temperature : '+temp;
        }
        document.getElementById("temp_state").innerHTML = tMsg;

        tempPer = checkValuePercentage(tempType,tempSystem,temp+");
        document.getElementById("dev_progress_bar").style.width = tempPer+'%';
        document.getElementById("dev_progress_bar_value").innerHTML = temp+'degree';
        document.getElementById("conf_temp").value = temp;
    }
});
}

```

```

function setTemp(){
    if(!checkTypeSys(tempType, tempSystem)){
        alert("Check the type and display format (temperature value log)");
        return false;
    }
    var tempValue = document.getElementById("conf_temp").value;
    if(!checkValueLength(tempHex,'1',tempValue)){
        return;
    }
    var sData = "";
    var hexVal = decimalToHexString(tempValue, tempHex);
    sData += 'pCommand='+Base64.encode(tempDevice+' 1 '+tempHex);
    sData += '&pType='+tempType;
    sData += '&pValue='+hexVal;

```

```

$.ajax({
    type : 'POST',
    url : '/KR/write_device_data.cgi',
    dataType : "text",
    data:sData,
    error:function(){
        alert("Access to the server has failed. Try it again.");
    },
    success:function(data){
        var code = data.substr(0,3);
        if(checkParameter(code)){
            if(code == '100'){
                alert('Registered. ');
            }else{
                alert("Access to the server has failed. Try it again.");
            }
            getTemp();
        }
    }
});
}

function loadLogin(){
    if(get_cookie("LSID") != null){
        uAuth = parseInt(get_cookie("AUTH"));
        var auth = "";
        if(uAuth == '0'){
            auth = 'administrator';
        }else if(uAuth == '1'){
            auth = 'general';
        }else{
            auth = uAuth;
        }
        var user_view = document.getElementById("user_view");
        user_view.firstChild.firstChild.innerHTML = get_cookie("LSID")+ ' (+auth+) <input type="button"
value="logout" onclick="logout()">';
        document.getElementById("login_layer").style.display = 'none';
        setAutoReplace(rTime);
        replaceData();
    }else{
        document.getElementById("login_layer").style.display = 'block';
    }
}

function login(){
    var id=document.getElementById('pAccout');
    var pw=document.getElementById('pPasswd');
    if(!checkParameter(id.value)){
        alert('Input the account');
    }
}

```

```

    }else if(!checkParameter(pw.value)){
        alert('Input the password');
    }else{
        /*
        MD5(password).toUpperCase()

        - login encrypted module

        */
        var sData = 'pAccount='+id.value+'&pPassword='+MD5(pw.value).toUpperCase();
$.ajax({
    type : 'POST',
    url : '/KR/login.cgi',
    data : sData,
    dataType : "json",
    error:function(){
        alert("Access to the server has failed. Try it again.");
    },
    success:function(data){
        if(data.pCode == 100){
            uAuth = data.pAuth;
            var user_view = document.getElementById("user_view");
            pw.value = "";
            var auth = "";
            if(data.pAuth == '0'){
                auth = 'administrator';
            }else if(data.pAuth == '1'){
                auth = 'general';
            }else{
                auth = data.pAuth
            }
            user_view.firstChild.firstChild.innerHTML = data.pAccount+' ('+auth+') <input
type="button" value="logout" onclick="logout()">;
            document.getElementById("login_layer").style.display = 'none';
            setAutoReplace(rTime);
            replaceCookie(data.pAccount,data.pAuth);
            replaceData();
        }else if(data.pCode == 101){
            alert("Check the account and password.");
        }
    }
});
}

function logout(){
$.ajax({
    type : 'GET',
    url : '/KR/logout.cgi',

```

```

        dataType : "text",
        error:function(){
            alert("Access to the server has failed. Try it again.");
        },
        success:function(data){
            deleteCookie();
            var code = data.substr(0,3);
            if(checkParameter(code)){
                if(code == '100'){
                    document.getElementById("login_layer").style.display = 'block';
                    document.getElementById("user_view").firstChild.firstChild.innerHTML = "";
                    uAuth = 0;
                    clearInterval(rplc);
                }else if(code == '101'){
                    alert("Access to the server has failed. Try it again.");
                }
            }else{
                alert("Access to the server has failed. Try it again.");
            }
        }
    });
}
</script>
</head>

<body>
<div id="login_layer" style="position: fixed; width: 100%; height:100%; background-color: white; z-index: 10000;">
    <div id="login_bg" style="margin:200px auto; width:250px; height:auto;">
        <table id="login_view">
            <tr>
                <th>account : </th>
                <td><input id="pAccout" type="text"></td>
            </tr>
            <tr>
                <th>password : </th>
                <td><input id="pPasswd" type="password"></td>
            </tr>
            <tr>
                <th></th>
                <td><input style="float:right;" type="button" value="login" onclick="login()"></td>
            </tr>
        </table>
    </div>
</div>

<div class="main_top" style="position:relative; top:0px; width:100%; height:50px; padding:0; border-bottom: 1px solid blue;">
    <span class="top_left" onclick="javascript:window.open('http://www.ls-electric.com');"><div class="div_t"><div class="div_c">LS
    ELECTRIC homepage</div></div></span>
    <span class="top_left" onclick="javascript:window.open('http://www.ls-electric.com/ls/support/downloadlist.asp');"><div
    class="div_t"><div class="div_c">manual download</div></div></span>

```

```

    <span id="user_view" style="" class="top_right"><div class="div_t"><div class="div_c"></div></div></span>
</div>
<div style="position:relative; top:0px; width:100%; height:500px;">
    <div style="position:absolute; top:0; left:0; width:190px; background-color: blue; color:white; padding:           10px;
    bottom:0px;">
        <ul style="list-style: none; padding:0px;">
            <li
onclick="document.getElementById('dev_list').style.display='none';document.getElementById('dev_State').style.display='block';">1.tem
perature control system control</li>
            <li
onclick="document.getElementById('dev_list').style.display='block';document.getElementById('dev_State').style.display='none';">2.tem
perature value log</li>
        </ul>
    </div>
    <div id="dev_top" style="position: absolute; top:0px; left:210px; right: 0px; height:40px;">
        <select onChange="setAutoReplace(this.value);" style="position: absolute; top:10px; right: 10px;">
            <option value="10">10 seconds</option>
            <option value="20">20 seconds</option>
            <option value="30">30 seconds</option>
            <option value="60">1 minute</option>
        </select>
    </div>
    <div id="dev_State" style="position: absolute; top:40px; left:210px; right: 0px; bottom:0px;">
        <table class="main_state" style="position:absolute; top:15px; left:15px;width:400px;">
            <tr>
                <th>system</th>
                <td id="state_image" style="position: relative;"></td>
            </tr>
            <tr>
                <th>state</th>
                <td id="temp_state">normal : The temperature value is normal.</td>
            </tr>
            <tr>
                <th>현재 temperature</th>
                <td>
                    <div style="width:220px; height:18px;"></div>
                    <div style="width:220px; height:20px; border:1px solid black; padding:2px;">
                        <div id="dev_progress_bar" style="background-color:blue; width:30%; height:100%;"></div>
                        </div>
                        <div id="dev_progress_bar_value" style="width:220px; text-align: center; font-weight: bold;">30도</div>
                    </td>
            </tr>
            <tr>
                <th>setting temperature</th>
                <td><input id="conf_temp" type="text">degree <input type="button" value="change" onclick="setTemp()"></td>
            </tr>
        </table>
    </div>
    <div id="dev_list" style=" display:none; position: absolute; top:0px; left:210px; right: 0px; bottom:0px;">
        <div class="list_table" style="position: absolute; top:40px; left:10px; right: 10px;">

```

```

        <div class="table_header">
<table cellspacing="0">
    <colgroup>
        <col width="20%">
        <col width="30%">
        <col width="30%">
        <col width="20%">
    </colgroup>
    <thead>
<tr>
    <th scope="col">No.</th>
    <th scope="col">date</th>
    <th scope="col">time</th>
    <th scope="col">value</th>
</tr>
    </thead>
</table>
</div>
<div class="table_list" style="height: 425px; max-height:auto;">
<table cellspacing="0">
    <colgroup>
        <col width="20%">
        <col width="30%">
        <col width="30%">
        <col width="20%">
    </colgroup>
    <tbody id="temp_table_list">
    </tbody>
</table>
</div>
</div>
</div>
</div>
</body>
</html>

```

Appendix 4.3.2 Instructions for Setting

- 1) Paste the sample code to the note pad.
- 2) Input the name, type and display format of the device to read or write to the **'Temperature value log'** area of the sample code.
- 3) Input the F00000(%FX0) system flag parameter that enables you to check the PLC's operating state such as RUN or STOP to the **'system state'** area of the sample code.
- 4) After inputting parameters, click the File - 'Save as' button in the note pad menu.
- 5) After setting **filename: home.html, file format: all files, encoding: UTF-8** in [Fig. 4.2.1.2] 'Save as' window, click the 'Save' button
- 6) After saving the file, log in to the web server with the administrator privilege.
- 7) Move to Setting-User page and click the 'Select File' button.

- 8) If you select the saved 'home.html' file and click the 'Open' button, the file will be transferred to the web server.
- 9) After file transfer is done, input the below URL to the web page.
 - **http://xxx.xxx.xxx.xxx/userpage/home.html**
 - **xxx.xxx.xxx.xxx means** the web server's IP.
- 10) If you load the web page by entering the URL, [Fig. 4.3.1] temperature control system page will be loaded.

Appendix 4.3.3 How to use

- 1) Load [Fig. 4.3.1] temperature control system page.
- 2) If it does not log in to the web server, [Fig. 4.3.2.1] login page will pop up.



The image shows a login form with two input fields. The first field is labeled 'ID :' and the second is labeled 'Password :'. To the right of the password field is a button labeled 'Login'.

[Fig. 4.3.2.1] Login page

- 3) Enter the account and password registered in the web server setting to the login page and then, press the login button.
- 4) If you press the button, [Fig. 4.3.1] temperature control system page will be loaded.
- 5) In [Fig. 4.3.1] temperature control system page, you can change the PLC's operating state by clicking the RUN or STOP button. If you input the targeted value to the set temperature and press the 'Change' button, you can see the value will be changed. You can also see the system's state and temperature display will be changed according to the set temperature.
- 6) If you click '2.temperature value log' at the top left corner of [Fig. 4.3.1] temperature control system page, [Fig. 4.3.2] temperature value log page will be loaded.
- 7) In [Fig. 4.3.2] temperature value log page, you can see the temperature value set in the temperature control system page will be input to the list based on the set cycle.

Notice

(1) If you click the user page button of the basic page, the user page is also available. For more details, refer to the web server manual.

Appendix 5 PLC update using SD

This chapter explains how to update the PLC project / OS using the SD card.

Appendix 5.1 Overview

XGB high performance compact PLC provides PLC OS and project update function using SD memory card, not direct connection of XG5000.

Notice

The PLC update function using the SD card is supported from PLC version 1.40 or later and products manufactured after March 2016.

Appendix 5.1.1 Features

XGB high performance compact PLCs can be used to update OS / projects using commercially available SD memory cards. The main features of the PLC update function using the SD card are as follows.

- 1) card setting function for PLC update
 - SD card can be set to update using XG5000.

- 2) PLC OS update using SD card
 - Upgrading / downgrading PLC OS using SD memory
 - Update can be limited if the PLC version is higher version

- 3) PLC project update using SD card
 - PLC program leak prevention by password setting
 - Restrict execution of update using device unique address
 - PLC auto reset and operation mode can be set after updating

Appendix 5.1.2 Names of Parts

The names of each part to perform PLC update function are as follows.

(1) Name of each part

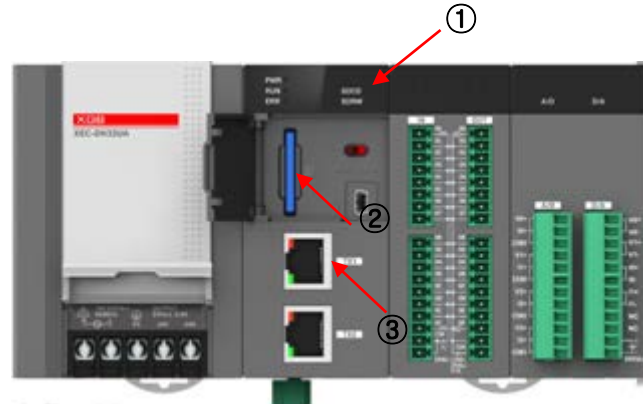

	Name	Description
①	Status LED	Displays the SD memory operation status.
②	SD memory mounting slot	The slot into which the SD memory is mounted.
③	Built-in Ethernet Port	It is used to update PLC via web server.

(2) LED indication



Name	Description	Operation specification
RUN	It shows the operation status of high performance XGB PLC.	ON at RUN, OFF at ERR, ERR
ERR	The error occurrence status of high performance XGB series PLC is displayed.	Flashes when an error occurs
STATE	The status of the installed SD memory card is displayed.	Lit: SD card installed, normal status, updating PLC Flashing: error status (1s cycle), completes PLC update Off: SD card removed
RD/WR	Indicates the SD card control status.	Blinking: SD card reading or writing (50ms cycles) Off: SD card access is suspended

Appendix 5.2 Specifications

Appendix 5.2.1 Specification for SD Update

1) PLC OS / Project Update Function Available Version

Product Content	PLC OS / Project Update Available Versions
XG5000	4.05 or higher
XBC-xxxxUx	1.30 or higher
XEC-xxxxUx	1.30 or higher
Boot loader	1.1 or higher (* Products manufactured after October 2015 are available Please contact a service representative when using an older product)

2) Project update not supported module

- Products that store separate parameters in individual modules without storing parameters in basic units

Module name	Type name	Description
Special Module	XBF-PD02A	Positioning 2-axis (line drive), maximum output 2Mbps
	XBF-TC04RT	Temperature control module (RTD temperature input type, 4 loops)
	XBF-TC04TT	Temperature control module (TC temperature input type, 4 loops)
Communication module	XBL-CMEA	CANopen Master 1Ch
	XBL-PMEC	Profibus-DP, Master

Appendix 5.2.2 Updatable Areas via SD

1) OS

- PLC main OS upgrade

2) project

- User program
- Basic / IO / Built-in Parameters
- Communication parameters
- TB (Task Block) / PB (Program Block) table

3) Other

- PLC password
- Link Enable Information
- PLC read protection setting (XBC: Program read protection setting / XEC: Save as binary file)

Appendix 5.3 Operating Specifications

Appendix 5.3.1 SD card setting for PLC update

1) Export to SD card

(1) Preparing SD card for PLC update

If you execute [XG5000] – [PROJECT] – [Edit SD Card] – [Export to SD card], the window for setting the SD card is displayed. (SD card export function is available only when XG5000 is not online.)

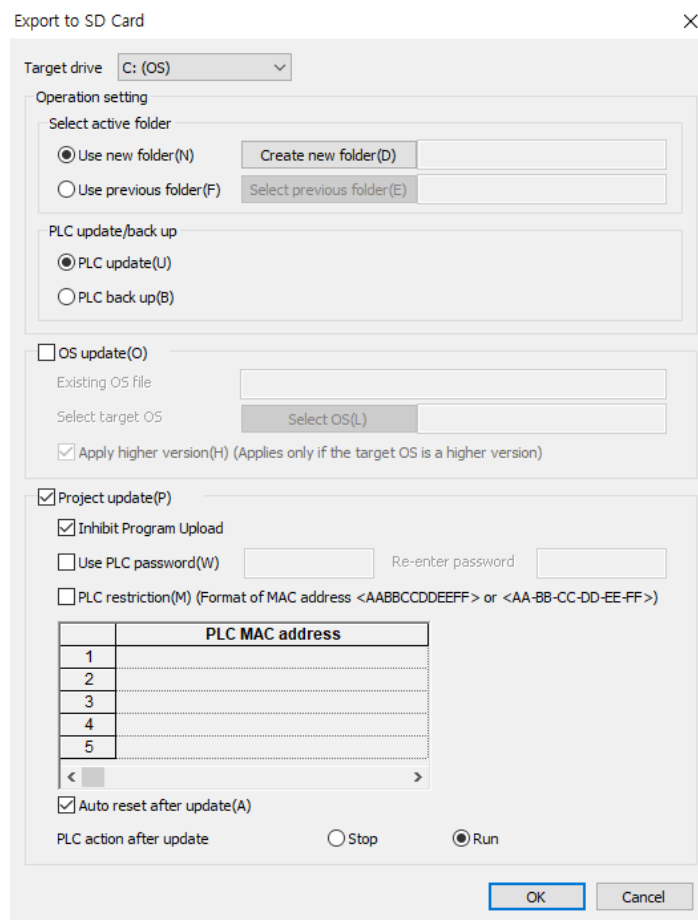

[Figure] Export to SD card function window

A description of each item follows.

Classification	Description
Target drive	Select storage medium to save OS, project data
Select Action Folder	Location to save OS, project data (folder)
PLC update / backup	PLC operation setting when inserting SD card PLC update: update the PLC with data stored on the SD card PLC backup: save PLC project to SD card
OS update	Whether to perform PLC OS update using SD card
OS copied to SD card	OS file information on the selected action folder
Select target OS to copy	Information of OS files to copy to SD card
Apply higher version	Applies to the higher of PLC OS version and OS version saved in SD card
Project update	Whether to perform PLC project update using SD card

Prohibit reading from PLC	Prohibit read from PLC when updating a PLC project using SD (XBC: Disable program read / XEC: Save as binary file)
Use PLC Password	Set PLC password, check whether the PLC project can be updated using SD
PLC usage restrictions	PLC project can be updated PLC designation
Auto reset after update complete	Whether to perform PLC reset after PLC update
PLC status after update	PLC operation mode setting after PLC update

(2) import from SD

(1) Open a project stored in SD

Export to SD allows you to check the PLC project saved in SD to XG5000.

If you execute [XG5000] – [PROJECT] – [Edit SD Card] – [Import from SD card], the window for setting the SD card is displayed.

The folder list view function button allows you to check the folder list where the PLC project is stored and select the desired folder to call up the PLC project stored in the SD card.

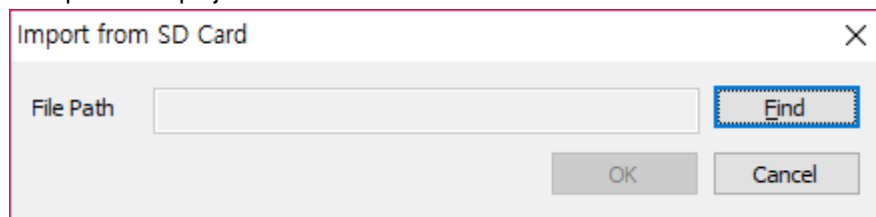

[Figure] Import from SD card window

A description of each item follows.

Classification	Description
File Path	Currently selected file information

- (1) When using the Export to SD function, the created file is saved even if the target drive is not an SD card slot.
- (2) If you use the Export to SD function instead of the SD card, you can use the SD update function in the same way by saving the created file in the root folder of the SD card.
- (3) If there is a project file that has been exported to SD in the storage, not the SD card, it is possible to import the project by using the Import from SD function.

Appendix 5.3.2 PLC Update via SD Card

If you insert the prepared SD card through the Export to SD card function described in 5.3.1 into the empty SD card slot of the PLC in the Stop state, the PLC is automatically updated.

The PLC update area and the status of the PLC after the update are set by the user through the Export to SD card function.

Notice

- (1) For PLC project update using the SD card, refer to Ver. Available after 1.30.
- (2) For PLC OS update using SD card, Ver. Available since 1.30, October 2015.
If you want to provide the function in the previous production PLC, please contact the customer center.
- (3) If the update function does not work even after removing and reinserting the SD card during the SD card update, please contact the designated dealer and reinstall the OS. (Flash OS can be reinstalled.)

Appendix 5.3.3 Confirmation of PLC update result using SD card

You can check the result of PLC update using SD through the system history tab of [XG5000] – [ONLINE] – [System Diagnostics] – [PLC History].

Occurrence history and details are as follows.

Classification	Description
Read project from SD, Complete	Project update complete
Read project from SD, fail, File validation error	Project data corruption
Read project from SD, fail, Damaged files	Project file error
Read project from SD, fail, Unsupported file version	Version Information Error in Project File
Read project from SD, fail, Model mismatch	CPU type mismatch
Read project from SD, fail, No password in file	PLC is password protected
Read project from SD, fail, Password mismatch	PLC password and file password mismatch
Read project from SD, fail, MAC address mismatch	Project Update PLC Limited
Read project from SD, fail, File decryption error	RLE Decode Fail (File Error)
Read project from SD, fail, IO configuration mismatch	Mismatch between project IO configuration of SD card and PLC
Read project from SD, fail, SD card detachment	SD putting on and taking off while reading data from SD card
OS update from SD, Complete	OS update complete
OS update from SD, fail, Unsupported Boot Loader	Old Boot Loader Does Not Support Updates
OS update from SD, fail, File OS is a lower version	Restrict Updates by Applying Higher Version Options
OS update from SD, fail, SD card detachment	SD putting on and taking off while reading data from SD card
OS update from SD, fail, OS file is abnormal (model mismatch)	Mismatch between SD card and PLC OS
SD card check required	Script file does not meet specifications
Read project from web server, Complete	Project update complete
Read project from web server, fail, File validation error	Project data corruption
Read project from web server, fail, Damaged files	Project file error
Read project from web server, fail, Unsupported file version	Version Information Error in Project File
Read project from web server, fail, Model mismatch	CPU type mismatch
Read project from web server, fail, No password in file	PLC is password protected
Read project from web server, fail, Password mismatch	PLC password and file password mismatch
Read project from web server, fail, MAC address mismatch	Project Update PLC Limited
Read project from web server, fail, File decryption error	RLE Decode Fail (File Error)
Read project from web server, fail, IO configuration mismatch	Mismatch between project IO configuration of SD card and PLC
OS update from web server, Complete	OS update complete
OS update from web server, fail, Unsupported Boot Loader	Old Boot Loader Does Not Support Updates
OS update from web server, fail, OS file is abnormal (model mismatch)	Update OS file and PLC OS model do not match

Warranty

Warranty

1. Warranty Period

The product you purchased will be guaranteed for 18 months from the date of manufacturing.

2. Scope of Warranty

Any trouble or defect occurring for the above-mentioned period will be partially replaced or repaired. However, please note the following cases will be excluded from the scope of warranty.

- (1) Any trouble attributable to unreasonable condition, environment or handling otherwise specified in the manual,
- (2) Any trouble attributable to others' products,
- (3) If the product is modified or repaired in any other place not designated by the company,
- (4) Due to unintended purposes
- (5) Owing to the reasons unexpected at the level of the contemporary science and technology when delivered.
- (6) Not attributable to the company; for instance, natural disasters or fire

3. Since the above warranty is limited to PLC unit only, make sure to use the product considering the safety for system configuration or applications.

Environmental Policy

LS ELECTRIC Co.,Ltd. supports and observes the environmental policy as below.

Environmental Management

LS ELECTRIC considers the environmental preservation as the preferential management subject and every staff of LS ELECTRIC use the reasonable endeavors for the pleasurable environmental preservation of the earth.

About Disposal

LS ELECTRIC' PLC unit is designed to protect the environment. For the disposal, separate aluminum, iron and synthetic resin (cover) from the product as they are reusable.



www.ls-electric.com

LS ELECTRIC Co., Ltd.

■ Headquarter

LS-ro 127(Hogye-dong) Dongan-gu, Anyang-si, Gyeonggi-Do, 14119, Korea

■ Seoul Office

LS Yongsan Tower, 92, Hangang-daero, Yongsan-gu, Seoul, 04386, Korea

Tel: 82-2-2034-4033, 4888, 4703 Fax: 82-2-2034-4588

E-mail: automation@ls-electric.com

■ Overseas Subsidiaries

• LS ELECTRIC Japan Co., Ltd. (Tokyo, Japan)

Tel: 81-3-6268-8241 E-Mail: japan@ls-electric.com

• LS ELECTRIC (Dalian) Co., Ltd. (Dalian, China)

Tel: 86-411-8730-6495 E-Mail: china.dalian@lselectric.com.cn

• LS ELECTRIC (Wuxi) Co., Ltd. (Wuxi, China)

Tel: 86-510-6851-6666 E-Mail: china.wuxi@lselectric.com.cn

• LS ELECTRIC Middle East FZE (Dubai, U.A.E.)

Tel: 971-4-886-5360 E-Mail: middleeast@ls-electric.com

• LS ELECTRIC Europe B.V. (Hoofddorp, Netherlands)

Tel: 31-20-654-1424 E-Mail: europartner@ls-electric.com

• LS ELECTRIC America Inc. (Chicago, USA)

Tel: 1-800-891-2941 E-Mail: sales.us@lselectricamerica.com

• LS ELECTRIC Turkey Co., Ltd.

Tel: 90-212-806-1225 E-Mail: turkey@ls-electric.com

■ Overseas Branches

• LS ELECTRIC Tokyo Office (Japan)

Tel: 81-3-6268-8241 E-Mail: tokyo@ls-electric.com

• LS ELECTRIC Beijing Office (China)

Tel: 86-10-5095-1631 E-Mail: china.auto@lselectric.com.cn

• LS ELECTRIC Shanghai Office (China)

Tel: 86-21-5237-9977 E-Mail: china.auto@lselectric.com.cn

• LS ELECTRIC Guangzhou Office (China)

Tel: 86-20-3818-2883 E-Mail: china.auto@lselectric.com.cn

• LS ELECTRIC Chengdu Office (China)

Tel: 86-28-8670-3201 E-Mail: china.auto@lselectric.com.cn

• LS ELECTRIC Qingdao Office (China)

Tel: 86-532-8501-2065 E-Mail: china.auto@lselectric.com.cn

• LS ELECTRIC Nanjing Office (China)

Tel: 86-25-8467-0005 E-Mail: china.auto@lselectric.com.cn

• LS ELECTRIC Bangkok Office (Thailand)

Tel: 66-90-950-9683 E-Mail: thailand@ls-electric.com

• LS ELECTRIC Jakarta Office (Indonesia)

Tel: 62-21-2933-7614 E-Mail: indonesia@ls-electric.com

• LS ELECTRIC Moscow Office (Russia)

Tel: 7-499-682-6130 E-Mail: info@lselectric-ru.com

• LS ELECTRIC America Western Office (Irvine, USA)

Tel: 1-949-333-3140 E-Mail: america@ls-electric.com

Disclaimer of Liability

LS ELECTRIC has reviewed the information in this publication to ensure consistency with the hardware and software described. However, LS ELECTRIC cannot guarantee full consistency, nor be responsible for any damages or compensation, since variance cannot be precluded entirely. Please check again the version of this publication before you use the product.

© LS ELECTRIC Co., Ltd 2015 All Right Reserved.

2022.10