

Top 100
Global
Innovator
for 10 years

Drive for Lift Application

L100

3-phase 380~440V 5.5~22kW



LS ELECTRIC

Contents

- 04 Features
- 08 Application
- 10 System Configuration
- 11 Model & Type
- 12 Specifications
- 14 Wiring
- 15 Main Power Terminal
- 16 Control Power Terminal
- 18 Auxiliary Power Terminals
- 18 LED for Status Display
- 19 Dimensions
- 20 Options
- 26 Peripheral Devices



Lift Drive **new** L100



Optimization



Responsibility



Compact



Convenience



L100 series, the optimal solution for lifting applications

L100 series, the optimal solution for lifting applications

Optimized for elevators and load lifting operation, the LS ELECTRIC L100 series offers best-in-class performance.

With size-optimized solutions for these applications, the L100 provides essential functions and options, which further enhance customer value.

Lift Drive L100

Size reduction and performance enhancement.

Compact but powerful!

A competitive solution for your applications.

Size Reduction
53%



Enhanced Performance **UP**
Reduced Size **DOWN**



Compact

Along with performance enhancement, size was reduced by applying heat dissipation analysis and utilising a 3D design process.

Best-in-class size competitiveness

- 47% size level compared to iV5
- Half-sized compared to other company products (5.5/7.5kW, m3)



Optimization

L100 series provides powerful performance and optimal functions for elevator and lift systems.

Premium High Performance Vector Control

Selectable IM/PM loads

Optimal control algorithm (Voltage/Speed/Flux) for smooth and precise operation

Save your commissioning time through optimal Auto-tuning and convenient Gain tuning

Essential Functions for Elevator operation

- Creepless optimal speed pattern (when Elevator IO applied)
- Anti-Rollback control without Load Cell feedback
- Optimal Load Cell compensation control for Anti-Rollback
- Emergency rescue operation by battery in case of power failure
- Auto Light Load Search function
- Short Floor operation pattern
- Elevator IO makes your elevator control system simple
- Anti Hunting Regulator function

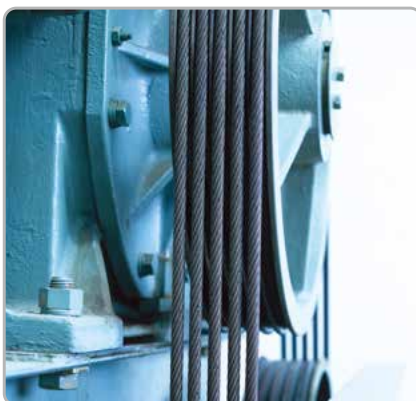



Responsibility

Designed for excellent environmental resistance.
Built-in safety function.

Built-In EMC Filter

- 1st Environment / Category C2 (Class B) CE

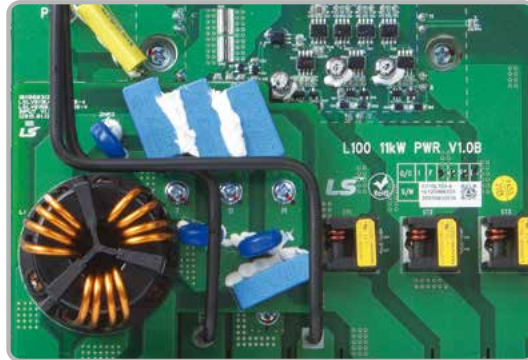

Built-In Safety (SIL 2)

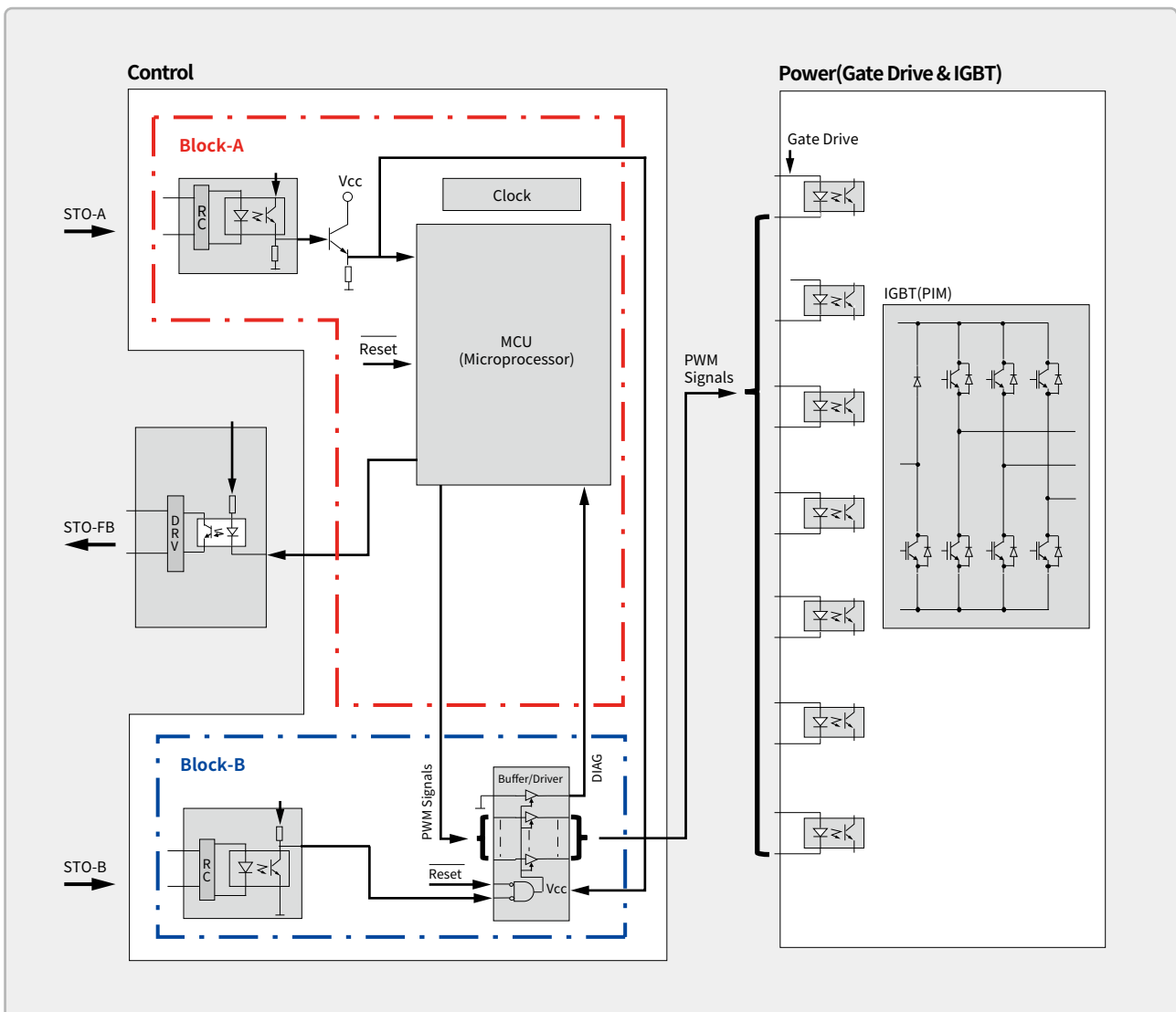



Convenience

Various features enhance user convenience in installation, commissioning and maintenance.

- Status LED for operation monitoring
- Easy LCD keypad (option) connection through front slide door
- Built-in dynamic brake circuit
- Removable terminal for easy maintenance
- DriveView9 support
- Built-in communication: CAN2.0B, RS-232C
- Simultaneous control of 8 L100 units via CAN communication
- DC Reactor connector
- Easy replacement of cooling fan



Scan QR code to access the manual.

Application

L100 series are optimized for elevator and lift operation with various encoder and elevator I/O options.



Incremental Encoder

- Incremental A/B Pulse
- Power: DC5V/12V/15V supply
- Input: A+[PA], A-, B+[PB], B-
- Output: RA, RB, RG (Encoder A, B phase return pulse)
- Support Encoder: Line Drive (+5V), Open Collector (+12V, +15V), Complementary



EnDat Encoder

- HEIDENHAIN Encoder (EnDat v2.2)
- Power: DC5V supply
- Input: SIN+, SIN-, COS+, COS-, DATA+, DATA-, CLK+, CLK-
- Output: RA, RB, RG
- Support Encoder: ECN413, ECN1313, ERN487, ERN1387



Elevator

- Precision control through SIN/COS encoder
- E/L master function via onboard option
- Optimal speed pattern generation / No creep speed
- Optimal Load Cell compensation
- Elevator I/O (ELIO) option
- Geared/gearless E/L operation
- Battery operation in case of power failure



Automatic warehouse parking facility

- Built-in brake control function
- Powerful load balance function
- Dedicated DB Unit provided
- Zero speed control function
- Precision control through SIN/COS encoder



SIN/COS Encoder

- HEIDENHAIN Encoder
- Power: DC5V supply
- Input: SIN+, SIN-, COS+, COS-, SIN2+, SIN2-, COS2+, COS2-
- Output: RA, RB, RG
- Support Encoder: ECN413, ECN1313, ERN487, ERN1387

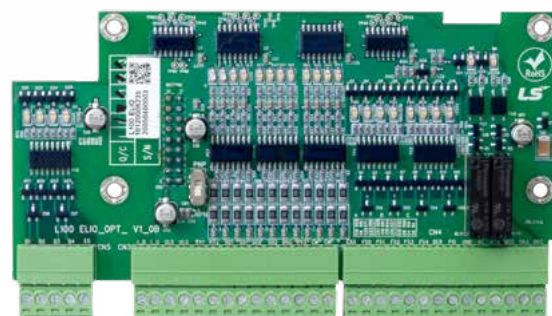



Elevator I/O (ELIO)

- Dedicated to elevator I/O terminal
- Digital input: 9 points for the elevator car control (photo-coupler isolation, PNP/NPN input mode)
- Digital output: 10 points for the position of the elevator car and operation control (isolated open collector 8 points, relay A (NO) 2 points)
- Fault information output: 4 points (isolated open collector)

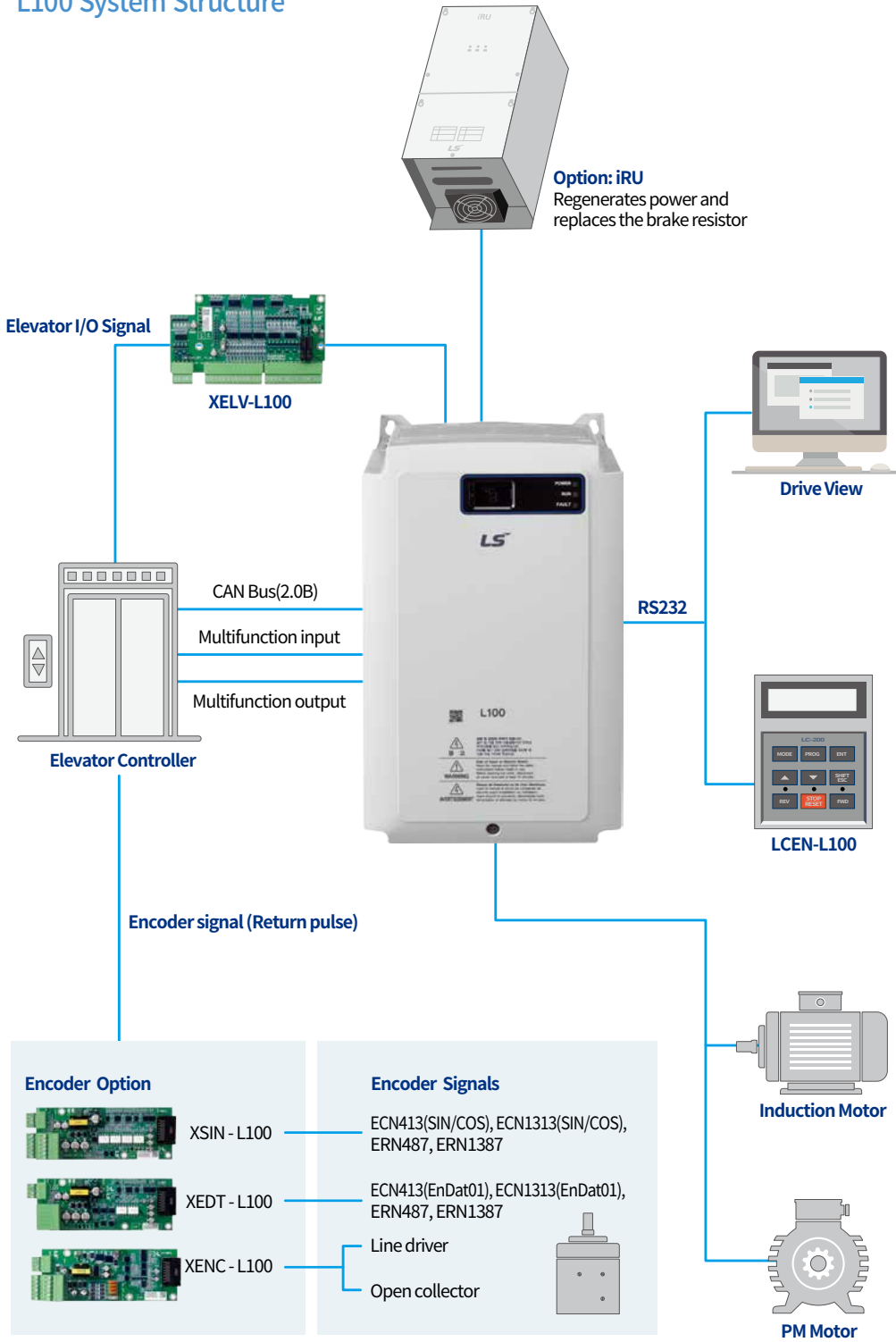
L100 System Structure



Drive Nameplate

Model Name	LSLV0075L100-4NNFN				 
Input Power Specifications	INPUT	380-480V	3 Phase	50/60Hz	
Output Power & Speed	OUTPUT	0-Input V	3 Phase	0-3600rpm	
Rated Output Current	16A				
Rated Output Capacity	10HP / 7.5kW (D)				
Serial No.	Ser. No 550292601CC				
	 Inspected by H.S.LEE R-R-LSR-XXXXXXX XXXXXXXX				

Drive Model Name

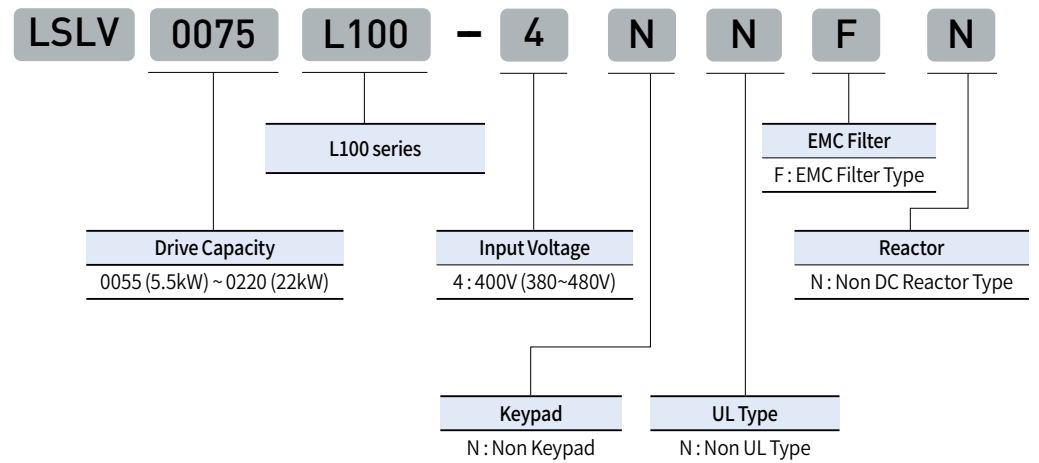



5.5~7.5kW

11~15kW

18.5~22kW

LSLV□□□□L100-4NNFN		0055	0075	0110	0150	0185	0220
Motor ^{Note 1)}	[HP]	7.5	10	15	20	25	30
	[kW]	5.5	7.5	11	15	18.5	22
Rated Output	Capacity[kVA] ^{Note 1)}	9.1	12.2	18.3	22.9	29.7	34.3
	Current[A]	12	16	24	30	39	45
	Speed	Induction motor: 0~3600[RPM], Synchronous motor: 0~680[RPM]					
	Voltage	0~380(480V ^{Note 2)})					
Rated Input	Voltage	3 phase 380-480V (-10% ~ +10%) ^{Note 3)}					
	Frequency	50 ~ 60 Hz(±5%)					
	Current[A]	12.9	17.5	26.5	33.4	43.6	50.7
Weight[kg (lbs)]		3.3 (7.3)	3.4 (7.5)	4.6 (10.2)	4.8 (10.6)	7.5 (16.6)	8.0 (17.7)

Note1) The rated motor capacity is based on a standard 4-pole motor. 400 V inverters are designed for a 440 V supply voltage.

Note2) The maximum output voltage cannot exceed the input voltage.

Note3) If the input voltage is greater than 480 V, apply input voltage derated by 10% from the rated input voltage. Also, install an AC reactor in the power input side if the voltage imbalance between the phases is greater than 2%.
[Voltage imbalance [%] = Max voltage [V] - Min voltage [V] / Three-phase average voltage [V] x 67 (IEC 61800-3 (5.2.3)]

Item		Description	
Circuit system		Voltage type inverter with IGBT	
Control	Control method	Induction motor (IM)	- Speed (sensored) - V/F control - Slip compensation
		Synchronous motor (PM)	Speed(Sensored)
	Speed control	Induction motor (IM)	Analog settings: ± 0.1 % (25 ±10°C) of max speed (1800 rpm) Digital settings: ± 0.1 % (0-40°C) of max speed (1800 rpm)
		Synchronous motor (PM)	Analog settings: ± 0.1 % (25 ±10°C) of max speed (680 rpm) Digital settings: ± 0.015 % (0-40°C) of max speed (680 rpm)
	Speed setting resolution	Analog settings: ± 0.1 % of max speed Digital settings: 0.1 rpm	
	Speed control response speed	50Hz	
	Overload capacity	Rated current: 150%, 1 min.	
Acceleration /Deceleration	Time settings	0.00-600.0 sec	
	Combination	4 acceleration/deceleration time choices	
	Pattern	Linear, S-Curve	
Braking	Braking method	Resistance discharge braking	
	Braking torque	150%	
	Braking resistor	External braking resistor (installation required)	
Input	Speed configuration	- Digital settings via the keypad - Analog input settings	- Multistep configurations via terminal input - Speed control via optional add-on modules
	Analog input	2 channels (V1, I1) 0 → 10 V, 10 → 0 V, -10 → 10 V, 10 → -10 V 0 → 20 mA, 20 → 0 mA 2 choices for multifunction analog input: speed or torque bias	
	Terminal contact input	FX, RX, BX, RST, P1, P2, P3, P4, P5, P6, P7 Various functions may be assigned to multifunction input terminals (P1-P7).	
Output	Analog output	2 channels (AO1, AO2) -10 → 10 V, 10 → -10 V, 0 → 10 V, 10 → 0 V output Various multifunction analog output options	
	Terminal contact output	Multifunction terminal contact output: 4 channels (A1-C1, A2-C2, A3-C3, A4-C4) Fault terminal contact output: 1 channel (30A-30C, 30B-30C)	
Protective functions (Trip)		Over Current, Ground Fault, Over Voltage, Low Voltage, Over Load, Inv OLT, InvOver Heat, InvThem OP, ETthermal, External-B, Arm Short, Encoder Err, BX, Over Speed, COM Error, HW-Diag, EEP Error, FAN Error, BatRUN Fault, Input PO, Output PO, SpdDev Err, SAFETY A/B, A3 Safety, ADC Error, Flr/FHM Data, EnDat Error	
Protective functions (Alarm)		Fan alarm, Inverter overheat alarm, Overload alarm	
Working environment	Surrounding environment	Environment Level: 3C3(IEC60721-3-3) classifications (for SO2, H2S, CL, NO2) Indoors, prevent contact with direct sunlight and corrosive gases	
	Ambient temperature	14°F-104°F (-10°C-40°C, no icing)	
	Ambient humidity	Relative humidity less than 95% RH (no condensation)	
	Cooling type	Forced fan cooling structure	
	Protection structure	IP00	
	Operation altitude/oscillation	No higher than 3,280 ft (1,000 m). Less than 9.8 m/sec ² (1.0 G).	

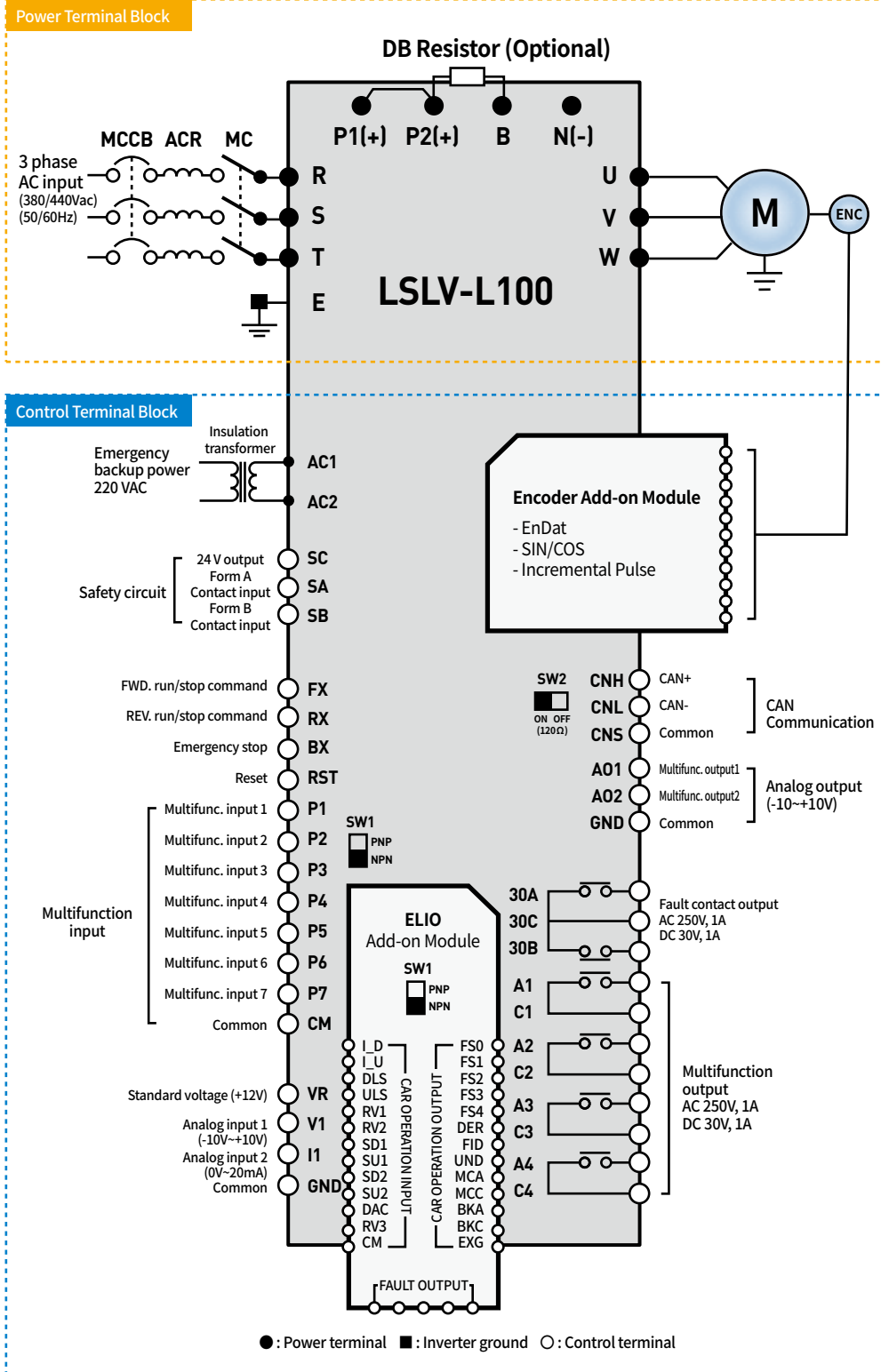

Main Power Terminal Arrangement

LSLV-L100 (5.5-22kW)

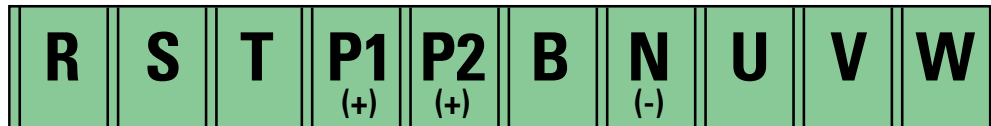

Main Power Terminal Descriptions

Terminal	Name	Description
R/S/T (L1/L2/L3)	AC power input terminals	3-phase AC power connection.
P1 (+)	DC link P(+) terminal	DC link wiring connections. (P1 and P2 terminals are jumped together when a DC reactor is not used)
P2(+)	DC link P(+) terminal	
N(-)	DC link N(-) connection	Common terminal for DC link connection
B	Brake resistor terminal	Brake resistor wiring connection. (Connect a brake resistor to P2 and B terminals)
U/V/W	Output terminals to motor	3-phase motor (induction motor, synchronous motor) wiring connections.



- Both P1 (+) and P2 (+) terminals are for DCP (+) connections.
- N (-) terminal is for DCN (-) connection. It is not a "neutral" contact.

Control Power Terminal Arrangement

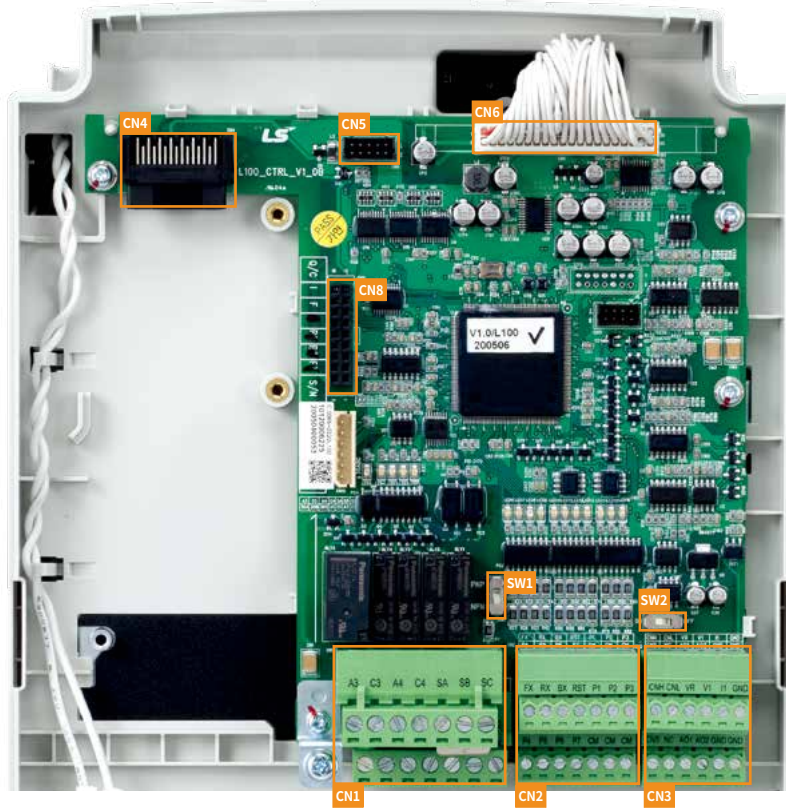

CN1 Terminal Descriptions

A3	C3	A4	C4	SA	SB	SC
30A	30B	30C	A1	C1	A2	C2

CN2 Terminal Descriptions

FX	RX	BX	RST	P1	P2	P3
P4	P5	P6	P7	CM	CM	CM

CN3 Terminal Descriptions

CNH	CNL	VR	V1	I1	GND
CNS	-	AO1	AO2	GND	GND

SW1 (PNP/NPN) Switch

SW2 (120Ω ON/OFF) Switch

Control Board Descriptions

Function	Label	Name	Description
Control board	CN1	Terminal output	Connector for fault relay (30A, 30B, 30C), multifunction terminal output (A1/C1 – A4/C4), and safety circuit terminal input (SA, SB, SC)
	CN2	Terminal input	Connector for digital terminal input: FX, RX, BX, RST, P1 – P7
	CN3	Analog I/O	Connector for analog terminal input (V1, I1), analog terminals output (AO1, AO2), and CAN communication
	CN4	Add-on module connector	Use this connector when using add-on module boards.
	CN5	Keypad connector	Connects to keypad.
	CN6	Power board connector	Connects to power board.
	CN8	ELIO add-on module connector	Use this connector when using ELIO add-on module boards.
	SW1 ^{Note 1)}	Digital input NPN/PNP selection switch	NPN/PNP mode selection switch Up: PNP, Down: NPN (default)
	SW2 ^{Note 2)}	Communication terminating resistor switch	For connecting the terminating resistor (120 Ω) when the inverter is connected to the end of communication node. Left: Terminating resistor ON Right: Terminating resistor OFF (default)

Note1) Refer to “Step 8 NPN/PNP mode selection for detailed information.

Note2) Refer to “Step 9 Setting terminating resistor” for detailed information.

Control Power
Terminal
Descriptions

Function	Label	Name	Description
CN2 Terminal input	FX	Forward operation/ stop command	In NPN input mode, operates when connected to CM terminal. When FX and RX are ON/OFF at the same time, the VFD stops.
	RX	Reverse operation/ stop command	
	BX	Emergency stop	In NPN input mode, triggered when connected to CM terminal and operates a free run stop or deceleration stop. It does not provide a fault signal.
	RST	Fault clearance	Fault status clears when the inverter is ON after the cause of the fault is removed.
	P1	Multifunction input terminals	<ul style="list-style-type: none"> - Configurable for the following multifunction inputs: - Multi speed operation L/M/H - Form B contact for external fault signal - Cancel soft start - ASR P/PI switching - Enable/disable max. torque - Enable/disable torque bias - Enable/disable battery operation - Disable low voltage trip detection
	P2		
	P3		
	P4		
	P5		
P6			
P7			
CM	COMMON	Common terminal for analog terminal input and output. - In NPN mode, function is ON when each multifunction terminal and CM terminal are connected. - In PNP mode, function is ON when an external 24 V power source is connected to CM terminal.	
CN1 Safety input	SA	Terminal for Safety Form A contact connection	Terminal for Safety Form A connection. Terminals SA and SC must be connected for inverter operation (disconnection triggers a protection feature).
	SB	Terminal for Safety Form B contact connection	Terminal for Safety Form BA connection. Terminals SB and SC must be connected for inverter operation (disconnection triggers a protection feature).
	SC	Safety 24 V power	24 V power supply for safety A/B connections.
CN3 Analog input	VR	Potentiometer for analog input	Maximum output voltage: +12 V / Potentiometer: 10 kΩ
	V1	Voltage input	Used for voltage input applications: -10→10 V, 10→-10 V, 0→10 V, 10→0 V
	I1	Current input	Used for current input applications: 0→20 mA, 20→0 mA
	GND	COMMON	Common terminal for analog terminal input.
CN3 Analog output	AO1	Analog output 1	Output voltage range: -10 V→10 V, 10 V→-10 V, 0 V→10 V, 10 V→0 V. Select one of the following: - Analog input value - Command before and after acceleration/deceleration - Speed control input command - Speed deviation - Speed control output - Forward direction torque limit - Torque limit during regeneration - Torque current command - Flux command - Flux current - D-axis current control output - Q-axis voltage - Output voltage - DC-link voltage
	AO2	Analog output 2	<ul style="list-style-type: none"> - Motor speed - Motor speed follow-up - Torque bias - Reverse direction torque limit - Torque command - Torque current - Flux current command - Q-axis current control output - D-axis voltage - Output current - Output power - Inverter temperature.
	GND	COMMON	Common terminal for analog terminal outputs
CN1 Multifunc- tion output	A1	C1 Multifunction output contact 1 (Form A contact)	<ul style="list-style-type: none"> Select one of the following: - Inverter operation available - Speed detection - Speed arrival - Timer output - In operation - Inverter overheat alert - Torque detection - Overload alert - MC output - ALLS status - Brake output
	A2	C2 Multifunction output contact 2 (Form A contact)	
	A3	C3 Multifunction output contact 3 (Form A contact)	
	A4	C4 Multifunction output contact 4 (Form A contact)	
	30A	Fault signal (Form A contact)	Output signal is generated when a fault occurs.
	30B	Fault signal (Form B contact)	Does not output when the emergency stop is activated.
	30C	COMMON	Common terminal for output contacts A and B.
CN3 Analog I/O (CAN I/O)	CNH	CAN HIGH	High, low, common signal terminals for CAN communication.
	CNL	CAN LOW	
	CNS	CAN COMMON	

The L100 inverter includes an auxiliary power terminal block. The auxiliary terminals enable the control board to operate without mains power (R/S/T) using auxiliary control power (220 V AC).

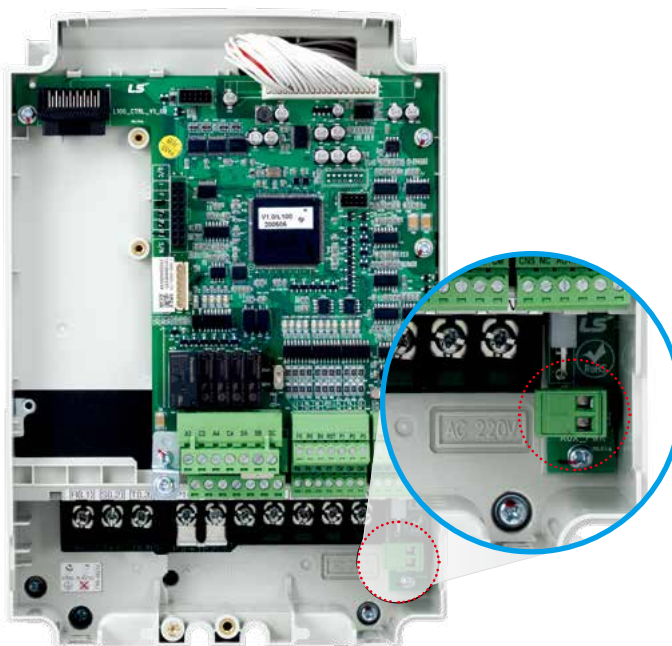

LSLV-L100 (5.5/7.5kW)

Descriptions

Label	Name	Description	Voltage
AC1, AC2	Auxiliary input voltage	Used to connect to single phase AC input voltage.	220V(-10 ~ +10%), 50/60Hz

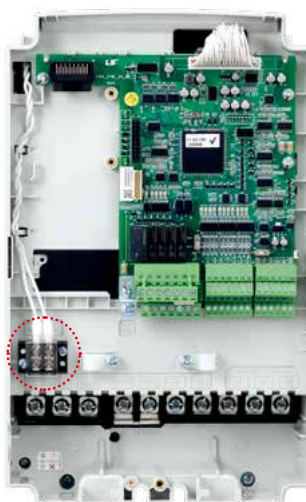

11/15kW

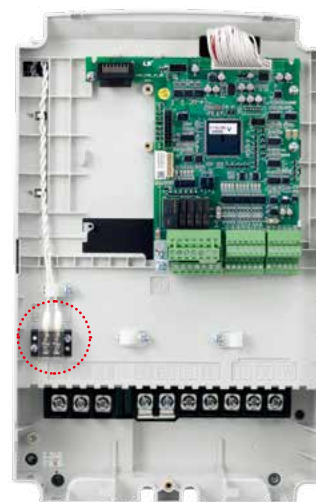

18.5/22kW

LED for Status Display

	Indicator	Color	Description
①	POWER	GREEN	Turns on when power is supplied to the control board.
②	RUN	BLUE	Turns on when power is supplied to the control board.
③	FAULT	RED	Flashes in 0.5 second intervals when the inverter operation is abnormal.



LSLV-L100 (5.5~22kW)

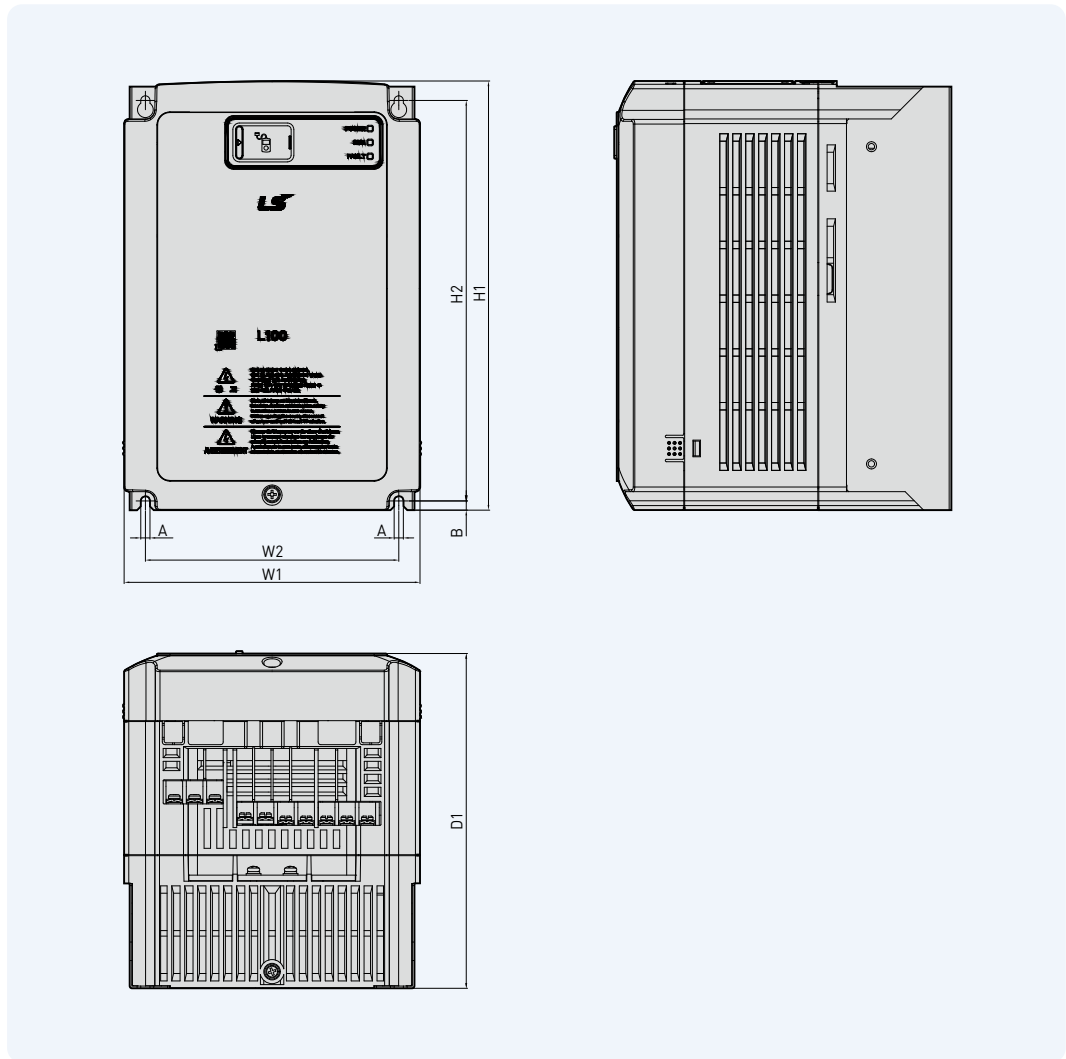

Drive Capacity	W1	W2	H1	H2	D1	A	B	mm (inches)
								Weight[kg (lbs)]
LSLV055L100-4	160	137	232	217	181	5	5	3.3 (7.3)
LSLV075L100-4	[6.30]	[5.39]	[9.13]	[8.54]	[7.16]	[0.20]	[0.20]	3.4 (7.5)
LSLV110L100-4	180	157	290	274	205	5	5	4.6 (10.2)
LSLV150L100-4	[7.09]	[6.18]	[11.42]	[10.79]	[8.07]	[0.20]	[0.20]	4.8 (10.6)
LSLV185L100-4	220	194	350	331	223	6	6	7.5 (16.6)
LSLV220L100-4	[8.66]	[7.64]	[13.78]	[13.78]	[8.78]	[0.24]	[0.24]	8.0 (17.7)

Incremental Encoder

For more information, please refer to the Incremental Encoder Option User Manual.

PCB Board and Terminals



CN2

5PE	12PE	15PE	GE	GE	GE
A+[PA]	A-	B+[PB]	B-	GE	GE

CN3

RA	RG	RB	RG
----	----	----	----

JP1 switch (LD/OC select)

- LD : Line Drive Type Encoder select
- OC : Open Collector (or Complementary) Type Encoder select

Terminal Descriptions

Item	Indication	Name	Description	
Encoder signal	Input pulse (CN2)	5PE	+5 V power	+5 V line drive power for encoder
		12PE	+12 V power	+12 V open collector power for encoder
		15PE	+15 V power	+15V open collector power for encoder
		GE	Ground	Ground for encoder power
		A+[PA] / A-	Encoder phase A signal	For a line drive encoder, connect output signal cables for phases A+ and A-. Open collector (or complementary) encoders utilize A+[PA] signals and GE.
		B+[PB] / B-	Encoder phase B signal	For a line drive encoder, connect output signal cables for phases B+ and B-. Open collector (or complementary) encoders utilize B+[PB] signals and GE.
	Output pulse (CN3)	RA	Encoder phase A return signal	Terminal for encoder phase A return signal
		RB	Encoder phase B return signal	Terminal for encoder phase B return signal
		RG	Ground	Ground for encoder return signals

- Note)**
- Comply with the encoder's power specifications when connecting the cables. Faulty cable connections may damage the encoder.
 - The LED indicator will flash in 1 second intervals if the cable connections and parameter settings are correct.

EnDat Encoder

For more information, please refer to the EnDat Encoder Option User Manual.

PCB Board and Terminals



CN2

5PE	5PE	GE	GE	SIN+	SIN-
COS+	COS-	DATA+	DATA-	CLK+	CLK-

CN3

RA	RG	RB	RG
----	----	----	----

Terminal Descriptions

Item	Indication		Name	Description
EnDat Encoder input (CN2)	5PE		Encoder power	+5 V encoder power
	GE			0V
	SIN+	SIN-	Encoder SIN signal	Encoder's SIN+/SIN- signal
	COS+	COS-	Encoder COS signal	Encoder's COS+/COS- signal
EnDat Communication (CN2)	DATA+	DATA-	Encoder data	Data input and output signals for receiving pole position data from the EnDat encoder. Used in ECN413 and ECN1313 encoders.
	CLK+	CLK-	Encoder clock	Clock signal for receiving data from the EnDat encoder. Used in ECN413 and ECN1313 encoders.
Encoder output (CN3)	RA		Encoder output phase A	Encoder A/B phase output signal Open collector output
	RB		Encoder output phase B	
	RG		Common output terminal	

Endat Specifications

Encoder type	ECN413(EnDat01 Note 1), ECN1313(EnDat01 Note 1), ERN487 Note 2 , ERN1387 Note 2
Encoder pulse numbers	2048

[Note1](#)) EnDat01 is HEIDENHAIN Ordering Code and support EnDat 2.2 interface.

[Note2](#)) When applying ERN series encoder in EnDat encoder option, set PAR_23 Enc Type to Sin/Cos_All and use only SIN/COS signal.

SIN/COS Encoder

For more information, please refer to the SIN/COS Encoder Option User Manual.

PCB Board and Terminals



CN2

5PE	5PE	GE	GE	SIN+	SIN-
COS+	COS-	SIN2+	SIN2-	COS2+	COS2-

CN3

RA	RG	RB	RG
----	----	----	----

Terminal Descriptions

Item	Indication	Name	Description	
SIN/COS Encoder input (CN2)	5PE	Encoder power	+5 V encoder power	
	GE		0V	
	SIN+	SIN-	Encoder SIN signal	Encoder's SIN+/SIN- signal
	COS+	COS-	Encoder COS signal	Encoder's COS+/COS- signal
	SIN2+	SIN2-	Encoder SIN2 signal	Encoder's SIN2+/SIN2- signal
COS2+	COS2-	Encoder COS2 signal	Encoder's COS2+/COS2- signal	
Encoder output (CN3)	RA	Encoder output phase A	Encoder A/B phase output signal Open collector output	
	RB	Encoder output phase B		
	RG	Common output terminal		

SIN/COS Specifications

Encoder type	ECN413(SIN/COS) ^{Note 1)} , ECN1313(SIN/COS) ^{Note 1)} , ERN487 ^{Note 1)} , ERN1387
Encoder pulse numbers	2048

Note1) When using the ECN series encoder in the SIN/COS encoder option, set PAR_23 Enc Type to 'Sin/Cos_All' and use only SIN/COS signals.

Elevator I/O Option

For more information, please refer to the Elevator I/O Option User Manual.

PCB Board and Terminals

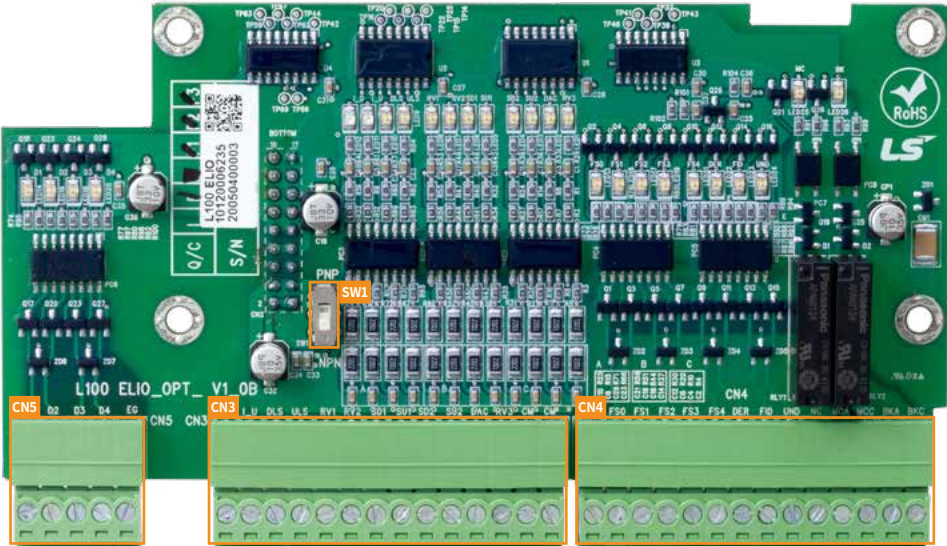

CN3

I_D	I_U	DLS	ULS	RV1	RV2	SD1	SU1	SD2	SU2	DAC	RV3	CM	CM
-----	-----	-----	-----	-----	-----	-----	-----	-----	-----	-----	-----	----	----

CN4

EXG	FS0	FS1	FS2	FS3	FS4	DER	FID	UND	NC	MCA	MCC	BAK	BKC
-----	-----	-----	-----	-----	-----	-----	-----	-----	----	-----	-----	-----	-----

CN5

D1	D2	D3	D4	EG
----	----	----	----	----

SW1 setting (PNP/NPN selection)

- PNP: Operates with an external 24 V power supply.
- NPN: Operates internally connected to CM. (Default: NPN)

Terminal Descriptions

Item	Indication	Name	Description																																																																																									
Elevator terminal input	I_D	Downside inductor signal	Downside inductor signal for detecting car position																																																																																									
	I_U	Upside inductor signal	Upside inductor signal for detecting car position																																																																																									
	DLS	Down Limit Switch	Car descent limit switch. Descending of a car is prohibited when the switch is turned on.																																																																																									
	ULS	Up Limit Switch	Car ascent limit switch. The car is prohibited from ascending when the switch is turned on.																																																																																									
	RV1	Reserved																																																																																										
	RV2	Reserved																																																																																										
	SD1	Downside Deceleration Switch 1	1st Deceleration Switch for forced deceleration while descending																																																																																									
	SU1	Upside Deceleration Switch 1	1st Deceleration Switch for forced deceleration while ascending																																																																																									
	SD2	Downside Deceleration Switch 2	2nd Deceleration Switch for forced deceleration while descending																																																																																									
	SU2	Upside Deceleration Switch 2	2nd Deceleration Switch for forced deceleration while ascending																																																																																									
	DAC	Deceleration approval signal	Deceleration approval signal for the controller																																																																																									
	RV3	Reserved																																																																																										
	CM	COMMON	Turned ON when each terminal input is connected to CM (24G).																																																																																									
Elevator terminal output	EXG	COMMON	Common ground for each terminal output.																																																																																									
	FS0	Requested floor for stop / current floor bit 0	Data format for requested floor for stop / current floor (Floors 1 – 32)																																																																																									
	FS1	Requested floor for stop / current floor bit 1	Bit4 Bit3 Bit2 Bit1 Bit0																																																																																									
	FS2	Requested floor for stop / current floor bit 2	FS4 FS3 FS2 FS1 FS0																																																																																									
	FS3	Requested floor for stop / current floor bit 3	Floor 1 : OFF OFF OFF OFF OFF																																																																																									
	FS4	Requested floor for stop / current floor bit 4	Floor 32 : ON ON ON ON ON																																																																																									
	DER	Signal for requesting deceleration approval	When this signal is input, the controller outputs the deceleration approval signal (DAC) if the requested floor for a stop matches the calling floor.																																																																																									
	FID	Floor identification signal	ON: Requested floor for a stop (previous floor), OFF: Current floor																																																																																									
	UND	Deceleration signal	Turns ON when the motor is decelerating.																																																																																									
	MCA/ MCC	Contact operation relay Form A contact	Operates the contactor for shutting down the inverter output.																																																																																									
BKA/ BKC	Brake operation relay Form A contact	Operates the traction machine brake.																																																																																										
Fault output	D1	Fault information BIT0 (LSB)	Outputs 4-bit fault data when the inverter is malfunctioning. Elevator faults have priority in the output over inverter faults. Set one of the multifunction outputs AX1 – AX4 to “E/L Fault” to distinguish elevator faults from inverter faults. When a fault occurs, it is an elevator fault if the multifunction terminal set to “E/L Fault” is ON; it is an inverter fault if the multifunction terminal set to “E/L Fault” is OFF. <Output codes for elevator faults>																																																																																									
	D2	Fault data BIT 1	<table border="1"> <thead> <tr> <th>Fault</th> <th>D4</th> <th>D3</th> <th>D2</th> <th>D1</th> </tr> </thead> <tbody> <tr><td>No Fault</td><td>OFF</td><td>OFF</td><td>OFF</td><td>OFF</td></tr> <tr><td>FHM RUN Fail</td><td>OFF</td><td>OFF</td><td>OFF</td><td>ON</td></tr> <tr><td>Flr Data Fail</td><td>OFF</td><td>OFF</td><td>ON</td><td>OFF</td></tr> <tr><td>ChkSum Err</td><td>OFF</td><td>OFF</td><td>ON</td><td>ON</td></tr> <tr><td>NotRdy (E/L)</td><td>OFF</td><td>ON</td><td>OFF</td><td>OFF</td></tr> <tr><td>Decel</td><td>OFF</td><td>ON</td><td>OFF</td><td>ON</td></tr> <tr><td>Acc/Dec</td><td>OFF</td><td>ON</td><td>ON</td><td>OFF</td></tr> <tr><td>SDS Error</td><td>OFF</td><td>ON</td><td>ON</td><td>ON</td></tr> <tr><td>IND Reverved</td><td>ON</td><td>OFF</td><td>OFF</td><td>OFF</td></tr> <tr><td>Indicator Fail</td><td>ON</td><td>OFF</td><td>OFF</td><td>ON</td></tr> <tr><td>CmdSrc</td><td>ON</td><td>OFF</td><td>ON</td><td>OFF</td></tr> <tr><td>NotRdy (FHM)</td><td>ON</td><td>OFF</td><td>ON</td><td>ON</td></tr> </tbody> </table>	Fault	D4	D3	D2	D1	No Fault	OFF	OFF	OFF	OFF	FHM RUN Fail	OFF	OFF	OFF	ON	Flr Data Fail	OFF	OFF	ON	OFF	ChkSum Err	OFF	OFF	ON	ON	NotRdy (E/L)	OFF	ON	OFF	OFF	Decel	OFF	ON	OFF	ON	Acc/Dec	OFF	ON	ON	OFF	SDS Error	OFF	ON	ON	ON	IND Reverved	ON	OFF	OFF	OFF	Indicator Fail	ON	OFF	OFF	ON	CmdSrc	ON	OFF	ON	OFF	NotRdy (FHM)	ON	OFF	ON	ON																								
	Fault	D4	D3	D2	D1																																																																																							
	No Fault	OFF	OFF	OFF	OFF																																																																																							
	FHM RUN Fail	OFF	OFF	OFF	ON																																																																																							
Flr Data Fail	OFF	OFF	ON	OFF																																																																																								
ChkSum Err	OFF	OFF	ON	ON																																																																																								
NotRdy (E/L)	OFF	ON	OFF	OFF																																																																																								
Decel	OFF	ON	OFF	ON																																																																																								
Acc/Dec	OFF	ON	ON	OFF																																																																																								
SDS Error	OFF	ON	ON	ON																																																																																								
IND Reverved	ON	OFF	OFF	OFF																																																																																								
Indicator Fail	ON	OFF	OFF	ON																																																																																								
CmdSrc	ON	OFF	ON	OFF																																																																																								
NotRdy (FHM)	ON	OFF	ON	ON																																																																																								
D3	Fault data BIT 2	<Output codes for inverter faults> <table border="1"> <thead> <tr> <th>Fault</th> <th>D4</th> <th>D3</th> <th>D2</th> <th>D1</th> </tr> </thead> <tbody> <tr><td>No Fault</td><td>OFF</td><td>OFF</td><td>OFF</td><td>OFF</td></tr> <tr><td>Arm Short</td><td>OFF</td><td>OFF</td><td>OFF</td><td>ON</td></tr> <tr><td>FAN Error</td><td>OFF</td><td>OFF</td><td>ON</td><td>OFF</td></tr> <tr><td>Ground Fault</td><td>OFF</td><td>OFF</td><td>ON</td><td>ON</td></tr> <tr><td>Over Current</td><td>OFF</td><td>ON</td><td>OFF</td><td>OFF</td></tr> <tr><td>Over Voltage</td><td>OFF</td><td>ON</td><td>OFF</td><td>ON</td></tr> <tr><td>Encoder Err / EnDat Error</td><td>OFF</td><td>ON</td><td>ON</td><td>OFF</td></tr> <tr><td>Low Voltage / Low Voltage2</td><td>OFF</td><td>ON</td><td>ON</td><td>ON</td></tr> <tr><td>Inv OverHeat</td><td>ON</td><td>OFF</td><td>OFF</td><td>OFF</td></tr> <tr><td>E-Thermal / Over Load</td><td>ON</td><td>OFF</td><td>OFF</td><td>ON</td></tr> <tr><td>Input PO / Output PO</td><td>ON</td><td>OFF</td><td>ON</td><td>OFF</td></tr> <tr><td>Ext. Trip-B</td><td>ON</td><td>OFF</td><td>ON</td><td>ON</td></tr> <tr><td>Inv. OLT</td><td>ON</td><td>ON</td><td>OFF</td><td>OFF</td></tr> <tr><td>Mag Det Err</td><td>ON</td><td>ON</td><td>OFF</td><td>ON</td></tr> <tr><td>InvThem OP</td><td>ON</td><td>ON</td><td>ON</td><td>OFF</td></tr> <tr><td>Over Speed</td><td>ON</td><td>ON</td><td>ON</td><td>ON</td></tr> <tr><td>Spd Dev Err</td><td>ON</td><td>ON</td><td>ON</td><td>ON</td></tr> </tbody> </table>	Fault	D4	D3	D2	D1	No Fault	OFF	OFF	OFF	OFF	Arm Short	OFF	OFF	OFF	ON	FAN Error	OFF	OFF	ON	OFF	Ground Fault	OFF	OFF	ON	ON	Over Current	OFF	ON	OFF	OFF	Over Voltage	OFF	ON	OFF	ON	Encoder Err / EnDat Error	OFF	ON	ON	OFF	Low Voltage / Low Voltage2	OFF	ON	ON	ON	Inv OverHeat	ON	OFF	OFF	OFF	E-Thermal / Over Load	ON	OFF	OFF	ON	Input PO / Output PO	ON	OFF	ON	OFF	Ext. Trip-B	ON	OFF	ON	ON	Inv. OLT	ON	ON	OFF	OFF	Mag Det Err	ON	ON	OFF	ON	InvThem OP	ON	ON	ON	OFF	Over Speed	ON	ON	ON	ON	Spd Dev Err	ON	ON	ON	ON
Fault	D4	D3	D2	D1																																																																																								
No Fault	OFF	OFF	OFF	OFF																																																																																								
Arm Short	OFF	OFF	OFF	ON																																																																																								
FAN Error	OFF	OFF	ON	OFF																																																																																								
Ground Fault	OFF	OFF	ON	ON																																																																																								
Over Current	OFF	ON	OFF	OFF																																																																																								
Over Voltage	OFF	ON	OFF	ON																																																																																								
Encoder Err / EnDat Error	OFF	ON	ON	OFF																																																																																								
Low Voltage / Low Voltage2	OFF	ON	ON	ON																																																																																								
Inv OverHeat	ON	OFF	OFF	OFF																																																																																								
E-Thermal / Over Load	ON	OFF	OFF	ON																																																																																								
Input PO / Output PO	ON	OFF	ON	OFF																																																																																								
Ext. Trip-B	ON	OFF	ON	ON																																																																																								
Inv. OLT	ON	ON	OFF	OFF																																																																																								
Mag Det Err	ON	ON	OFF	ON																																																																																								
InvThem OP	ON	ON	ON	OFF																																																																																								
Over Speed	ON	ON	ON	ON																																																																																								
Spd Dev Err	ON	ON	ON	ON																																																																																								
D4	Fault data BIT 3	<table border="1"> <thead> <tr> <th>Fault</th> <th>D4</th> <th>D3</th> <th>D2</th> <th>D1</th> </tr> </thead> <tbody> <tr><td>No Fault</td><td>OFF</td><td>OFF</td><td>OFF</td><td>OFF</td></tr> <tr><td>Arm Short</td><td>OFF</td><td>OFF</td><td>OFF</td><td>ON</td></tr> <tr><td>FAN Error</td><td>OFF</td><td>OFF</td><td>ON</td><td>OFF</td></tr> <tr><td>Ground Fault</td><td>OFF</td><td>OFF</td><td>ON</td><td>ON</td></tr> <tr><td>Over Current</td><td>OFF</td><td>ON</td><td>OFF</td><td>OFF</td></tr> <tr><td>Over Voltage</td><td>OFF</td><td>ON</td><td>OFF</td><td>ON</td></tr> <tr><td>Encoder Err / EnDat Error</td><td>OFF</td><td>ON</td><td>ON</td><td>OFF</td></tr> <tr><td>Low Voltage / Low Voltage2</td><td>OFF</td><td>ON</td><td>ON</td><td>ON</td></tr> <tr><td>Inv OverHeat</td><td>ON</td><td>OFF</td><td>OFF</td><td>OFF</td></tr> <tr><td>E-Thermal / Over Load</td><td>ON</td><td>OFF</td><td>OFF</td><td>ON</td></tr> <tr><td>Input PO / Output PO</td><td>ON</td><td>OFF</td><td>ON</td><td>OFF</td></tr> <tr><td>Ext. Trip-B</td><td>ON</td><td>OFF</td><td>ON</td><td>ON</td></tr> <tr><td>Inv. OLT</td><td>ON</td><td>ON</td><td>OFF</td><td>OFF</td></tr> <tr><td>Mag Det Err</td><td>ON</td><td>ON</td><td>OFF</td><td>ON</td></tr> <tr><td>InvThem OP</td><td>ON</td><td>ON</td><td>ON</td><td>OFF</td></tr> <tr><td>Over Speed</td><td>ON</td><td>ON</td><td>ON</td><td>ON</td></tr> <tr><td>Spd Dev Err</td><td>ON</td><td>ON</td><td>ON</td><td>ON</td></tr> </tbody> </table>	Fault	D4	D3	D2	D1	No Fault	OFF	OFF	OFF	OFF	Arm Short	OFF	OFF	OFF	ON	FAN Error	OFF	OFF	ON	OFF	Ground Fault	OFF	OFF	ON	ON	Over Current	OFF	ON	OFF	OFF	Over Voltage	OFF	ON	OFF	ON	Encoder Err / EnDat Error	OFF	ON	ON	OFF	Low Voltage / Low Voltage2	OFF	ON	ON	ON	Inv OverHeat	ON	OFF	OFF	OFF	E-Thermal / Over Load	ON	OFF	OFF	ON	Input PO / Output PO	ON	OFF	ON	OFF	Ext. Trip-B	ON	OFF	ON	ON	Inv. OLT	ON	ON	OFF	OFF	Mag Det Err	ON	ON	OFF	ON	InvThem OP	ON	ON	ON	OFF	Over Speed	ON	ON	ON	ON	Spd Dev Err	ON	ON	ON	ON
Fault	D4	D3	D2	D1																																																																																								
No Fault	OFF	OFF	OFF	OFF																																																																																								
Arm Short	OFF	OFF	OFF	ON																																																																																								
FAN Error	OFF	OFF	ON	OFF																																																																																								
Ground Fault	OFF	OFF	ON	ON																																																																																								
Over Current	OFF	ON	OFF	OFF																																																																																								
Over Voltage	OFF	ON	OFF	ON																																																																																								
Encoder Err / EnDat Error	OFF	ON	ON	OFF																																																																																								
Low Voltage / Low Voltage2	OFF	ON	ON	ON																																																																																								
Inv OverHeat	ON	OFF	OFF	OFF																																																																																								
E-Thermal / Over Load	ON	OFF	OFF	ON																																																																																								
Input PO / Output PO	ON	OFF	ON	OFF																																																																																								
Ext. Trip-B	ON	OFF	ON	ON																																																																																								
Inv. OLT	ON	ON	OFF	OFF																																																																																								
Mag Det Err	ON	ON	OFF	ON																																																																																								
InvThem OP	ON	ON	ON	OFF																																																																																								
Over Speed	ON	ON	ON	ON																																																																																								
Spd Dev Err	ON	ON	ON	ON																																																																																								
EG	COMMON	Common ground for open collector outputs for faults.																																																																																										

LCD Keypad



Type	Description
LCEN-L100	LCD Keypad with L100 Remote Connection (I/V5 Common)

L100 Keypad Remote Cable

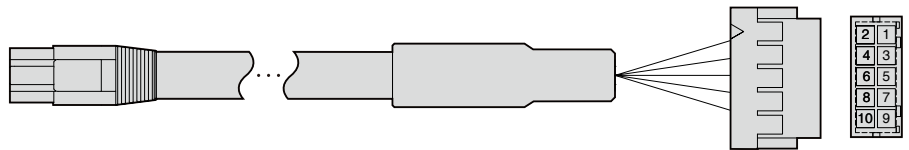

Type	Description
A2MT-L100	L100 LCD Keypad Remote Cable, 2m
A3MT-L100	L100 LCD Keypad Remote Cable, 3m
A5MT-L100	L100 LCD Keypad Remote Cable, 5m

※ LCD Keypad and Remote Cable are composed of a set

L100 RS232 COM Cable

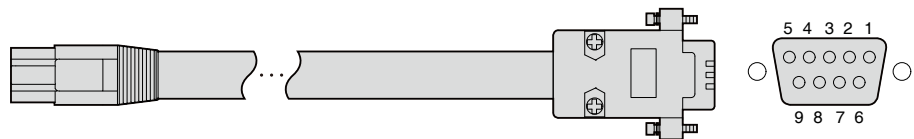

Type	Description
S2MT-L100	L100 RS232 to COM connection cable, 2m

Compatible Circuit Breaker, Leakage Breaker and Magnetic Contactor Models (Manufactured by LS ELECTRIC)

Motor Capacity(kW)	Drive Type	Circuit Breaker / Leakage Breaker	Magnetic Contactor
5.5	LSLV055L100-4	TD125U/30A, EBS33b30A	MC-32a
7.5	LSLV075L100-4	TD125U30A, EBS33b30A	MC-32a
11	LSLV110L100-4	TD125U/50A, EBS53b50A	MC-40a
15	LSLV150L100-4	TD125U/60A, EBS103b60A	MC-50a
18.5	LSLV185L100-4	TD125U/80A, EBS103b80A	MC-65a
22	LSLV220L100-4	TD125U/100A, EBS103b100A	MC-65a

※ For detailed order types, refer to the circuit breakers and earth leakage breakers catalog.

AC Input Fuse, AC Reactor and DC Reactor Specifications

Motor Capacity(kW)	Drive Type	AC Input Fuse	AC Reactor	DC Reactor
5.5	LSLV055L100-4	32 A, 600V	1.22 mH, 19 A	3.20 mH, 17 A
7.5	LSLV075L100-4	35 A, 600V	0.78 mH, 27 A	2.50 mH, 25 A
11	LSLV110L100-4	50 A, 600V	0.59 mH, 35 A	1.90 mH, 32 A
15	LSLV150L100-4	63 A, 600V	0.46 mH, 44 A	1.40 mH, 41 A
18.5	LSLV185L100-4	70 A, 600V	0.40 mH, 52 A	1.00 mH, 49 A
22	LSLV220L100-4	100 A, 600V	0.30 mH, 68 A	0.70 mH, 64 A

※ The peripheral devices cannot be used if the symmetrical current exceed 35kA at the drive maximum rated voltage.

Braking Resistor Specifications

The standard for braking torque is 150% and the working rate (%ED) is 5%^{Note 1}.
If the working rate is 10%, the rated capacity for braking resistance must be calculated at twice the standard.

Drive Type	Capacity (5% ED)	
	[Ω]	[W] ^{Note 2}
LSLV055L100-4	85	800
LSLV075L100-4	60	1200
LSLV110L100-4	40	2400
LSLV150L100-4	30	2400
LSLV185L100-4	20	3600
LSLV220L100-4	20	3600

Note 1) ED is based on 100 seconds.

Note 2) Rated capacity is based on the self-cooled type.

Braking Resistor Wiring

A temperature sensor is installed to the LS braking resistor to prevent fire.
Refer to the followings when using the braking resistor.

Terminal type	Terminals on the braking resistor	Terminals on the inverter	Operation
Power	B1, B2	P2(+), B	-
Control	T1, T2	P7, CM	Define one of multifunction input terminals (P1-P7) on the control terminal as "external trip signal contact B". The contact is ON in a room temperature and becomes OFF when overheated.

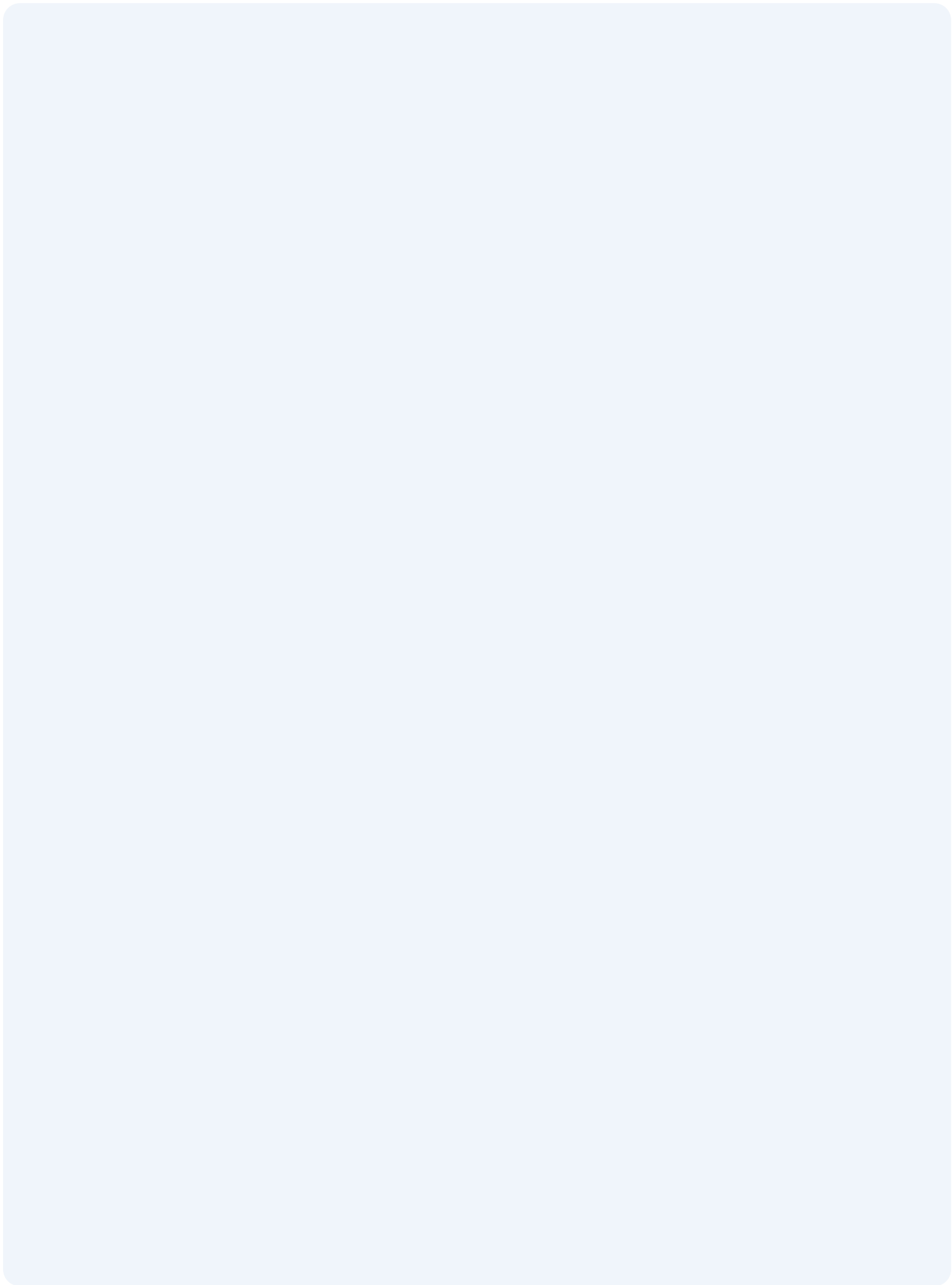



Safety Instructions

- For your safety, please read user's manual thoroughly before operating.
- Contact the nearest authorized service facility for examination, repair, or adjustment.
- Please contact qualified service technician when you need maintenance. Do not disassemble or repair by yourself!
- Any maintenance and inspection shall be performed by the personnel having expertise concerned.



- According to The WEEE Directive, please do not discard the device with your household waste.



www.ls-electric.com

■ Headquarter

LS-ro 127(Hogye-dong) Dongan-gu, Anyang-si, Gyeonggi-Do, 14119, Korea

■ Seoul Office

LS Yongsan Tower, 92, Hangang-daero, Yongsan-gu, Seoul, 04386, Korea
Tel: 82-2-2034-4644(Europe), 4982(USA), 4884(East Asia)
Fax: 82-2-2034-4588 E-mail: drivesales@ls-electric.com

■ Overseas Subsidiaries

- **LS ELECTRIC Japan Co., Ltd. (Tokyo, Japan)**
Tel: 81-3-6268-8241 E-Mail: japan@ls-electric.com
- **LS ELECTRIC (Dalian) Co., Ltd. (Dalian, China)**
Tel: 86-411-8730-6495 E-Mail: china.dalian@lselectric.com.cn
- **LS ELECTRIC (Wuxi) Co., Ltd. (Wuxi, China)**
Tel: 86-510-6851-6666 E-Mail: china.wuxi@lselectric.com.cn
- **LS ELECTRIC Middle East FZE (Dubai, U.A.E.)**
Tel: 971-4-886-5360 E-Mail: middleeast@ls-electric.com
- **LS ELECTRIC Europe B.V. (Hoofddorp, Netherlands)**
Tel: 31-20-654-1424 E-Mail: europartner@ls-electric.com
- **LS ELECTRIC America Inc. (Chicago, USA)**
Tel: 1-800-891-2941 E-Mail: sales.us@lselectricamerica.com
- **LS ELECTRIC Turkey Co., Ltd.**
Tel: 90-212-806-1225 E-Mail: turkey@ls-electric.com

■ Overseas Branches

- **LS ELECTRIC Tokyo Office (Japan)**
Tel: 81-3-6268-8241 E-Mail: tokyo@ls-electric.com
- **LS ELECTRIC Beijing Office (China)**
Tel: 86-10-5095-1631 E-Mail: china.auto@lselectric.com.cn
- **LS ELECTRIC Shanghai Office (China)**
Tel: 86-21-5237-9977 E-Mail: china.auto@lselectric.com.cn
- **LS ELECTRIC Guangzhou Office (China)**
Tel: 86-20-3818-2883 E-Mail: china.auto@lselectric.com.cn
- **LS ELECTRIC Chengdu Office (China)**
Tel: 86-28-8670-3201 E-Mail: china.auto@lselectric.com.cn
- **LS ELECTRIC Qingdao Office (China)**
Tel: 86-532-8501-2065 E-Mail: china.auto@lselectric.com.cn
- **LS ELECTRIC Nanjing Office (China)**
Tel: 86-25-8467-0005 E-Mail: china.auto@lselectric.com.cn
- **LS ELECTRIC Bangkok Office (Thailand)**
Tel: 66-90-950-9683 E-Mail: thailand@ls-electric.com
- **LS ELECTRIC Jakarta Office (Indonesia)**
Tel: 62-21-2933-7614 E-Mail: indonesia@ls-electric.com
- **LS ELECTRIC Moscow Office (Russia)**
Tel: 7-499-682-6130 E-Mail: info@lselectric-ru.com
- **LS ELECTRIC America Western Office (Irvine, USA)**
Tel: 1-949-333-3140 E-Mail: america@ls-electric.com
- **LS ELECTRIC Italy office (Italy)**
Tel: 39-030-8081-833 E-Mail: italia@ls-electric.com